



ON Semiconductor®

# FDD6N50TM-F085

## 500V N-Channel MOSFET

### Features

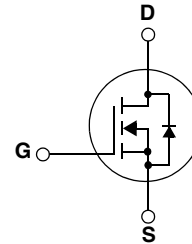
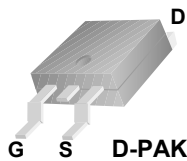
- 6A, 500V,  $R_{DS(on)} = 0.9\Omega @ V_{GS} = 10V$
- Low gate charge ( typical 12.8 nC)
- Low  $C_{rss}$  ( typical 9 pF)
- Fast switching
- 100% avalanche tested
- Improved dv/dt capability
- Qualified to AEC Q101
- RoHS Compliant



### Description

These N-Channel enhancement mode power field effect transistors are produced using ON Semiconductor's proprietary, planar stripe, DMOS technology.

This advanced technology has been especially tailored to minimize on-state resistance, provide superior switching performance, and withstand high energy pulse in the avalanche and commutation mode. These devices are well suited for high efficient switched mode power supplies and active power factor correction.



### Absolute Maximum Ratings

| Symbol         | Parameter   | Ratings   | Unit                    |
|----------------|---|---|-------------------------|
| $V_{DSS}$      | Drain-Source Voltage  | 500   | V                       |
| $I_D$          | Drain Current   | - Continuous ( $T_C = 25^\circ C$ )<br>- Continuous ( $T_C = 100^\circ C$ ) | 6<br>3.8<br>A<br>A      |
| $I_{DM}$       | Drain Current   | - Pulsed (Note 1)   | 24<br>A                 |
| $V_{GSS}$      | Gate-Source voltage   | $\pm 30$  | V                       |
| $E_{AS}$       | Single Pulsed Avalanche Energy  | (Note 2)  | 270<br>mJ               |
| $I_{AR}$       | Avalanche Current   | (Note 1)  | 6<br>A                  |
| $E_{AR}$       | Repetitive Avalanche Energy   | (Note 1)  | 8.9<br>mJ               |
| dv/dt          | Peak Diode Recovery dv/dt   | (Note 3)  | 4.5<br>V/ns             |
| $P_D$          | Power Dissipation   | ( $T_C = 25^\circ C$ )<br>- Derate above $25^\circ C$                       | 89<br>0.71<br>W<br>W/°C |
| $T_J, T_{STG}$ | Operating and Storage Temperature Range   | -55 to +150   | °C                      |
| $T_L$          | Maximum Lead Temperature for Soldering Purpose,<br>1/8" from Case for 5 Seconds | 300   | °C                      |

### Thermal Characteristics

| Symbol          | Parameter                               | Min. | Max. | Unit |
|-----------------|---|------|------|------|
| $R_{\theta JC}$ | Thermal Resistance, Junction-to-Case    | --   | 1.4  | °C/W |
| $R_{\theta JA}$ | Thermal Resistance, Junction-to-Ambient | --   | 83   | °C/W |

FDD6N50TM-F085 500V N-Channel MOSFET

## Package Marking and Ordering Information

| Device Marking | Device         | Package | Reel Size | Tape Width | Quantity |
|----------------|----------------|---------|-----------|------------|----------|
| FDD6N50        | FDD6N50TM-F085 | D-PAK   | 380mm     | 16mm       | 2500     |

## Electrical Characteristics T<sub>C</sub> = 25°C unless otherwise noted

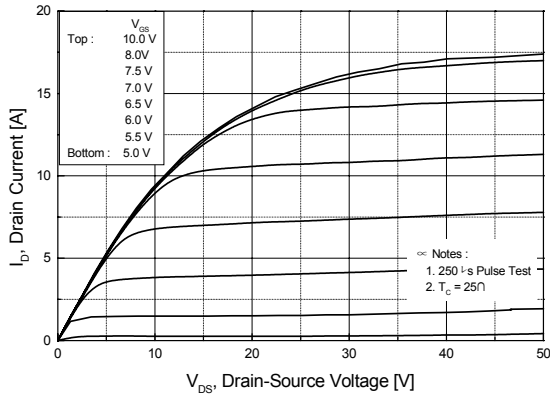
| Symbol  | Parameter   | Conditions   | Min.        | Typ. | Max     | Units              |
|---|---|--|-------------|------|---------|--------------------|
| <b>Off Characteristics</b>                                    |   |  |             |      |         |                    |
| $BV_{DSS}$  | Drain-Source Breakdown Voltage                        | $V_{GS} = 0V, I_D = 250\mu A$                                      | 500         | --   | --      | V                  |
| $\frac{\Delta BV_{DSS}}{\Delta T_J}$                          | Breakdown Voltage Temperature Coefficient             | $I_D = 250\mu A$ , Referenced to 25°C                              | --          | 0.5  | --      | V/°C               |
| $I_{DSS}$   | Zero Gate Voltage Drain Current                       | $V_{DS} = 500V, V_{GS} = 0V$<br>$V_{DS} = 400V, T_C = 125^\circ C$ | --          | --   | 1<br>10 | $\mu A$<br>$\mu A$ |
| $I_{GSSF}$  | Gate-Body Leakage Current, Forward                    | $V_{GS} = 30V, V_{DS} = 0V$  | --          | --   | 100     | nA                 |
| $I_{GSSR}$  | Gate-Body Leakage Current, Reverse                    | $V_{GS} = -30V, V_{DS} = 0V$                                       | --          | --   | -100    | nA                 |
| <b>On Characteristics</b>                                     |   |  |             |      |         |                    |
| $V_{GS(th)}$  | Gate Threshold Voltage                                | $V_{DS} = V_{GS}, I_D = 250\mu A$                                  | 3.0         | --   | 5.0     | V                  |
| $R_{DS(on)}$  | Static Drain-Source On-Resistance                     | $V_{GS} = 10V, I_D = 3A$   | --          | 0.76 | 0.9     | $\Omega$           |
| $g_{FS}$  | Forward Transconductance                              | $V_{DS} = 40V, I_D = 3A$ (Note 4)                                  | --          | 2.5  | --      | S                  |
| <b>Dynamic Characteristics</b>                                |   |  |             |      |         |                    |
| $C_{iss}$   | Input Capacitance                                     | $V_{DS} = 25V, V_{GS} = 0V,$<br>$f = 1.0MHz$                       | --          | 720  | 940     | pF                 |
| $C_{oss}$   | Output Capacitance                                    |  | --          | 95   | 190     | pF                 |
| $C_{rss}$   | Reverse Transfer Capacitance                          |  | --          | 9    | 13.5    | pF                 |
| <b>Switching Characteristics</b>                              |   |  |             |      |         |                    |
| $t_{d(on)}$   | Turn-On Delay Time                                    | $V_{DD} = 250V, I_D = 6A$<br>$R_G = 25\Omega$                      | --          | 6    | 20      | ns                 |
| $t_r$   | Turn-On Rise Time                                     |  | --          | 55   | 120     | ns                 |
| $t_{d(off)}$  | Turn-Off Delay Time                                   |  | --          | 25   | 60      | ns                 |
| $t_f$   | Turn-Off Fall Time                                    |  | (Note 4, 5) | --   | 35      | 80                 |
| $Q_g$   | Total Gate Charge                                     | $V_{DS} = 400V, I_D = 6A$<br>$V_{GS} = 10V$                        | --          | 12.8 | 16.6    | nC                 |
| $Q_{gs}$  | Gate-Source Charge                                    |  | --          | 3.7  | --      | nC                 |
| $Q_{gd}$  | Gate-Drain Charge                                     |  | (Note 4, 5) | --   | 5.8     | --                 |
| <b>Drain-Source Diode Characteristics and Maximum Ratings</b> |   |  |             |      |         |                    |
| $I_S$   | Maximum Continuous Drain-Source Diode Forward Current |  | --          | --   | 6       | A                  |
| $I_{SM}$  | Maximum Pulsed Drain-Source Diode Forward Current     |  | --          | --   | 24      | A                  |
| $V_{SD}$  | Drain-Source Diode Forward Voltage                    | $V_{GS} = 0V, I_S = 6A$  | --          | --   | 1.4     | V                  |
| $t_{rr}$  | Reverse Recovery Time                                 | $V_{GS} = 0V, I_S = 6A$<br>$di_f/dt = 100A/\mu s$                  | --          | 275  | --      | ns                 |
| $Q_{rr}$  | Reverse Recovery Charge                               |  | (Note 4)    | --   | 1.7     | --                 |

### NOTES:

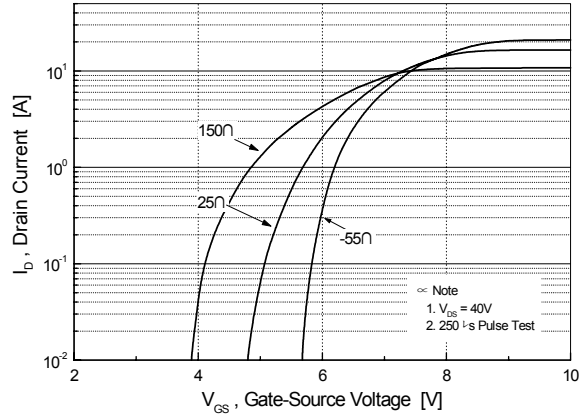
1. Repetitive Rating: Pulse width limited by maximum junction temperature
2.  $I_{AS} = 6A, V_{DD} = 50V, L = 13.5mH, R_G = 25\Omega$ , Starting  $T_J = 25^\circ C$
3.  $I_{SD} \leq 6A, di/dt \leq 200A/\mu s, V_{DD} \leq BV_{DSS}$ , Starting  $T_J = 25^\circ C$
4. Pulse Test: Pulse width  $\leq 300\mu s$ , Duty Cycle  $\leq 2\%$
5. Essentially Independent of Operating Temperature Typical Characteristics

## Typical Performance Characteristics

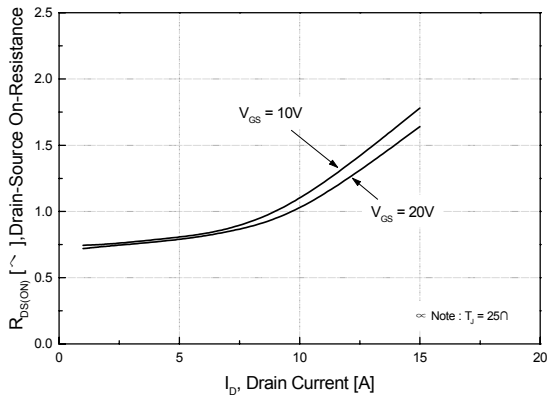
**Figure 1. On-Region Characteristics**



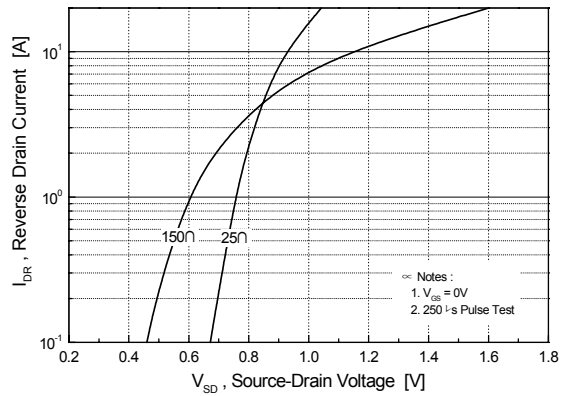
**Figure 2. Transfer Characteristics**



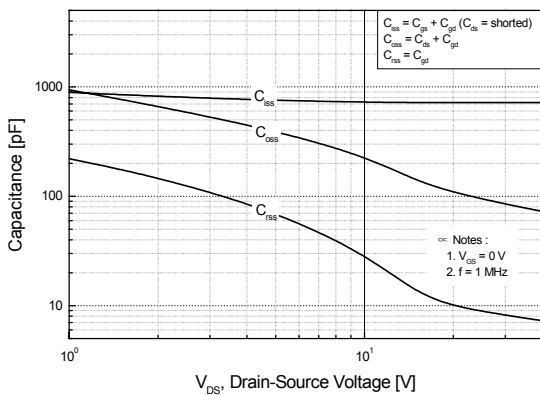
**Figure 3. On-Resistance Variation vs. Drain Current and Gate Voltage**



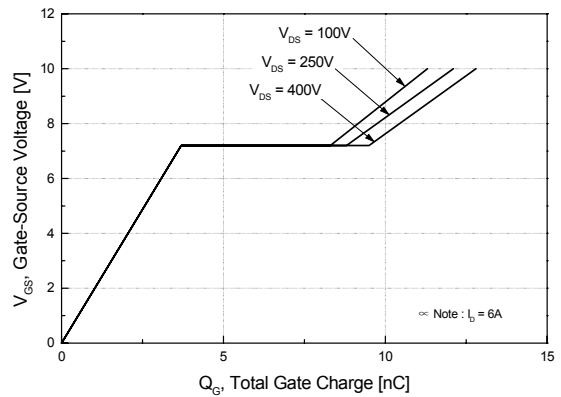
**Figure 4. Body Diode Forward Voltage Variation vs. Source Current and Temperature**



**Figure 5. Capacitance Characteristics**

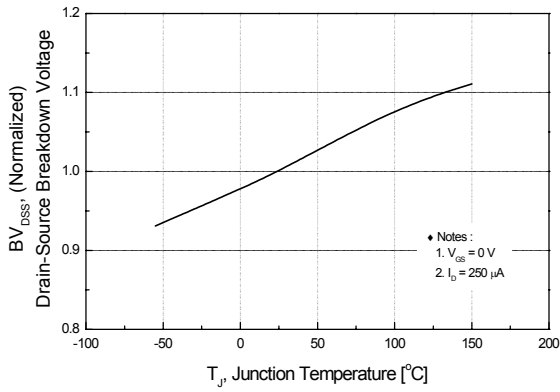


**Figure 6. Gate Charge Characteristics**

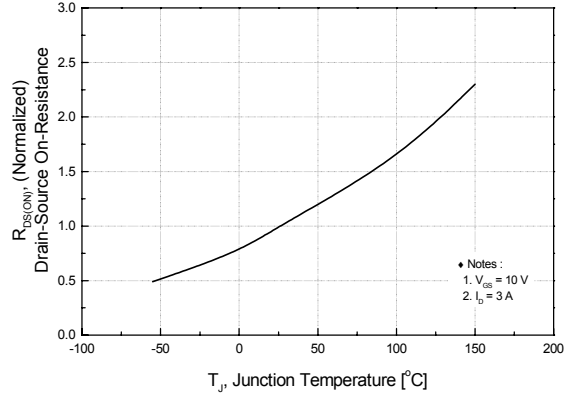


## Typical Performance Characteristics (Continued)

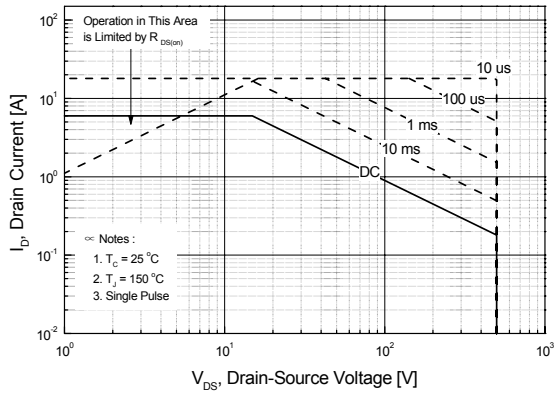
**Figure 7. Breakdown Voltage Variation vs. Temperature**



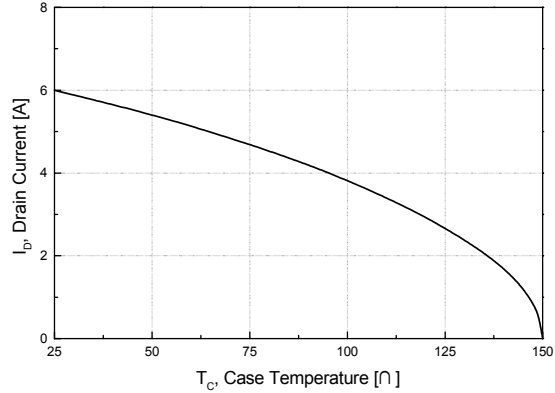
**Figure 8. On-Resistance Variation vs. Temperature**



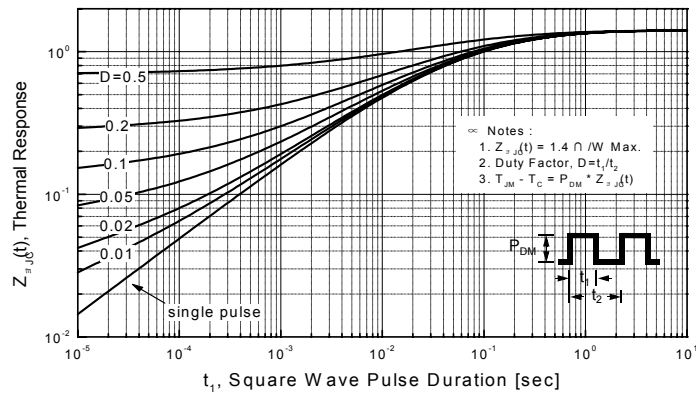
**Figure 9. Maximum Safe Operating Area**



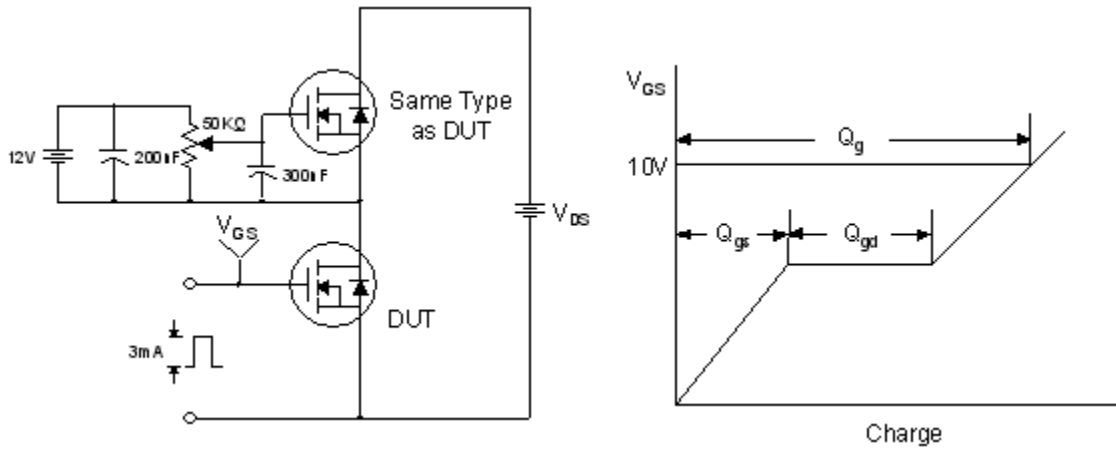
**Figure 10. Maximum Drain Current vs. Case Temperature**



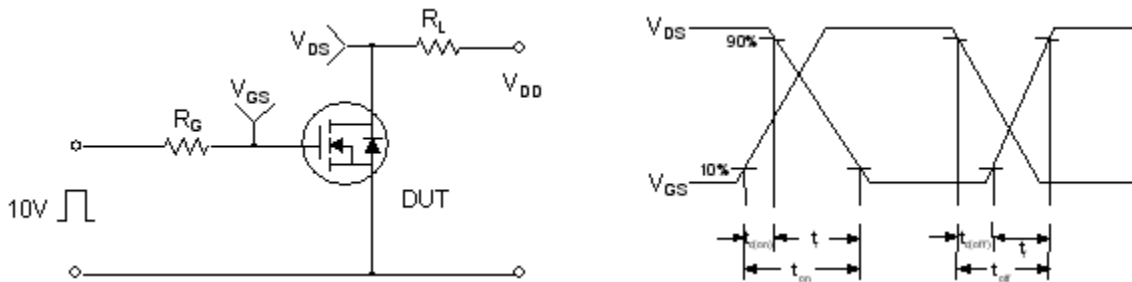
**Figure 11. Transient Thermal Response Curve**



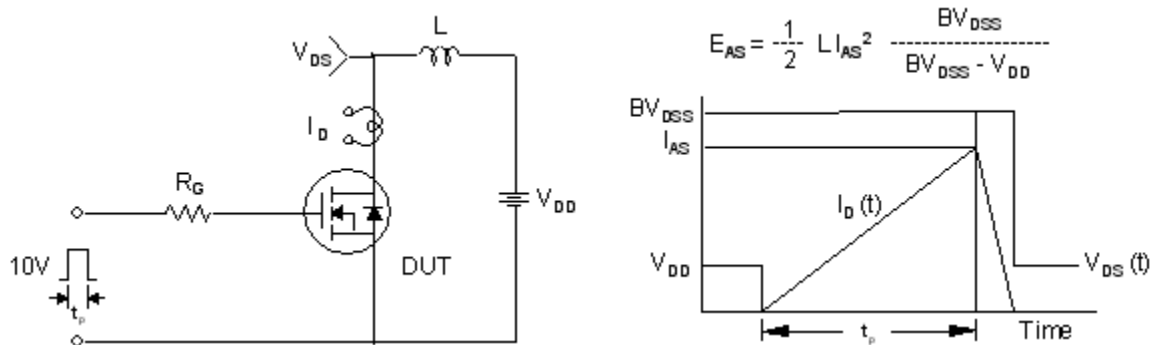
**Gate Charge Test Circuit & Waveform**



**Resistive Switching Test Circuit & Waveforms**



**Unclamped Inductive Switching Test Circuit & Waveforms**

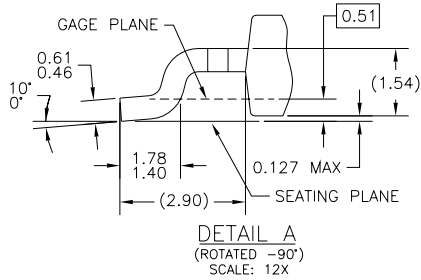
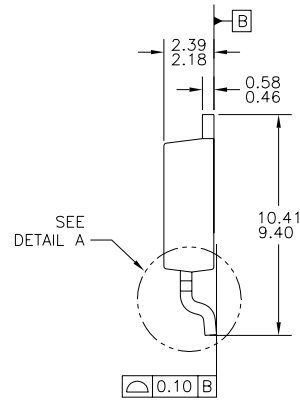
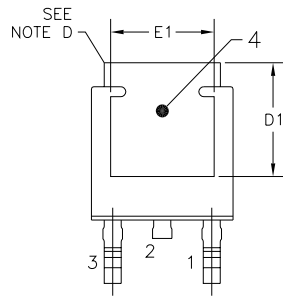
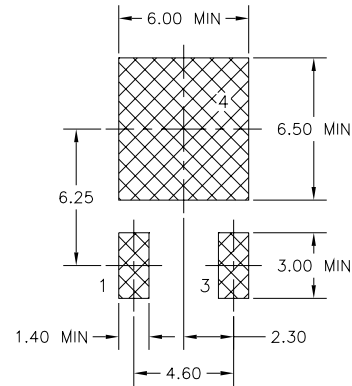
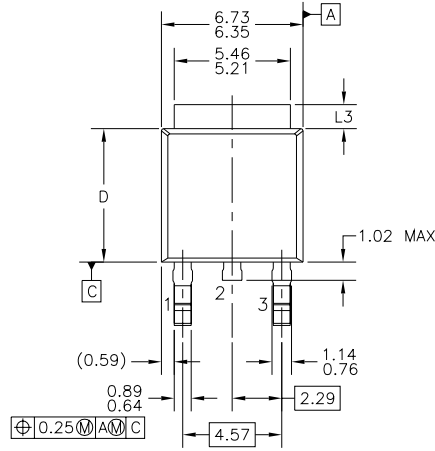


**Peak Diode Recovery dv/dt Test Circuit & Waveforms**



# Mechanical Dimensions

## D-PAK



- NOTES: UNLESS OTHERWISE SPECIFIED
- A) ALL DIMENSIONS ARE IN MILLIMETERS.
  - B) THIS PACKAGE CONFORMS TO JEDEC, TO-252, ISSUE C, VARIATION AA & AB, DATED NOV. 1999.
  - C) DIMENSIONING AND TOLERANCING PER ASME Y14.5M-1994.
  - D) HEAT SINK TOP EDGE COULD BE IN CHAMFERED CORNERS OR EDGE PROTRUSION.
  - E) DIMENSIONS L3,D,E1&D1 TABLE:
- |    | OPTION AA | OPTION AB |
|----|-----------|-----------|
| L3 | 0.89-1.27 | 1.52-2.03 |
| D  | 5.97-6.22 | 5.33-5.59 |
| E1 | 4.32 MIN  | 3.81 MIN  |
| D1 | 5.21 MIN  | 4.57 MIN  |
- F) PRESENCE OF TRIMMED CENTER LEAD IS OPTIONAL.

Dimensions in Millimeters

ON Semiconductor and  are trademarks of Semiconductor Components Industries, LLC dba ON Semiconductor or its subsidiaries in the United States and/or other countries. ON Semiconductor owns the rights to a number of patents, trademarks, copyrights, trade secrets, and other intellectual property. A listing of ON Semiconductor's product/patent coverage may be accessed at [www.onsemi.com/site/pdf/Patent-Marking.pdf](http://www.onsemi.com/site/pdf/Patent-Marking.pdf). ON Semiconductor reserves the right to make changes without further notice to any products herein. ON Semiconductor makes no warranty, representation or guarantee regarding the suitability of its products for any particular purpose, nor does ON Semiconductor assume any liability arising out of the application or use of any product or circuit, and specifically disclaims any and all liability, including without limitation special, consequential or incidental damages. Buyer is responsible for its products and applications using ON Semiconductor products, including compliance with all laws, regulations and safety requirements or standards, regardless of any support or applications information provided by ON Semiconductor. "Typical" parameters which may be provided in ON Semiconductor data sheets and/or specifications can and do vary in different applications and actual performance may vary over time. All operating parameters, including "Typicals" must be validated for each customer application by customer's technical experts. ON Semiconductor does not convey any license under its patent rights nor the rights of others. ON Semiconductor products are not designed, intended, or authorized for use as a critical component in life support systems or any FDA Class 3 medical devices or medical devices with a same or similar classification in a foreign jurisdiction or any devices intended for implantation in the human body. Should Buyer purchase or use ON Semiconductor products for any such unintended or unauthorized application, Buyer shall indemnify and hold ON Semiconductor and its officers, employees, subsidiaries, affiliates, and distributors harmless against all claims, costs, damages, and expenses, and reasonable attorney fees arising out of, directly or indirectly, any claim of personal injury or death associated with such unintended or unauthorized use, even if such claim alleges that ON Semiconductor was negligent regarding the design or manufacture of the part. ON Semiconductor is an Equal Opportunity/Affirmative Action Employer. This literature is subject to all applicable copyright laws and is not for resale in any manner.

## PUBLICATION ORDERING INFORMATION

### LITERATURE FULFILLMENT:

Literature Distribution Center for ON Semiconductor  
19521 E. 32nd Pkwy, Aurora, Colorado 80011 USA  
**Phone:** 303-675-2175 or 800-344-3860 Toll Free USA/Canada  
**Fax:** 303-675-2176 or 800-344-3867 Toll Free USA/Canada  
**Email:** [orderlit@onsemi.com](mailto:orderlit@onsemi.com)

**N. American Technical Support:** 800-282-9855 Toll Free  
USA/Canada  
**Europe, Middle East and Africa Technical Support:**  
Phone: 421 33 790 2910  
**Japan Customer Focus Center**  
Phone: 81-3-5817-1050

**ON Semiconductor Website:** [www.onsemi.com](http://www.onsemi.com)  
**Order Literature:** <http://www.onsemi.com/orderlit>  
For additional information, please contact your local  
Sales Representative