



Product Change Notification

Current Date: 30-Oct-2019

TE Connectivity

Product Change Notification: E-19-014888

PCN Date: 28-OCT-19

Customer: TTI, Inc. (1305175)

Location: Maisach-gernlinden

Agreement: TTI001

TE would like to inform you of the following change(s) to the listed TE Connectivity Product. In case of any further questions about this change(s), please contact your TE Connectivity Sales Engineer. Affected part, drawing and/or specification numbers are listed on the attached sheet(s).

General Product Description:

RECEPTACLE HOUSING MICRO MNL, DOUBLE AND SINGLE ROW.

Description of Changes

NEW DASHES ADDED AND DASHES ACTIVATED TO PRELIMINARY STATUS. There have been no changes to the existing parts, the drawings have been modified to show a new product offering.

Other attachments:

[Marked Copy DWG PN 794617](#)

[Marked Copy DWG PN 14450222](#)

Reason for Changes:

Customer Request. MARKET REQUESTING

Estimated Dates:

Last Order Date (Obsolete Parts Only):

First Date To Ship (Changed Parts Only):

Last Ship Date (Obsolete Parts Only):

Last Date for Mixed Shipments: (Changed Parts Only):

No Mixed Shipments

The documents listed below are being modified. Related parts that are not explicitly listed on this PCN are not being modified or discontinued as per the PCN. The Last Order Date, Last Ship Date, First Date to Ship Changed Parts and last date for Mixed Shipments apply only to parts explicitly listed on this PCN.

Note: This PCN contains only document changes, these changes do not affect the form, fit or function of the parts referenced.

Customer Drawing(s) Being Modified:

Drawing Number	Related Part Number	Customer Part Number	Current Revision	New Revision
1445022	1445022-2	TYC1445022-2	D3	

REV	DATE	BY	APPD
F	23MAR2017	CX	DZ
F1	10MAY2017	CX	DZ
F2	15MAY2018	JB	DZ
F3	16SEP2018	JB	DZ
F4	REVISED PER ECO-19-...		

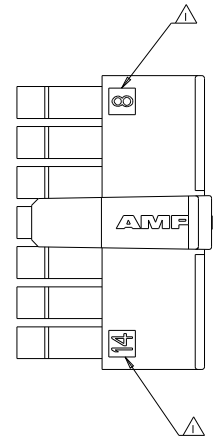

- △ CIRCUIT IDENTIFIER, LOCATED APPROXIMATELY AS SHOWN.
- △ DIMENSION ONLY 7.56 ON 2 POSITION.
- △ MATERIAL PA66/6 UL94-V0.COLOR-BLACK
- △ PRELIMINARY MATERIAL PA6, UL94-V0
- △ MATERIAL PA66 UL94-V0, GW .COLOR-NATURAL
- △ PRELIMINARY PART NOT RELEASED FOR PRODUCTION.
- △ MATERIAL ID ">PA<" LOCATED IN APPROX AREA SHOWN, APPROX 0.01 HIGH.

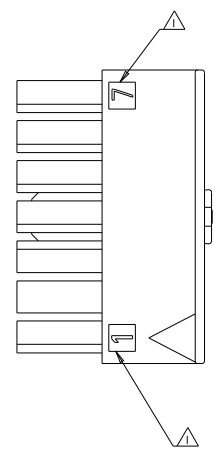
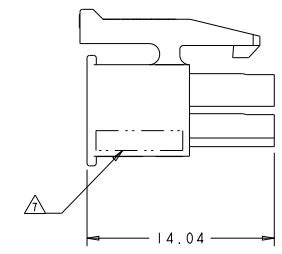
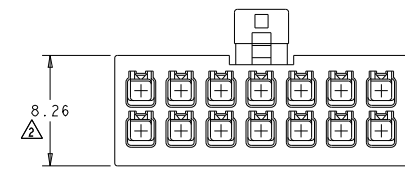
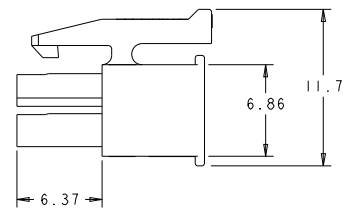
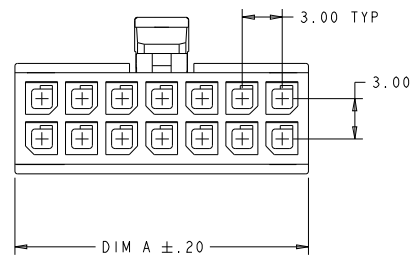

PNS TO BE REACTIVED.

MARKED COPY
SEP, 23RD, 2019
BY Washington

REMARK	DIM A	NO. OF POS.	PART NUMBER
△	31.00	20	5-794617-0
△	37.00	24	5-794617-4
△	25.00	16	4-794617-6
△	22.00	14	4-794617-4
△	19.00	12	4-794617-2
UL-V0 △	16.00	10	3-794617-0
GWPT 750°C NO FLAME	13.00	8	3-794617-8
GWFI 850°C NO FLAME	10	6	3-794617-6
△ △	7	4	3-794617-4
△ △	4	2	3-794617-2
△ △	13.00	8	2-794617-8
△	37.00	24	2-794617-4
△	34.00	22	2-794617-2
△	31.00	20	2-794617-0
△	28.00	18	1-794617-8
△	25.00	16	1-794617-6
△	22.00	14	1-794617-4
△	19.00	12	1-794617-2
△	16.00	10	1-794617-0
△	13.00	8	794617-8
△	10.00	6	794617-6
△	7.00	4	794617-4
△ △	4.00	2	794617-2

THIS DRAWING IS A CONTROLLED DOCUMENT.

DRN	140C11999
CHK	140C11999
APPD	140C11999

TE Connectivity

RECEPTACLE HOUSING, 2 TO 24 POSITION, DUAL ROW, MICRO MATE-N-LOK™

DATE: 00779
SCALE: 5:1

REV	DATE	BY	APPD
D	17MAR2011	CX	DZ
D1	15MAY2018	JB	DZ
D2	16SEP2018	JB	DZ
D3	26SEP2018	JB	DZ
D4	REVISD PER ECO-19-...		

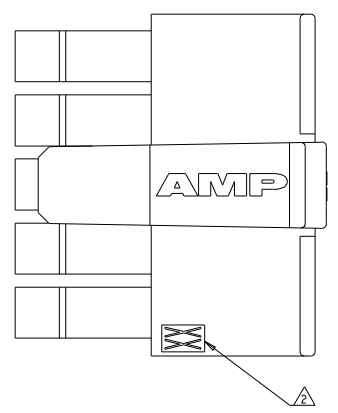

- △ CIRCUIT 1 IDENTIFIER, LOCATED APPROXIMATELY AS SHOWN.
- △ LAST CIRCUIT IDENTIFIER, LOCATED APPROXIMATELY AS SHOWN.
- △ MATERIAL PA66/6 UL94-V0. COLOR - BLACK
- △ PRELIMINARY MATERIAL PA66 UL94-V0 GW. COLOR - NATURAL
- △ MATERIAL ID ">PA<" LOCATED IN APPROX AREA SHOWN, APPROX 0.01 HIGH.
- △ PRELIMINARY PART NUMBER NOT RELEASED FOR PRODUCTION

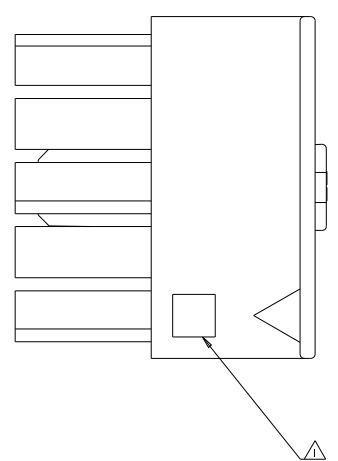
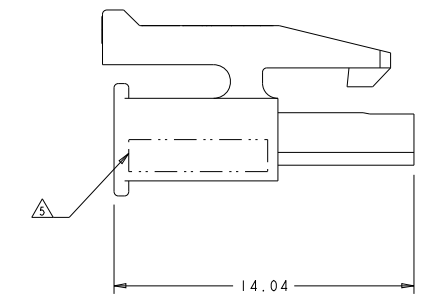
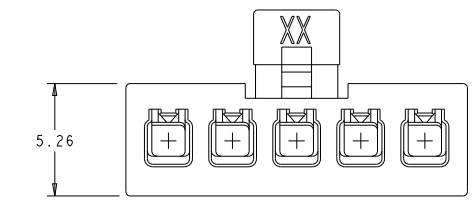
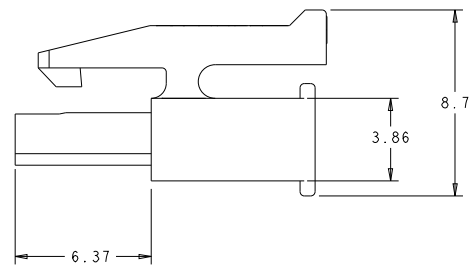
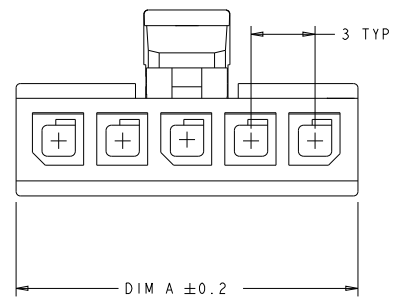

MARKED COPY
 SEP, 23RD, 2019
 BY Washington

△ 19	△ 6	△ 2-1445022-6
△ 16	△ 5	△ 2-1445022-5
△ 13	△ 4	△ 2-1445022-4
△ 10	△ 3	△ 2-1445022-3
△ 7	△ 2	△ 2-1445022-2
△ 37	△ 12	△ 1-1445022-2
△ 34	△ 11	△ 1-1445022-1
△ 31	△ 10	△ 1-1445022-0
△ 28	△ 9	△ 1445022-9
△ 25	△ 8	△ 1445022-8
△ 22	△ 7	△ 1445022-7
△ 19	△ 6	△ 1445022-6
△ 16	△ 5	△ 1445022-5
△ 13	△ 4	△ 1445022-4
△ 10	△ 3	△ 1445022-3
△ 7	△ 2	△ 1445022-2
REMARK		

DIM A	NO OF POS.	PART NO.
19	6	2-1445022-6
16	5	2-1445022-5
13	4	2-1445022-4
10	3	2-1445022-3
7	2	2-1445022-2
37	12	1-1445022-2
34	11	1-1445022-1
31	10	1-1445022-0
28	9	1445022-9
25	8	1445022-8
22	7	1445022-7
19	6	1445022-6
16	5	1445022-5
13	4	1445022-4
10	3	1445022-3
7	2	1445022-2

THIS DRAWING IS A CONTROLLED DOCUMENT.

DRAWN: WILLIAMS	DATE: 14AUG2001
CHEK: JONES	DATE: 14AUG2001
APP: JONES	DATE: 14AUG2001

TE Connectivity
 RECEPTACLE HOUSING,
 2 TO 12 POSITION, SINGLE ROW,
 MICRO MATE-L-LOK(TM)

SCALE: 8:1 SHEET: 1 OF 1 REV: D4