

## FO converters - FL MC EF WDM-SET SC - 2902660

Please be informed that the data shown in this PDF Document is generated from our Online Catalog. Please find the complete data in the user's documentation. Our General Terms of Use for Downloads are valid (<http://phoenixcontact.com/download>)



FO converter set, consisting of type A devices and type B devices, for full duplex transmission from 10/100Base-T(X) to individual simplex fiberglass with WDM (wavelength division multiplex) technology. SC simplex fiber optic connection (1550/1310 nm).

### Product Description

Optical transmission with FO technology provides superior immunity to interference at maximum transmission ranges without restricting the transmission bandwidth.

### Your advantages

- ✓ Device set for operation on one fiber
- ✓ Full duplex communication with only one fiber
- ✓ Transmission ranges up to 38 km
- ✓ Auto negotiation
- ✓ Auto MDI/MDI-X switch-over
- ✓ Link fault pass through (LFPT) and far end fault (FEF) functions for easy connection monitoring
- ✓ Data rates 10/100 Mbps
- ✓ Shipbuilding approval in accordance with DNV GL



### Key Commercial Data

Packing unit	1 pc
GTIN	
GTIN	4046356670616
Weight per Piece (excluding packing)	434.200 g
Custom tariff number	85176200
Country of origin	Germany

### Technical data

#### Dimensions

Caption	Slim design
---------	-------------

#### Ambient conditions

# FO converters - FL MC EF WDM-SET SC - 2902660

## Technical data

### Ambient conditions

Altitude	≤ 5000 m (For restrictions, see the manufacturer's declaration for altitude operation)
	≤ 2000 m (With UL approval)

### General

Net weight	434.2 g
------------	---------

### Interfaces

Transmission medium	Copper
---------------------	--------

### Optical interface FO

Wavelength	1550 nm
	1310 nm
Transmission length incl. 3 dB system reserve	38 km (With F-E 9/125 0.36 dB/km)
	34 km (With F-E 9/125 0.4 dB/km)
	28 km (With F-E 9/125 0.5 dB/km)
	21 km (with F-G 62,5/125 0,7 dB/km F 1000)
	5.5 km (with F-G 62.5/125 2.6 dB/km F 600)
	21 km (with F-G 50/125 0,7 dB/km F 1200)
	9 km (with F-G 50/125 1,6 dB/km F 800)
Transmission medium	Multi-mode fiberglass
	Single-mode fiberglass
Connection method	SC simplex

### Conformance/approvals

Designation	EAC
Identification	EAC
Designation	Corrosive gas test
Identification	ISA-S71.04-1985 G3 Harsh Group A
Designation	Shipbuilding
Identification	DNV GL
Temperature	B
Humidity	A
Vibration	A
EMC	B
Enclosure	Required protection according to the Rules shall be provided upon installation on board

### Environmental Product Compliance

REACH SVHC	Lead 7439-92-1
China RoHS	Environmentally Friendly Use Period = 50
	For details about hazardous substances go to tab "Downloads", Category "Manufacturer's declaration"

# FO converters - FL MC EF WDM-SET SC - 2902660

## Drawings

Schematic diagram

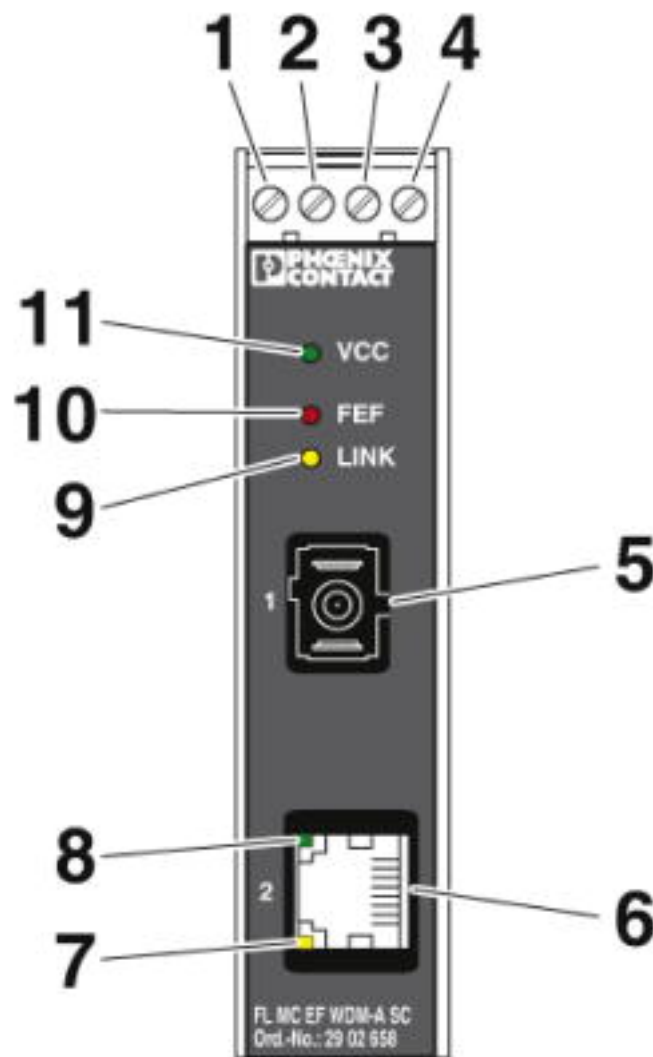

Front view

# FO converters - FL MC EF WDM-SET SC - 2902660

Application drawing

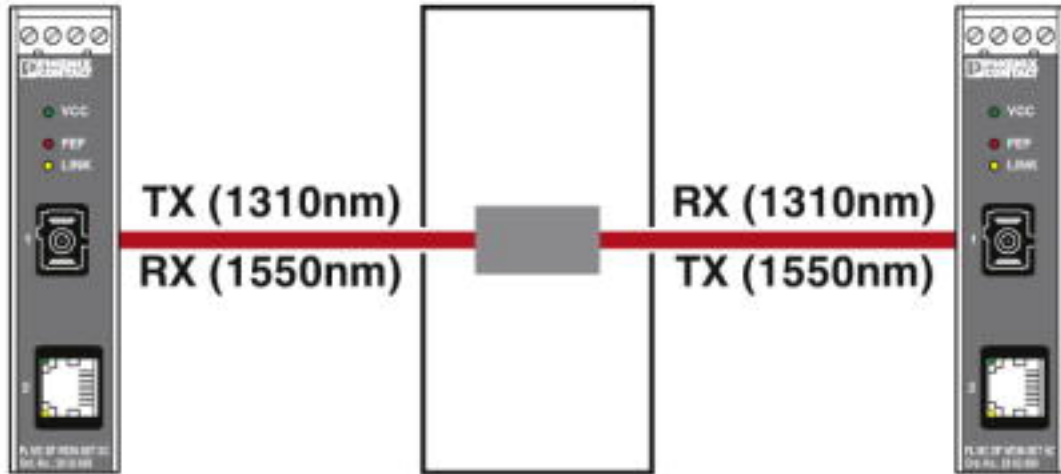

Slip ring communication

Dimensional drawing

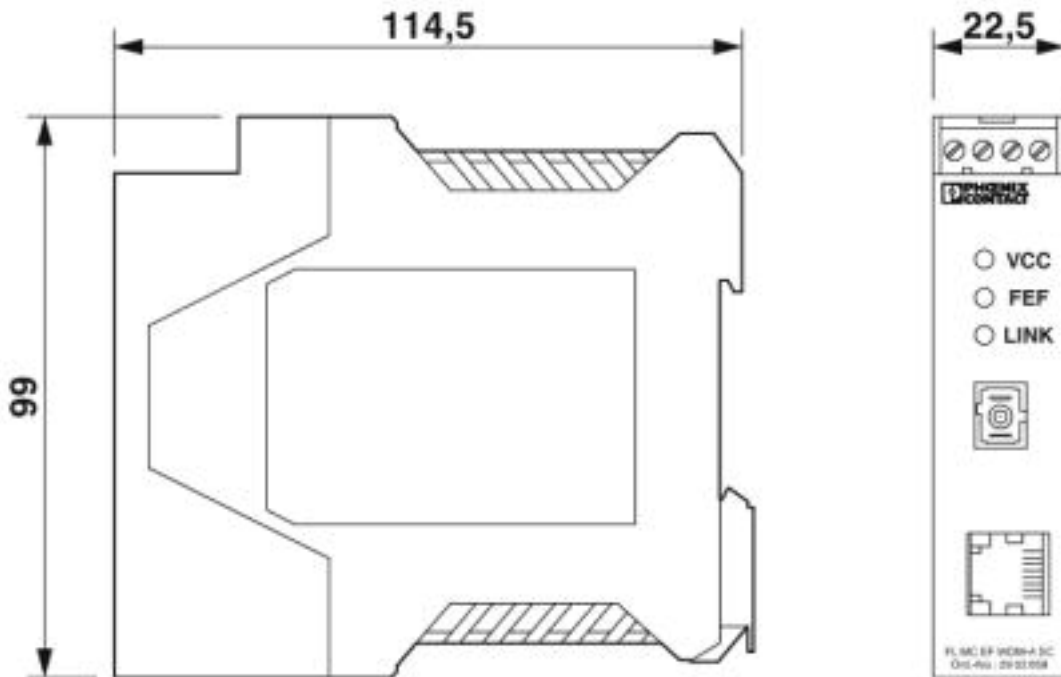

Slim design

## FO converters - FL MC EF WDM-SET SC - 2902660

Schematic diagram

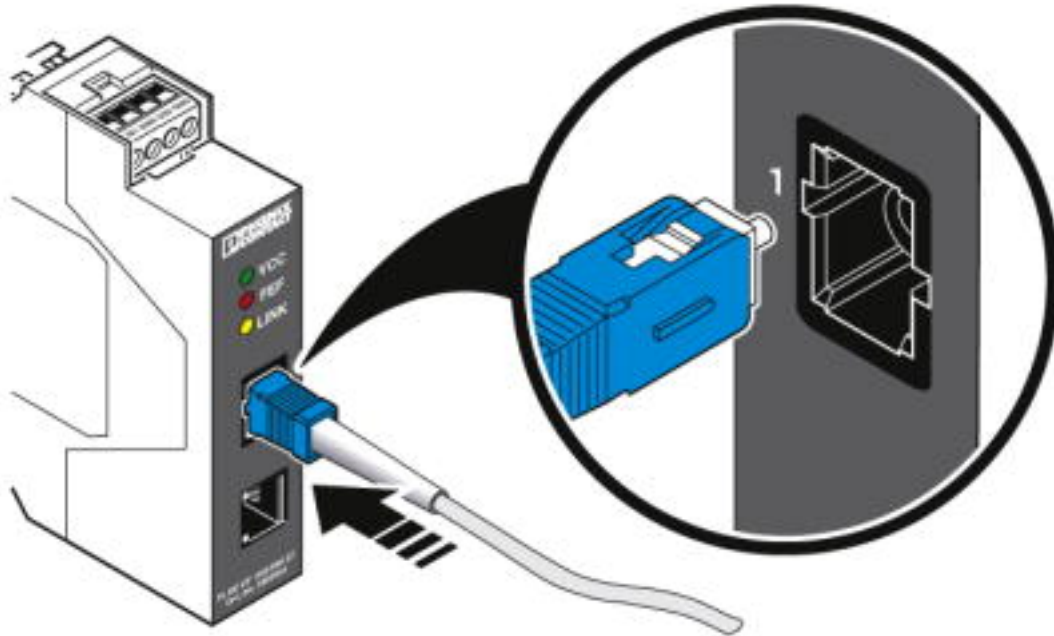

Connect SC simplex plug

# FO converters - FL MC EF WDM-SET SC - 2902660

Schematic diagram

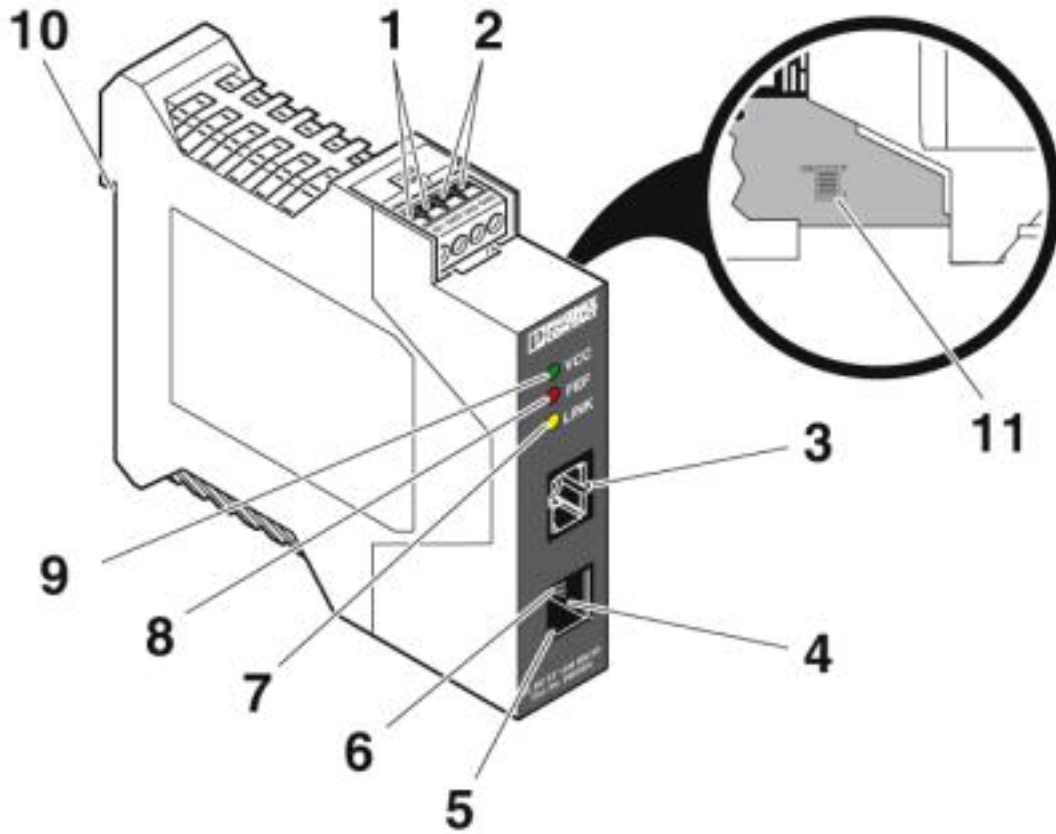

Function elements

# FO converters - FL MC EF WDM-SET SC - 2902660

Schematic diagram

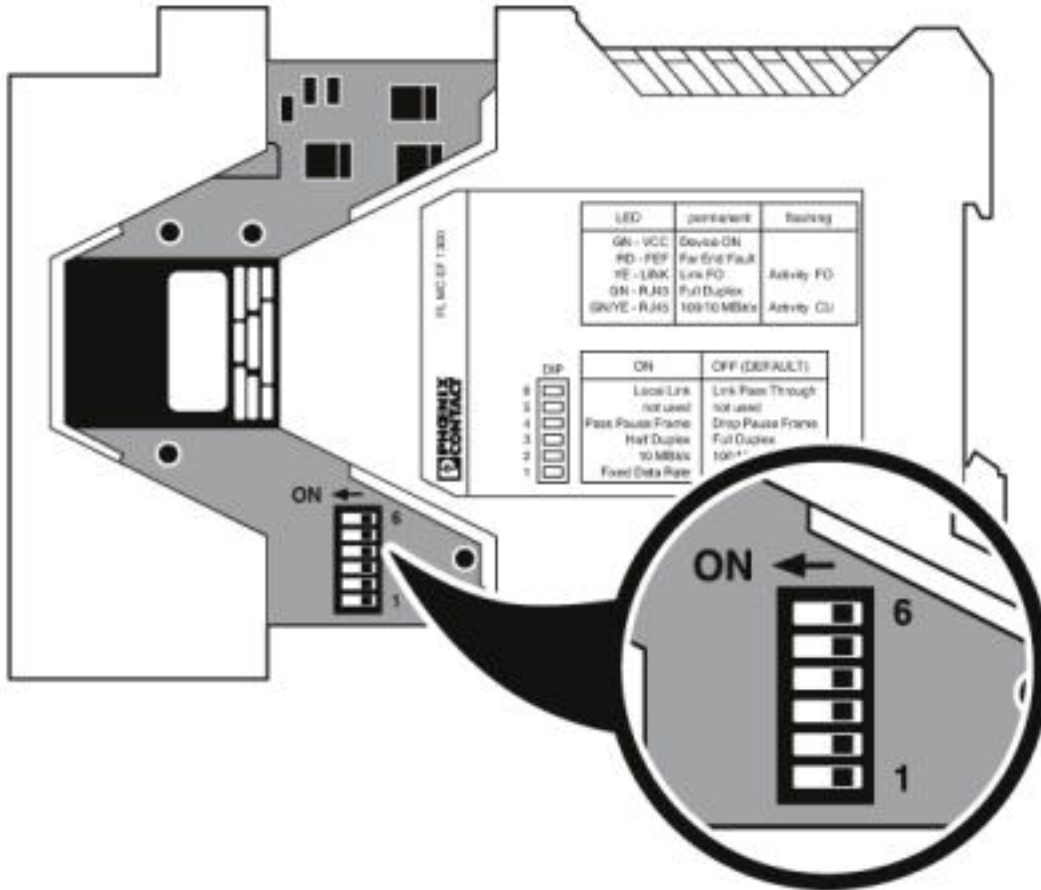

DIP switches

# FO converters - FL MC EF WDM-SET SC - 2902660

Block diagram

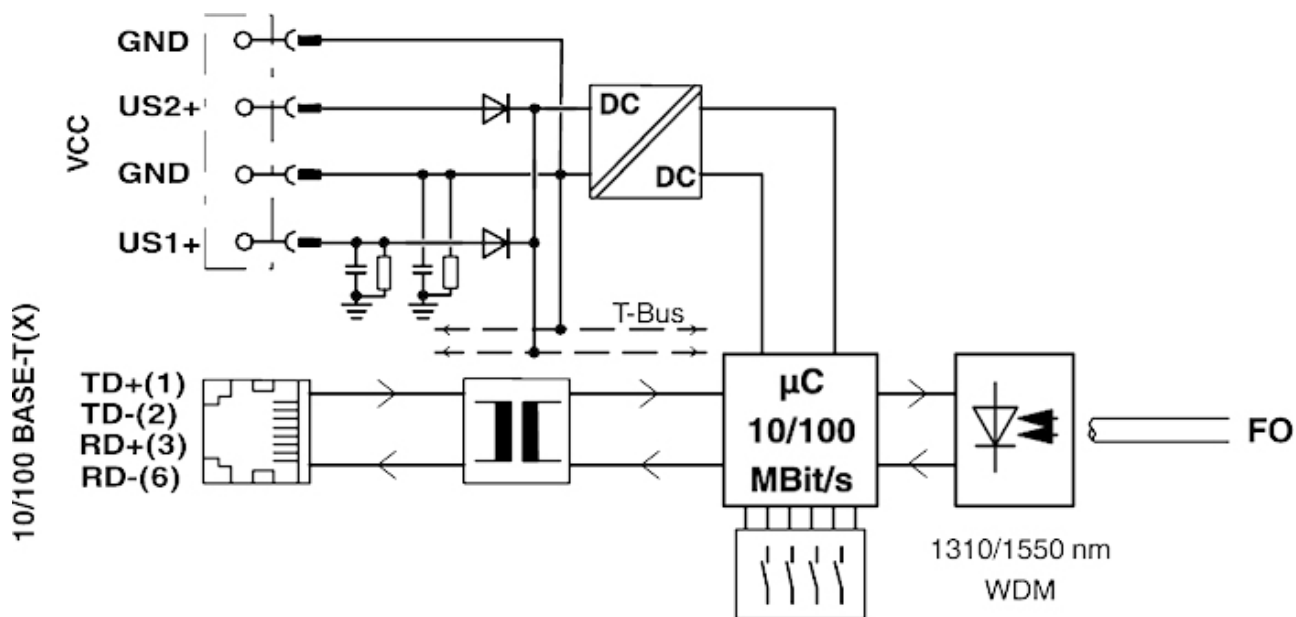



# FO converters - FL MC EF WDM-SET SC - 2902660

Application drawing

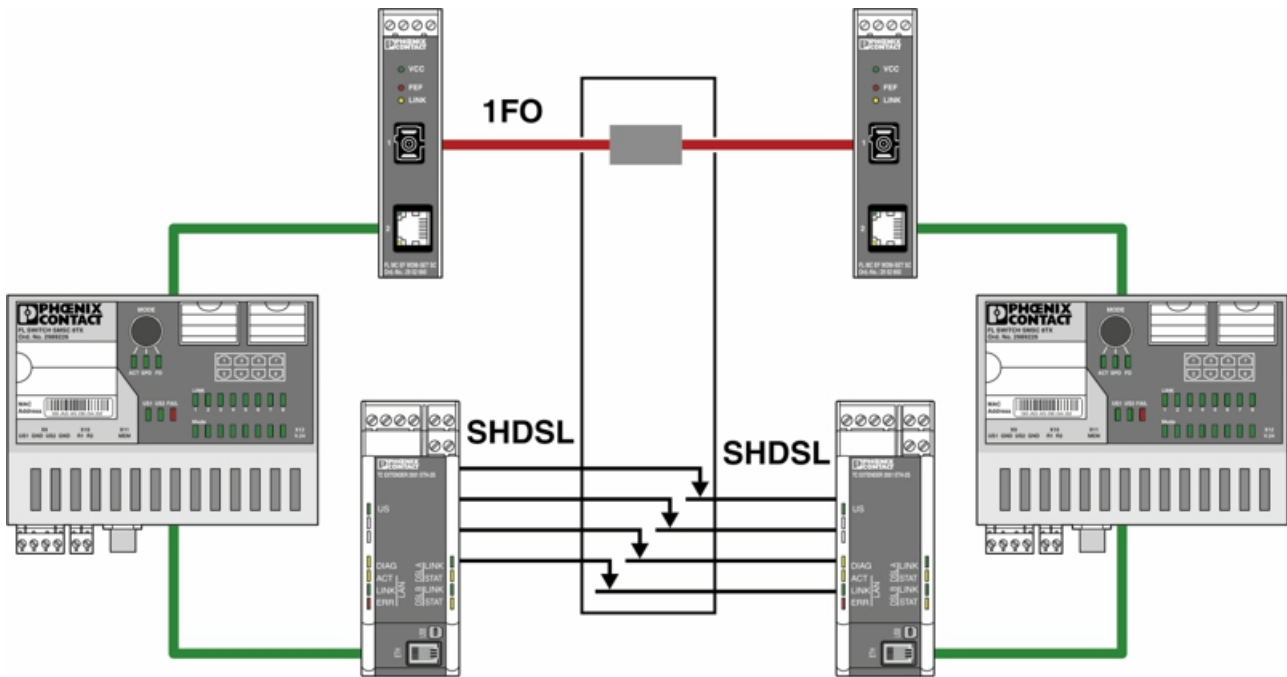

Redundant slip ring communication

## Articles in set

FO converters - FL MC EF WDM-A SC - 2902658



FO converter (replacement device A), for full duplex transmission from 10/100Base-T(X) to individual simplex fiberglass with WDM (wavelength division multiplex) technology, SC simplex fiber optic connection (1310/1550 nm). Device set (type A and type B) required for operation.

## FO converters - FL MC EF WDM-SET SC - 2902660

### Articles in set

FO converters - FL MC EF WDM-B SC - 2902659



FO converter (replacement device B), for full duplex transmission from 10/100Base-T(X) to individual simplex fiberglass with WDM (wavelength division multiplex) technology, SC simplex fiber optic connection (1550/1310 nm). Device set (type A and type B) required for operation.

### Classifications

#### eCl@ss

eCl@ss 4.0	27230200
eCl@ss 4.1	27230200
eCl@ss 5.0	27230200
eCl@ss 5.1	27230200
eCl@ss 6.0	27230200
eCl@ss 7.0	19170114
eCl@ss 8.0	19170114
eCl@ss 9.0	19170114

#### ETIM

ETIM 3.0	EC000310
ETIM 4.0	EC000310
ETIM 5.0	EC001467
ETIM 6.0	EC001467
ETIM 7.0	EC001467

#### UNSPSC

UNSPSC 6.01	30211506
UNSPSC 7.0901	39121008
UNSPSC 11	39121008
UNSPSC 12.01	39121008
UNSPSC 13.2	39121008
UNSPSC 18.0	43223323
UNSPSC 19.0	43223323
UNSPSC 20.0	43223323
UNSPSC 21.0	43223323

### Approvals

#### Approvals

## FO converters - FL MC EF WDM-SET SC - 2902660

### Approvals

Approvals



DNV GL / EAC

---

Ex Approvals

---

### Approval details

DNV GL		<a href="https://approvalfinder.dnvgl.com/">https://approvalfinder.dnvgl.com/</a>	TAA00001KR
EAC			RU*DE*08.B.00731/19

### Accessories

Accessories

Data cable by the meter

Network cable - FL CAT5 HEAVY - 2744814



CAT5-SF/UTP cable (J-02YS(ST)C HP 2 x 2 x 24 AWG), heavy-duty installation cable, 2 x 2 x 0.22 mm<sup>2</sup>, solid conductor, shielded, outer sheath: 7.8 mm diameter, inner sheath: 5.75 mm ± 0.15 mm diameter

---

Network cable - FL CAT5 FLEX - 2744830



CAT5-SF/UTP cable (J-LI02YS(ST)C H 2 x 2 x 26 AWG), light-duty, flexible installation cable 2 x 2 x 0.14 mm<sup>2</sup>, stranded, shielded, outer sheath: 5.75 mm ± 0.15 mm diameter

---

FO cable - PSM-LWL-GDO- 50/125 - 2799432



Fiberglass cable, duplex 50/125 µm, by the meter, without connector, for outdoor installation

---

## FO converters - FL MC EF WDM-SET SC - 2902660

### Accessories

FO cable - PSM-LWL-GDM-RUGGED- 50/125 - 2799322



Fiber glass cable, duplex 50 µm/125 µm, by the meter, without male connector, for installation in stationary systems and machines

---

### Data cable preassembled

Fiber optic cable - FOC-LC:PA-SC:PA-OM2:D01/1 - 1115607



---

Fiber optic cable - FOC-LC:PA-SC:PA-OM2:D01/2 - 1115605



---

Fiber optic cable - FOC-SC:PA-SC:PA-OM2:D01/1 - 1115536



Multi-mode OM2 duplex jumper, SC-SC, UPC polishing, length 1 m

---

Fiber optic cable - FOC-SC:PA-SC:PA-OM2:D01/2 - 1115535



Multi-mode OM2 duplex jumper, SC-SC, UPC polishing, length 2 m

## FO converters - FL MC EF WDM-SET SC - 2902660

### Accessories

Fiber optic cable - FOC-ST:PA-SC:PA-OM2:D01/1 - 1115574



Multi-mode OM2 duplex jumper, ST-SC, UPC polishing, length 1 m

---

Fiber optic cable - FOC-ST:PA-SC:PA-OM2:D01/2 - 1115573



Multi-mode OM2 duplex jumper, ST-SC, UPC polishing, length 2 m

---

Fiber optic cable - FOC-LC:PA-SC:PA-OM4:D01/1 - 1115601



Multi-mode OM4 duplex jumper, LC-SC, UPC polishing, length 1 m

---

Fiber optic cable - FOC-LC:PA-SC:PA-OM4:D01/2 - 1115600



Multi-mode OM4 duplex jumper, LC-SC, UPC polishing, length 2 m

---

Fiber optic cable - FOC-SC:PA-SC:PA-OM4:D01/1 - 1115424



Multi-mode OM4 duplex jumper, SC-SC, UPC polishing, length 1 m

---

## FO converters - FL MC EF WDM-SET SC - 2902660

### Accessories

Fiber optic cable - FOC-SC:PA-SC:PA-OM4:D01/2 - 1115423



Multi-mode OM4 duplex jumper, SC-SC, UPC polishing, length 2 m

---

FO patch cable - FOC-GDM-RUGGED-1016/IP20/... - 2901558



Robust GOF installation cable for assembly (IP20 heads only) for installation in stationary systems and machines, aramid strain-relief elements, with individual elements made from FRNC material, halogen-free, ozone and UV resistant, with a polyurethane (PUR) outer sheath

---

FO patch cable - FOC-GDM-RUGGED-1016/... - 1402193



rugged GOF installation cable for inner areas with highly tear-proof aramid strain-relief elements. Individual elements consist of highly flexible FRNC material. The cable is halogen-free, ozone and UV resistant and has a rugged polyurethane (PUR) outer sheath.

---

FO patch cable - FOC-GDO-1017/IP20/... - 2901559



Highly rugged GOF round cable (IP20 heads only) for assembly and for outdoor installation with integrated moisture barrier as well as rodent-proof scrim. Individual elements made from highly flexible FRNC material. The wire is ozone and UV resistant with a very rugged polyethylene outer sheath.

---

Fiber optic cable - FOC-SC:PA-SC:PA-OS2:D01/1 - 1115550



Single-mode OS2 duplex jumper, SC-SC, UPC polishing, length 1 m

---

## FO converters - FL MC EF WDM-SET SC - 2902660

### Accessories

Fiber optic cable - FOC-SC:PA-SC:PA-OS2:D01/2 - 1115548



Single-mode OS2 duplex jumper, SC-SC, UPC polishing, length 2 m

---

Fiber optic cable - FOC-ST:PA-SC:PA-OS2:D01/1 - 1115582



Single-mode OS2 duplex jumper, ST-SC, UPC polishing, length 1 m

---

Fiber optic cable - FOC-ST:PA-SC:PA-OS2:D01/2 - 1115581



Single-mode OS2 duplex jumper, ST-SC, UPC polishing, length 2 m

---

Fiber optic cable - FOC-LC:PA-SC:PA-OS2:D01/1 - 1115618



Single-mode OS2 duplex jumper, LC-SC, UPC polishing, length 1 m

---

Fiber optic cable - FOC-LC:PA-SC:PA-OS2:D01/2 - 1115617



Single-mode OS2 duplex jumper, LC-SC, UPC polishing, length 2 m

---

## FO converters - FL MC EF WDM-SET SC - 2902660

### Accessories

#### FO patch cable - FL MM PATCH 1,0 SC-SCRJ - 2901812



Assembled FO cable, break out cable, multimode fiberglass 50/125  $\mu\text{m}$  (OM2), connector: SC duplex/SC-RJ, degree of protection: IP20, for installation in cable ducts or control cabinets, length: 1 m

#### FO patch cable - FL MM PATCH 2,0 SC-SCRJ - 2901813



Assembled FO cable, break out cable, multimode fiberglass 50/125  $\mu\text{m}$  (OM2), connector: SC duplex/SC-RJ, degree of protection: IP20, for installation in cable ducts or control cabinets, length: 2 m

#### FO patch cable - FL MM PATCH 5,0 SC-SCRJ - 2901814



Assembled FO cable, break out cable, multimode fiberglass 50/125  $\mu\text{m}$  (OM2), connector: SC duplex/SC-RJ, degree of protection: IP20, for installation in cable ducts or control cabinets, length: 5 m

### Data plug

#### RJ45 connector - VS-08-RJ45-5-Q/IP20 - 1656725



RJ45 connector, degree of protection: IP20, number of positions: 8, 1 Gbps, CAT5 (IEC 11801:2002), material: PA, connection method: IDC fast connection, connection cross section: AWG 26- 23, cable outlet: straight, color: traffic grey A RAL 7042

#### RJ45 connector - VS-08-RJ45-5-Q/IP20 BK - 1658008



RJ45 connector, degree of protection: IP20, number of positions: 8, 1 Gbps, CAT5 (IEC 11801:2002), material: PA, connection method: IDC fast connection, connection cross section: AWG 26- 23, cable outlet: straight, color: black

### DIN rail connector



## FO converters - FL MC EF WDM-SET SC - 2902660

### Accessories

DIN rail bus connectors - ME 22,5 TBUS 1,5/ 5-ST-3,81 GN - 2707437



DIN rail connector, number of positions: 5, pitch: 3.81 mm, pin layout: Linear pinning, Articles with gold-plated contacts, bus connectors for connecting with electronic housings

DIN rail bus connectors - ME 17,5 TBUS 1,5/ 5-ST-3,81 GN - 2709561



DIN rail connector for DIN rail mounting. Universal for TBUS housing. Gold-plated contacts, 5-pos.

### Media converter

FO converters - FL MC EF WDM-A SC - 2902658



FO converter (replacement device A), for full duplex transmission from 10/100Base-T(X) to individual simplex fiberglass with WDM (wavelength division multiplex) technology, SC simplex fiber optic connection (1310/1550 nm). Device set (type A and type B) required for operation.

FO converters - FL MC EF WDM-B SC - 2902659



FO converter (replacement device B), for full duplex transmission from 10/100Base-T(X) to individual simplex fiberglass with WDM (wavelength division multiplex) technology, SC simplex fiber optic connection (1550/1310 nm). Device set (type A and type B) required for operation.

### Patch cable

Patch cable - FL CAT5 PATCH 0,5 - 2832263



Patch cable, CAT5, assembled, 0.5 m

## FO converters - FL MC EF WDM-SET SC - 2902660

### Accessories

Patch cable - FL CAT5 PATCH 1,0 - 2832276



Patch cable, CAT5, assembled, 1 m

---

Patch cable - FL CAT5 PATCH 2,0 - 2832289



Patch cable, CAT5, assembled, 2 m

---

Patch cable - FL CAT5 PATCH 3,0 - 2832292



Patch cable, CAT5, assembled, 3 m

---

### Power supply

Power supply unit - MINI-SYS-PS-100-240AC/24DC/1.5 - 2866983



Primary-switched MINI POWER supply for DIN rail mounting, input: 1-phase, output: 24 V DC/1.5 A

---

Assembly tool - FL CRIMPTOOL - 2744869



Crimping pliers, for assembling the RJ45 plugs FL PLUG RJ45..., for assembly on site

---