

Base module - VIP/S/MC/BASE 9-16/L/C/EX - 2907187

Please be informed that the data shown in this PDF Document is generated from our Online Catalog. Please find the complete data in the user's documentation. Our General Terms of Use for Downloads are valid (<http://phoenixcontact.com/download>)



VIP base module with input/output accessories (IOA) provide universal channel configuration. This module has markings for channels 9-16 and includes conformal coating of the printed circuit board assembly.

Your advantages

- Integrated carrier for IOA insertion and retention
- Screw-clamp field connections
- Conformal coating of PCB
- Two isolated power bus options
- Channels for marking accessories
- Integrated DIN rail ground foot
- Rugged metal DIN rail foot for ease of installation or removal from the rail



Key Commercial Data

Packing unit	1 pc
GTIN	 4 055626 239507
GTIN	4055626239507
Weight per Piece (excluding packing)	450.000 g
Custom tariff number	85366990
Country of origin	United States
Note	Made to Order (non-returnable)

Technical data

Dimensions

Width	118.1 mm
Height	102.7 mm
Depth	72.2 mm

Ambient conditions

Ambient temperature (operation)	-40 °C ... 75 °C
---------------------------------	------------------

Base module - VIP/S/MC/BASE 9-16/L/C/EX - 2907187

Technical data

Ambient conditions

Ambient temperature (storage/transport)	-40 °C ... 75 °C
Permissible humidity (operation)	0 % ... 95 % (non-condensing)
Degree of protection	IP20

General

Max. operating voltage U_{max}	30 V DC (P2 and field terminals)
Max. operating voltage	30 V DC (P2 and field terminals)
	230 V AC (P2 and field terminals)
	30 V DC (P1 terminals)
	30 V (X30 and X31 connectors)
Max. perm. current (per branch)	3 A (field signal)
	1 A (control contacts)
Max. permissible current	15 A ()
Max. permissible total current	15 A (per module)
Status display	No
Mounting position	As desired on 35 mm DIN rail in acc. with EN 60715

Safety data

Input voltage U_i	30 V (per channel)
Input current I_i	1 A (per channel)
Inductance L_i	0 mH
Capacitance C_i	0 μ F
ATEX	Sira 16ATEX4260X; Ex II 3G Ex nA ic IIC T4 Gc; Ex nA IIC T4 Gc
IECEX	IECEX SIR 16.0088X Ex nA ic IIC T4 Gc; Ex nA IIC T4 Gc
FM approval	Class I, Zone 2, AEx nA ic IIC T4 Gc; AEx nA IIC T4 Gc Nonincendive: Class I, Div. 2, Groups A, B, C, D T4 With connection to Class I, II, and III, Div. 2, Groups A, B, C, D, E, F, G

Connection data

Connection name	Field level
Connection in acc. with standard	IEC / EN
Connection method	Screw connection
Stripping length	8 mm
Screw thread	M 3
Conductor cross section solid	0.2 mm ² ... 4 mm ²
Conductor cross section flexible	0.2 mm ² ... 2.5 mm ²
Conductor cross section AWG	24 ... 12
Torque	0.5 Nm ... 0.6 Nm

Connection data 2

Connection name	Controller level
Connection method	Pluggable screw connection

Base module - VIP/S/MC/BASE 9-16/L/C/EX - 2907187

Technical data

Connection data 2

Number of connections	2
Number of positions	9

Supported controller

Controller	universal
------------	-----------

Standards and Regulations

Standards/regulations	IEC 60664
	DIN EN 50178
Conformance	ANSI/ISA 60079-0; 60079-11; 60079-15
	ANSI/IEC 60529
	FM 3600; 3611; 3810
ATEX	Sira 16ATEX4260X; Ex II 3G Ex nA ic IIC T4 Gc; Ex nA IIC T4 Gc
IECEX	IECEX SIR 16.0088X Ex nA ic IIC T4 Gc; Ex nA IIC T4 Gc

Environmental Product Compliance

REACH SVHC	Lead 7439-92-1
China RoHS	Environmentally Friendly Use Period = 50
	For details about hazardous substances go to tab "Downloads", Category "Manufacturer's declaration"

Drawings

Base module - VIP/S/MC/BASE 9-16/L/C/EX - 2907187

Dimensional drawing

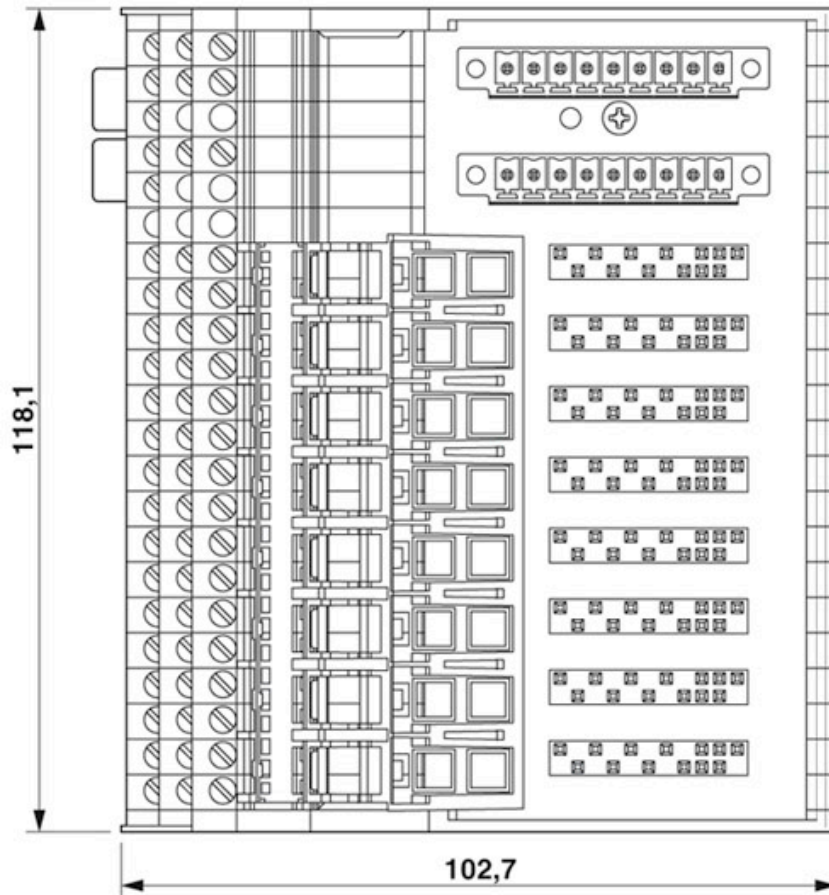
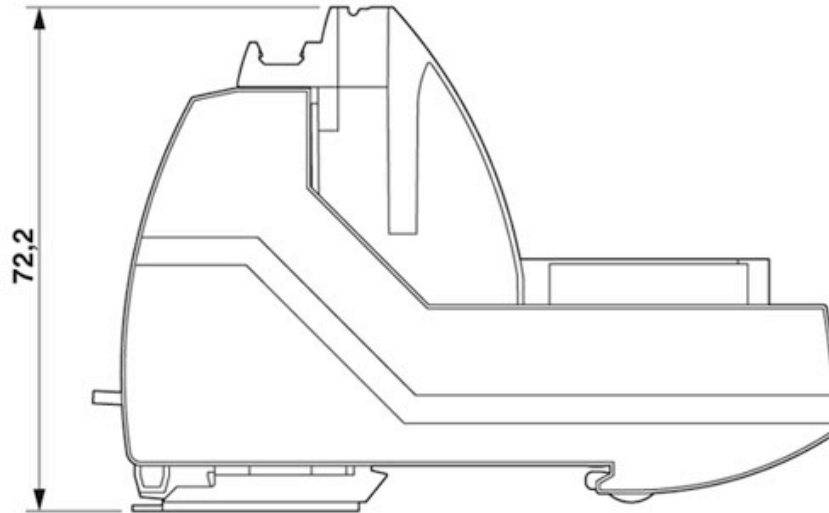

Base module - VIP/S/MC/BASE 9-16/L/C/EX - 2907187

Circuit diagram

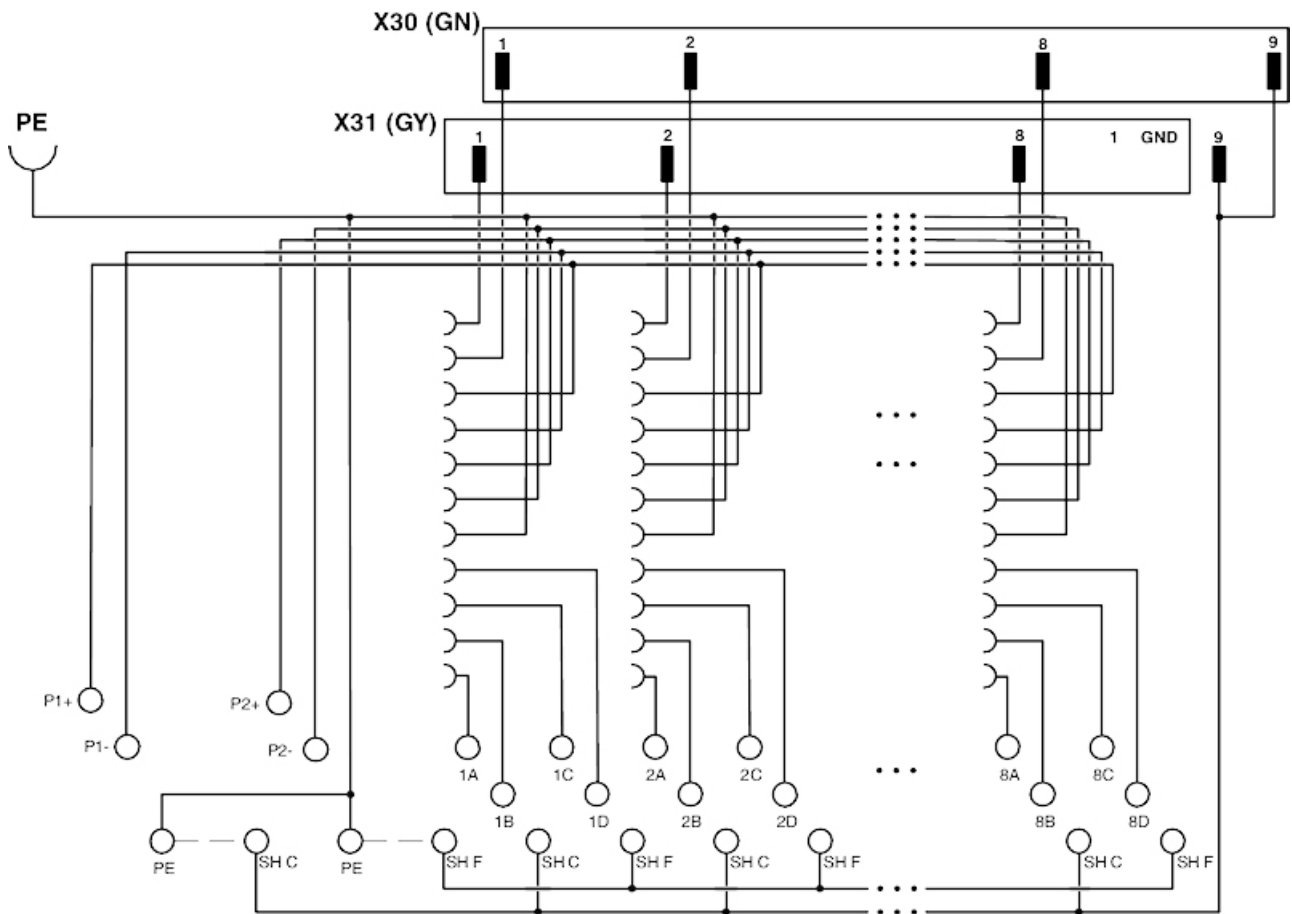

Base module - VIP/S/MC/BASE 9-16/L/C/EX - 2907187

Classifications

eCl@ss

eCl@ss 4.0	27250313
eCl@ss 4.1	27250313
eCl@ss 5.0	27250313
eCl@ss 5.1	27250313
eCl@ss 7.0	27141152
eCl@ss 8.0	27141152
eCl@ss 9.0	27141152

ETIM

ETIM 4.0	EC002780
ETIM 5.0	EC002780
ETIM 6.0	EC002780
ETIM 7.0	EC002780

UNSPSC

UNSPSC 13.2	39121432
UNSPSC 18.0	39121432
UNSPSC 19.0	39121432
UNSPSC 20.0	39121432
UNSPSC 21.0	39121432

Approvals

Approvals

Approvals

Functional Safety

Ex Approvals

IECEX / ATEX / FM approved / CSA / CSAus / cCSAus

Approval details

Functional Safety	PHO 1609035 C001
-------------------	------------------

Accessories

Accessories

Forcibly guided coupling relay

Base module - VIP/S/MC/BASE 9-16/L/C/EX - 2907187

Accessories

Coupling relay - IOA-PSR-PS22-1NO-1NC-24DC - 2702971



Pluggable SIL coupling relay as an input/output accessory for VIP base module, SIL 3 high and low-demand applications, safe-state-off, couples digital output signals to the periphery, 1 enabling current path, 1 confirmation current path, test pulse filter

Marker pen

Marker pen - B-STIFT - 1051993



Marker pen, for manual labeling of unprinted Zack strips, smear-proof and waterproof, line thickness 0.5 mm

Partition plate

Partition plate - VIP/S/BASE 3L DIVIDER - 2907715



Safety divider provides physical separation between field terminals and power bus terminals on VIP base module

Partition plate - VIP/U/RAIL 3L DIVIDER - 2908555



Divider provides physical separation between field terminals and power bus terminals on VIP base module. This version mounts directly to the DIN rail at the end of the base module when separation between circuits is required.

PCB plug

Printed-circuit board connector - VIP/S/MC/KIT 1-8 - 2907031



Pair of screw-clamp plugs to connect to VIP base module labeled 1-8.

Base module - VIP/S/MC/BASE 9-16/L/C/EX - 2907187

Accessories

Printed-circuit board connector - VIP/S/MC/KIT 9-16 - 2907267

Pair of screw-clamp plugs to connect to VIP base module labeled 9-16.



Printed-circuit board connector - VIP/S/MC/KIT 17-24 - 2907268

Pair of screw-clamp plugs to connect to VIP base module labeled 17-24.



Printed-circuit board connector - VIP/S/MC/KIT 25-32 - 2907269

Pair of screw-clamp plugs to connect to VIP base module labeled 25-32.



Printed-circuit board connector - VIP/S/FRONT-MC/KIT 1-8 - 2907032

Pair of screw-clamp plugs to connect to VIP base module labeled 1-8



Printed-circuit board connector - VIP/S/FRONT-MC/KIT 9-16 - 2907270

Pair of screw-clamp plugs to connect to VIP base module labeled 9-16



Base module - VIP/S/MC/BASE 9-16/L/C/EX - 2907187

Accessories

Printed-circuit board connector - VIP/S/FRONT-MC/KIT 17-24 - 2907271

Pair of screw-clamp plugs to connect to VIP base module labeled 17-24



Printed-circuit board connector - VIP/S/FRONT-MC/KIT 25-32 - 2907272

Pair of screw-clamp plugs to connect to VIP base module labeled 25-32



Terminal marking

Marker for terminal blocks - UC-TM 10 - 0818069



Marker for terminal blocks, Sheet, white, unlabeled, can be labeled with: BLUEMARK ID COLOR, BLUEMARK ID, BLUEMARK CLED, PLOTMARK, CMS-P1-PLOTTER, mounting type: snap into tall marker groove, for terminal block width: 10.2 mm, lettering field size: 9.6 x 10.5 mm, Number of individual labels: 48

Marker for terminal blocks - UC-TM 10 BU - 0818441



Marker for terminal blocks, Sheet, blue, unlabeled, can be labeled with: BLUEMARK ID COLOR, BLUEMARK ID, BLUEMARK CLED, PLOTMARK, CMS-P1-PLOTTER, mounting type: snap into tall marker groove, for terminal block width: 10.2 mm, lettering field size: 9.6 x 10.5 mm, Number of individual labels: 48

Plug - IOA MCR-CJC-PT100 - 1085776



Plug for cold junction compensation for thermocouples, in combination with MACX MCR(-EX)-TC... temperature transducers

Necessary add-on products

Base module - VIP/S/MC/BASE 9-16/L/C/EX - 2907187

Accessories

Input/output module - IOA FEED-THRU/EX - 2906598



VIP field termination assemblies (FTA) with input/output accessories (IOA) provide universal channel configuration for applications seeking to evolve from a traditional fixed I/O approach. Direct feed through of field signals, 30 V, 1 A maximum.

Input/output module - IOA AI/AO/BFI/DS/0.5A/EX - 2906599



VIP field termination assemblies (FTA) with input/output accessories (IOA) provide universal channel configuration for applications seeking to evolve from a traditional fixed I/O approach. Analog input and output signals, fused with blown fuse indication, disconnect with test points, 500 mA rating.

Input/output module - IOA DI/DO/BFI/DS/1.0A/EX - 2906600



VIP field termination assemblies (FTA) with input/output accessories (IOA) provide universal channel configuration for applications seeking to evolve from a traditional fixed I/O approach. Digital input and output signals, fused with blown fuse indication, disconnect with test points, 30 V, 1 A maximum.

Input/output module - IOA REL 24V DO/BFI/3.0A/EX - 2910153



VIP field termination assemblies (FTA) with input/output accessories (IOA) provide universal channel configuration for applications seeking to evolve from a traditional fixed I/O approach. Digital relay output, fused with blown fuse indication, selectable NO or NC contact, 24 V DC, 3 A rating.

Input/output module - IOA REL 24V DI/BFI/1.0A/EX - 2910155



VIP field termination assemblies (FTA) with input/output accessories (IOA) provide universal channel configuration for applications seeking to evolve from a traditional fixed I/O approach. Digital relay input, fused with blown fuse indication, active circuit indication, 24 V DC.

Base module - VIP/S/MC/BASE 9-16/L/C/EX - 2907187

Accessories

Input/output module - IOA REL 120V DO/BFI/3.0A/EX - 2910154



VIP field termination assemblies (FTA) with input/output accessories (IOA) provide universal channel configuration for applications seeking to evolve from a traditional fixed I/O approach. Digital relay output, fused with blown fuse indication, selectable NO or NC contact, 120 V AC, 3 A rating.

Input/output module - IOA REL 120V DI/1.0A/EX - 2910157



VIP field termination assemblies (FTA) with input/output accessories (IOA) provide universal channel configuration for applications seeking to evolve from a traditional fixed I/O approach. Digital relay input, fused with blown fuse indication, active circuit indication, 120 V AC.

Input/output module - IOA REL 230V DO/BFI/NO/3.0A/EX - 2910421



VIP field termination assemblies (FTA) with input/output accessories (IOA) provide universal channel configuration for applications seeking to evolve from a traditional fixed I/O approach. Digital relay output, fused, NO contact, 230 V AC, 3 A rating.

Input/output module - IOA REL 230V DO/BFI/NC/3.0A/EX - 2910422



VIP field termination assemblies (FTA) with input/output accessories (IOA) provide universal channel configuration for applications seeking to evolve from a traditional fixed I/O approach. Digital relay output, fused with blown fuse indication, NC contact, 230 V AC, 3 A rating.

Input/output module - IOA REL 230V DI/1.0A/EX - 2910423



VIP field termination assemblies (FTA) with input/output accessories (IOA) provide universal channel configuration for applications seeking to evolve from a traditional fixed I/O approach. Digital relay input, fused with blown fuse indication, active circuit indication, 230 V AC.

Base module - VIP/S/MC/BASE 9-16/L/C/EX - 2907187

Accessories

Power/input isolating amplifier - IOA RPSS-I-I/HART/EX - 2908452



IOA with three-way repeater power supply with plug-in technology. HART-transparent, input or output signal 0(4)...20 mA. The device can be used in both isolator and repeater power supply operation.