

# Low Dropout Regulator, Wide Input Voltage, Low Iq, 300 mA

## NCP718

The NCP718 is 300 mA LDO Linear Voltage Regulator. It is a very stable and accurate device with ultra-low quiescent current consumption (typ. 4  $\mu$ A over the full temperature range) and a wide input voltage range (up to 24 V). The regulator incorporates several protection features such as Thermal Shutdown and Current Limiting.

### Features

- Operating Input Voltage Range: 2.5 V to 24 V
- Fixed Voltage Options Available: 1.2 V to 5 V (upon request)
- Adjustable Voltage Option from 1.2 V to 5 V
- Ultra-Low Quiescent Current: typ. 4  $\mu$ A over Temperature
- $\pm 2\%$  Accuracy Over Full Load, Line and Temperature Variations
- PSRR: 60 dB at 1 kHz
- Noise: typ. 36  $\mu$ V<sub>RMS</sub> from 100 Hz to 100 kHz
- Stable with Small 1  $\mu$ F Ceramic Capacitor
- Soft-start to Reduce Inrush Current and Overshoots
- Thermal Shutdown and Current Limit Protection
- SOA Limiting for High Vin / High Iout – Static / Dynamic
- Active Discharge Option Available (upon request)
- Available in TSOT-23-5 and WDFN6 2x2 mm Packages
- These Devices are Pb-Free, Halogen Free/BFR Free and are RoHS Compliant

### Typical Applications

- Wireless Chargers
- Portable Equipment
- Communication Systems

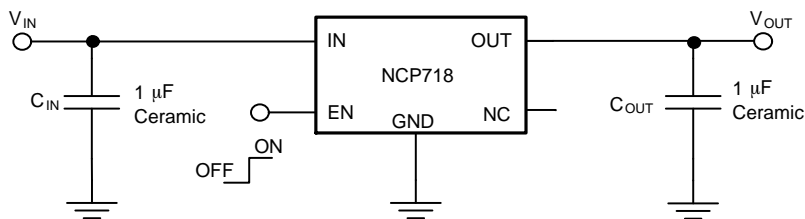

Figure 1. Typical Application Schematic



ON Semiconductor®

[www.onsemi.com](http://www.onsemi.com)

### MARKING DIAGRAMS

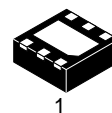

WDFN6  
MT SUFFIX  
CASE 511BR



XX = Specific Device Code  
M = Date Code



TSOT-23-5  
SN SUFFIX  
CASE 419AE

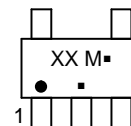

XX = Specific Device Code  
M = Date Code\*  
▪ = Pb-Free Package

(Note: Microdot may be in either location)

\*Date Code orientation and/or position may vary depending upon manufacturing location.

### PIN CONNECTIONS

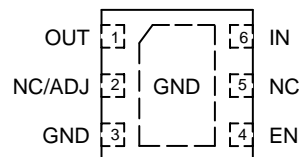

WDFN6 2x2 mm  
(Top View)

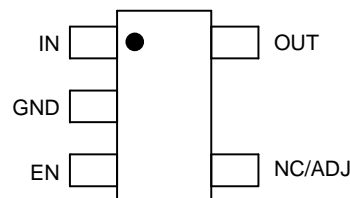

TSOT-23-5  
(Top View)

### ORDERING INFORMATION

See detailed ordering and shipping information in the package dimensions section on page 7 of this data sheet.

# NCP718

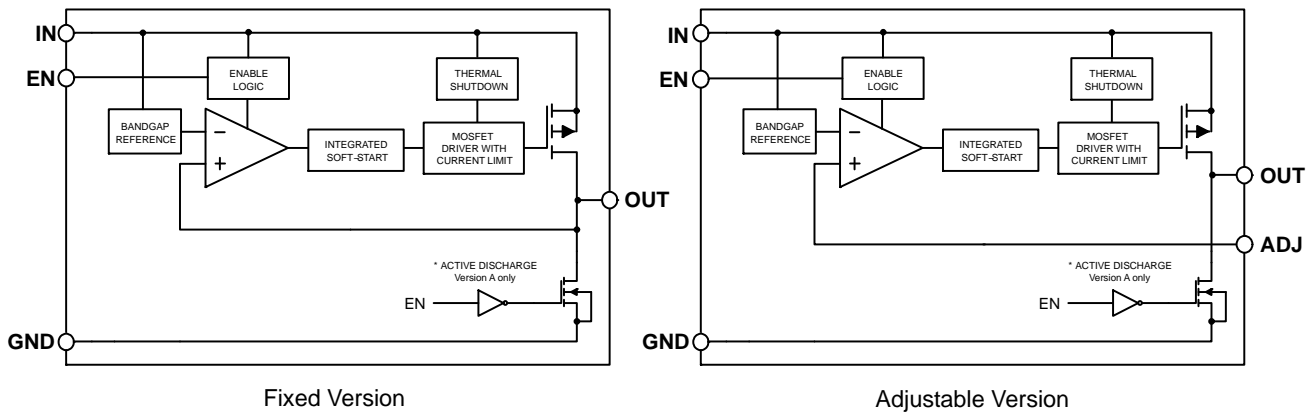

Figure 2. Simplified Block Diagram

Table 1. PIN FUNCTION DESCRIPTION

| Pin No. (WDFN6) | Pin No. (TSOT-23-5) | Pin Name | Description  |
|-----------------|---------------------|----------|--|
| 6               | 1                   | IN       | Input pin. A small capacitor is needed from this pin to ground to assure stability.  |
| 3, EXP          | 2                   | GND      | Power supply ground.   |
| 4               | 3                   | EN       | Enable pin. Driving this pin high turns on the regulator. Driving EN pin low puts the regulator into shutdown mode.  |
| 2               | 4                   | NC / ADJ | Fixed Version: No connection. This pin can be tied to ground to improve thermal dissipation or left disconnected.<br>Adjustable Version: Feedback pin for set-up output voltage. Use resistor divider for voltage selection. |
| 1               | 5                   | OUT      | Regulated output voltage pin. A small 1 $\mu$ F ceramic capacitor is needed from this pin to ground to assure stability.   |
| 5               | -                   | N/C      | No connection. This pin can be tied to ground to improve thermal dissipation or left disconnected.   |

Table 2. ABSOLUTE MAXIMUM RATINGS

| Rating  | Symbol             | Value                         | Unit         |
|---|--------------------|-------------------------------|--------------|
| Input Voltage (Note 1)                        | $V_{IN}$           | -0.3 to 24                    | V            |
| Enable Voltage                                | $V_{EN}$           | -0.3 to $V_{IN}+0.3$          | V            |
| Output Voltage                                | $V_{OUT}$          | -0.3 to $V_{IN}+0.3$ (max. 6) | V            |
| Output Short Circuit Duration                 | $t_{SC}$           | Indefinite                    | s            |
| Maximum Junction Temperature                  | $T_{J(MAX)}$       | 150                           | $^{\circ}$ C |
| Storage Temperature                           | $T_{STG}$          | -55 to 150                    | $^{\circ}$ C |
| ESD Capability, Human Body Model (Note 2)     | ESD <sub>HBM</sub> | 2000                          | V            |
| ESD Capability, Charged Device Model (Note 2) | ESD <sub>CDM</sub> | 1000                          | V            |

Stresses exceeding those listed in the Maximum Ratings table may damage the device. If any of these limits are exceeded, device functionality should not be assumed, damage may occur and reliability may be affected.

1. Refer to ELECTRICAL CHARACTERISTICS and APPLICATION INFORMATION for Safe Operating Area.
2. This device series incorporates ESD protection and is tested by the following methods:  
 ESD Human Body Model tested per AEC-Q100-002 (EIA/JESD22-A114)  
 ESD Charged Device Model tested per EIA/JESD22-C101, Field Induced Charge Model.  
 Latch up Current Maximum Rating tested per JEDEC standard: JESD78. Latch-up is not guaranteed on ENABLE pin.

Table 3. THERMAL CHARACTERISTICS

| Rating   | Symbol          | Value | Unit           |
|--|-----------------|-------|----------------|
| Thermal Characteristics, WDFN6, 2 mm x 2 mm<br>Thermal Resistance, Junction-to-Air | $R_{\theta JA}$ | 65    | $^{\circ}$ C/W |
| Thermal Characteristics, TSOT-23-5<br>Thermal Resistance, Junction-to-Air          | $R_{\theta JA}$ | 235   | $^{\circ}$ C/W |

# NCP718

**Table 4. ELECTRICAL CHARACTERISTICS**  $-40^{\circ}\text{C} \leq T_J \leq 125^{\circ}\text{C}$ ;  $V_{IN} = 2.5\text{ V}$  or  $(V_{OUT} + 1.0\text{ V})$ , whatever is greater;  $I_{OUT} = 1\text{ mA}$ ,  $C_{IN} = C_{OUT} = 1\text{ }\mu\text{F}$ , unless otherwise noted. Typical values are at  $T_J = +25^{\circ}\text{C}$ . (Note 3)

| Parameter                                   | Test Conditions  | Symbol                      | Min  | Typ | Max | Unit                |
|---|--|-----------------------------|------|-----|-----|---------------------|
| Operating Input Voltage                     |  | $V_{IN}$                    | 2.5  |     | 24  | V                   |
| Output Voltage Accuracy<br>(fixed versions) | $-40^{\circ}\text{C} \leq T_J \leq 125^{\circ}\text{C}$ ,<br>$V_{OUT} + 1\text{ V} < V_{IN} < 16\text{ V}$ ,<br>$0.1\text{ mA} < I_{OUT} < 300\text{ mA}$ (Note 5) | $V_{OUT} < 1.8\text{ V}$    | -3%  |     | +3% | V                   |
|   |  | $V_{OUT} \geq 1.8\text{ V}$ | -2%  |     | +2% |                     |
| Reference Voltage                           | $-40^{\circ}\text{C} \leq T_J \leq 125^{\circ}\text{C}$ ,<br>$V_{OUT} + 1\text{ V} < V_{IN} < 16\text{ V}$   | $V_{ADJ}$                   |      | 1.2 |     | V                   |
| Reference Voltage Accuracy                  | $-40^{\circ}\text{C} \leq T_J \leq 125^{\circ}\text{C}$ ,<br>$V_{OUT} + 1\text{ V} < V_{IN} < 16\text{ V}$   | $V_{OUT}$                   | -2%  |     | +2% | V                   |
| Line Regulation                             | $V_{OUT} + 1\text{ V} \leq V_{IN} \leq 16\text{ V}$ , $I_{OUT} = 1\text{ mA}$  | Reg <sub>LINE</sub>         |      | 10  |     | mV                  |
| Load Regulation                             | $I_{OUT} = 0.1\text{ mA}$ to $300\text{ mA}$   | Reg <sub>LOAD</sub>         |      | 10  |     | mV                  |
| Dropout Voltage<br>(Package TSOT-23-5)      | $V_{DO} = V_{IN} - (V_{OUT(NOM)} - 3\%)$ ,<br>$I_{OUT} = 300\text{ mA}$ (Note 4)   | 2.1 V – 2.4 V               |      | 480 |     | mV                  |
|   |  | 2.5 V – 2.7 V               |      | 320 | 490 |                     |
|   |  | 2.8 V – 3.2 V               |      | 295 | 465 |                     |
|   |  | 3.3 V – 4.9 V               |      | 275 | 440 |                     |
|   |  | 5 V                         |      | 250 | 380 |                     |
| Dropout Voltage<br>(Package WDFN6)          | $V_{DO} = V_{IN} - (V_{OUT(NOM)} - 3\%)$ ,<br>$I_{OUT} = 300\text{ mA}$ (Note 4)   | 2.1 V – 2.4 V               |      | 490 |     | mV                  |
|   |  | 2.5 V – 2.7 V               |      | 335 | 505 |                     |
|   |  | 2.8 V – 3.2 V               |      | 305 | 475 |                     |
|   |  | 3.3 V – 4.9 V               |      | 285 | 450 |                     |
|   |  | 5 V                         |      | 260 | 395 |                     |
| Maximum Output Current                      | $V_{IN} = V_{OUT} + 1\text{ V}$ (Note 5)   | $I_{LIM}$                   | 300  |     | 800 | mA                  |
| Disable Current                             | $V_{EN} = 0\text{ V}$ , $V_{IN} = 5\text{ V}$  | $I_{DIS}$                   |      | 0.1 | 1.0 | $\mu\text{A}$       |
| Quiescent Current                           | $I_{OUT} = 0\text{ mA}$ , $-40^{\circ}\text{C} \leq T_J \leq 125^{\circ}\text{C}$  | $I_Q$                       |      | 4.0 | 8.0 | $\mu\text{A}$       |
| Ground current                              | $I_{OUT} = 10\text{ mA}$   | $I_{GND}$                   |      | 50  |     | $\mu\text{A}$       |
|   | $I_{OUT} = 300\text{ mA}$  |                             |      | 300 |     |                     |
| Power Supply Rejection Ratio                | $V_{IN} = 3.5\text{ V} + 100\text{ mVpp}$<br>$V_{OUT} = 2.5\text{ V}$<br>$I_{OUT} = 1\text{ mA}$ , $C_{out} = 1\text{ }\mu\text{F}$                                | $f = 1\text{ kHz}$          | PSRR | 60  |     | dB                  |
| Output Noise Voltage                        | $V_{OUT} = 1.2\text{ V}$ , $I_{OUT} = 10\text{ mA}$<br>$f = 100\text{ Hz}$ to $100\text{ kHz}$   | $V_N$                       |      | 36  |     | $\mu\text{V}_{rms}$ |
| Enable Input Threshold Voltage              | Voltage increasing   | $V_{EN\_HI}$                | 1.2  | –   | –   | V                   |
|   | Voltage decreasing   | $V_{EN\_LO}$                | –    | –   | 0.4 |                     |
| ADJ Pin Current                             | $V_{IN} = V_{OUT} + 1\text{ V}$  | $I_{ADJ}$                   |      | 0.1 | 1.0 | $\mu\text{A}$       |
| EN Pin Current                              | $V_{EN} = 5.5\text{ V}$  | $I_{EN}$                    |      | 100 |     | nA                  |
| Active Output Discharge Resistance          | $V_{IN} = 5.5\text{ V}$ , $V_{EN} = 0\text{ V}$  | $R_{dis}$                   |      | 100 |     | $\Omega$            |
| Thermal Shutdown Temperature<br>(Note 6)    | Temperature increasing from $T_J = +25^{\circ}\text{C}$  | $T_{SD}$                    |      | 165 |     | $^{\circ}\text{C}$  |
| Thermal Shutdown Hysteresis<br>(Note 6)     | Temperature falling from $T_{SD}$  | $T_{SDH}$                   | –    | 25  | –   | $^{\circ}\text{C}$  |

Product parametric performance is indicated in the Electrical Characteristics for the listed test conditions, unless otherwise noted. Product performance may not be indicated by the Electrical Characteristics if operated under different conditions.

3. Performance guaranteed over the indicated operating temperature range by design and/or characterization production tested at  $T_J = T_A = 25^{\circ}\text{C}$ . Low duty cycle pulse techniques are used during testing to maintain the junction temperature as close to ambient as possible.

4. Voltage dropout for voltage variants below 2.1 V is given by minimum input voltage 2.5 V.

5. Respect SOA

6. Guaranteed by design and characterization.

# NCP718

## TYPICAL CHARACTERISTICS

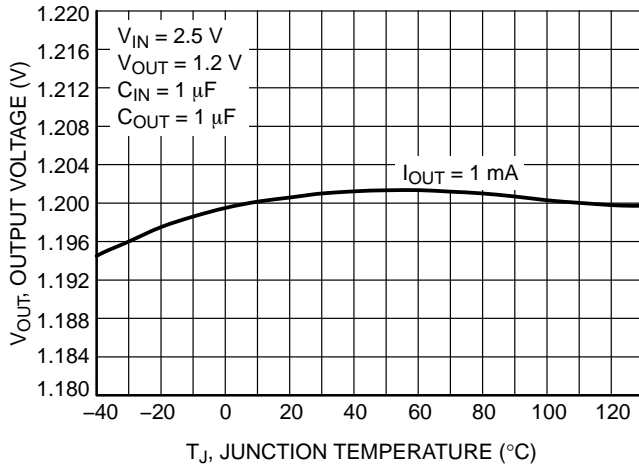

**Figure 3. Output Voltage vs. Temperature –  $V_{OUT} = 1.2\text{ V}$**

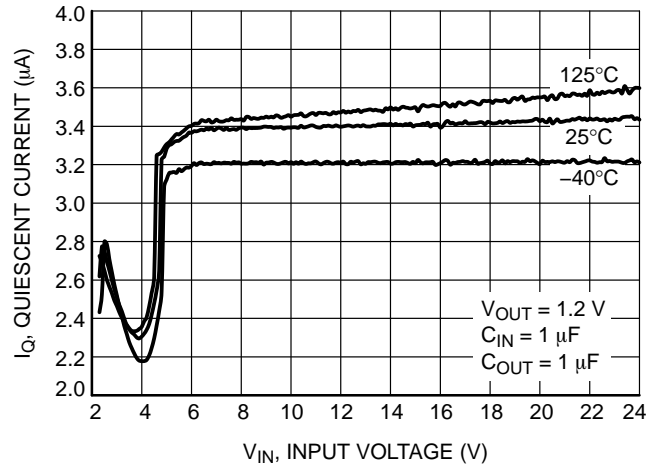

**Figure 4. Quiescent Current vs. Input Voltage**

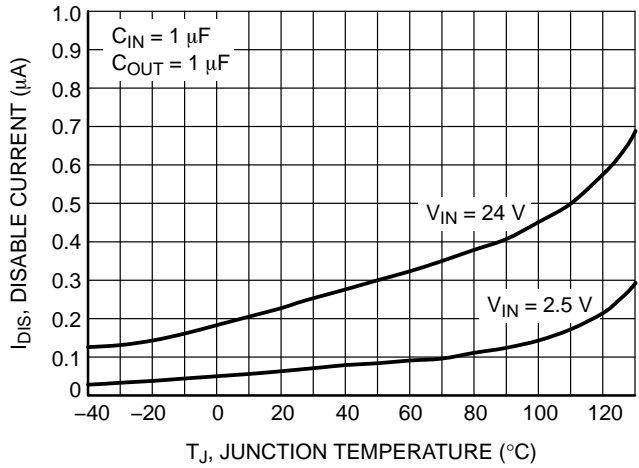

**Figure 5. Disable Current vs. Temperature**

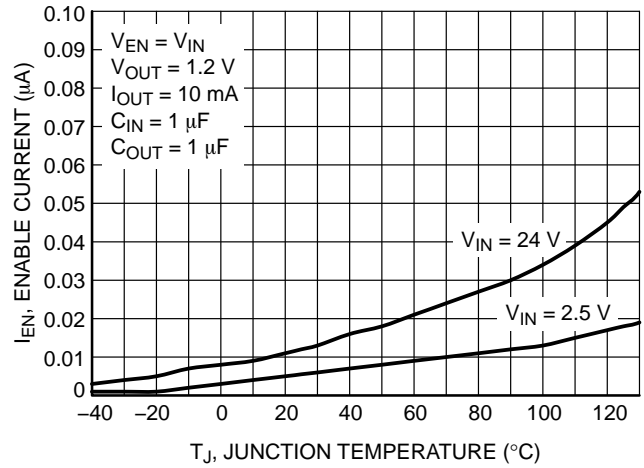

**Figure 6. Current to Enable Pin vs. Temperature**

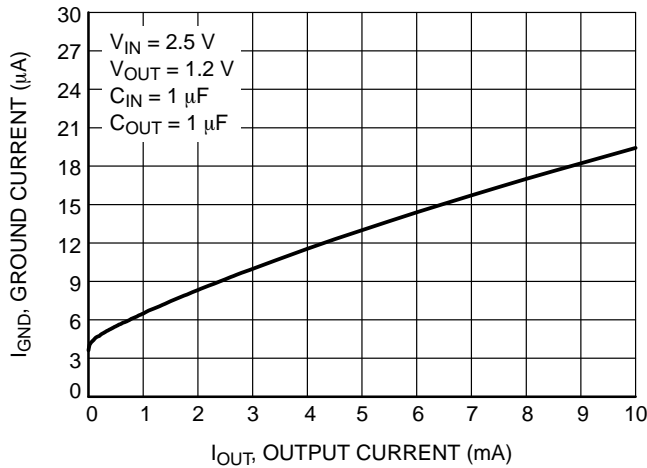

**Figure 7. Ground Current vs. Output Current –  $V_{OUT} = 1.2\text{ V}$**

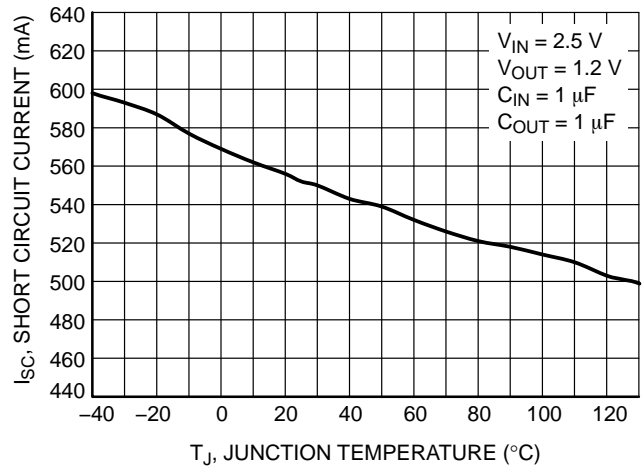

**Figure 8. Short Circuit Current vs. Temperature**

TYPICAL CHARACTERISTICS

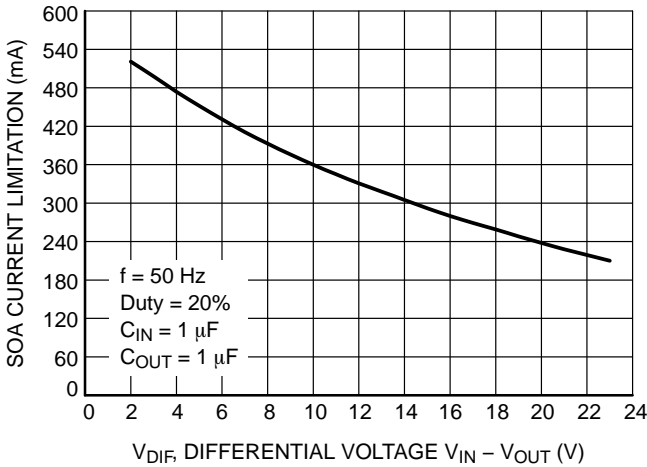

Figure 9. SOA Current Limit vs. Differential Voltage

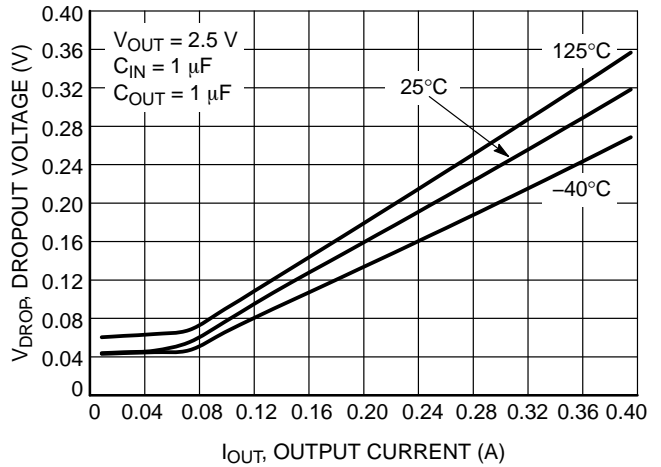

Figure 10. Dropout Voltage vs. Output Current -  $V_{OUT} = 2.5 V$

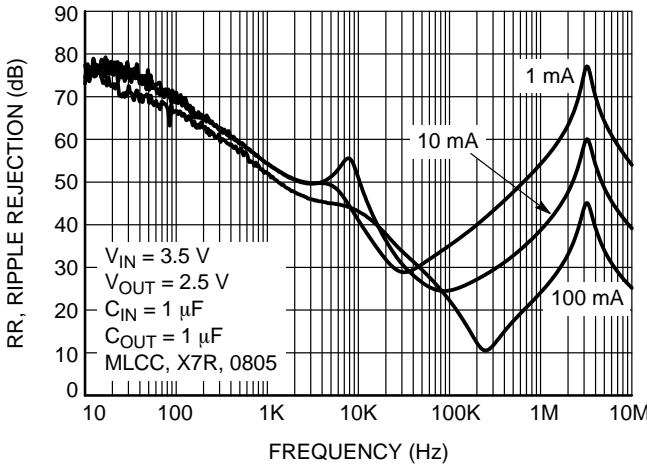

Figure 11. Power Supply Rejection Ratio vs. Current,  $V_{IN} = 3.5 V$ ,  $C_{OUT} = 1 \mu F$

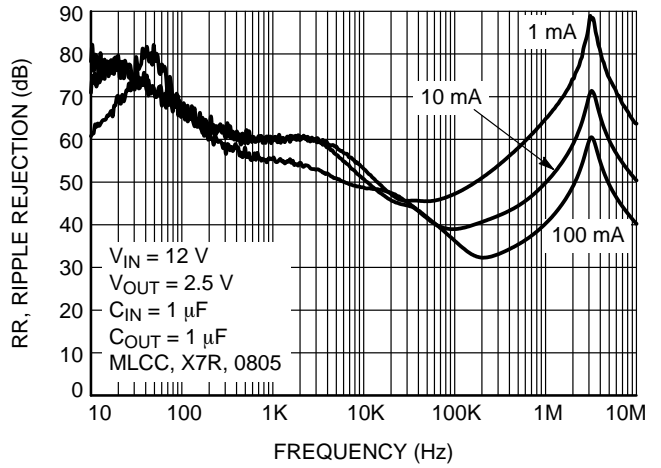

Figure 12. Power Supply Rejection Ratio vs. Current,  $V_{IN} = 12 V$ ,  $C_{OUT} = 1 \mu F$

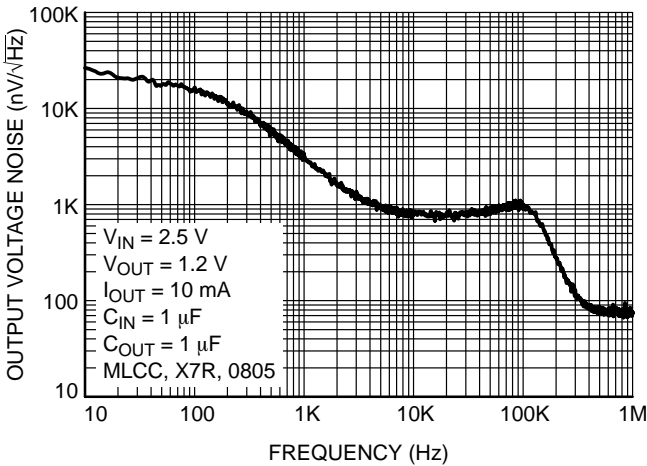

Figure 13. Output Voltage Noise Spectral Density for  $V_{OUT} = 1.2 V$ ,  $I_{OUT} = 10 mA$ ,  $C_{OUT} = 1 \mu F$

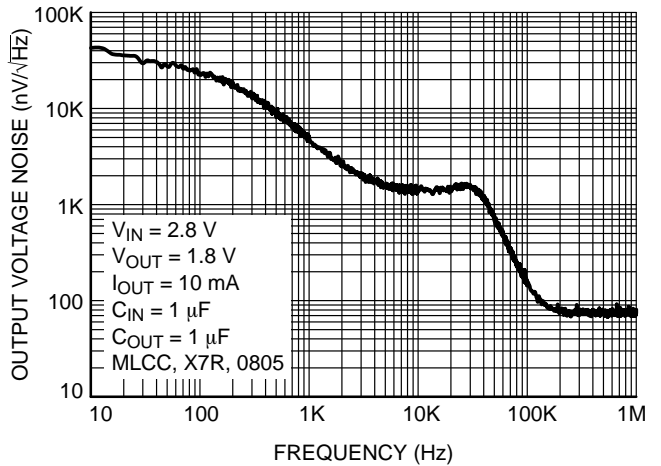

Figure 14. Output Voltage Noise Spectral Density for  $V_{OUT} = 1.8 V$ ,  $I_{OUT} = 10 mA$ ,  $C_{OUT} = 1 \mu F$

# NCP718

## APPLICATIONS INFORMATION

The NCP718 is the member of new family of Wide Input Voltage Range Low Dropout Regulators which delivers Ultra Low Ground Current consumption, Good Noise and Power Supply Rejection Ratio Performance. The NCP718 incorporates EN pin and soft-start feature for simple controlling by microprocessor or logic.

### Input Decoupling ( $C_{IN}$ )

It is recommended to connect at least 1  $\mu\text{F}$  ceramic X5R or X7R capacitor between IN and GND pin of the device. This capacitor will provide a low impedance path for any unwanted AC signals or noise superimposed onto constant input voltage. The good input capacitor will limit the influence of input trace inductances and source resistance during sudden load current changes.

Higher capacitance and lower ESR capacitors will improve the overall line transient response.

### Output Decoupling ( $C_{OUT}$ )

The NCP718 does not require a minimum Equivalent Series Resistance (ESR) for the output capacitor. The device is designed to be stable with standard ceramics capacitors with values of 1  $\mu\text{F}$  or greater. The X5R and X7R types have the lowest capacitance variations over temperature thus they are recommended.

### Power Dissipation and Heat Sinking

The maximum power dissipation supported by the device is dependent upon board design and layout. Mounting pad configuration on the PCB, the board material, and the ambient temperature affect the rate of junction temperature rise for the part. For reliable operation junction temperature should be limited to  $+125^{\circ}\text{C}$ .

The maximum power dissipation the NCP718 can handle is given by:

$$P_{D(\text{MAX})} = \frac{[T_{J(\text{MAX})} - T_A]}{R_{\theta JA}} \quad (\text{eq. 1})$$

The power dissipated by the NCP718 for given application conditions can be calculated from the following equations:

$$P_D \approx V_{IN}(I_{\text{GND}} + I_{\text{OUT}}) + I_{\text{OUT}}(V_{IN} - V_{\text{OUT}}) \quad (\text{eq. 2})$$

or

$$V_{IN(\text{MAX})} \approx \frac{P_{D(\text{MAX})} + (V_{\text{OUT}} \times I_{\text{OUT}})}{I_{\text{OUT}} + I_{\text{GND}}} \quad (\text{eq. 3})$$

### Hints

$V_{IN}$  and GND printed circuit board traces should be as wide as possible. When the impedance of these traces is high, there is a chance to pick up noise or cause the regulator to malfunction. Place external components, especially the output capacitor, as close as possible to the NCP718, and make traces as short as possible.

### ADJUSTABLE VERSION

The output voltage can be set by using a resistor divider as shown in Figure 15 with a range of 1.2 V to 5 V. The appropriate resistor divider can be found by solving the equation below, while  $V_{\text{REF}} = 1.2 \text{ V}$

$$V_{\text{OUT}} = V_{\text{REF}} \cdot \frac{(R1 + R2)}{R1} = V_{\text{REF}} \cdot \left(1 + \frac{R2}{R1}\right) \quad (\text{eq. 4})$$

Value of R1 and R2 is recommended to keep below 100 k $\Omega$  for R1 and below 1 M $\Omega$  for R2 to avoid influence of current  $I_{\text{ADJ}}$  variation over temperature range.

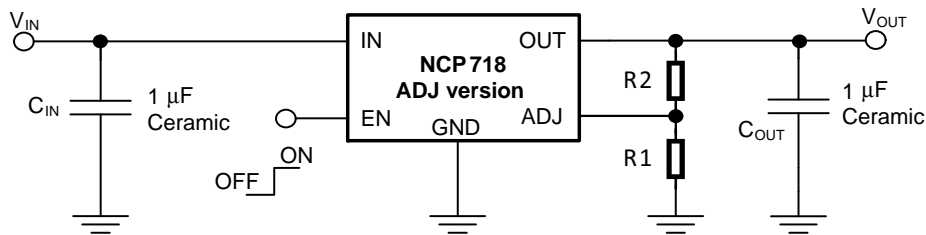

Figure 15. Adjustable Version Connection Schematic

Please note that output noise is amplified by  $V_{\text{OUT}}/V_{\text{ADJ}}$  ratio. For simplified calculation, output noise is equal to

$30 \mu\text{V}_{\text{RMS}} * V_{\text{OUT}}$ . Do not operate the device at output voltage about 5.2 V, as device can be damaged.

# NCP718

## ORDERING INFORMATION

| Device Part No. | Voltage Option | Marking | Option                          | Package                | Shipping†          |
|-----------------|----------------|---------|---------------------------------|------------------------|--------------------|
| NCP718AMTADJTBG | Adj.           | GA      | With Active Output Discharge    | WDFN6<br>(Pb-Free)     | 3000 / Tape & Reel |
| NCP718AMT120TBG | 1.2 V          | GN      |                                 |                        |                    |
| NCP718AMT180TBG | 1.8 V          | GP      |                                 |                        |                    |
| NCP718AMT250TBG | 2.5 V          | GD      |                                 |                        |                    |
| NCP718AMT300TBG | 3.0 V          | GQ      |                                 |                        |                    |
| NCP718AMT330TBG | 3.3 V          | GR      |                                 |                        |                    |
| NCP718AMT500TBG | 5.0 V          | GM      |                                 |                        |                    |
| NCP718BMTADJTBG | Adj.           | GC      | Without Active Output Discharge | WDFN6<br>(Pb-Free)     | 3000 / Tape & Reel |
| NCP718BMT180TBG | 1.8 V          | GU      |                                 |                        |                    |
| NCP718BMT300TBG | 3.0 V          | GV      |                                 |                        |                    |
| NCP718BMT330TBG | 3.3 V          | GW      |                                 |                        |                    |
| NCP718BMT500TBG | 5.0 V          | GE      |                                 |                        |                    |
| NCP718ASNADJT1G | Adj.           | GAA     | With Active Output Discharge    | TSOT-23-5<br>(Pb-Free) | 3000 / Tape & Reel |
| NCP718ASN120T1G | 1.2 V          | GAE     |                                 |                        |                    |
| NCP718ASN150T1G | 1.5 V          | GAF     |                                 |                        |                    |
| NCP718ASN180T1G | 1.8 V          | GAD     |                                 |                        |                    |
| NCP718ASN250T1G | 2.5 V          | GAG     |                                 |                        |                    |
| NCP718ASN300T1G | 3.0 V          | GAH     |                                 |                        |                    |
| NCP718ASN330T1G | 3.3 V          | GAJ     |                                 |                        |                    |
| NCP718ASN500T1G | 5.0 V          | GAK     |                                 |                        |                    |
| NCP718BSNADJT1G | Adj.           | GAC     | Without Active Output Discharge | TSOT-23-5<br>(Pb-Free) | 3000 / Tape & Reel |
| NCP718BSN120T1G | 1.2 V          | GCA     |                                 |                        |                    |
| NCP718BSN150T1G | 1.5 V          | GCC     |                                 |                        |                    |
| NCP718BSN180T1G | 1.8 V          | GCD     |                                 |                        |                    |
| NCP718BSN250T1G | 2.5 V          | GCF     |                                 |                        |                    |
| NCP718BSN300T1G | 3.0 V          | GCG     |                                 |                        |                    |
| NCP718BSN330T1G | 3.3 V          | GCH     |                                 |                        |                    |
| NCP718BSN500T1G | 5.0 V          | GCE     |                                 |                        |                    |

†For information on tape and reel specifications, including part orientation and tape sizes, please refer to our Tape and Reel Packaging Specifications Brochure, BRD8011/D.

# MECHANICAL CASE OUTLINE

## PACKAGE DIMENSIONS

ON Semiconductor®



TSOT-23, 5 LEAD  
CASE 419AE-01  
ISSUE O

DATE 19 DEC 2008

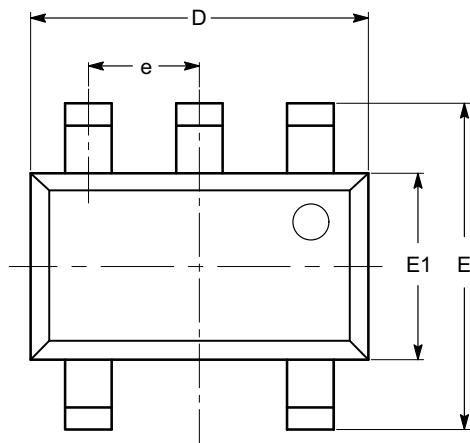

TOP VIEW

| SYMBOL   | MIN      | NOM  | MAX  |
|----------|----------|------|------|
| A        |          |      | 1.00 |
| A1       | 0.01     | 0.05 | 0.10 |
| A2       | 0.80     | 0.87 | 0.90 |
| b        | 0.30     |      | 0.45 |
| c        | 0.12     | 0.15 | 0.20 |
| D        | 2.90 BSC |      |      |
| E        | 2.80 BSC |      |      |
| E1       | 1.60 BSC |      |      |
| e        | 0.95 TYP |      |      |
| L        | 0.30     | 0.40 | 0.50 |
| L1       | 0.60 REF |      |      |
| L2       | 0.25 BSC |      |      |
| $\theta$ | 0°       |      | 8°   |

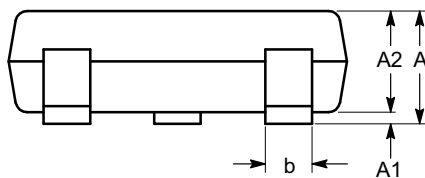

SIDE VIEW

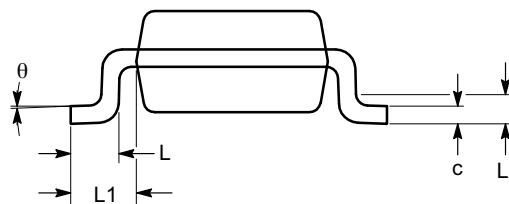

END VIEW

**Notes:**

- (1) All dimensions are in millimeters. Angles in degrees.
- (2) Complies with JEDEC MO-193.

|                         |                        |  |
|-------------------------|------------------------|--|
| <b>DOCUMENT NUMBER:</b> | <b>98AON34392E</b>     | Electronic versions are uncontrolled except when accessed directly from the Document Repository. Printed versions are uncontrolled except when stamped "CONTROLLED COPY" in red. |
| <b>DESCRIPTION:</b>     | <b>TSOT-23, 5 LEAD</b> | <b>PAGE 1 OF 1</b>   |

ON Semiconductor and are trademarks of Semiconductor Components Industries, LLC dba ON Semiconductor or its subsidiaries in the United States and/or other countries. ON Semiconductor reserves the right to make changes without further notice to any products herein. ON Semiconductor makes no warranty, representation or guarantee regarding the suitability of its products for any particular purpose, nor does ON Semiconductor assume any liability arising out of the application or use of any product or circuit, and specifically disclaims any and all liability, including without limitation special, consequential or incidental damages. ON Semiconductor does not convey any license under its patent rights nor the rights of others.





SCALE 4:1

**WDFN6 2x2, 0.65P**  
**CASE 511BR**  
**ISSUE B**

DATE 19 JAN 2016

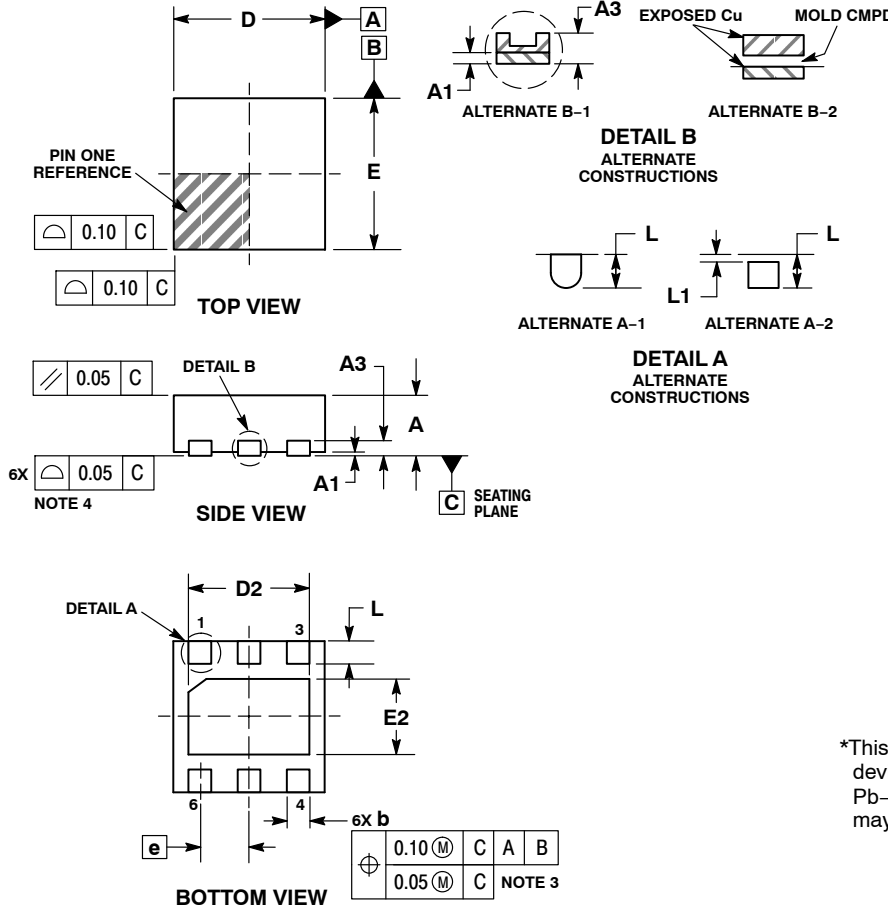

- NOTES:
1. DIMENSIONING AND TOLERANCING PER ASME Y14.5M, 1994.
  2. CONTROLLING DIMENSION: MILLIMETERS.
  3. DIMENSION b APPLIES TO PLATED TERMINAL AND IS MEASURED BETWEEN 0.15 AND 0.25 mm FROM THE TERMINAL TIP.
  4. COPLANARITY APPLIES TO THE EXPOSED PAD AS WELL AS THE TERMINALS.
  5. FOR DEVICES CONTAINING WETTABLE FLANK OPTION, DETAIL A ALTERNATE CONSTRUCTION A-2 AND DETAIL B ALTERNATE CONSTRUCTION B-2 ARE NOT APPLICABLE.

| DIM | MILLIMETERS |      |
|-----|-------------|------|
|     | MIN         | MAX  |
| A   | 0.70        | 0.80 |
| A1  | 0.00        | 0.05 |
| A3  | 0.20        | REF  |
| b   | 0.25        | 0.35 |
| D   | 2.00        | BSC  |
| D2  | 1.50        | 1.70 |
| E   | 2.00        | BSC  |
| E2  | 0.90        | 1.10 |
| e   | 0.65        | BSC  |
| L   | 0.20        | 0.40 |
| L1  | ---         | 0.15 |

**GENERIC MARKING DIAGRAM\***

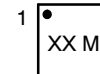

XX = Specific Device Code  
M = Date Code

\*This information is generic. Please refer to device data sheet for actual part marking. Pb-Free indicator, "G" or microdot "▪", may or may not be present.

**RECOMMENDED MOUNTING FOOTPRINT**

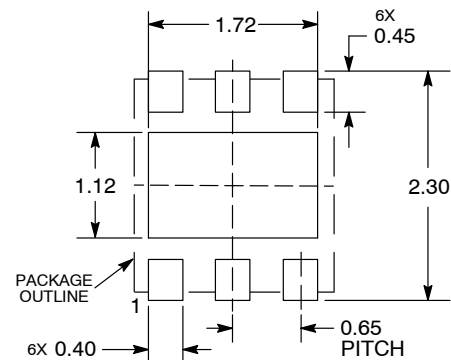

DIMENSIONS: MILLIMETERS

|                         |                         |  |
|-------------------------|-------------------------|--|
| <b>DOCUMENT NUMBER:</b> | <b>98AON55829E</b>      | Electronic versions are uncontrolled except when accessed directly from the Document Repository. Printed versions are uncontrolled except when stamped "CONTROLLED COPY" in red. |
| <b>DESCRIPTION:</b>     | <b>WDFN6 2X2, 0.65P</b> | <b>PAGE 1 OF 1</b>   |

ON Semiconductor and are trademarks of Semiconductor Components Industries, LLC dba ON Semiconductor or its subsidiaries in the United States and/or other countries. ON Semiconductor reserves the right to make changes without further notice to any products herein. ON Semiconductor makes no warranty, representation or guarantee regarding the suitability of its products for any particular purpose, nor does ON Semiconductor assume any liability arising out of the application or use of any product or circuit, and specifically disclaims any and all liability, including without limitation special, consequential or incidental damages. ON Semiconductor does not convey any license under its patent rights nor the rights of others.

ON Semiconductor and  are trademarks of Semiconductor Components Industries, LLC dba ON Semiconductor or its subsidiaries in the United States and/or other countries. ON Semiconductor owns the rights to a number of patents, trademarks, copyrights, trade secrets, and other intellectual property. A listing of ON Semiconductor's product/patent coverage may be accessed at [www.onsemi.com/site/pdf/Patent-Marking.pdf](http://www.onsemi.com/site/pdf/Patent-Marking.pdf). ON Semiconductor reserves the right to make changes without further notice to any products herein. ON Semiconductor makes no warranty, representation or guarantee regarding the suitability of its products for any particular purpose, nor does ON Semiconductor assume any liability arising out of the application or use of any product or circuit, and specifically disclaims any and all liability, including without limitation special, consequential or incidental damages. Buyer is responsible for its products and applications using ON Semiconductor products, including compliance with all laws, regulations and safety requirements or standards, regardless of any support or applications information provided by ON Semiconductor. "Typical" parameters which may be provided in ON Semiconductor data sheets and/or specifications can and do vary in different applications and actual performance may vary over time. All operating parameters, including "Typicals" must be validated for each customer application by customer's technical experts. ON Semiconductor does not convey any license under its patent rights nor the rights of others. ON Semiconductor products are not designed, intended, or authorized for use as a critical component in life support systems or any FDA Class 3 medical devices or medical devices with a same or similar classification in a foreign jurisdiction or any devices intended for implantation in the human body. Should Buyer purchase or use ON Semiconductor products for any such unintended or unauthorized application, Buyer shall indemnify and hold ON Semiconductor and its officers, employees, subsidiaries, affiliates, and distributors harmless against all claims, costs, damages, and expenses, and reasonable attorney fees arising out of, directly or indirectly, any claim of personal injury or death associated with such unintended or unauthorized use, even if such claim alleges that ON Semiconductor was negligent regarding the design or manufacture of the part. ON Semiconductor is an Equal Opportunity/Affirmative Action Employer. This literature is subject to all applicable copyright laws and is not for resale in any manner.

## PUBLICATION ORDERING INFORMATION

### LITERATURE FULFILLMENT:

Email Requests to: [orderlit@onsemi.com](mailto:orderlit@onsemi.com)

ON Semiconductor Website: [www.onsemi.com](http://www.onsemi.com)

### TECHNICAL SUPPORT

North American Technical Support:  
Voice Mail: 1 800-282-9855 Toll Free USA/Canada  
Phone: 011 421 33 790 2910

Europe, Middle East and Africa Technical Support:

Phone: 00421 33 790 2910

For additional information, please contact your local Sales Representative