

Inductive Proximity Sensor - 25mm Square Plastic Housing **multicomp** PRO

**RoHS
Compliant**



Features

- Inductive sensor, style: squared shape, 25mm × 25mm × 39mm
- Mounting distance: 8mm shielded
- With LED operation indicate lamp, easily identifiable
- Standard sensing object: ferrous metals
- Protection rate: IP67, water resistant
- Over-current and short circuit protection; against polarity reversal.
- Widely applied in measuring, Counting, Rpm measuring in mechanism, chemical, paper manufacture light industry, etc.

Specifications

Mounting Distance	: 8mm shielded
Sensing Distance	: 7.2mm shielded
Power Supply	: 10V DC to 30V DC / 90V AC to 250V AC
Frequency	: 80Hz / 40Hz / 20Hz (DC 3/2 wires, AC 2 wires)
Current Output (DC/AC)	: 200mA / 300mA
Ambient Temperature	: -15°C to 60°C
Against Polarity Reversal	: Yes
Short Circuit Protected	: Yes
IP Rating	: IP67

Electrical Connection

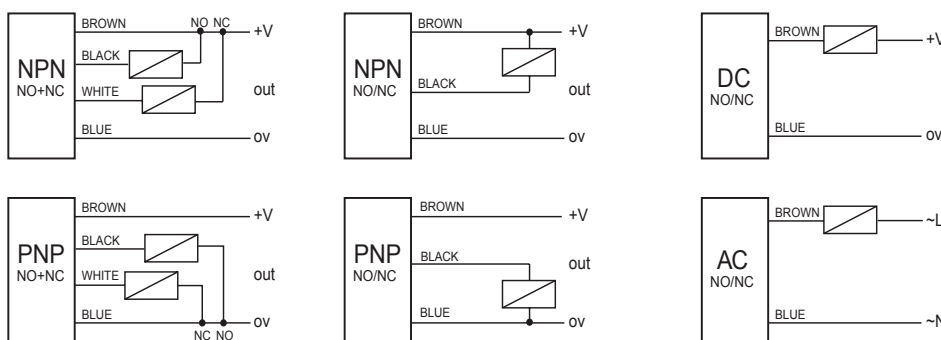

Picture of Product

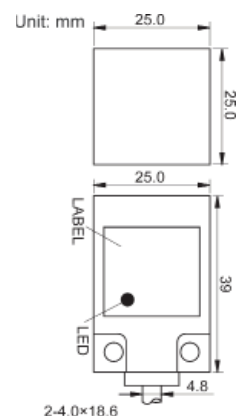

Inductive Proximity Sensor - 25mm Square Plastic Housing **multicomp** PRO

Installation

If used in an area surrounded by metal, Install the proximity Sensor as follows . (Sn = Sensing distance)

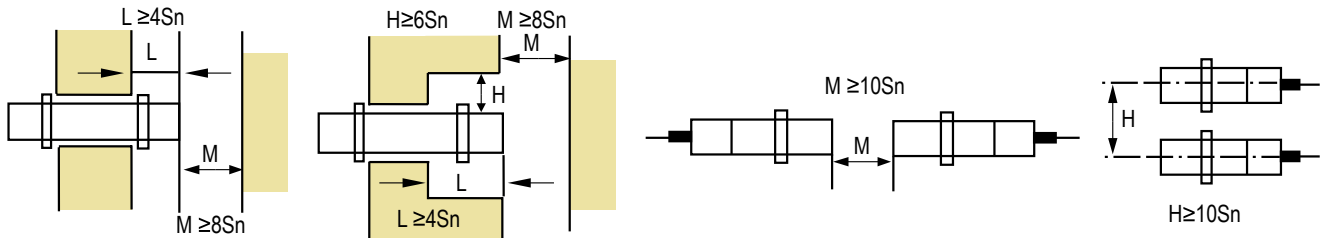

Inductive Proximity Application Direction

- A. Set mounting distance equal to 80% of Sn.
- B. Set mounting distance roughly equal to 50% of Sn when sensor is used in high frequency or high speed circumstances.
- C. Mounting distance will change depending on material (iron, stainless steel, brass, copper and aluminium).

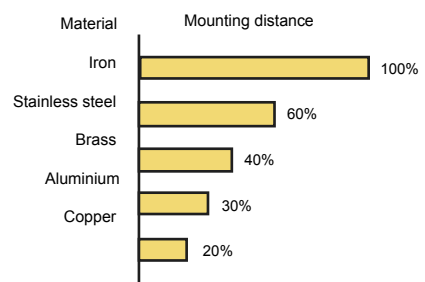
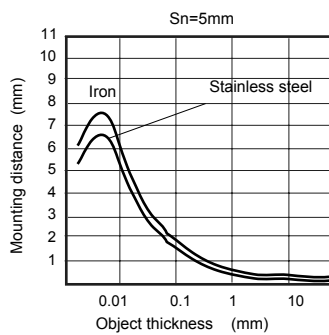
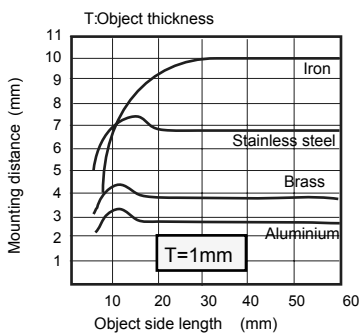

D. Ips series connection and parallel connection.

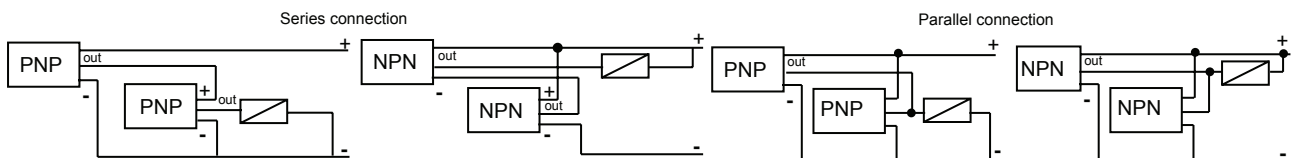

Inductive Proximity Sensor - 25mm Square Plastic Housing **multicomp**^{PRO}

Part Number Table

Part Number	Output Type	Mounting Distance	Current Output	Power Supply	Wire Connector
MP002239	PNP NO	8mm Shielded	≤ 200mA/300mA	24V DC / 220V AC	3 Wire
MP002240	PNP NC				3 Wire
MP002241	PNP NO + NC				4 Wire
MP002242	NPN NO				3 Wire
MP002243	NPN NC				3 Wire
MP002244	NPN NO + NC				4 Wire
MP002245	DC NO		≤ 200mA	24V DC	2 Wire
MP002246	DC NC				
MP002247	AC NO			220V AC	
MP002248	AC NC				

Important Notice : This data sheet and its contents (the "Information") belong to the members of the AVNET group of companies (the "Group") or are licensed to it. No licence is granted for the use of it other than for information purposes in connection with the products to which it relates. No licence of any intellectual property rights is granted. The Information is subject to change without notice and replaces all data sheets previously supplied. The Information supplied is believed to be accurate but the Group assumes no responsibility for its accuracy or completeness, any error in or omission from it or for any use made of it. Users of this data sheet should check for themselves the Information and the suitability of the products for their purpose and not make any assumptions based on information included or omitted. Liability for loss or damage resulting from any reliance on the Information or use of it (including liability resulting from negligence or where the Group was aware of the possibility of such loss or damage arising) is excluded. This will not operate to limit or restrict the Group's liability for death or personal injury resulting from its negligence. Multicomp Pro is the registered trademark of Premier Farnell Limited 2019.

Newark.com/multicomp-pro
Farnell.com/multicomp-pro
Element14.com/multicomp-pro

multicomp^{PRO}