Si4700/01/02/03 EVALUATION BOARD USER'S GUIDE

1. Introduction—Si4700/01/02/03 EVB

Thank you for purchasing the Silicon Laboratories, Inc. Si4700/01/02/03 FM Tuner Evaluation Board (EVB). This EVB and associated software have been designed to speed the overall development process and decrease the required development time from EVB to product launch. We have posted support articles, answers to frequently asked questions, and application notes at <https://www.mysilabs.com>.

The Si4700/01/02/03 EVB kit should include the following important items:

- Si4700/01/02/03 FM Tuner customer welcome and evaluation letter
- Si4700/01/02/03 baseboard Revision 1.2
- Si4700/01/02/03 daughter card with pre-mounted Si4700/01 Revision 1.3 or Si4702/03 Revision 1.1
- Wall transformer certified at 5 V/2 A, 100–240 V ac input and power input terminal (green)
- USB cable
- BNC to RCA adapters (2)
- RCA to 1/8" jack cable
- 1/8" barrel adapter (1)
- EVB Characterization Report
- Si4700/01/02/03 Quick Start Guide
- Si4700/01/02/03 CD including:
 - Data sheet
 - Development application GUI

Note: This version of the document supports the third generation of the GUI software. Boards shipped prior to May 2006 may be reprogrammed to use this new GUI. Instructions for doing so can be found on mysilabs.com. For details on the first generation GUI, please reference the 0.2 version of this document, also available on <https://www.mysilabs.com>.

2. Overview

The Si4700/01/02/03 Evaluation Kit includes an evaluation board (EVB) to facilitate evaluation of the Si4700/01/02/03 using the associated software. The EVB consists of a baseboard with a pre-mounted daughter card. The Si4700/01/02/03 is pre-installed on the daughter card. The Si4700 and Si4701 come in a 4 x 4 mm 24-pin QFN package and the Si4702 and Si4703 come in a 3 x 3 mm 20-pin QFN package. The Si4701 and Si4703 offer RDS support, while the Si4700 and Si4702 do not. Several input/output (I/O) connections provide access to the various subsystems on the EVB. Refer to Figure 1 for the locations of the various I/O connectors/devices.

This document references the Si4700/01 data sheet and the Si4702/03 data sheet.

TABLE OF CONTENTS

<u>Section</u>	<u>Page</u>
1. Introduction—Si4700/01/02/03 EVB	1
2. Overview	1
3. Description	4
3.1. Si4700/01/02/03 Baseboard	5
3.2. Si4700/01/02/03 Daughter Card	6
4. EVB Configuration Matrix	7
5. Hardware Setup	9
6. Getting Started—Software Installation	10
6.1. Connecting to the EVB	11
6.2. Running the Software	13
7. Schematics	28
8. Layout	31
8.1. Baseboard	31
8.2. Si4700/01 Daughter Card	34
8.3. Si4702/03 Daughter Card	37
9. Bill of Materials	40
9.1. Bill of Materials - Baseboard	40
9.2. Bill of Materials—Si4700/01 Daughter Card	41
9.3. Bill of Materials—Si4702/03 Daughter Card	42
Document Change List	43
Contact Information	44

Si4700/01/02/03-EVB

3. Description

The following sections refer to both the image in Figure 1 and the silk screen on the Si4700/01/02/03 EVB. It is recommended to refer to both when using this guide.

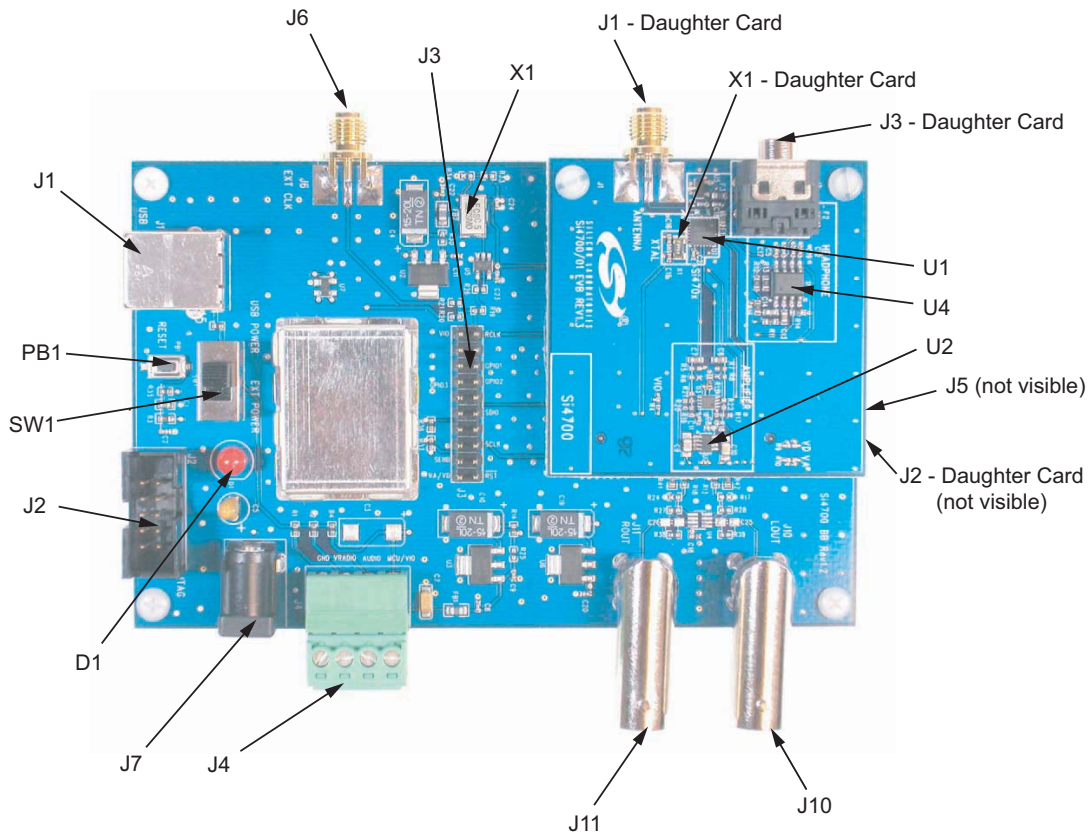

Figure 1. Locations of I/O Connectors/Devices

Baseboard I/O connectors/devices:

- J1 USB connector for USB interface
- J2 JTAG connector for the C8051F320 MCU
- J3 20-pin Expansion I/O connector
- J4 Power input terminal block
- J5 Baseboard card connector (not visible when the baseboard and daughter card are mated)
- J6 SMA connector for external 32.768 kHz RCLK clock input
- J7 2.1 mm power connector
- J10 BNC connector for left audio output
- J11 BNC connector for right audio output
- PB1 Push-button to reset the C8051F320 MCU
- D1 LED to confirm power supply to the C8051F320 MCU

SW1 USB (J7–J4) power selection switch

Daughter card I/O connectors/devices:

- J1 SMA connector for RF (single-ended or non-inverting differential) input
- J2 Baseboard connector (not visible when the baseboard and daughter card are mated)
- J3 Stereo headphone connector for audio output and antenna input
- U1 Si4700/01/02/03
- U2 LOUT/ROUT audio op-amp
- U4 Headphone audio op-amp
- U5 Schmidt trigger buffer (not visible)
- X1 Daughter card 32.768 kHz crystal.

The EVB consists of various subsystems that are explained in greater detail in the following sections.

- X1 Baseboard 32.768 kHz crystal oscillator

3.1. Si4700/01/02/03 Baseboard

3.1.1. Microcontroller and Associated Peripherals

The Si4700/01/02/03 evaluation board uses a Silicon Laboratories' C8051F320 microcontroller to control the Si4700/01/02/03 and to provide USB connectivity to the EVB (via J1). The LED D1 blinks to confirm that power is being properly supplied to the C8051F320 and the MCU firmware has loaded. Push-button PB1 manually resets the C8051F320. The JTAG connector J2 is used to program the C8051F320 at production time, and is not necessary for normal operation. J2 can be used for downloading example code or updating the MCU firmware. See www.mysilabs.com for details.

3.1.2. Reference Clock for the Si4700/01/02/03

The Si4700/01/02/03 accepts a 32.768 kHz reference clock input at the RCLK pin. On the baseboard, this clock is provided by a precision crystal oscillator. The output of the oscillator is routed to the Si4700/01/02/03 RCLK pin through a Schmitt-trigger buffer (U5) and a 33 Ω series termination resistor (R19). The user has the option of not using the oscillator and bringing in the reference clock from an external source through J6. This can be achieved by depopulating R19 and populating R21 with a 0 Ω resistor as shown in Table 1. Note that the reference clock is not routed through the Schmitt-trigger buffer when an external clock source is being used. A third option is available which takes advantage of the Si4700/01/02/03 internal oscillator. This can be achieved by depopulating R2 and R3 on the bottom of the daughter card.

3.1.3. Power Supply Network

When the EVB is used in its simplest configuration, SW1 can be set to USB POWER and powered via the USB connector, J1, or to EXT POWER and powered via the ac connector J7 and included transformer. No additional configuration is required beyond selecting the position of SW1.

J7 is a 2.1 mm power jack for use with standard transformer power bricks. The power brick must be dc and provide at least 5 V on the inner conductor. The regulators on the baseboard are capable of handling up to 26 V, so most dc power bricks are acceptable. To power the board via J7, SW1 must be in the EXT POWER position and no power should be applied via J4. This configuration is convenient when using the JTAG header to program custom code into the C8051F320.

For additional flexibility in usage and testing, the baseboard can accept power from up to 3 independent power supplies via connector J4. When connecting one or more power supplies to connector J4, care must be taken not to supply power via J1 (USB POWER) or J7 (EXT POWER). When connecting more than one power supply to connector J4, care must be taken to configure R1, R2, and R4. See the Figure 2 for reference.

J4 provides flexibility for varying the 3 separate supplies on the board: VRADIO, VAUDIO, and VIO/VMCU. VRADIO is applied to the VA and VD pins of the Si4700/01/02/03, VAUDIO powers the audio amplifier network, and VIO/VMCU powers the baseboard microcontroller, the reference clock system, and VIO on the Si4700/01/02/03. Prior to using J4 it is necessary to remove R1, R2, and R4 as these resistors short the three connections on J4 together.

When supplying VIO/VMCU via the J4 connector, a supply > 5 V may be used in conjunction with the 3.3 V LDO regulator U2. However, U2 may be bypassed by depopulating U2 and populating R30 with a 0 Ω resistor. In this case, the VMCU/VIO supply at J4 must lie between 3.0 and 3.6 V. **This condition is necessary to ensure reliable operation of the C8051F320.**

When supplying VRADIO via the J4 connector, a supply > 5 V may be used in conjunction with the 3.3 V LDO regulator U3. However, U3 may be bypassed by depopulating R14 and populating R25 with a 0 Ω resistor. In such a case, the VRADIO supply at J4 must lie between 2.7 and 5.5 V. **These are the recommended operating conditions for the Si4700/01/02/03.**

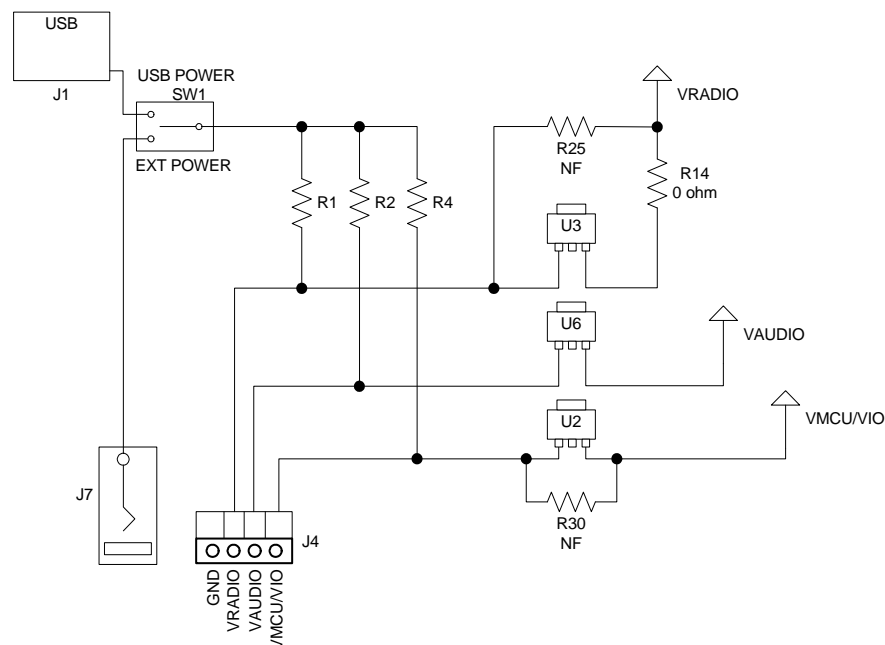

Figure 2. Power Configuration

3.1.4. Expansion I/O connector

The 20-pin Expansion I/O connector J3 provides access to all the control signals of the Si4700/01/02/03 including the general purpose input/output pins. Pins for the VA, VD, VIO, and RCLK pins of the Si4700/01/02/03 are also available. All test points on J3 are labeled indicating the signal available at the pin.

Note: The unlabeled pins on J3 between (a) SCLK and $\overline{\text{RST}}$, and (b) RCLK and GPIO1, provide access to the system ground.

3.2. Si4700/01/02/03 Daughter Card

3.2.1. Si4700/01/02/03 FM Tuner Chip

The Si4700/01/02/03 (U1) and its bypass capacitors* are located on the daughter card. The Si4700/01/02/03 is configured to accept a single-ended FM input—the FMIP pin is grounded and the FMIP pin is connected to J1 through an ac-coupling capacitor. FMIP is also connected to the ground wire of the headphone jack (J3) for easy testing of a headphone wire as the antenna. Refer to “AN231: Si4700/01 Headphone and Antenna Interface” for more information.

***Note:** We recommend a single bypass capacitor on VD. To account for various supply designs and layouts, we recommend that customers make provisions for bypass capacitors at all supply pins.

3.2.2. Audio Amplifier

The daughter card includes a high-output drive dual op-amp chip (U2—daughter card) to buffer the audio outputs at the LOUT and ROUT pins of the Si4700/01/02/03. The LOUT and ROUT pins are also ac-coupled to the inputs of the op-amps on U4 - daughter card. To drive the headphone jack, the op-amps are connected in a unity-gain, noninverting configuration and biased at the middle of the audio power supply. The outputs of the U2 op-amps are in turn ac-coupled to the BNC connectors J10 and J11 on the baseboard.

The audio amplification network has been designed to drive resistances of 10 k Ω which is easily achievable on most audio analyzers. The op-amps have enough drive capability to drive resistances much lower than 10 k Ω (e.g. 32 Ω headphones). In such cases, however, the lower end of the audio spectrum (up to 2.5 kHz) will be attenuated. This is because the 3-dB points of the high-pass filters at the outputs of the op-amps move to higher frequencies as the output resistance is decreased. Also note that the op-amps are not protected against extended short-circuit conditions. Hence, the audio outputs at J10 and J11 should not be connected to a mono input if the Si4700/01/02/03 is configured to produce a stereo output.

4. EVB Configuration Matrix

Table 1 lists the configuration options the EVB provides, the hardware changes necessary to implement a certain option, and any associated constraints. Figure 3 shows the locations of the various components required to configure the EVB.

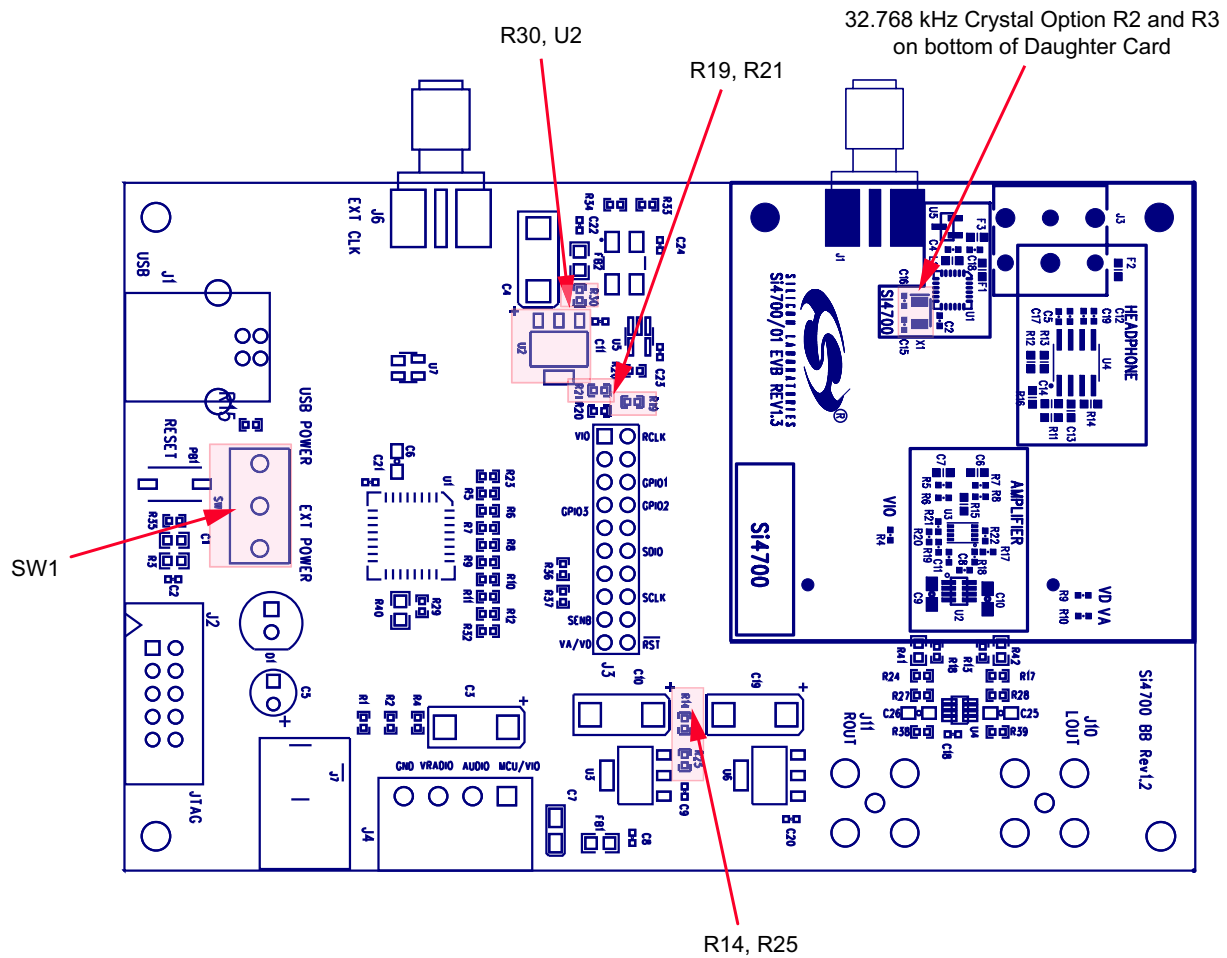

Figure 3. Locations of Components Used to Configure the EVB

Table 1. EVB Configuration Matrix

#	Configuration Variable	Value of Configuration Variable	Hardware Changes	Constraints
1	Reference clock source	Oscillator on baseboard.	None (Default option).	None
2	Reference clock source	External clock through J6.	Depopulate R19 and populate R21 with a 0 Ω resistor.	32.768 kHz, CMOS switching levels at VIO supply level.
3	Reference clock source	On-chip internal oscillator utilizing crystal on daughter card.	Depopulate R2 and R3 from bottom of Si4700/01/02/03 daughter card.	GPIO3 is no longer available and XOSCEN must be selected when starting the GUI.
4*	Power supply source	USB; J1.	Position switch, SW1, to USB POWER.	Cannot supply any voltages via J4.
5*	Power supply source	Power brick; J7.	Position switch, SW1, to EXT POWER.	Cannot supply any voltages via J4. Power brick must supply 5–26 V.
6*	Power supply source	Bench supply; J4.	Depopulate R1, R2, and R4.	See Section 3.1.3.
7	VIO source	Output of U2.	None (Default option).	5–26 V input using configuration option 4, 5, or 6.
8	VIO source	Direct from VMCU/VIO terminal of J4.	Depopulate U2 and populate R30 with a 0 Ω resistor.	3.0–3.6 V input at VMCU/VIO terminal of J4. Can only be used in conjunction with configuration option #6.
9	VA/VD source	Output of U3.	None (Default option).	5–26 V input using configuration option 4, 5, or 6.
10	VA/VD source	Direct from VRADIO terminal of J5.	Depopulate R14 and populate R25 with a 0 Ω resistor.	2.7–5.5 V input at VMCU/VIO terminal of J4. Can only be used in conjunction with configuration option #6.
<p>*Note: For more information, see Section "3.1.3. Power Supply Network" on page 5.</p>				

5. Hardware Setup

The EVB is connected to a PC, which is running the associated software, as shown in Figure 4.

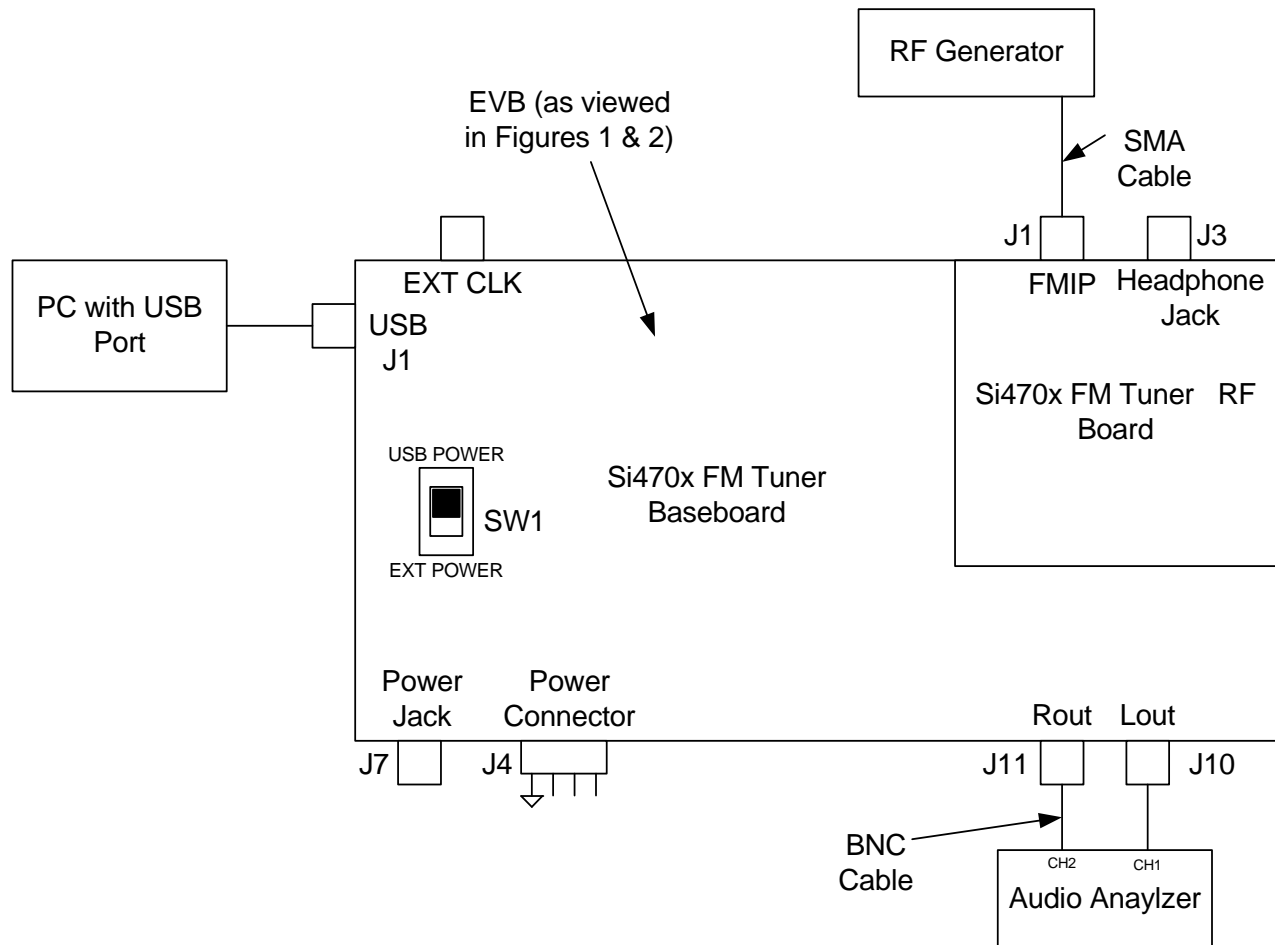

Figure 4. Hardware Setup

1. Connect a SMA cable to the SMA connector J1 on the daughter card and apply the desired FM input.
2. Connect one end of a BNC cable to the BNC connector J10 on the baseboard. Connect the other end of the BNC cable to an audio analyzer, amplifier, or other test equipment with an input impedance $\geq 10\text{ k}\Omega$.
3. Connect one end of a BNC cable to the BNC connector J11 on the baseboard. Connect the other end of the BNC cable to an audio analyzer, amplifier, or other test equipment with an input impedance $\geq 10\text{ k}\Omega$.
4. Make sure SW1 is set for USB POWER.
5. Connect the appropriate end of the USB cable to the USB connector J1 on the baseboard.
6. Connect the other end of the USB cable to a USB port on the PC.

6. Getting Started—Software Installation

The Si47xx Windows GUI (graphical user interface) software is designed for use with the Si4700/01/02/03 evaluation board (EVB). The GUI software revision number is available under Help→About.

The GUI software development program uses a host machine USB port to communicate with the Si47xx EVB and is tested for use with Windows XP and Windows 2000.

To install, insert the Silicon Laboratories Si47xx CD into the host machine CD drive and launch Windows Explorer. Open the CD to explore the contents in a window like the one shown in Figure 5 below.

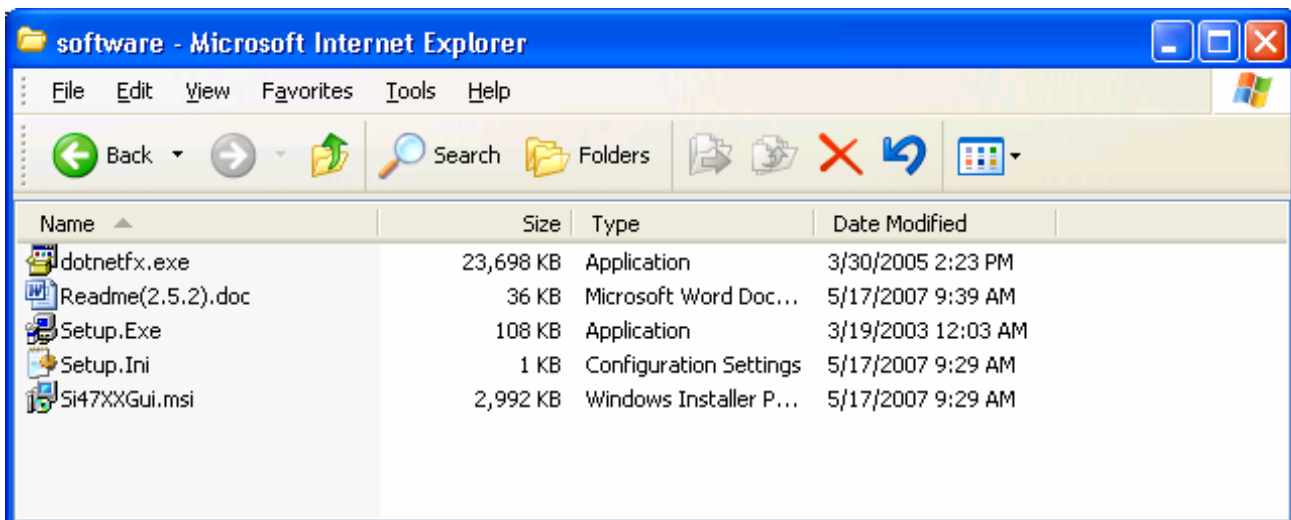

Figure 5. Installation and Setup Start Screen

Important: Open and read the Readme.doc file at this point. It may contain information that is not captured here, and which could be very important to the functionality of the EVB or software.

Run the *Setup.Exe* and follow the instructions on the screen.

Note: If you get this error message: "This setup requires the .NET Framework version 4.0," then you should install the .NET Framework that is provided on the CD and re-run the setup. The GUI requires version 4.0; however, multiple versions such as 2.0, 3.0, and 5.0 can be installed simultaneously.

After installation is finished, an Si47XXGUI icon will appear on your desktop. Launch the software by clicking this icon on the desktop as shown in Figure 6.

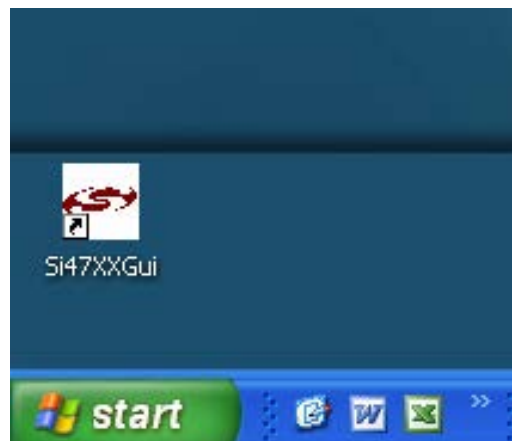

Figure 6. Launching the GUI

6.1. Connecting to the EVB

6.1.1. Initialization

The first window will show the following connect window. This window can be accessed anytime from the top menu by selecting File→Initialize.

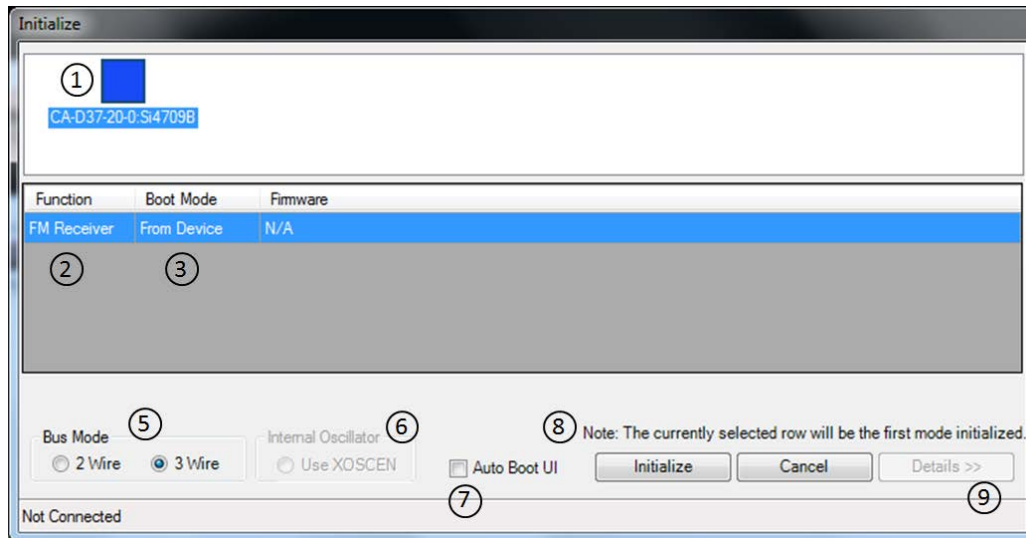

Figure 7. Initialization Screen

Table 2. Initialization Screen Explanations

#	Name	Explanation(s)
1	Connected Board List Box	If there are one or more EVBs detected, each board will be displayed with its corresponding part number and serial number. If there are no EVBs connected this list box will be empty. If your board is connected but the serial number is not displayed, Disconnect and reconnect the EVB or press the reset button on the EVB. If the drop down box is grayed out, then the software is currently connected to the board with the serial number that is displayed. To disconnect from this board, select “Cancel” and then File→Disconnect.
2	Function	For the Si4700/01/02/03 boards, this drop down selection will only allow “FM Receiver.”
3	Boot Mode	<ul style="list-style-type: none"> ■ Load Firmware from Device—will boot the chip using the firmware from NVRAM in the device. ■ Initialize Only—will perform an open and reset but will not boot the chip.
4	Reset	This option is only available if the board was previously initialized with the “Initialize Only” option. When selected, the Si470x is reset before performing the selected action. By not selecting this option, it is possible to make changes to the register map prior to enabling the device.

Table 2. Initialization Screen Explanations (Continued)

#	Name	Explanation(s)
5	Bus Mode	Selects the communication mode used to communicate with the part in either 2-Wire or 3-Wire mode.
6	Internal Oscillator	If checked then the Daughter card crystal and on-chip oscillator will be used to clock the Si4700/01/02/03. If the default is unchecked, use the baseboard oscillator. Refer to Table 1, “EVB Configuration Matrix,” on page 8 for important oscillator information. Note that the on-chip oscillator is only available on revision B silicon or later.
7	Auto Boot	If checked, the next time the GUI starts and only one EVB is connected, the initialize screen will not appear and the part will be booted automatically using the previous settings. This may be changed by selecting File→Initialize and unchecking the box.
8	Initialize/Cancel Buttons	Press Initialize to activate the chip with the selected options Press Cancel to exit.
9	Details Button	Not available with Si4700/01/02/03 parts.

6.1.2. Board Discovery Bus Mode

The initialize process can be configured to use either 2-wire or 3-wire bus mode. This can be configured by selecting File→Board Discovery Bus Mode.

This feature is useful when using the Silabs EVB and GUI to control a prototype that is designed to use one bus mode only.

6.2. Running the Software

6.2.1. FM Receiver Main Window

The FM receiver main window will appear after initialization.

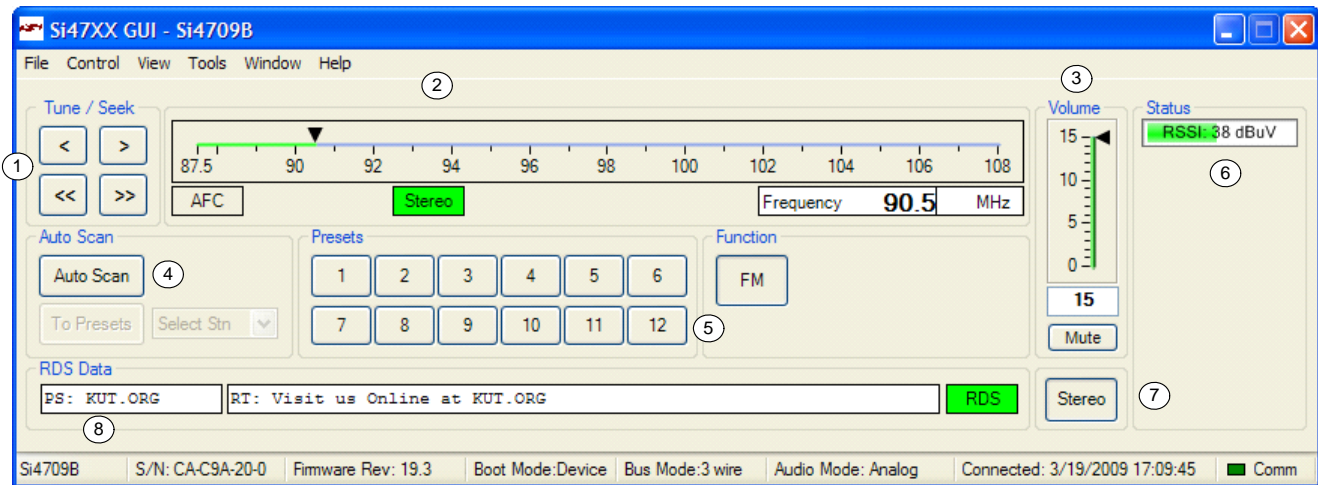

Figure 8. FM Receiver Main Window

Table 3. FM Receiver Main Window Descriptions

#	Name	Explanation(s)
1	Tune/Seek	Tune Down (<), Tune Up (>) buttons execute a single channel step according to the channel spacing setting. The channel spacing setting can be set in the property window.
		Seek Down (<<), Seek Up (>>) buttons execute a seek up or down to the next received FM signal meeting or exceeding the seek settings within the selected band. The seek setting Received Signal Strength Indicator (RSSI) threshold can be set in the property window.
2	Frequency Slider Bar, Mono/Stereo, AFC Rail	The Frequency Display indicates the frequency in MHz. To change the Frequency, drag the pointer in the Frequency Slider Bar to the desired frequency. The frequency may also be changed by changing the value in the display.
		AFC Rail indicator will be red if the tuned frequency is in an AFC rail state, otherwise the indicator will be grey.
		The Stereo / Mono Indicator is a tri-state indicator displaying "Stereo" (green), "Mono" (grey), or forced "Mono" (Yellow). The Stereo / Force Mono state can be selected by (7).
3	Volume, Mute	Select the Si4700 output volume (0-15) by moving the slider bar pointer. Press the Mute button to mute the radio. If the radio is muted, the button will be red. Press the Mute button again to remove the muting.
4	Auto Scan, To Presets, Select Stn	The Auto Scan button will find all the stations that meet the seek threshold settings in the property window.

Table 3. FM Receiver Main Window Descriptions (Continued)

#	Name	Explanation(s)
5	Presets	Press the desired button to tune to the frequency displayed on the button. To store a new value to the preset button, tune to the desired frequency and then press and hold the desired button for 1.5 seconds. The button will then change to indicate the stored frequency.
6	RSSI	The RSSI displays the received signal strength of the signal in dB μ V.
7	Mono/Stereo Select Button	By default, the receiver is configured for stereo mode. To force mono, click the button. To return to stereo mode, click the button again.
8	RDS Data (PT/RT/RDS Indicator)	Provides a summary of the current RDS data if available. PS contains the Program Service text, RT contains the Radio Text, and the RDS indicator turns green when RDS data has been synchronized. For more RDS data select Window→RDS Receive Data.

6.2.2. FM Receiver RDS Window

The FM Receive RDS window allows the user to view program service, program type, PI code, radio text, clock, group error rate, sync and display times, an alternate frequency list, and group statistics. Select Window→RDS Receive Data.

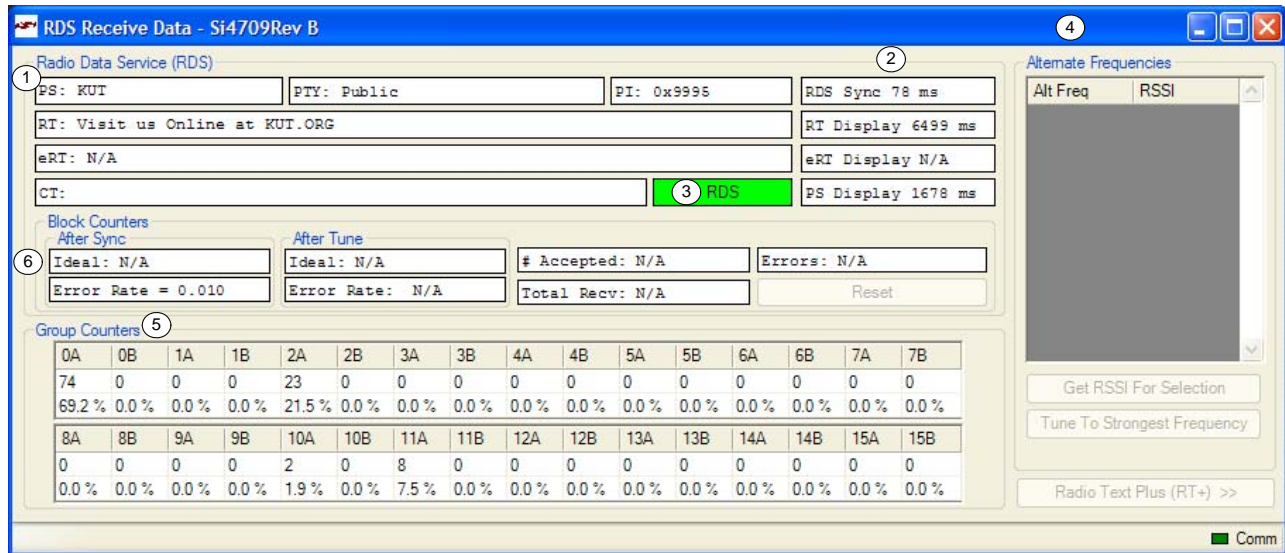

Figure 9. FM Receiver Settings RDS Window

Table 4. FM Receiver Settings RDS Window Descriptions

#	Name	Explanation(s)
1	Radio Data Service	PS: Program Service Indicator (8 characters).
		RT: Radio Text Indicator (64 characters).
		CT: Clock Indicator showing time, day, and date
		PTY: Program Type Indicator
		PI: PI Code Indicator
2	Sync Times	Time required to synchronize, display radio text, and display program service.
3	RDS Synchronization Indicator	Indicates that RDS is synchronized.
4	Alternate Frequency Indicator	When present, shows a list of alternate frequencies.
5	Group Counters	Provides the total number and percentage breakdown of group types 0–15, A / B. To view this information, select Window→RDS Group Counters. Please refer to Figure 54.
6	Block Counters	Provides the block error rates after tune and after RDS sync.

Table 4. FM Receiver Settings RDS Window Descriptions (Continued)

#	Name	Explanation(s)
		<p>After Tune Error Rate: After tune (STC interrupt), the ideal number of blocks the FM tuner should have received is calculated. Also, the number of accepted blocks and errors are calculated. For Si4700/01/02/03 parts, the ideal number is not available in the UI.</p> <p>Error Rate = number of errors / number of ideal blocks after tune.</p>

6.2.3. RDS Group Counters

This screen allows you to view the RDS Group Data in detail. This screen is accessed from the RDS Group Counters option in the Window menu.

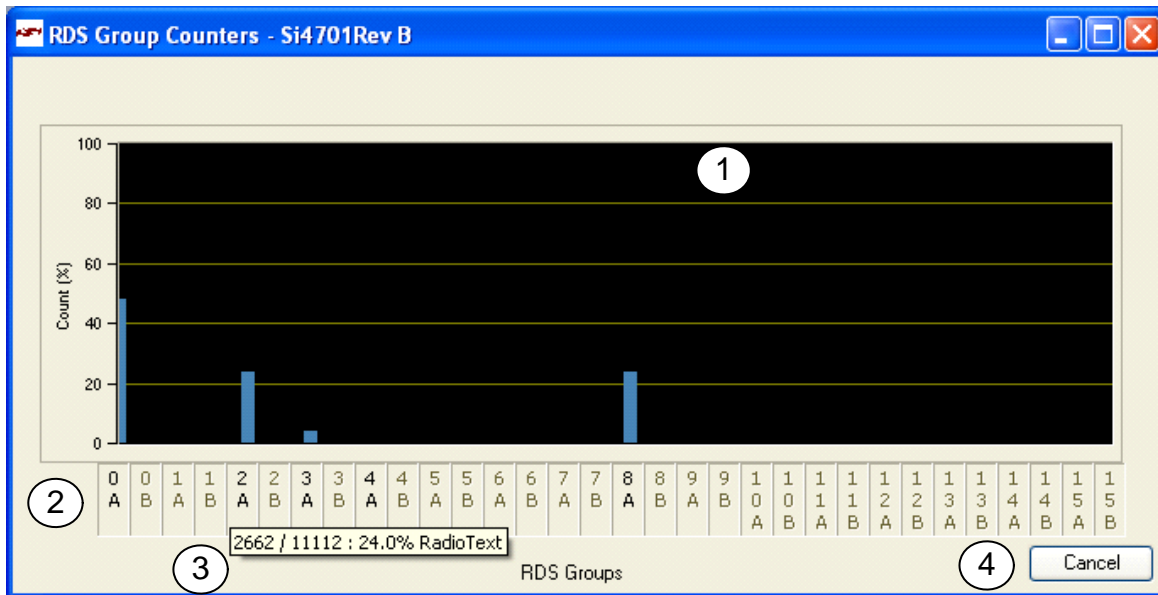

Figure 10. RDS Group Counters Window

Table 5. RDS Group Counters Window Explanations

#	Name	Explanation(s)
1	Histogram	A histogram of all the RDS Group counters displayed for the tuned station. The RDS statistics begin accumulating once a new station has been tuned.
2	RDS Group Labels	RDS group labels (e.g., 0A, 0B, 1A, etc.) If there has been RDS data for that particular group (e.g., 2A), then the label will be displayed in Bold type. If there has not been RDS data for the group, then the label will be in light type indicating no data for that group.
3	Tooltips	By moving your mouse over a group label, the number of counts / total count and percentage and group designation will be displayed.
4	Cancel	Press Cancel to close the window.

6.2.4. RSSI Graph Screen

The RSSI Graph Window allows the user to plot RSSI across the FM band. Bitmap data can be saved to file by selecting File→Save as Bitmap and tabulated data can be saved to file by selecting File→Save to .csv. This window can be accessed by selecting Window→RSSI Graph.

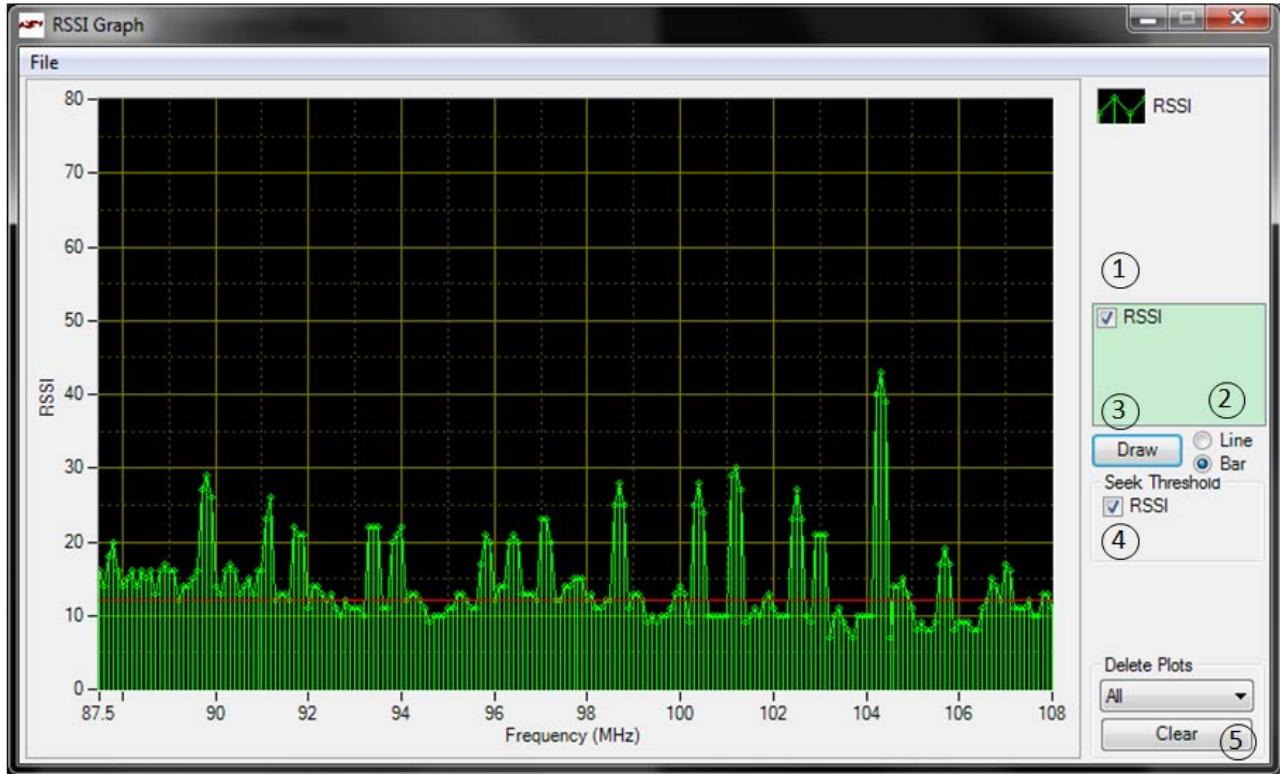

Figure 11. FM Receiver RSSI Graph Window

Table 6. FM Receiver RSSI Graph Window Descriptions

#	Name	Explanation(s)
1	RSSI Graph	Indicates RSSI graph will be drawn.
2	Line / Bar	Select between drawing in bar mode (depicted as green) or in continuous line mode (depicted as yellow).
3	Draw	Click this to start plotting the graph.
4	Seek Threshold (RSSI)	Draw the RSSI seek threshold as specified in the properties. The RSSI seek threshold is shown in red.
5	Delete Plots	Select the desired plot to delete in the drop down control and then click Clear to delete that plot.

6.2.5. Register Map Display

This screen displays the settings of the register map as detailed in the Si4700/01 or Si4702/03 data sheets. This display is accessed by selecting Window→Register Map.

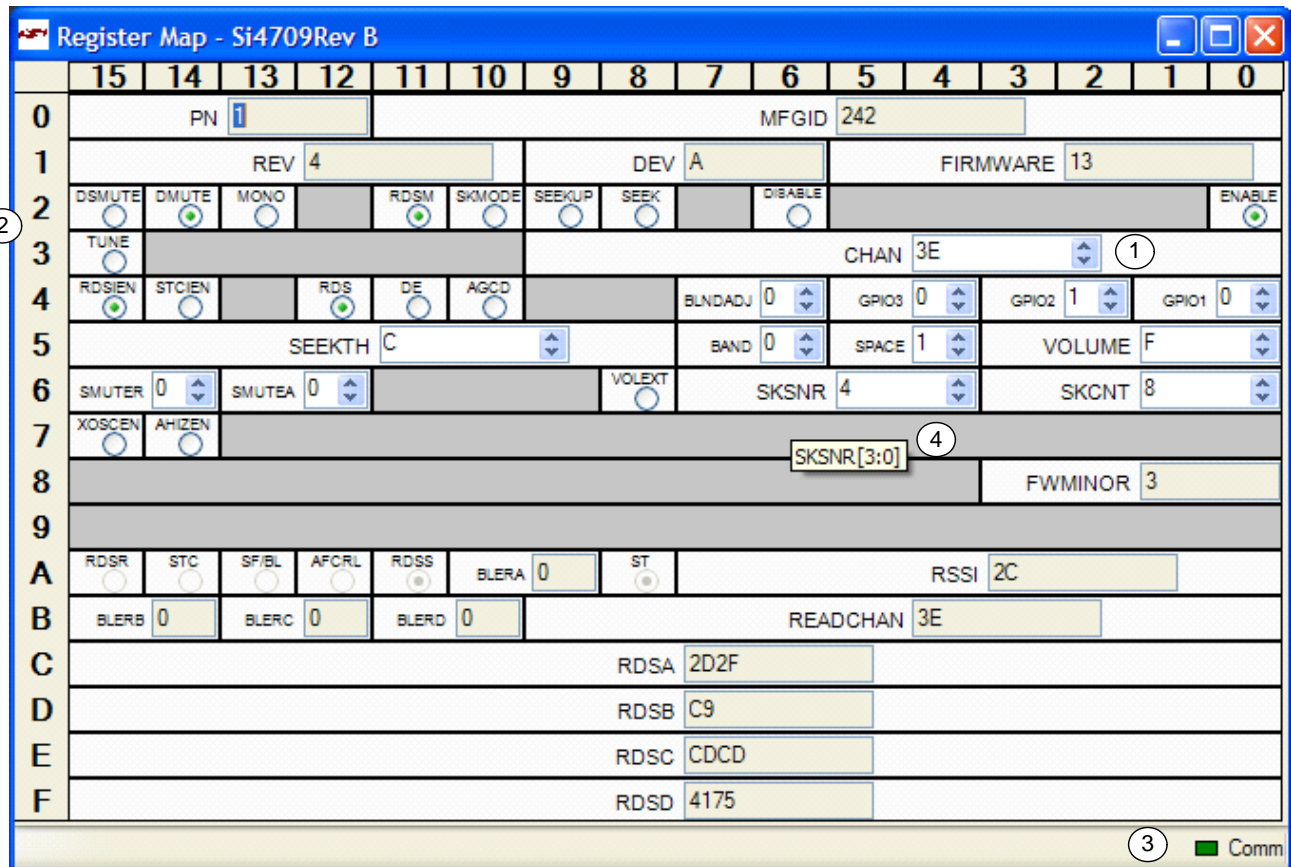

Figure 12. Register Map Window

Table 7. Register Map Window Explanations

#	Name	Explanation(s)
1	Multiple-bit Fields	Multiple-bit fields can be changed by clicking the up or down arrows or by typing the value directly. The setting will be written to the chip when the value is changed.
2	Single-bit Fields	Single-bit fields can be changed between 1 and 0 by clicking the radio button on and off, respectively. The setting will be written to the chip when the value is changed.
3	Communication LED	The register map is updated whenever the Updating LED is green. The update time is selectable from the View→Session Preferences menu. Updates may be disabled by checking or unchecking Control→Update.
4	Tooltips	Moving the cursor over the register number will give the register name as a tooltip. Moving over each numeric field label will give the bit range as a tooltip.

6.2.6. Log Band Scan

Selecting Tools→Log Band Scan allows you to specify a filename and begin a scan of the entire band for RDS data, RDS acquisition times, and the contents of each register. The scan feature starts with the first frequency in the band (CHAN = 0) and then seeks to the first station that meets the seek criteria (SEEKTH, SKCNT, SKSNR).

When a valid station is found, the software waits at the station for the time specified by View→Session Preferences→Scan Log After Tune Delay (sec) and then checks if RDS is available. If RDS is not available, the software logs the register settings and seeks to the next valid station. If RDS is available, the software waits an additional delay as specified by View→Session Preferences→Scan Log RDS Log Delay (sec). When this delay expires, the software logs the RDS information and register settings and seeks to the next valid station. While scanning, the software displays a green "Scanning" notice below the menu bar. The scan can be aborted by selecting the Tools→Log Band Scan a second time. When the scan completes, the filename given is saved in comma separated format and is available for analysis in a text editor or spreadsheet.

6.2.7. Log Raw RDS Data

Selecting Tools→Log Raw RDS Data prompts for a filename in which all RDS data will be logged in comma separated format. The software then logs all raw RDS data that is received, the station it is received on, and the time at which it was received. The logging will continue until Tools→Log Raw RDS Data is selected a second time at which point the file is saved and available for analysis in a text editor or spreadsheet.

6.2.8. Log Channel Info

Selecting Tools→Log Channel Info prompts for a filename in which all register values will be logged in comma separated format. The software then logs all register values and the time at which it was received. The logging will continue until Tools→Log Channel Info is selected a second time, at which point the file is saved and available for analysis in a text editor or spreadsheet.

6.2.9. Log Device Commands

Selecting Tools→Log Device Commands prompts for a filename in which all software API calls and data with timestamp data will be logged as text. The logging will continue until Tools→Log Device Commands is selected a second time, at which point the file is saved and available for analysis in a text editor.

6.2.10. Startup Preferences Dialog

The startup Preferences Dialog is accessed via the top menu View→Startup Preferences. It enables you to customize standard settings for your local needs. All startup preferences are saved in the user.ini file.

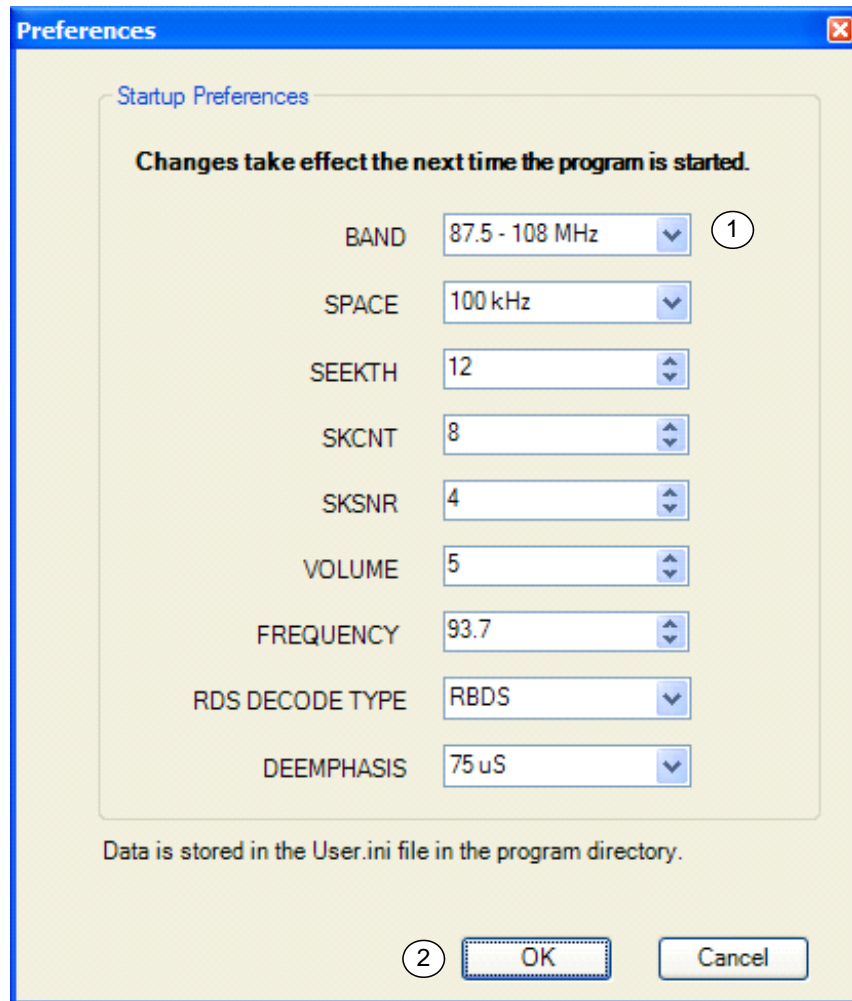

Figure 13. Startup Preferences

Table 8. Startup Preferences Explanations

#	Name	Explanation
1	Default Radio Settings	Select the Radio Parameters that you want loaded each time you start the application. Refer to Table 10, "GUI Properties," on page 24 for an explanation of each property.
2	OK/Cancel	Press OK to save the values, press Cancel to exit without saving. This data is stored in the file User.ini in your application directory.

6.2.11. Session Preferences Dialog

The session Preferences Dialog is accessed via the top menu View→Session Preferences. It enables you to adjust settings that will take effect immediately. The settings will also be used the next time you start the application. All session preferences are saved in the user.ini file.

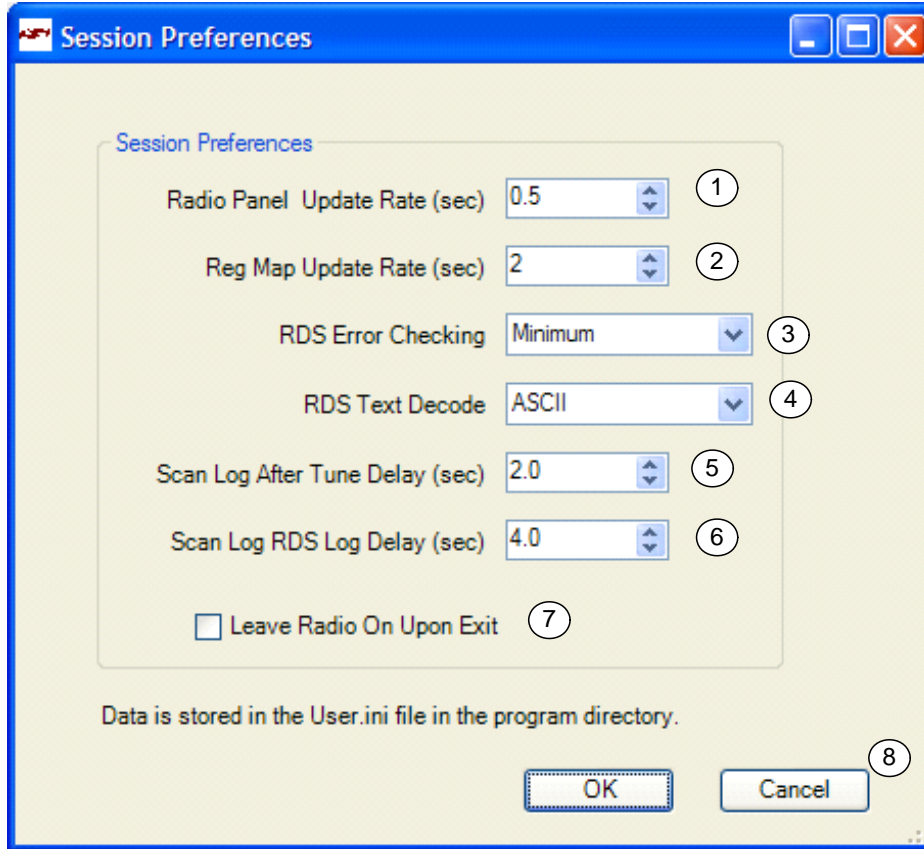

Figure 14. Session Preferences

Table 9. Session Preferences Explanations

#	Name	Explanation(s)
1	Radio Panel Update Rate	Select the update rate for the radio panel tab. The default is 0.5 seconds.
2	Reg Map Update Rate	Select the update rate for the register map tab and property grid. This value must be greater than the GUI Update rate or you will get an error.
3	RDS Error Checking	Select the default method for RDS error checking performed on the baseboard. For more description, see RDS Error Checking in Table 10.
4	RDS Text Decode	Select the default character set for displaying RDS data.
5	Scan Log After Tune Delay	Select how many seconds the Tools → Log Band Scan feature waits to determine if the found channel has RDS. If the channel has RDS, then the RDS Log Delay applies, otherwise it seeks to the next channel.
6	Scan Log RDS Log Delay	Select how many seconds are allowed during a Tools → Log Band Scan to gather RDS data, RT time, and PS time. This timer begins when the “After Tune Delay” expires.

Table 9. Session Preferences Explanations (Continued)

#	Name	Explanation(s)
7	Leave Radio On Upon Exit	Check this box if you want to leave the radio playing when you exit the application, otherwise it will turn off.
8	OK/Cancel	Press OK to save the changes, cancel to exit without saving.

6.2.12. Help About Screen

This screen displays important information regarding version information of the application, EVB, and chip firmware.

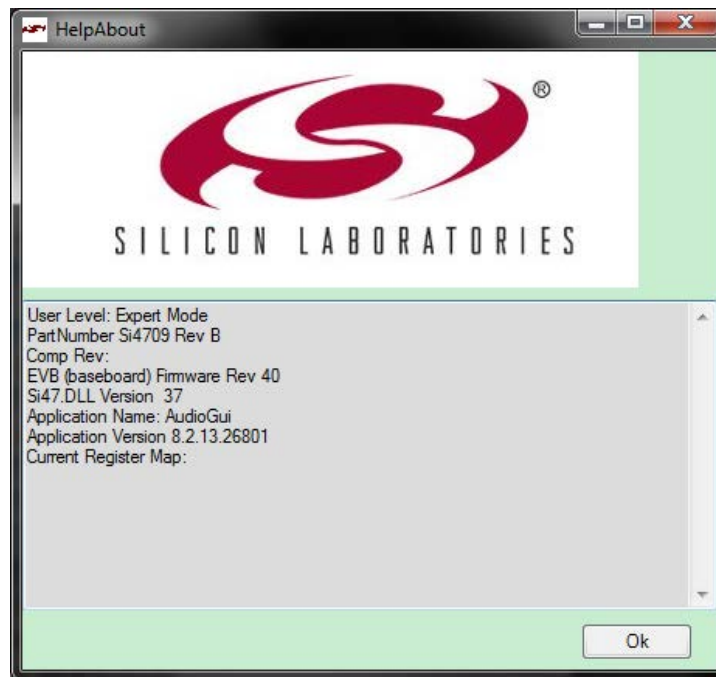

Figure 15. Help About Screen

Table 10. GUI Properties

Property	Description	Settings
Frequently Used		
BAND	Select the band of frequencies	US/Europe, 0 = 87.5 – 108 MHz Japan Wide, 1 = 76–108 MHz Japan Normal 2 = 76–90 MHz
MONO	Mono Select	0 = Stereo 1 = Force Mono
PTYDECODE	RDS Type	0 = RDS decoding 1 = RBDS decoding
SEEKTH	Select the RSSI threshold to use when seeking manually or automatically.	0–70 RSSI value in dB μ V
SKCNT	Seek Impulse Noise Count	0–7 (See data sheet)
SKSNR	Seek Signal to Noise Ratio	0–15 (See data sheet)
SPACE	Select the spacing between tunable frequencies.	0 = 200 kHz (US), 1 = 100 kHz (Europe/Japan) 2 = 50 kHz,
Seek/Tune		
AFCRL	AFC Rail	0 = AFC Not Railed 1 = AFC Railed
CHAN	Channel Select	See data sheet
READCHAN	Read Channel	See data sheet
SEEK	Seek Enable	0 = Disable 1 = Enable
SEEKTH	Select the RSSI threshold to use when seeking manually or automatically.	0–70 RSSI value in dB μ V
SEEKUP	Seek Direction	0 = Seek Down 1 = Seek Up
SF/BL	Seek Fail/Band Limit	0 = Seek Successful 1 = Seek Fail / Band Limit Reached
SKCNT	Seek Impulse Noise Count	0–15 (See data sheet)
SKMODE	Seek Mode	0 = Wrap at band Limits 1 = Stop at band limits
SKSNR	Seek Signal to Noise Ratio	0–7 (See data sheet)
ST	Stereo Indicator	0 = Mono 1 = Stereo
STC	Seek/Tune Complete - Set when the seek or tune operation completes.	0 = Complete 1 = Not Complete

Table 10. GUI Properties (Continued)

Property	Description	Settings
STCIEN	Seek/Tune Complete Interrupt Enable - when this feature is enabled, all activity on the SDIO pin is stopped during seek and tune so there is no update of the seek progress.	0 = Disable Interrupt 1 = Enable Interrupt
TUNE	Tune	0 = Disable 1 = Enable
Audio Control		
BLNDADJ	Stereo/Mono Blend Level Adjustment	00 = 31–49 dB μ V 01 = 37–55 dB μ V 10 = 19–37 dB μ V 11 = 25–43 dB μ V
DE	De-emphasis	0 = 75 μ S 1 = 50 μ S
DMUTE	Mute	0 = Mute Disable 1 = Mute Enable
DSMUTE	Softmute	0 = Softmute Enable 1 = Softmute Disable
SMUTEA	Softmute Attenuation	00 = 16 dB 01 = 14 dB 10 = 12 dB 11 = 10 dB
SMUTER	Softmute Rate	00 = fastest 01 = fast 10 = slow 11 = slowest
VOLEXT	Volume Extend	0 = Volume table dynamic range is 28 dBFs. 1 = Expands volume table dynamic range to 58 dBFs. See AN281 for more details.
VOLUME	Volume	0(mute)–15(max)
Misc Status		
DEV	Device ID	Read only
FIRMWARE	Firmware Version	Read only
MFGID	Manufacturer ID (hex)	Read only 0x242
PN	Chip Part Number	1 = Si4700/01/02/03 (Read only)
REV	Chip Hardware Revision	Read only
Misc Control		
AGCD	Automatic Gain Control	0 = AGC Enable 1 = AGC Disable
AHIZEN	Analog Output Hi-Z Enable	0 = Hi-Z Disable 1 = Hi-Z Enable

Table 10. GUI Properties (Continued)

Property	Description	Settings
DISABLE	Powerup Disable	0 = Not active 1 = Initiate Powerdown
ENABLE	Powerup Enable	0 = Not active 1 = Initiate Powerup
GPIO1 General Purpose I/O 1	General Purpose I/O 1	00 = High Impedance 01 = Reserved 10 = Low 11 = High
GPIO2 General Purpose I/O 2	General Purpose I/O 2	00 = High Impedance 01 = STC/RDS Interrupt 10 = Low 11 = High
GPIO3 General Purpose I/O 3	General Purpose I/O 3	00 = High Impedance 01 = Mono/Stereo Indicator 10 = Low 11 = High
XOSCEN	Crystal Oscillator Enable - this setting must be selected on the Initialize screen.	0 = External Clock 1 = On-chip Oscillator
RDS Status		
BLERA	RDS Block A Error Count	00 = 0 errors 01 = 1–2 errors 10 = 3–5 errors 11 = 6+ errors
BLERB	RDS Block B Error Count	00 = 0 errors 01 = 1–2 errors 10 = 3–5 errors 11 = 6+ errors
BLERC	RDS Block C Error Count	00 = 0 errors 01 = 1–2 errors 10 = 3–5 errors 11 = 6+ errors
BLERD	RDS Block D Error Count	00 = 0 errors 01 = 1–2 errors 10 = 3–5 errors 11 = 6+ errors
RDSR	RDS Ready	0 = No RDS Ready 1 = New RDS Ready
RDSS	RDS Synchronized	0 = RDS not synchronized 1 = RDS synchronized
RDS Control		
RDS	RDS Enable	0 = Disable 1 = Enable

Table 10. GUI Properties (Continued)

Property	Description	Settings
RDS ERROR CHECKING	RDS Error Checking	Three options are available: <ul style="list-style-type: none"> • Minimum - displays the RDS data exactly as it is received from the Si4701/03. • Mid-level - RDS data is verified by comparing the current byte with the previous bytes received from the Si4701/03. Only consistent data is displayed. If the A/B flag toggles, the data is displayed regardless of verification status. Data is more error free than the minimum setting, but some errors may be displayed on stations using the A/B flag improperly. • Maximum - RDS data is verified as in the mid-level setting, but the A/B flag is ignored. Data is virtually error free, but may take longer to display.
RDS Text Decoding	RDS Text Decoding Mode	ASCII Big 5 (Traditional Chinese) Default (Use system code page) UTF-8 Unicode
RDSIEN	RDS Interrupt Enable	0 = Disable interrupt 1 = Enable interrupt
RDSM	RDS Verbose Mode	0 = Standard 1 = Verbose
EVb MCU		
Headphone Amp	Turns on and off the headphone amplifier	0 = Off 1 = On

7. Schematics

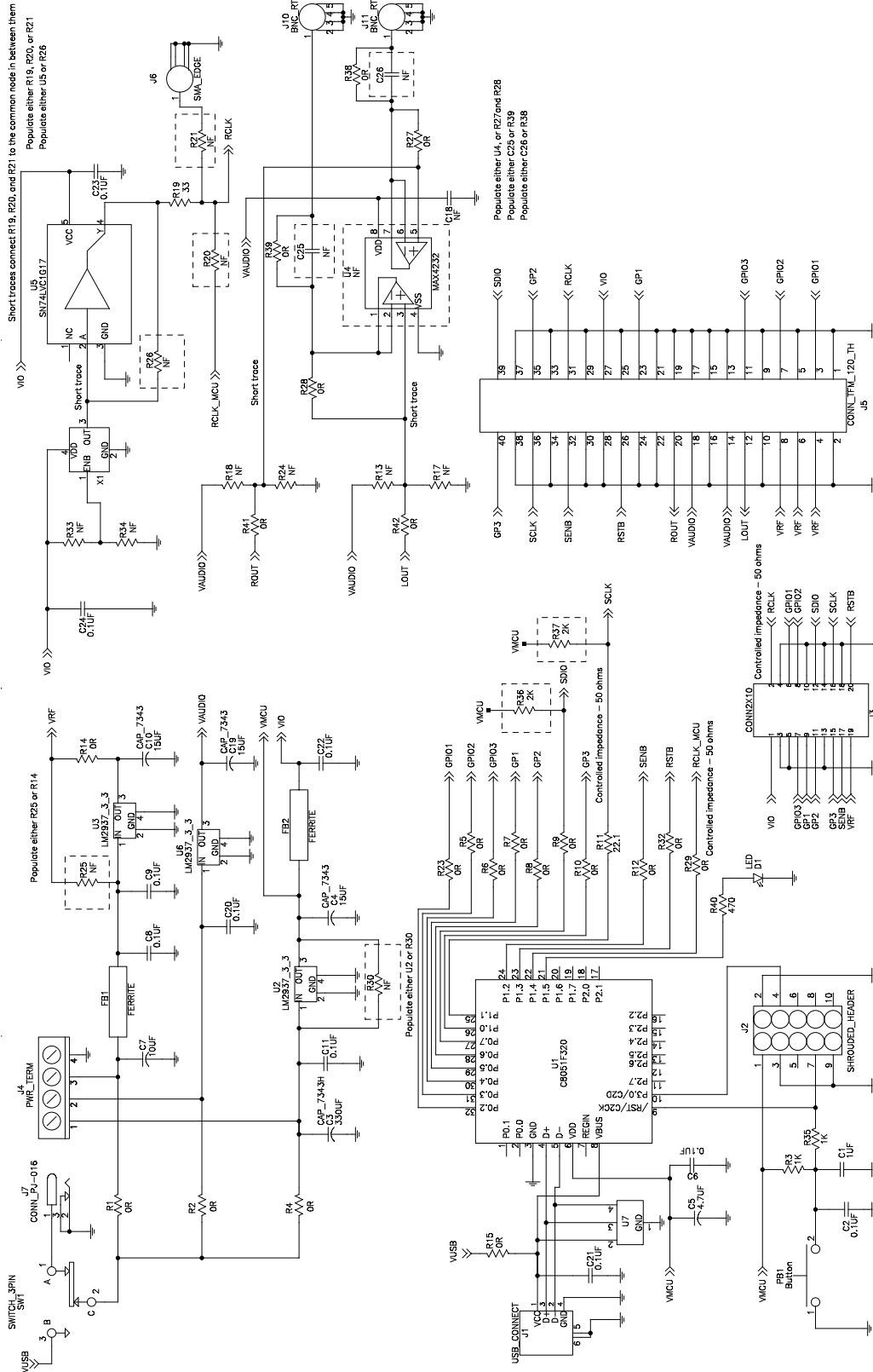

Figure 16. Si4700 Baseboard

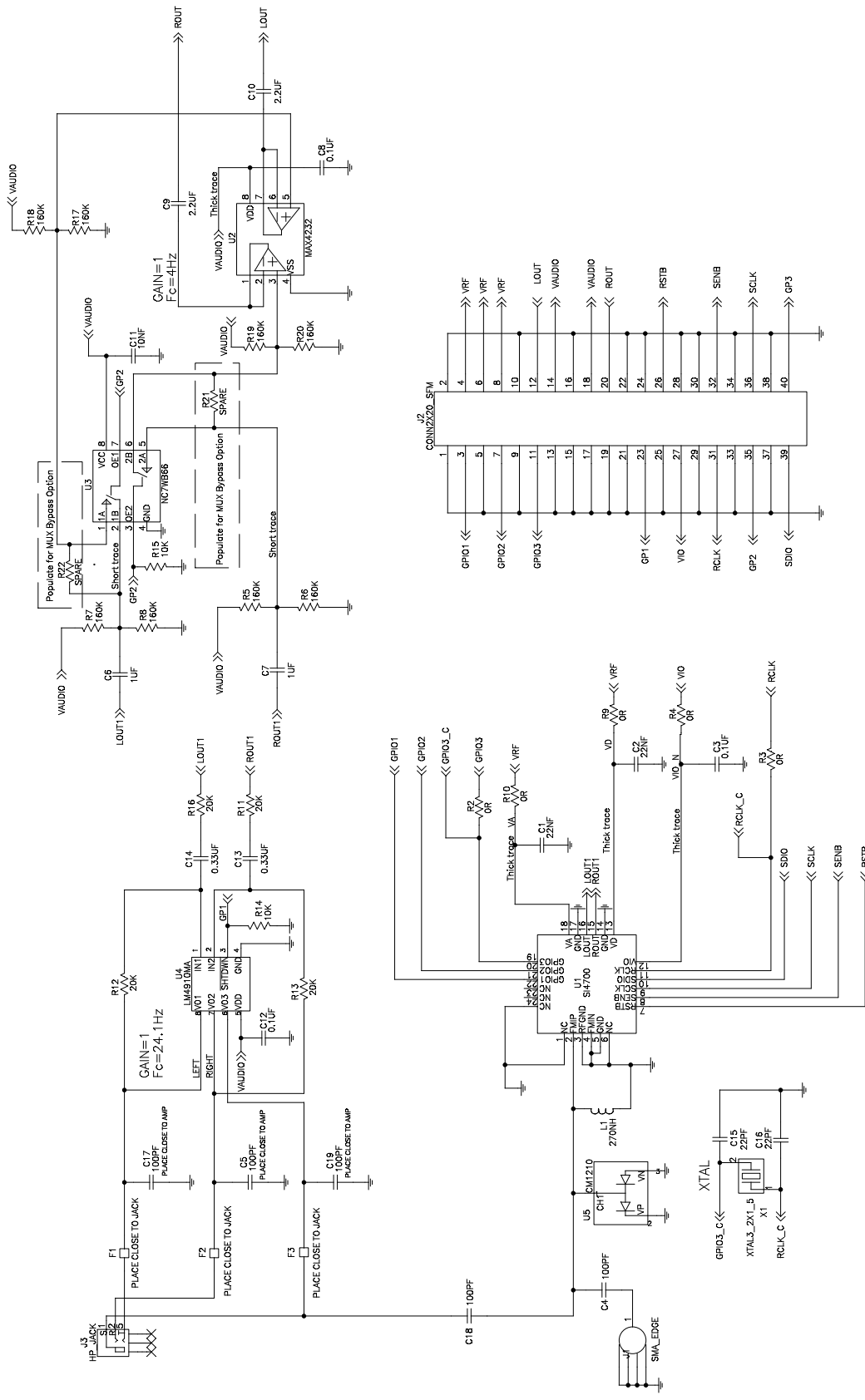

Figure 17. Si4700/01 Daughter Card

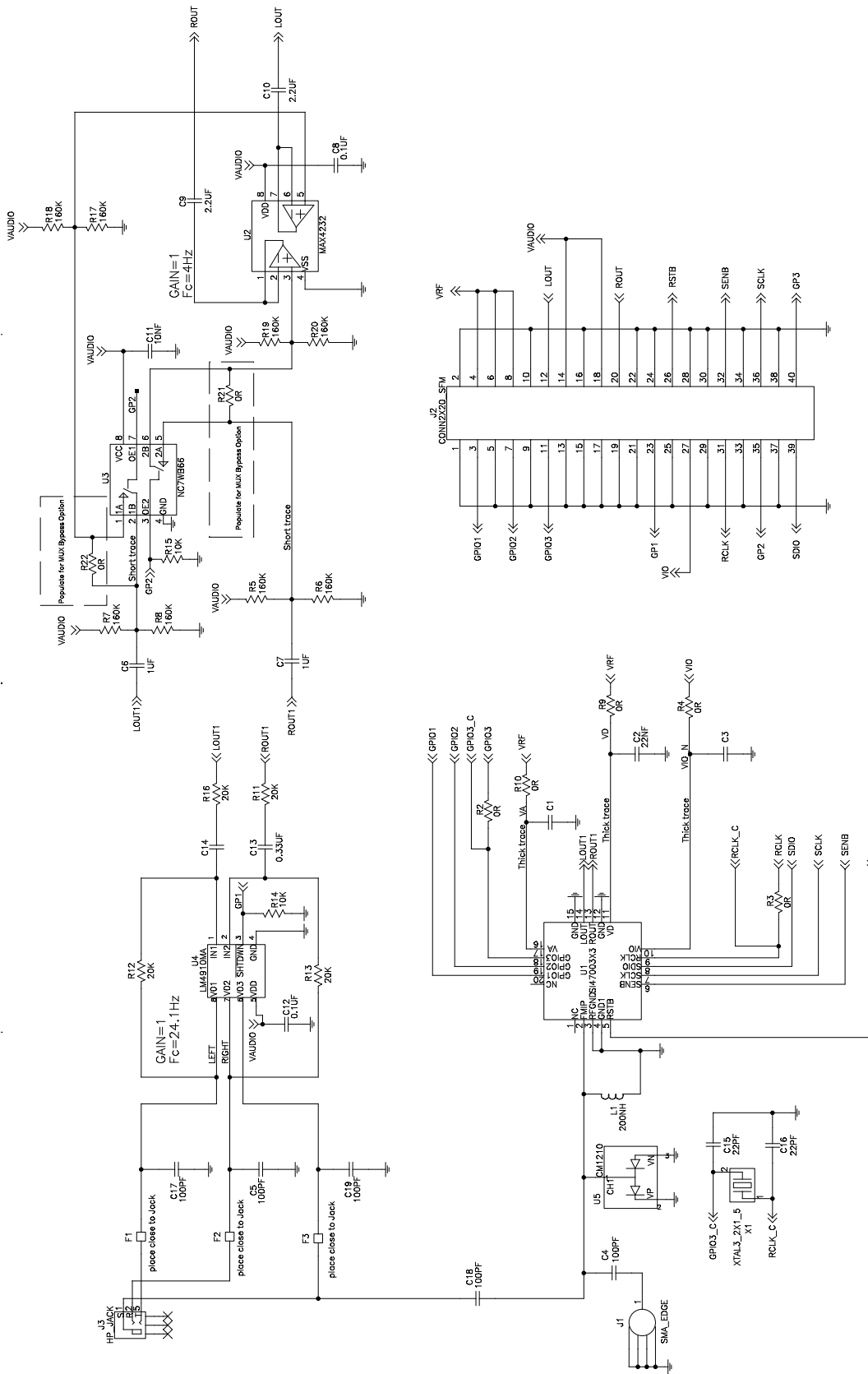

Figure 18. Si4702/03 Daughter Card

8. Layout

8.1. Baseboard

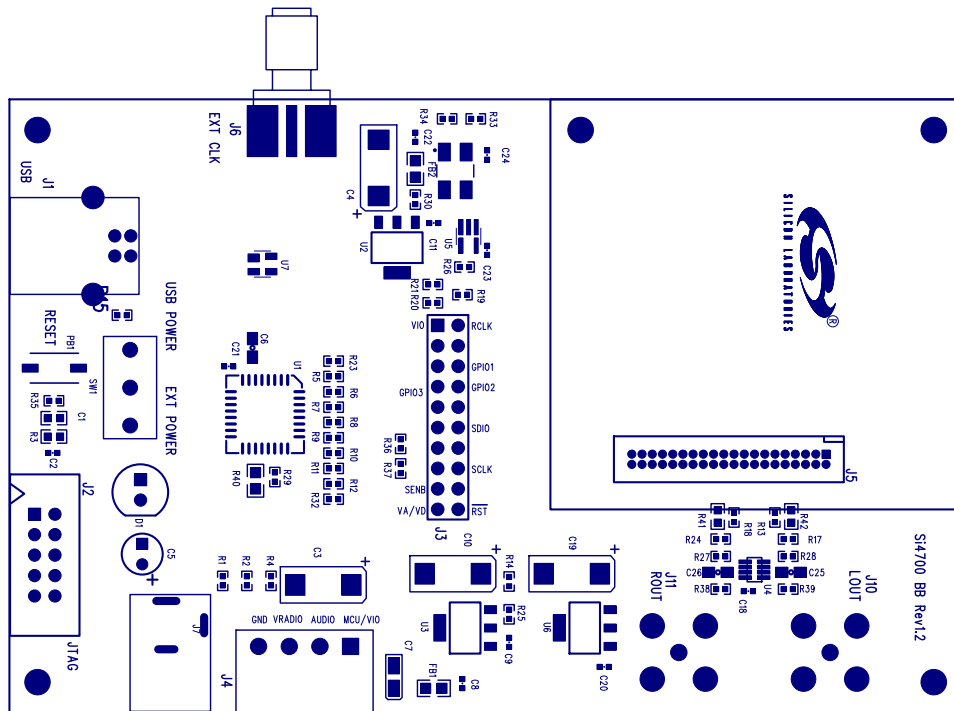

Figure 19. Baseboard—Primary Assembly Silkscreen

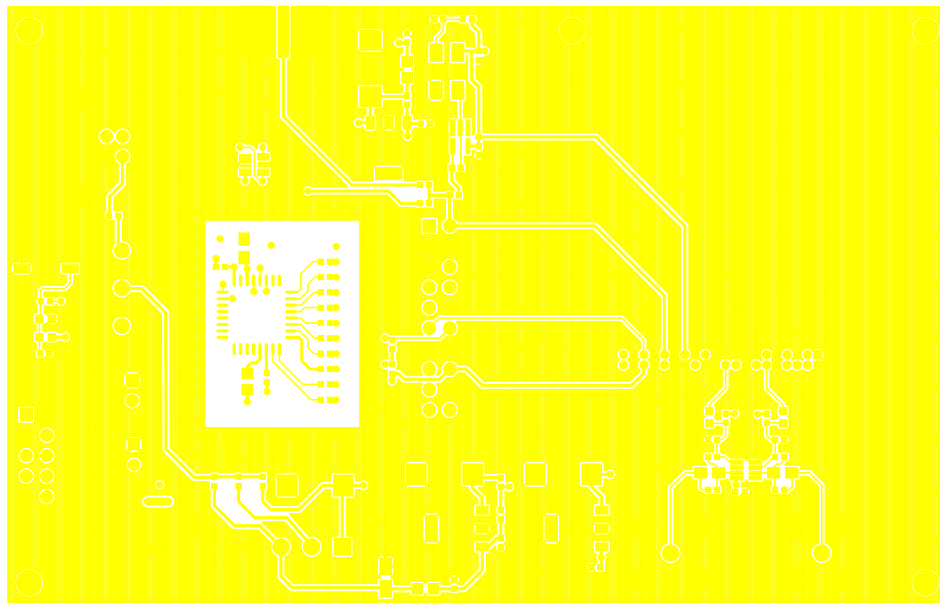

Figure 20. Baseboard—Primary Side

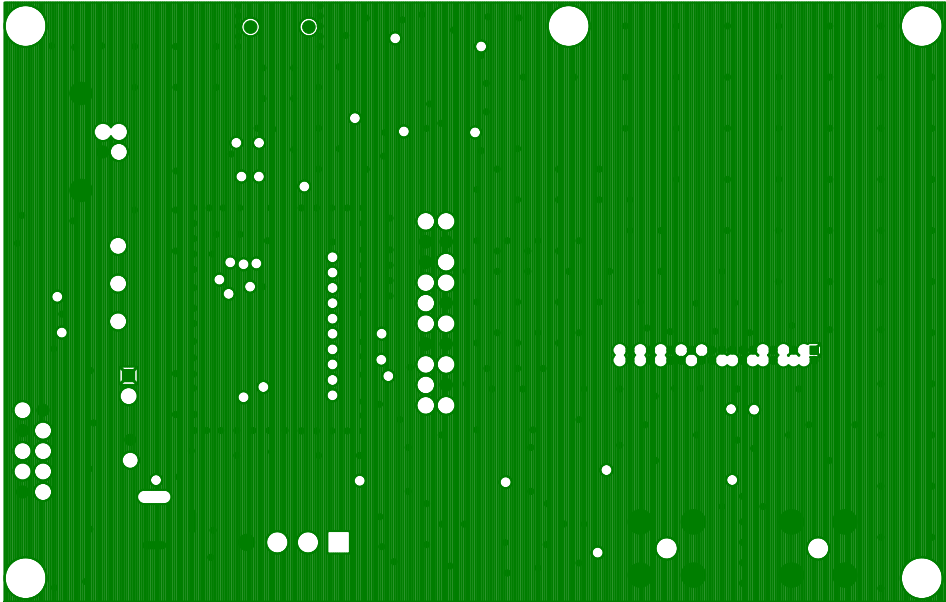

Figure 21. Baseboard—Ground Plane

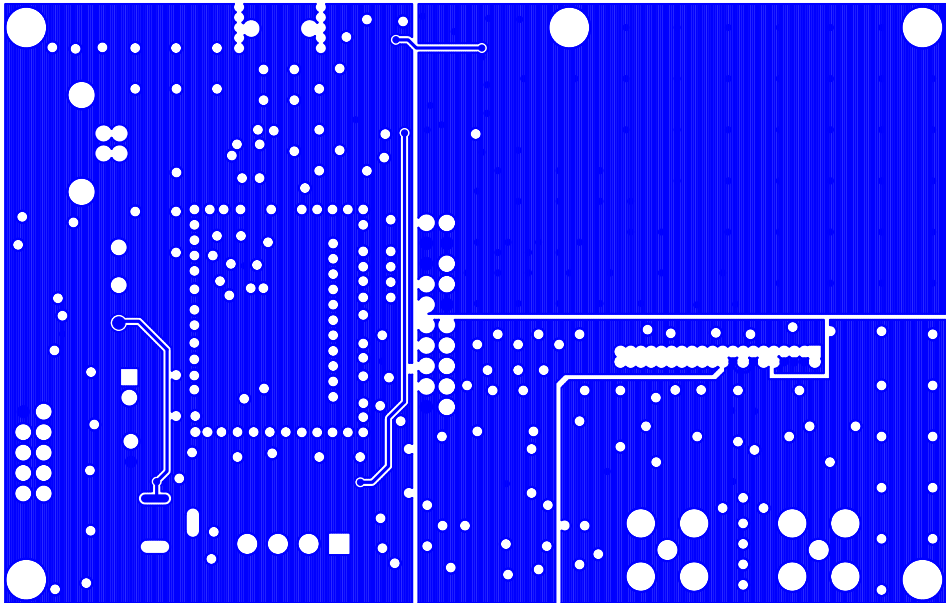

Figure 22. Baseboard—Power Plane

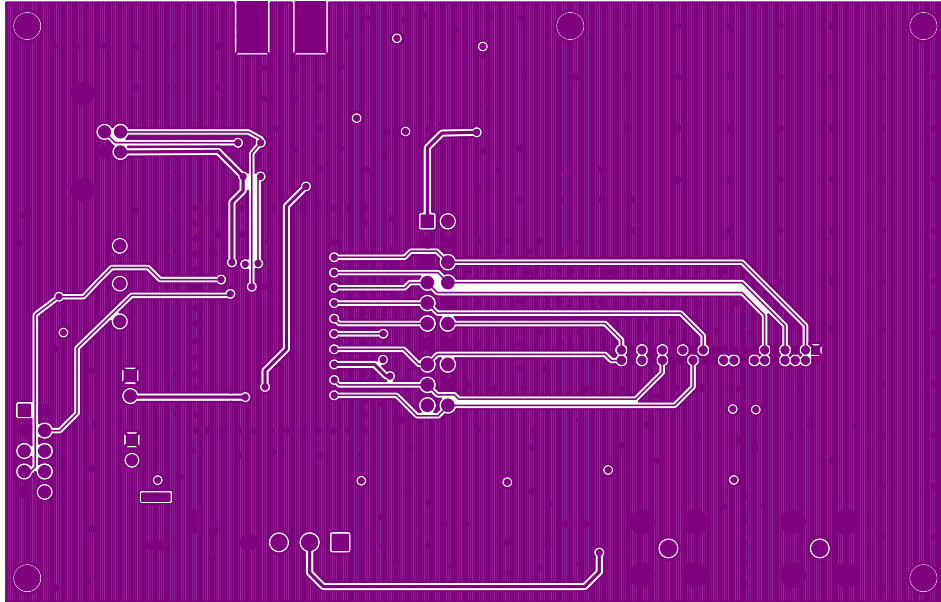

Figure 23. Baseboard—Secondary Side

Si4700/01/02/03-EVB

8.2. Si4700/01 Daughter Card

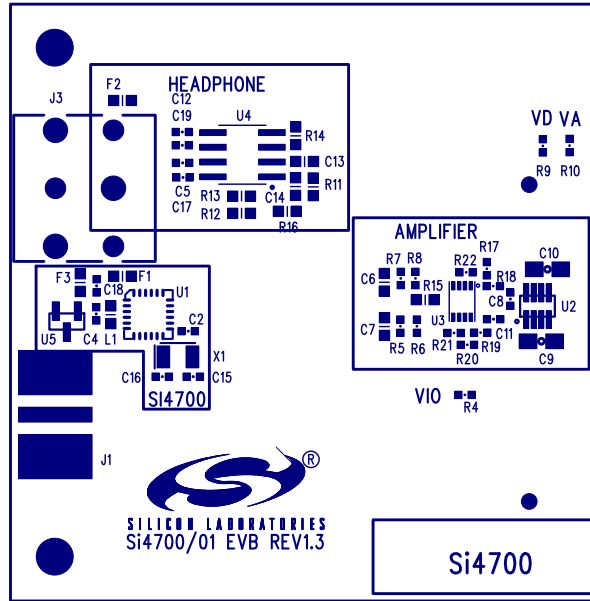

Figure 24. Si4700/01 Daughter Card—Primary Assembly Silkscreen

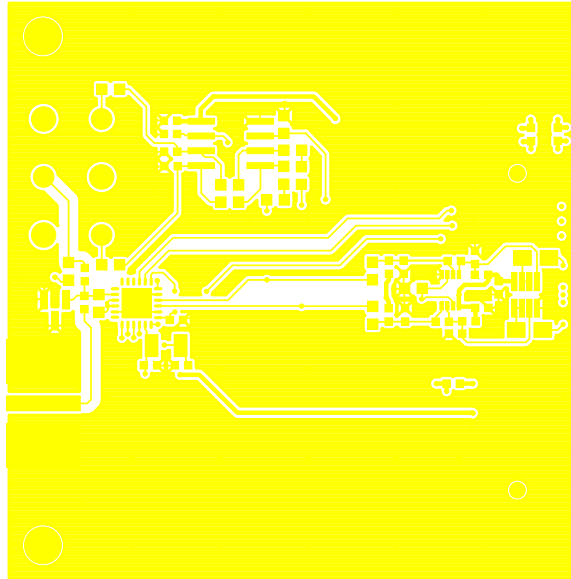

Figure 25. Si4700/01 Daughter Card—Primary Side

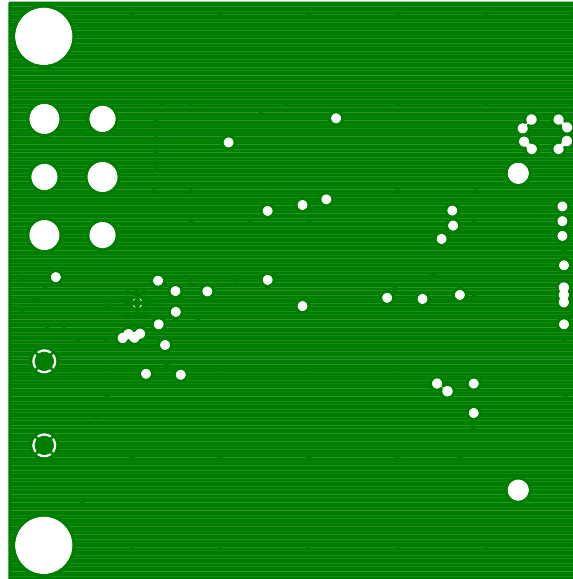

Figure 26. Si4700/01 Daughter Card—Ground Plane

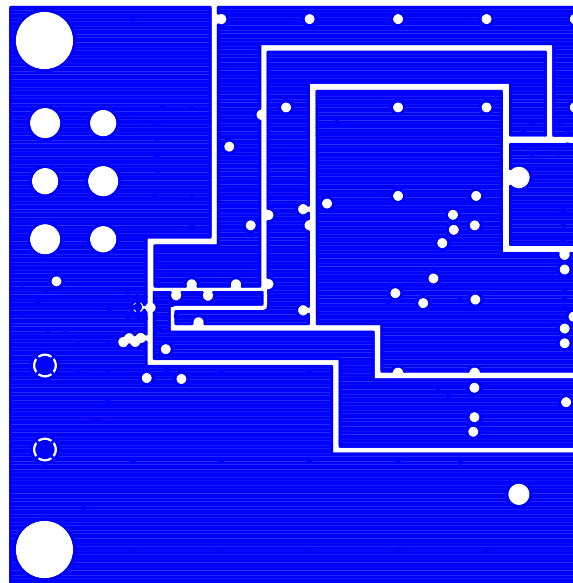

Figure 27. Si4700/01 Daughter Card—Power Plane

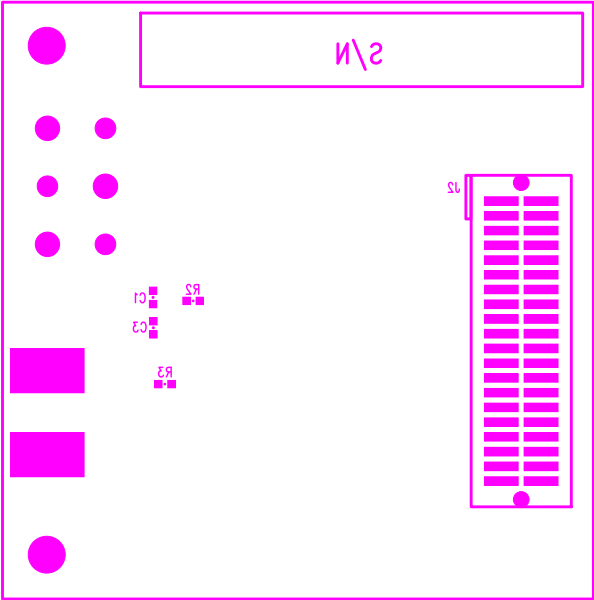

Figure 28. Si4700/01 Daughter Card—Secondary Assembly Silkscreen

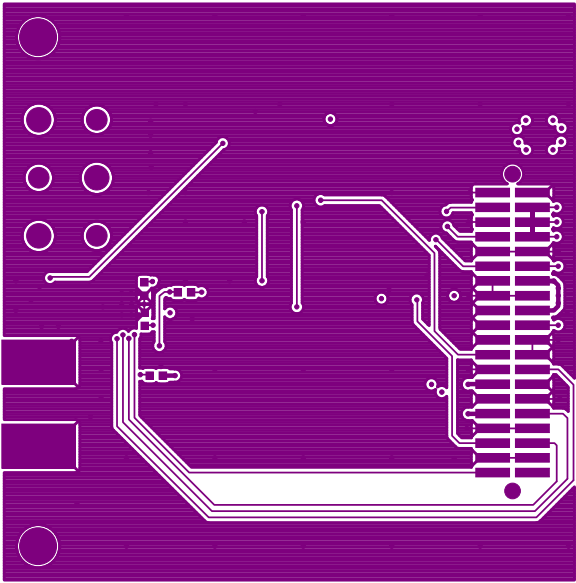

Figure 29. Si4700/01 Daughter Card—Secondary Side

8.3. Si4702/03 Daughter Card

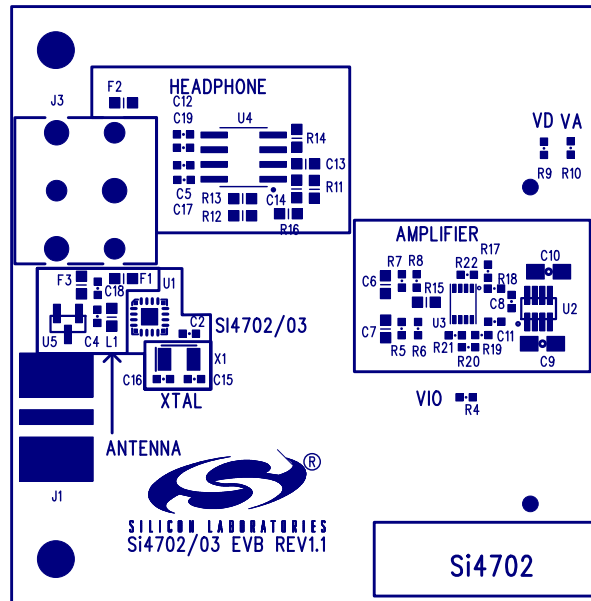

Figure 30. Si4702/03 Daughter Card—Primary Assembly Silkscreen

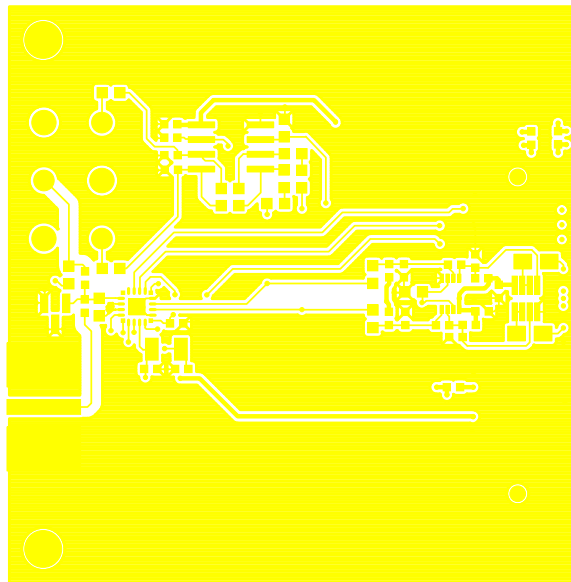

Figure 31. Si4702/03 Daughter Card—Primary Side

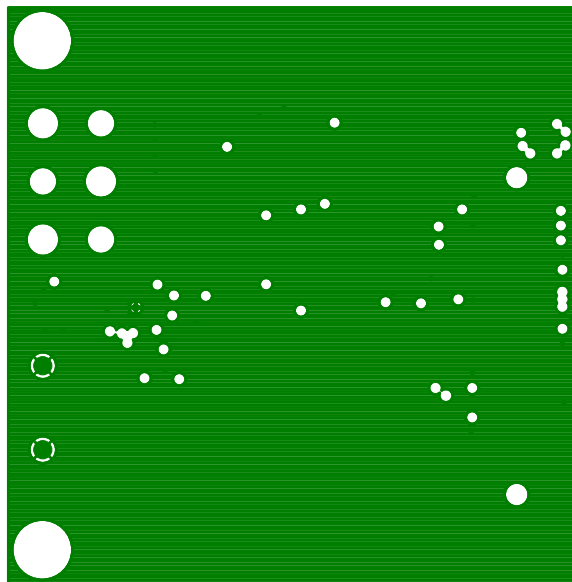

Figure 32. Si4702/03 Daughter Card—Ground Plane

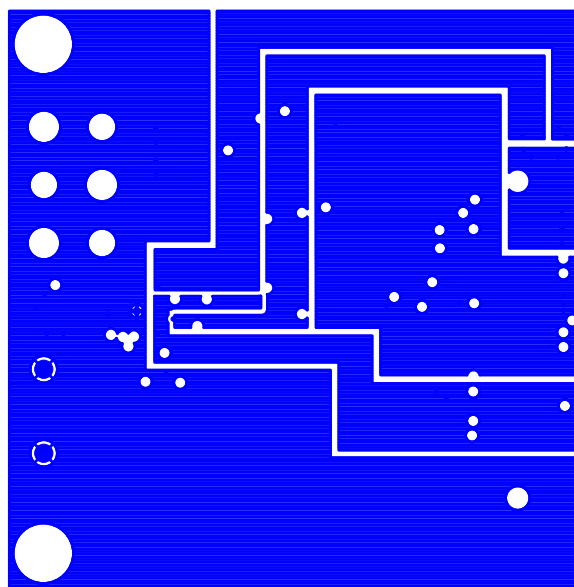

Figure 33. Si4702/03 Daughter Card—Power Plane

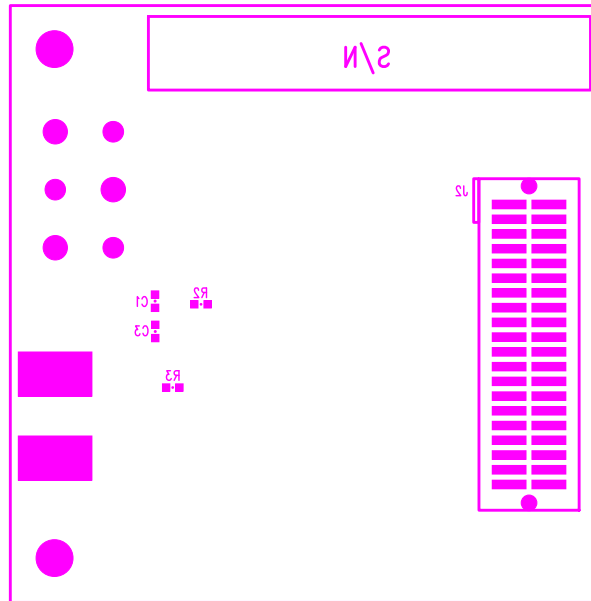

Figure 34. Si4702/03 Daughter Card—Secondary Assembly Silkscreen

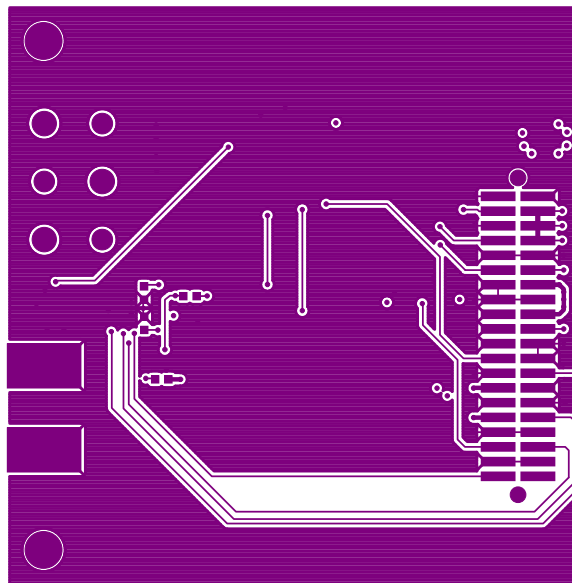

Figure 35. Si4702/03 Daughter Card—Secondary Side

Si4700/01/02/03-EVB

9. Bill of Materials

9.1. Bill of Materials—Baseboard

Table 11. Bill of Materials—Baseboard

ITEM	QTY	REFDES	DESCRIPTION	VALUE	FOOTPRINT	MFG/Vendor	Part number
1	1	C1.	CAP,SM,0603,1UF,X7R	1 UF	RC0603	VENKEL	C0603X7R100-105KNE
2	3	C10,C19,C4	CAP,SM,7343,15UF,10%	15UF	7343_EIAD	VISHAY	PCT15/20DK
3	9	C11,C2,C20,C21,C22,C23,C24,C8,C9	CAP,SM,0402,0.1UF,10%	0.1 UF	CC0402	VENKEL	C0402X7R160-104KNE
4	1	C18	CAP,SM,0402,0.1UF,10%	NF	CC0402	VENKEL	C0402X7R160-104KNE
5	2	C25,C26	CAP,SM,0805	NF	C0805	VENKEL	C0805X7R100-225KNE
7	1	C5	CAP,TANT,RADIAL	4.7UF		KEMET	TB4.7/16K1
8	1	C6	CAP,0.1UF,X7R,0805,50V,5%	0.1UF	C0805	Venkel	NMC0805X7R104K50TRP
9	1	C7	CAP,SM,3216	10UF	3216_EIAA	VISHAY	PCT10/16AK
10	1	D1	LED, T-1 3/4 RED DIFFUSED			LITEON	LTL-10223W
11	2	FB1,FB2	FERRITE BEAD,SM		RC0805	Steward	MI0805K400R-00
12	1	J1	CONN,TH,USB,RCPT,TYPE B		CONN-USB-B	Kycon	KUSB-BS-1-N-BLK
13	2	J10,J11	CONN,BNC,TH,RIGHT ANGLE,COAXIAL,NICKEL-PLATED		CONN-BNC_RT	AMP	413631-3
14	1	J2	HEADER,SHROUDED,5X2		CONN2X5_SHROUDED	3M	2510-6002UB
15	1	J3	CONN,TH,2X10,HDR		CONN2X10	SAMTEC	TSW-110-07-G-D
16	1	J4	PCB TERMINAL BLOCK, 4 POSITION			PHOENIX CONTACT	1803293
17	1	J5	CONN,TH,TFM,HDR,2X20,0.05X0.05IN PITCH		CONN40-TFM-T/H	SAMTEC	TFM-120-01-S-D
18	1	J6	CONN, SMA, EDGEMOUNT		SMA-EDGE-5	Y-Connect	RA2EJ26G
19	1	PB1	BUTTON,SM,LIGHT-TOUCH,160GF,6X3.5MM		EVQPPBA25	PANASONIC	EVQ-PPBA25
20	15	R1,R2,R4,R10,R12,R14,R15,R23,R27,R28,R29,R32,R38,R39,R5,R6,R7,R8,R9	RES,SM,0402	0R	RC0402	VENKEL	CR0402-16W-000T
21	1	R11	RES,SM,0402,1%	22.1	RC0402	VENKEL	CR0402-16W-22R1FT
22	4	R13,R17,R18,R24	RES,SM,0402,160,5%	NF	RC0402	Venkel	CR0402-16W-164JT
23	1	R19	RES,SM,0402,1%	33	RC0402	VENKEL	MCR01MZPF33R0
24	2	R20,R21	RES,SM,0402	NF	RC0402	?	
26	5	R25,R26,R30,R33,R34	RES,SM,0402	NF	RC0402		
27	1	R3	RES,SM,0603	1K	RC0603	VENKEL	CR0603-10W-1001FT
28	1	R35	RES,SM,0402	1K	RC0402	VENKEL	CR0402-16W-102J
29	2	R36,R37	RES,SM,0402	2K	RC0402	VENKEL	CR0402-16W-202JT
30	1	R40	RES,SM,0805	470	RC0805	VENKEL	CR0805-8W-471JT
31	2	R41,R42	RES,SM,0603	0R	RC0603	VENKEL	CR0603-10W-000T
32	1	U1	IC,SM,C8051F320.MCU,LQFP-32,9X9MM	LQFP-32-LD	SILICON LABORATORIES	C8051F320/1	
33	3	U2,U3,U6	VOLTAGE_REG,3_3 V,500MA,SOT223		SOT223	NATIONAL SEMICONDUCTOR	LM2937IMP-3.3
34	1	U4		NF	SOT23-8N	MAXIM	
35	1	U5	IC,SINGLE SCHNITT TRIGGER BUFFER		SOT23-5	TI	SN74LVC1G17DBVR

Table 11. Bill of Materials—Baseboard (Continued)

ITEM	QTY	REFDES	DESCRIPTION	VALUE	FOOTPRINT	MFG/Vendor	Part number
36	1	U7			SOT143	LITTLEFUSE	SP0503BAHT
37	1	X1	32_768KHZ,OSC,SM		OSCILLATOR	ECS	ECS-327SMO-TR
38	1	01	Shield,SM			LeaderTech	20S-CBSF-0.75X1.0X0.2
39	4	02	Nylon Stand-offs			Eagle Plastic Devices	TSP3
40	4	03	Nylon Screws			Eagle Plastic Devices	P440.375
41	1	05	Pluggable Terminal Header			PHOENIX CONTACT	1803594
42	2	06	Nylon Stand-offs			Eagle Plastic Devices	13SP040
43	2	7	Nylon Screws			Eagle Plastic Devices	P440.75
44	1	SW1	2 throw 3 pole switch		3pin_switch	E-switch	500ssp1s1m2rea
45	1	J7	2.1 mm power connector		PJ-002A	CUI	PJ-002A

9.2. Bill of Materials—Si4700/01 Daughter Card

Table 12. Bill of Materials—Si4700/01 Daughter Card

ITEM	QTY	Side	REFDES	DESCRIPTION	VALUE	FOOTPRINT	MFG/Vendor	MFG/Vendor_PN
1	1	Top	C2	CAP,SM,0402,X7R	22NF	CC0402	MURATA	GRM155R71E223KA61D
1	1	Bottom	C1	CAP,SM,0402,X7R	22NF	CC0402	MURATA	GRM155R71E223KA61D
2	2	Top	C10,C9	CAP,SM,0805	2.2UF	C0805	VENKEL	C0805X7R100-225KNE
3	1	Top	C11	CAP,SM,0402,X7R	10NF	CC0402	MURATA	GRM155R71E103KA01D
4	2	Top	C8,C12	CAP,SM,0402,X7R	0.1UF	CC0402	MURATA	GRM155R71C104KA88D
4	1	Bottom	C3	CAP,SM,0402,X7R	0.1UF	CC0402	MURATA	GRM155R71C104KA88D
5	2	Top	C13,C14	CAP,SM,0603,0.33UF,X7R	0.33UF	RC0603	VENKEL	C0603X7R160-334KNE
6	5	Top	C4,C5,C17,C18,C19	CAP,SM,0402,X7R	100PF	CC0402	MURATA	GRM1555C1H101JZ01D
7	2	Top	C15,C16	CAP,SM,0402	22PF	CC0402	VENKEL	C0402C0G500-220JNE
9	2	Top	C6,C7	CAP,SM,0603,1UF,X7R	1UF	RC0603	VENKEL	C0603X7R100-105KNE
10	1	Top	J1	SMA,EDGE-MOUNT,GOLD PLATED		SMA-EDGE-5	YAZAKI	RA2EJ2-6G
11	1	Top	J2	CONN,SM,2X20,SFM		CONN-2X20-SFM	SAMTEC	SFM-120-02-S-D-A
12	1	Top	J3	CONN,AUDIO JACK,3.5MM,STEREO		SJ3543N	DIGIKEY	CP-3543N-ND
13	3	Top	F1,F2,F3	Ferrite Bead,SM,0603	2500ohm	FB0603	MURATA	BLM18BD252SN1D
14	1	Top	L1	Ind,0603,SM	270nH	IND0603	MURATA	LQW18ANR27J00D
16	3	Top	R10,R4,R9	RES,SM,0402	0R	RC0402	VENKEL	CR0402-16W-000T
17	2	Bottom	R2,R3	RES,SM,0402	0R	RC0402	VENKEL	CR0402-16W-000T
18	4	Top	R11,R12,R13,R16	RES,SM,0603	20K	RC0603	VENKEL	CR0603-16W-203JB
19	2	Top	R14,R15	RES,SM,0603	10K	RC0603	VENKEL	CR0603-16W-103JT
20	8	Top	R17,R18,R19,R20,R5,R6,R7,R8	RES,SM,0402,160K,5%	160K	RC0402	VENKEL	CR0402-16W-164JT
21	1	Top	U1	IC,SM,Si4700,MLP24		MLP24-4MM	SILICON LABORATORIES	SI4700

Si4700/01/02/03-EVB

Table 12. Bill of Materials—Si4700/01 Daughter Card (Continued)

ITEM	QTY	Side	REFDES	DESCRIPTION	VALUE	FOOTPRINT	MFG/Vendor	MFG/Vendor_PN
22	1	Top	U2	IC,SM,AUDIO AMP,SOT23-8		SOT23-8N	MAXIM	MAX4232AKA+T
23	1	Top	U3	IC,SM,UHS DUAL SPST,8 LEAD US8		US8	FAIRCHILD SEMI-CONDUCTOR	FSA266K8X
24	1	Top	U4	IC,SM,HEADPHONE AMP		M08A	NATIONAL SEMI-CONDUCTOR	LM4910MA
25	1	Top	U5	IC,SM,ESD PROTECTION DIODE,SOT23-3		SOT23-3N	CALIFORNIA MICRO DEVICES	CM1210-01ST
26	1	Top	X1	OSC,SM,Crystal 32.768KHz,Chip	32.768KH Z		Epson	FC-135

9.3. Bill of Materials—Si4702/03 Daughter Card

Table 13. Bill of Materials—Si4702/03 Daughter Card

ITEM	QTY	REFDES	DESCRIPTION	VALUE	FOOTPRINT	MFG/Vendor	MFG/Vendor_PN
1	2	C1,C2	CAP,SM,0402,X7R	22 NF	CC0402	MURATA	GRM155R71E223KA61D
2	2	C10,C9	CAP,SM,0805	2.2 UF	C0805	VENKEL	C0805X7R100-225KNE
3	1	C11	CAP,SM,0402,X7R	10 NF	CC0402	MURATA	GRM155R71E103KA01D
4	3	C8,C12,C3	CAP,SM,0402,X7R	0.1 UF	CC0402	MURATA	GRM155R71C104KA88D
5	2	C13,C14	CAP,SM,0603,0.33UF,X7R	0.33 UF	RC0603	VENKEL	C0603X7R160-334KNE
7	2	C15,C16	CAP,SM,0402	24 PF	CC0402	VENKEL	C0402C0G500-240JNE
8	5	C4,C5,C17,C18,C19	CAP,SM,0402,C0G,5%	100 PF	CC0402	MURATA	GRM1555C1H101JZ01D
9	2	C6,C7	CAP,SM,0603,1UF,X7R	1 UF	RC0603	VENKEL	C0603X7R100-105KNE
10	1	J1	SMA,EDGE-MOUNT,GOLD PLATED		SMA-EDGE-5	YAZAKI	RA2EJ2-6G
11	1	J2	CONN,SM,2X20,SFM		CONN-2X20-SFM	SAMTEC	SFM-120-02-S-D-A
12	1	J3	CONN,AUDIO JACK,3.5MM,STEREO		SJ3543N	DIGIKEY	CP-3543N-ND
13	1	L1	IND,SM,0603	270 NH	IND0603	MURATA	LQW18ANR27J00D
14	3	F1,F2,F3	Ferrite Bead,SM,0603	2500 ohm	FB0603	MURATA	BLM18BD252SN1D
15	5	R10,R4,R9,R2,R3	RES,SM,0402	0R	RC0402	VENKEL	CR0402-16W-000T
16	4	R11,R12,R13,R16	RES,SM,0603	20 K	RC0603	VENKEL	CR0603-16W-203JB
17	2	R14,R15	RES,SM,0603	10 K	RC0603	VENKEL	CR0603-16W-103JT
18	8	R17,R18,R19,R20,R5, R6,R7,R8	RES,SM,0402,160K,5%	160 K	RC0402	VENKEL	CR0402-16W-164JT
19	1	U1	IC,SM,SI4700,MLP20		MLP20-3MM	SILICON LABORATORIES	SI4700
20	1	U2	IC,SM,AUDIO AMP,SOT23-8		SOT23-8N	MAXIM	MAX4232AKA+T
21	1	U3	IC,SM,UHS DUAL SPST,8 LEAD US8		US8	FAIRCHILD SEMICONDUCTOR	FSA266K8X
22	1	U4	IC,SM,HEADPHONE AMP		M08A	NATIONAL SEMICONDUCTOR	LM4910MA
23	1	U5	IC,SM,ESD PROTECTION DIODE,SOT23-3		SOT23-3N	CALIFORNIA MICRO DEVICES	CM1210-01ST
24	1	X1	OSC,SM,Crystal 32.768KHz,Chip	32.768 KHz		Epson	FC-135

DOCUMENT CHANGE LIST

Revision 0.4 to Revision 0.5

- Added support for Si4702/03 evaluation boards.

Revision 0.5 to Revision 0.6

- Updated for GUI version 1.5.
- Additional RDS error checking mode added.
- RDS acquisition timers added.
- Updated for firmware revision 16.
- RDSPRF and VOLEXT added to Table 10, "GUI Properties," on page 24.

Revision 0.6 to Revision 0.7

- Updated for GUI version 3.4.4.

Revision 0.7 to Revision 0.8

- Updated for GUI version 4.0.7.

Revision 0.8 to Revision 0.9

- Updated for GUI version 8.2.13.



Smart.
Connected.
Energy-Friendly.



Products
www.silabs.com/products



Quality
www.silabs.com/quality



Support and Community
community.silabs.com

Disclaimer

Silicon Labs intends to provide customers with the latest, accurate, and in-depth documentation of all peripherals and modules available for system and software implementers using or intending to use the Silicon Labs products. Characterization data, available modules and peripherals, memory sizes and memory addresses refer to each specific device, and "Typical" parameters provided can and do vary in different applications. Application examples described herein are for illustrative purposes only. Silicon Labs reserves the right to make changes without further notice to the product information, specifications, and descriptions herein, and does not give warranties as to the accuracy or completeness of the included information. Without prior notification, Silicon Labs may update product firmware during the manufacturing process for security or reliability reasons. Such changes will not alter the specifications or the performance of the product. Silicon Labs shall have no liability for the consequences of use of the information supplied in this document. This document does not imply or expressly grant any license to design or fabricate any integrated circuits. The products are not designed or authorized to be used within any FDA Class III devices, applications for which FDA premarket approval is required or Life Support Systems without the specific written consent of Silicon Labs. A "Life Support System" is any product or system intended to support or sustain life and/or health, which, if it fails, can be reasonably expected to result in significant personal injury or death. Silicon Labs products are not designed or authorized for military applications. Silicon Labs products shall under no circumstances be used in weapons of mass destruction including (but not limited to) nuclear, biological or chemical weapons, or missiles capable of delivering such weapons. Silicon Labs disclaims all express and implied warranties and shall not be responsible or liable for any injuries or damages related to use of a Silicon Labs product in such unauthorized applications.

Trademark Information

Silicon Laboratories Inc.®, Silicon Laboratories®, Silicon Labs®, SiLabs® and the Silicon Labs logo®, Bluegiga®, Bluegiga Logo®, ClockBuilder®, CMEMS®, DSPLL®, EFM®, EFM32®, EFR, Ember®, Energy Micro, Energy Micro logo and combinations thereof, "the world's most energy friendly microcontrollers", Ember®, EZLink®, EZRadio®, EZRadioPRO®, Gecko®, Gecko OS, Gecko OS Studio, ISOModem®, Precision32®, ProSLIC®, Simplicity Studio®, SiPHY®, Telegesis, the Telegesis Logo®, USBXpress®, Zentri, the Zentri logo and Zentri DMS, Z-Wave®, and others are trademarks or registered trademarks of Silicon Labs. ARM, CORTEX, Cortex-M3 and THUMB are trademarks or registered trademarks of ARM Holdings. Keil is a registered trademark of ARM Limited. Wi-Fi is a registered trademark of the Wi-Fi Alliance. All other products or brand names mentioned herein are trademarks of their respective holders.



Silicon Laboratories Inc.
400 West Cesar Chavez
Austin, TX 78701
USA

<http://www.silabs.com>