



EV2667-G-00A

Evaluation Board of 1A Linear Charger with Power Path Management for Single-Cell Li-Ion Battery in QFN Package

DESCRIPTION

The EV2667-G-00A is an evaluation board for the MP2667, a highly-integrated single-cell Li-Ion/Li-Polymer battery charger with system power path management, targeted at space limited portable applications. It takes input power from either an AC adapter or a USB port to supply the system load and charge the battery independently. The charger section features constant current pre charge (PRE.C), constant current fast charge (CC), constant voltage (CV) regulation, charge termination, and charge status.

EV2667 ensures the continuous power to the system by automatically selecting the input, the battery or both to power the system.

EV2667 provides system short circuit protection to prevent the Li-Ion battery from being damaged due to excessive high current.

EV2667 cuts off the path between battery and system when battery UVLO to prevent the Li-Ion battery from being overly discharged.

Through the I2C connector on EV2667, the customer can program the charging parameters, such as: input current limit, input minimum voltage regulation, charging current, battery regulation voltage, and battery UVLO.

ELECTRICAL SPECIFICATION

Parameter	Symbol	Value	Units
Input Voltage	V_{IN}	4.35 - 5.5	V
Battery Voltage	V_{BATT}	3.60 - 4.545	V
Input Current Limit	I_{IN_LIM}	77- 993	mA
Input Minimum Voltage Regulation	V_{IN_MIN}	3.88 -5.08	V
Fast Charge Current	I_{CC}	26 - 1049	mA
Discharge Current	I_{DSCHG}	100 - 1600	mA

FEATURES

- Fully Autonomous Charger for Single-Cell Li-Ion/Polymer Batteries
- Current Limit for USB Port
- Complete Power Path Management for Simultaneously Powering the System and Charging the Battery
- $\pm 0.5\%$ Charging Voltage Accuracy
- 13V Maximum Voltage for the Input Source
- I²C Interface for Setting charging Parameters and Status Reporting
- Robust Charging Protection Including Battery Temperature Monitor and Programmable Timer
- Battery Disconnection Function

APPLICATIONS

- Wearable devices
- Smart Handheld Devices
- Fitness Accessories
- Smart Watches

All MPS parts are lead-free, halogen-free, and adhere to the RoHS directive. For MPS green status, please visit the MPS website under Quality Assurance. "MPS", the MPS logo, and "Simple, Easy Solutions" are trademarks of Monolithic Power Systems, Inc. or its subsidiaries.

EV2667-G-00A EVALUATION BOARD

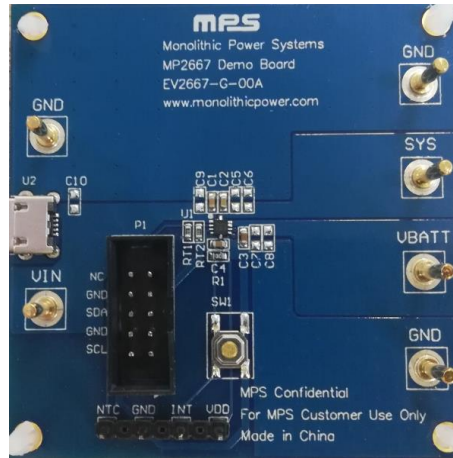

(L x W x H) 2.5" x 2.5" x 0.063"
(6.35cm x 6.35cm x 0.16cm)

Board Number	MPS IC Number
EV2667-G-00A	MP2667GG-xxxx*

*: "xxxx" is the register setting option. The factory default is "0000". This content can be viewed in I²C register map. For customer options, please contact an MPS FAE to obtain an "xxxx" value.

EVALUATION BOARD SCHEMATIC

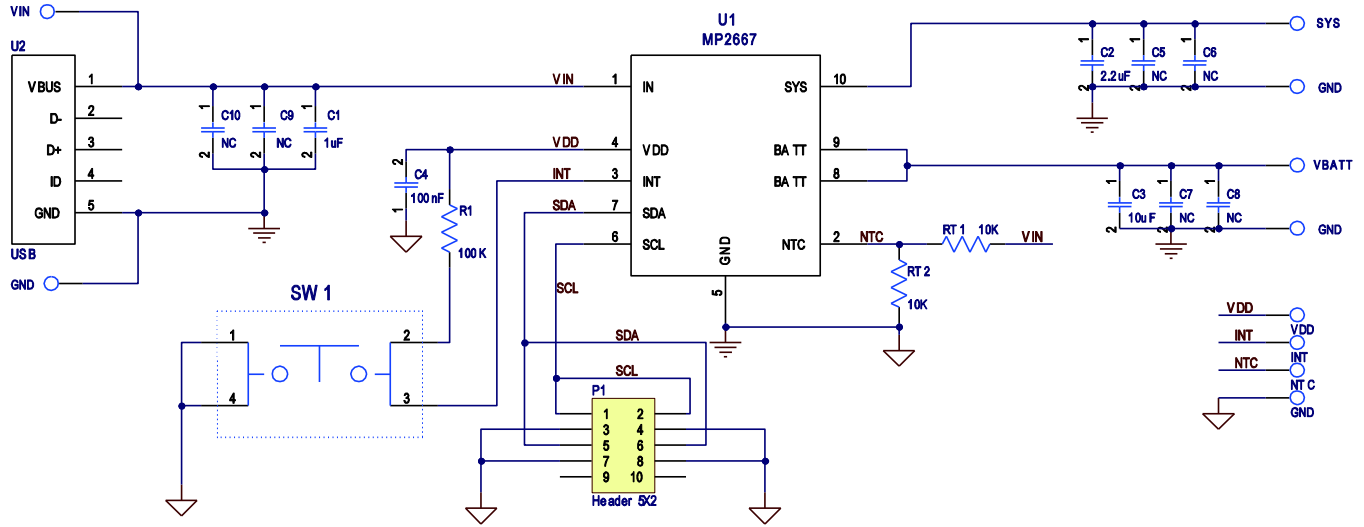

EV2667-G-00A BILL OF MATERIALS

Qty	Ref	Value	Description	Package	Manufacture	Manufacture_PN
1	C1	1µF	Ceramic Capacitor;25V;X7R;0603;	0603	muRata	GRM188R71E105KA12D
1	C2	2.2µF	Capacitor;16V;X5R	0603	muRata	GRM188R61C225KE15D
1	C3	10µF	Capacitor;16V;X5R	0603	muRata	GRM188R61C106KAALD
1	C4	100nF	Ceramic Capacitor;50V;X7R	0603	Murata	GCJ188R71H104KA12D
4	C5, C6, C7, C8	NC	Ceramic Capacitor;16V;X7R;0805	0805	muRata	GRM21BR71C475KA73L
2	C9, C10	NC	Ceramic Capacitor;25V;X7R;0805;	0805	muRata	GRM21BR71E225KA73L
1	P1		Header, 5-Pin, Dual row			
1	R1	100kΩ	Film Resistor;1%;	0603	Yageo	RC0603FR-07100KL
2	RT1, RT2	10kΩ	Film Resistor;1%;	0603	Yageo	RC0603FR-0710KL
1	U2		Micro-B USB connector;			
1	U1		2X2mm	QFN-10	MPS	MP2667GG-xxxx

PRINTED CIRCUIT BOARD LAYOUT

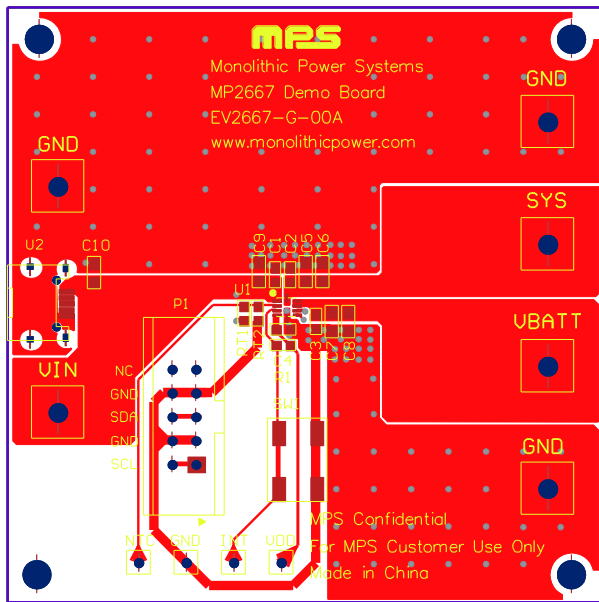

Figure 1: Top Layer

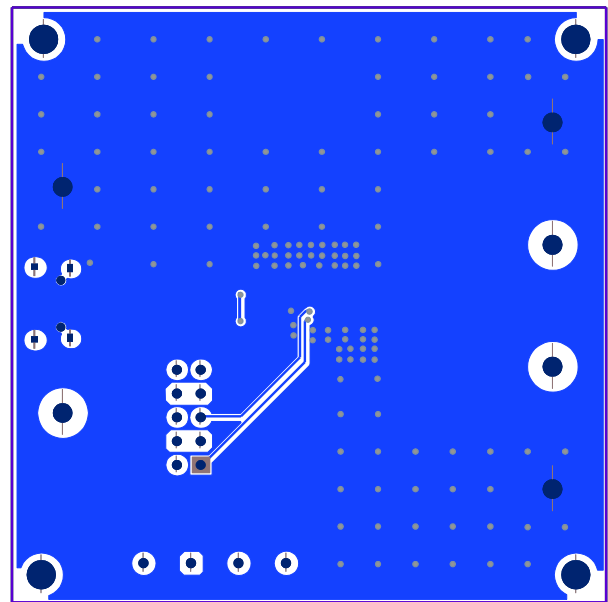

Figure 2: Bottom Layer

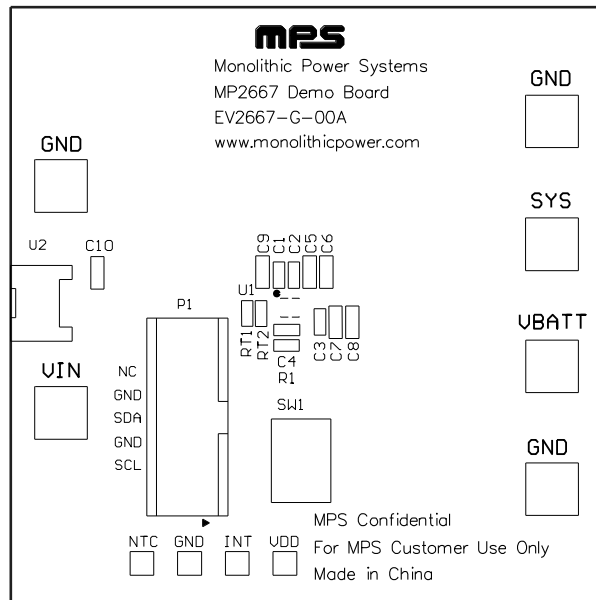

Figure 3: Top Silk Layer

QUICK START GUIDE

This board is designed for MP2667 which is a highly-integrated single-cell Li-Ion/Li-Polymer battery charger with system power path management function. And layout accommodates most commonly used capacitors. The default function of this board is preset for charger mode and the charge full voltage is preset to 4.200V for 1 cell Li-Ion battery.

Evaluation Platform Preparation:

- 1) A computer with at least one USB port and a USB cable. The MP2667 evaluation software must be properly installed.
- 2) USB-to-I²C Communication Kit (EVKT-USBI2C-02)



Figure 4: USB-to-I²C Communication Kit











- 3) Software - Double-click on the “MP2667 Evaluation Kit” EXE file to run the MP2667 evaluation software. The software supports the Windows® XP and Windows 7 operating systems.

The MP2667 Evaluation Kit EXE file is available on MPS website:

<http://hz-coc-ebench/InstallationFile.aspx?categoryID=7>

GUI

Show entries

Name	Description	Download
MP2638 Evaluation Kit	I2C evaluation kit software for MP2638, V1.1.7.	
MP2638A Evaluation Kit	Evaluation kit for MP2638A, V1.0. Parts supported: MP2638A.	
MP2650	for Charge group	
MP2660 Evaluation Kit	I2C evaluation kit software for MP2660, V1.6.7. Parts supported: MP2660.	
MP2661 Evaluation Kit	I2C evaluation kit software for MP2661, V1.1.5. Parts supported: MP2661.	
MP2662 Evaluation Kit	I2C evaluation kit software for MP2662, V1.0.	
MP2663 Evaluation Kit	I2C evaluation kit software for MP2663, V1.0. Parts supported: MP2663.	
MP2664 Evaluation Kit	I2C evaluation kit software for MP2664, V1.1.	
MP2667 Evaluation Kit NEW	I2C evaluation kit software for MP2667, V1.0. Parts supported: MP2667.	
MP2669 Evaluation Kit	I2C evaluation kit software for MP2669, V1.0.	

Previous 1 2 3 4 Next

Figure 5: MP2667 Evaluation Kit EXE file on Ebench

4) Original Test Setup for MP2667 in Figure6

Attach the input voltage ($V_{IN}=5V$) and the input ground to the VIN and GND pins, respectively.

Attach the positive and negative ends of the load to the SYS and GND pins, respectively.

Attach the positive and negative ends of the battery ($V_{BATT}=3 - 4.2V$) to the BATT and GND pins, respectively.

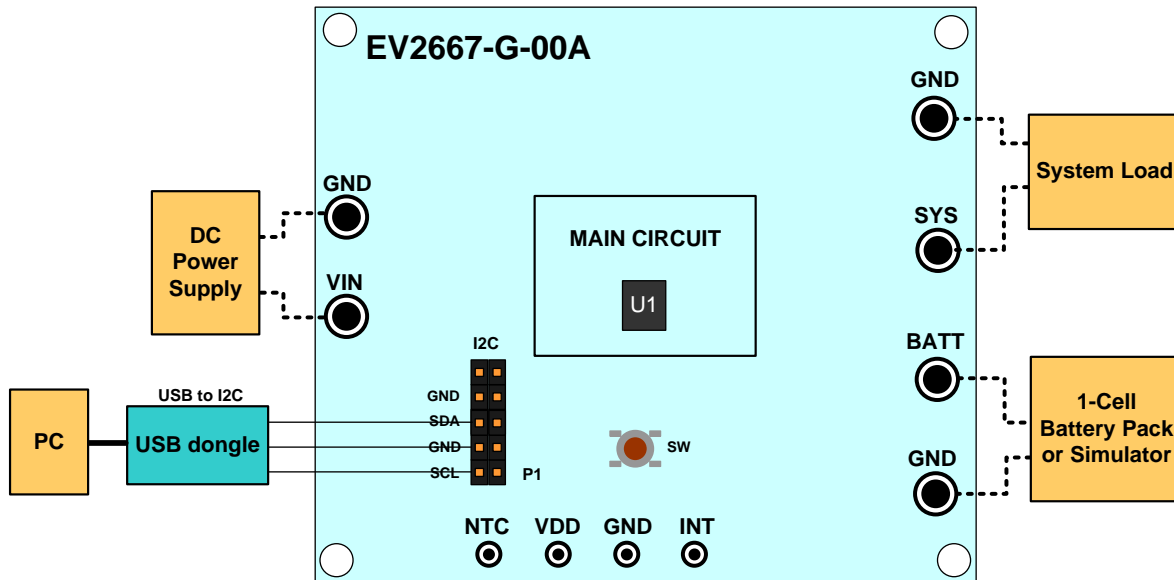

Figure 6: Test Setup for MP2667

5) Turn on the computer. Launch the MP2667 evaluation software. The main window of the software is shown in Figure 7.

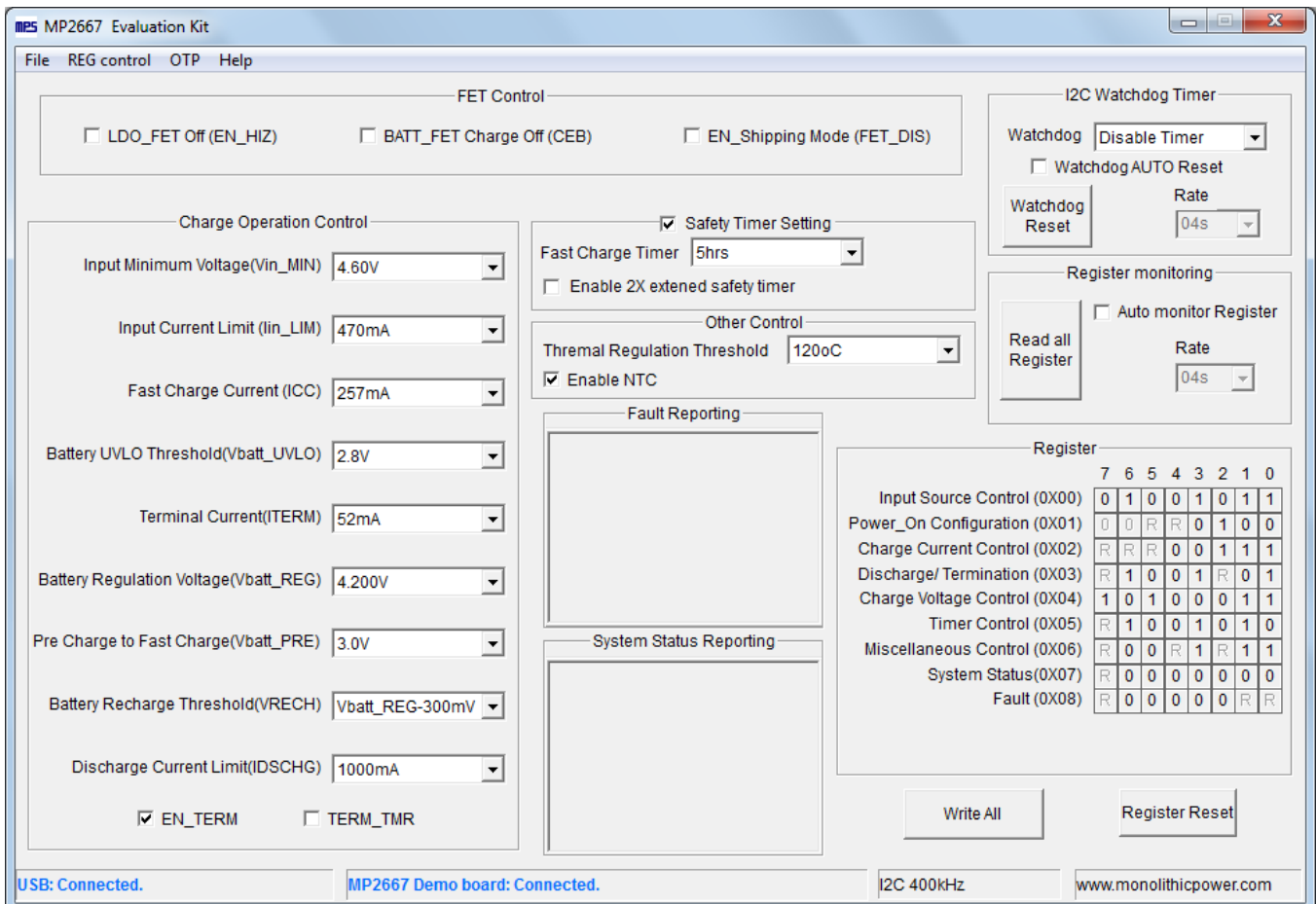

Figure 7: MP2667 evaluation interface

Procedure

Make sure all the connections are normal – both the USB-to-I2C Communication Kit and the EV2667-G-00A are connected correctly. It is ready to run the program!

Charger Function

Charge Operation Control

Input Minimum Voltage(Vin_MIN)	4.60V
Input Current Limit (Iin_LIM)	470mA
Fast Charge Current (ICC)	257mA
Battery UVLO Threshold(Vbatt_UVLO)	2.8V
Terminal Current(ITERM)	52mA
Battery Regulation Voltage(Vbatt_REG)	4.200V
Pre Charge to Fast Charge(Vbatt_PRE)	3.0V
Battery Recharge Threshold(VRECH)	Vbatt_REG-300mV
Discharge Current Limit(IDSCHG)	1000mA

EN_TERM TERM_TMR

1. Set Input Minimum Voltage at 4.60 V (the range is 3.88 - 5.08V)

Input Minimum Voltage(Vin_MIN)	4.60V
--------------------------------	-------

- 4.60V
- 4.68V
- 4.76V
- 4.84V
- 4.92V
- 5.00V
- 5.08V

2. Set Input Current Limit to 470mA (the range is 77 – 993mA)

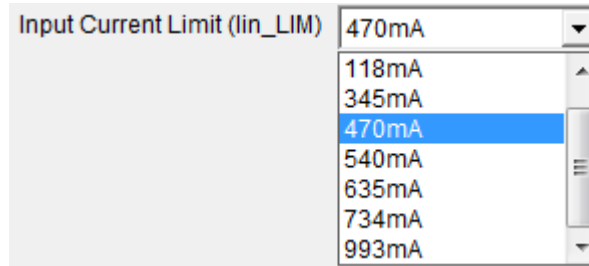

3. Set Fast Charge Current to 257mA (the range is 26 – 1049mA)

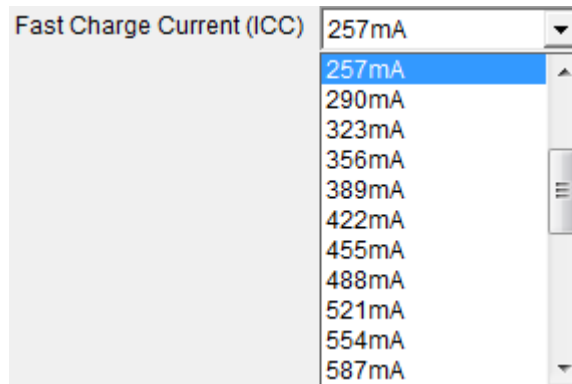

4. Set BATT UVLO threshold to 2.8V (the range is 2.4 – 3.1V)

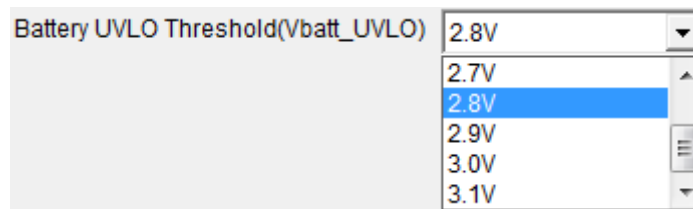

5. Set Charge Terminal Current to 52mA (the range is 24 – 108mA)

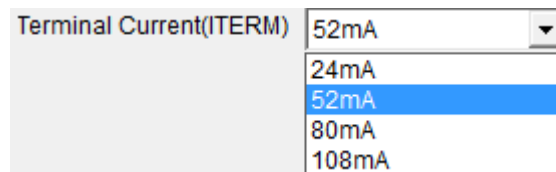

6. Set Battery Regulation Voltage to 4.200V (the range is 3.6 - 4.545V)

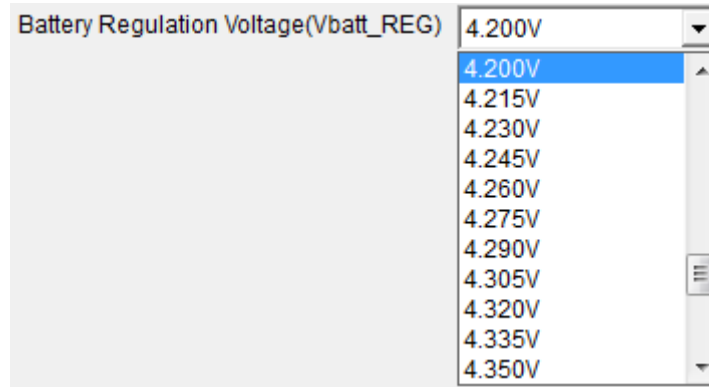

7. Set Pre - Charge to Fast Charge Threshold Voltage to 3.0 V (the range is 2.8 – 3.0V)

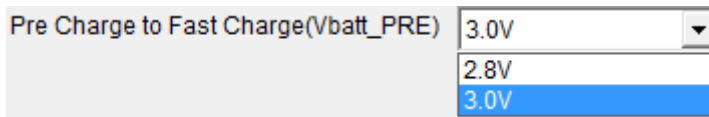

8. Set Battery Auto-recharge Voltage to $V_{BATT_REG} - 300mV$ (the range is 150mV or 300mV)

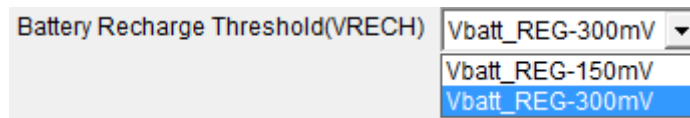

9. Set Battery Discharge Current Limit to 1000mA (the range is 100mA to 1600mA):

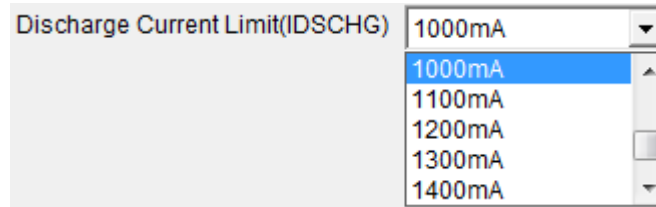

10. Termination Function Select

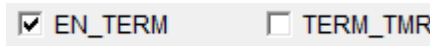

Table 1 Termination Function Selection Table

EN_TERM	TERM_TMR	After I _{BATT} hit I _{TERM} in CV mode	
		Operation	Charge Status
<input type="checkbox"/>	x	Keep CV Charge	Charge
<input checked="" type="checkbox"/>	<input type="checkbox"/>	Charge Done	Charge Done
<input checked="" type="checkbox"/>	<input checked="" type="checkbox"/>	Keep CV Charge	Charge Done

Others

1. FET Control:

FET Control

LDO_FET Off (EN_HIZ)
 BATT_FET Charge Off (CEB)
 EN_Shipping Mode (FET_DIS)

EN_HIZ only controls the on/off of the LDO FET.

CEB only control the on/off of the Battery FET in charge mode.

FET_DIS selected could turn off the Battery FET at both charge and discharge mode.

FET_DIS unselected could not turn on Battery FET; pull INT to low by push button could turn on Battery FET when it's turned off by FET_DIS.

2. Other Control.

Other Control

Thermal Regulation Threshold

Enable NTC

3. Safety Timer Setting

Safety Timer Setting

Fast Charge Timer

Enable 2X extened safety timer

4. I²C Watchdog Timer

I2C Watchdog Timer

Watchdog

Watchdog AUTO Reset

Watchdog
Reset

Rate

5. Resister Auto Monitor

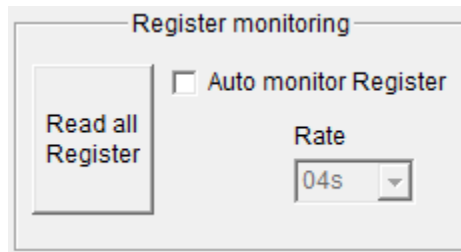

6. Content of the Registers:

Register	7	6	5	4	3	2	1	0
Input Source Control (0X00)	0	1	0	0	1	0	1	1
Power_On Configuration (0X01)	0	0	R	R	0	1	0	0
Charge Current Control (0X02)	R	R	R	0	0	1	1	1
Discharge/ Termination (0X03)	R	1	0	0	1	R	0	1
Charge Voltage Control (0X04)	1	0	1	0	0	0	1	1
Timer Control (0X05)	R	1	0	0	1	0	1	0
Miscellaneous Control (0X06)	R	0	0	R	1	R	1	1
System Status(0X07)	R	0	0	0	0	0	0	0
Fault (0X08)	R	0	0	0	0	0	R	R

7. Monitor the MP2667 operation status and Fault report

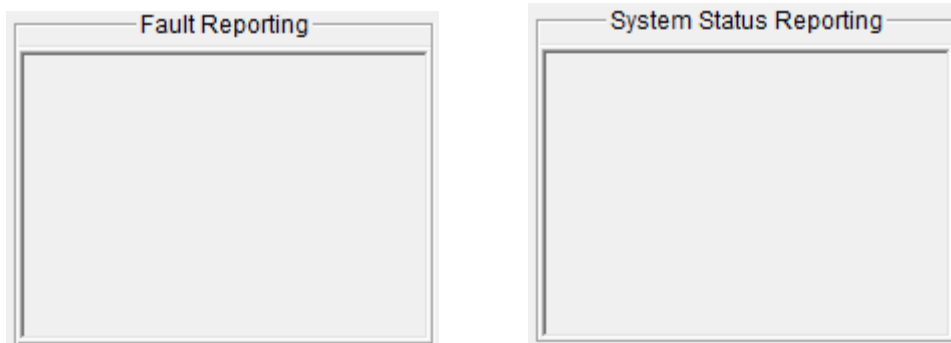

❖Notes❖

Please contact local FAE to apply:

1. The latest datasheet to get the other detailed description on the operation of this part
2. The “MP2667 Evaluation Kit” EXE file

NOTICE: The information in this document is subject to change without notice. Please contact MPS for current specifications. Users should warrant and guarantee that third party Intellectual Property rights are not infringed upon when integrating MPS products into any application. MPS will not assume any legal responsibility for any said applications.