

## DESCRIPTION

The MAQ430 detects the absolute angular position of a permanent magnet, typically a diametrically magnetized cylinder on a rotating shaft. Fast data acquisition and processing provide accurate angle measurement at speeds from 0 to 60,000 rpm.

The MAQ430 supports a wide range of magnetic field strengths and spatial configurations. Both end-of-shaft and off-axis (side-shaft mounting) configurations are supported.

The MAQ430 features magnetic field strength detection with programmable thresholds to allow sensing of the magnet position relative to the sensor for creation of functions such as sensing of axial movements or for diagnostics.

On-chip non-volatile memory provides storage for configuration parameters, including the reference zero angle position, ABZ encoder settings, UVW pole pair emulation settings, and magnetic field detection thresholds.

## FEATURES

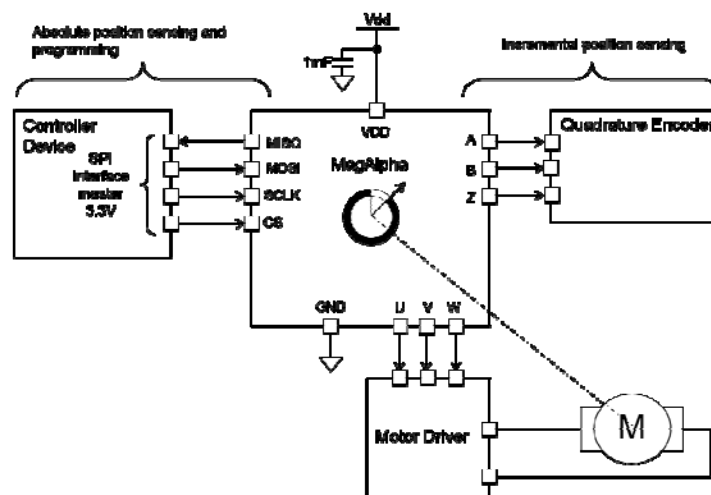
- 12-Bit Resolution Absolute Angle Encoder
- Contactless Sensing for Long Life
- AEC-Q100 qualified
- Simple and robust design
- SPI Serial Interface with parity bit for Angle Readout and Chip Configuration
- Programmable Magnetic Field Strength Detection for Diagnostic Checks
- Incremental 10-Bit ABZ Quadrature Encoder Interface with Programmable Pulses Per Turn from 1 to 256
- UVW Interface with 1 to 8 Pole Pair Emulation
- 3.3V, 12mA Supply
- -40°C to +125°C Operating Temperature
- Available in a QFN-16 (3mmx3mm) Package with Wettable flanks

## APPLICATIONS

- Brushless DC Motor Servo Drives
- Motor Commutation
- Motor Speed and Position Control
- Automotive

All MPS parts are lead-free, halogen-free, and adhere to the RoHS directive. For MPS green status, please visit the MPS website under Quality Assurance. "MPS" and "The Future of Analog IC Technology" are registered trademarks of Monolithic Power Systems, Inc.

## TYPICAL APPLICATION



### ORDERING INFORMATION

| Part Number*   | Package          | Top Marking |
|----------------|------------------|-------------|
| MAQ430GQE-AEC1 | QFN-16 (3mmx3mm) | See Below   |

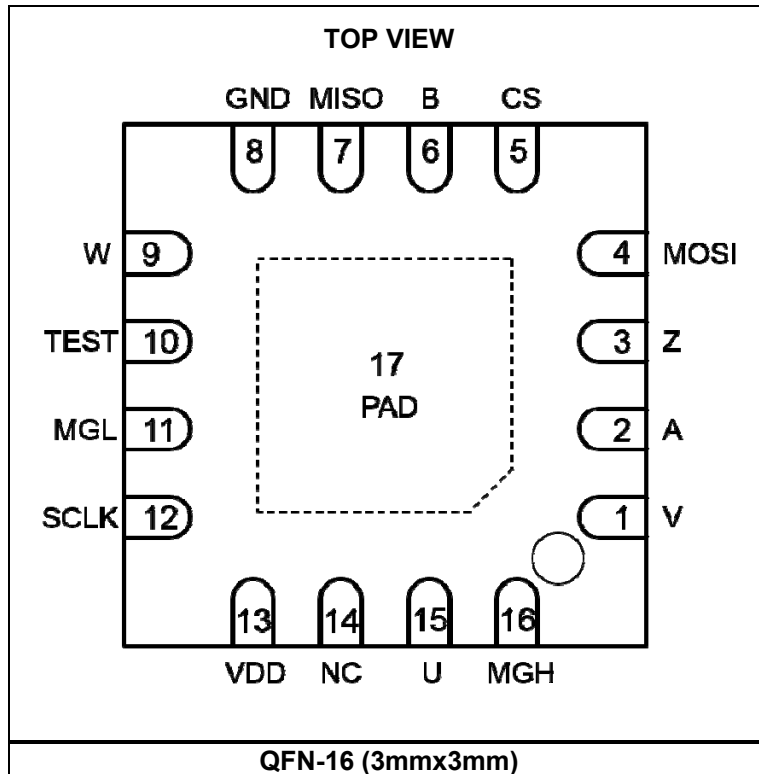
\* For Tape & Reel, add suffix -Z (e.g. MAQ430GQ-AEC1-Z)

### TOP MARKING

\_\_\_\_\_  
**BCVY**  
**LLL**

BCV: Product code of MAQ430GQE  
 Y: Year code  
 LLL: Lot number

### PACKAGE REFERENCE



**ABSOLUTE MAXIMUM RATINGS** <sup>(1)</sup>

|  |                |
|--|----------------|
| Supply voltage .....   | -0.5V to +4.6V |
| Input pin voltage (V <sub>I</sub> ) .....                            | -0.5V to +6.0V |
| Output pin voltage (V <sub>O</sub> ) .....                           | -0.5V to +4.6V |
| Continuous power dissipation (T <sub>A</sub> = +25°C) <sup>(2)</sup> |                |
| .....  | 2.0W           |
| Junction temperature .....   | 125°C          |
| Lead temperature .....   | 260°C          |
| Storage temperature .....  | -65°C to 150°C |

|  |                       |                       |      |
|--|-----------------------|-----------------------|------|
| <b>Thermal Resistance</b> <sup>(3)</sup> | <b>θ<sub>JA</sub></b> | <b>θ<sub>JC</sub></b> |      |
| QFN-16 (3mmx3mm).....                    | 50.....               | 12...                 | °C/W |

**NOTES:**

- 1) Exceeding these ratings may damage the device.
- 2) The maximum allowable power dissipation is a function of the maximum junction temperature T<sub>J</sub> (MAX), the junction-to-ambient thermal resistance θ<sub>JA</sub>, and the ambient temperature T<sub>A</sub>. The maximum allowable continuous power dissipation at any ambient temperature is calculated by P<sub>D</sub> (MAX) = (T<sub>J</sub> (MAX)-T<sub>A</sub>)/θ<sub>JA</sub>.
- 3) Measured on JESD51-7, 4-layer PCB.

**ELECTRICAL CHARACTERISTICS**

| Parameter                               | Symbol | Condition            | Min  | Typ  | Max  | Units |
|---|--------|----------------------|------|------|------|-------|
| <b>Recommended Operating Conditions</b> |        |                      |      |      |      |       |
| Supply voltage                          | VDD    |                      | 3.0  | 3.3  | 3.6  | V     |
| Supply current                          | IDD    | From -40°C to +125°C | 10.2 | 11.7 | 13.8 | mA    |
| Operating temperature                   | Top    |                      | -40  |      | 125  | °C    |
| Applied magnetic field                  | B      |                      | 30   | 60   |      | mT    |

## GENERAL CHARACTERISTICS

VDD = 3.3V, 45mT < B < 100mT, Temp = -40°C to +125°C, unless otherwise noted.

| Parameter  | Symbol  | Condition  | Min  | Typ   | Max  | Units   |
|--|---------|--|------|-------|------|---------|
| <b>Absolute Output – Serial</b>                              |         |  |      |       |      |         |
| Effective resolution   |         | 3 $\sigma$ deviation of the noise distribution   | 11.0 | 11.8  | 12.8 | bit     |
| Noise rms  |         |  | 0.01 | 0.02  | 0.03 | deg     |
| Refresh rate   |         |  | 850  | 980   | 1100 | kHz     |
| Data output length   |         |  | 16   |       | 16   | bit     |
| <b>Response Time</b>   |         |  |      |       |      |         |
| Power-up time <sup>(4)</sup>                                 |         |  |      |       | 12   | ms      |
| Latency <sup>(5)</sup>                                       |         | Constant speed propagation delay                 | 8    |       | 10   | $\mu$ s |
| Filter cutoff frequency <sup>(4)</sup>                       | Fcutoff |  |      | 390   |      | Hz      |
| <b>Accuracy</b>  |         |  |      |       |      |         |
| INL at 25°C  |         | At room temperature over the full field range    |      | 0.7   |      | deg     |
| INL between -40°C to +125°C <sup>(5)</sup>                   |         | Over the full temperature range and field range  |      | 1.1   |      | deg     |
| <b>Output Drift</b>  |         |  |      |       |      |         |
| Temperature induced drift at room temperature <sup>(5)</sup> |         |  |      | 0.015 |      | deg/°C  |
| Temperature induced variation <sup>(5)</sup>                 |         | From 25°C to 85°C                                |      | 0.5   |      | deg     |
|  |         | From 25°C to 125°C                               |      | 1.0   |      | deg     |
| Magnetic field induced <sup>(5)</sup>                        |         |  |      | 0.005 |      | deg/mT  |
| Voltage supply induced <sup>(5)</sup>                        |         |  |      |       |      | deg/V   |
| <b>Incremental Output – ABZ</b>                              |         |  |      |       |      |         |
| ABZ update rate  |         |  |      | 16    |      | MHz     |
| Resolution - edges per turn                                  |         | Programmable                                     | 4    |       | 1024 |         |
| Pulses per channel per turn                                  | PPT+1   | Programmable                                     | 1    |       | 256  |         |
| ABZ hysteresis <sup>(5)</sup>                                | H       |  |      |       | 0.7  | deg     |
| Systematic jitter <sup>(5)</sup>                             |         | For PPT = 255, between 0 and 100krpm, up to 60mT |      |       | 13   | %       |
|  |         | For PPT = 127, between 0 and 100krpm             |      |       | 7    | %       |
| Random jitter (3 $\sigma$ )                                  |         | For PPT = 255, between 0 and 100krpm             |      |       | 5.5  | %       |
|  |         | For PPT = 127, between 0 and 100krpm             |      |       | 2.8  | %       |
| Overall ABZ jitter <sup>(5)</sup>                            |         | Up to 60mT                                       |      |       | 0.3  | deg     |
| <b>Incremental Output – UVW</b>                              |         |  |      |       |      |         |
| Cycle per turn   | NPP     |  | 1    |       | 8    |         |
| UVW hysteresis <sup>(5)</sup>                                | H       |  |      |       | 0.7  | deg     |
| UVW jitter (3 $\sigma$ ) <sup>(5)</sup>                      |         |  |      | 0.1   | 0.3  | deg     |

**GENERAL CHARACTERISTICS (continued)**
**VDD = 3.3V, 45mT < B < 100mT, Temp = -40°C to +125°C, unless otherwise noted.**

| Parameter                                  | Symbol          | Condition             | Min  | Typ  | Max | Units  |
|--|-----------------|-----------------------|------|------|-----|--------|
| <b>Magnetic Field Detection Thresholds</b> |                 |                       |      |      |     |        |
| Accuracy <sup>(5)</sup>                    |                 |                       |      | 5    |     | mT     |
| Hysteresis <sup>(5)</sup>                  | MagHys          |                       |      | 6    |     | mT     |
| Temperature drift <sup>(5)</sup>           |                 |                       |      | -600 |     | ppm/°C |
| <b>Digital I/O</b>                         |                 |                       |      |      |     |        |
| Input high voltage                         | V <sub>IH</sub> |                       | 2.5  |      | 5.5 | V      |
| Input low voltage                          | V <sub>IL</sub> |                       | -0.3 |      | 0.8 | V      |
| Output low voltage <sup>(5)</sup>          | V <sub>OL</sub> | I <sub>OL</sub> = 4mA |      |      | 0.4 | V      |
| Output high voltage <sup>(5)</sup>         | V <sub>OH</sub> | I <sub>OH</sub> = 4mA | 2.4  |      |     | V      |
| Pull-down resistor                         | R <sub>PD</sub> |                       | 43   | 55   | 97  | kΩ     |
| Rising edge slew rate <sup>(4)</sup>       | T <sub>R</sub>  | CL = 50pF             |      | 0.7  |     | V/ns   |
| Falling edge slew rate <sup>(4)</sup>      | T <sub>F</sub>  | CL = 50pF             |      | 0.7  |     | V/ns   |

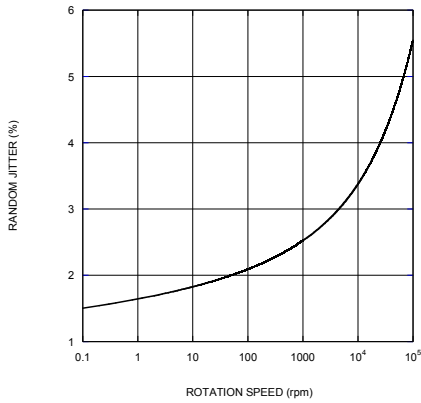
**NOTES:**

- 4) Guaranteed by design.  
 5) Guaranteed by characteristic test.

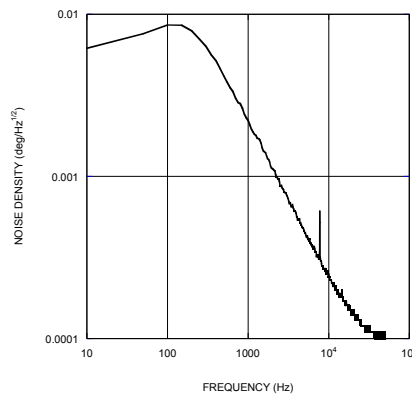
## TYPICAL CHARACTERISTICS

VDD = 3.3V, Temp = 25°C, unless otherwise noted.

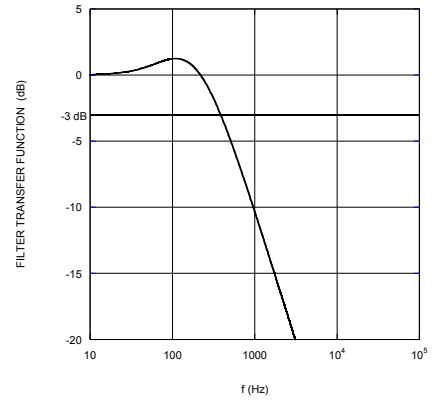
**ABZ Jitter at PPT = 255**



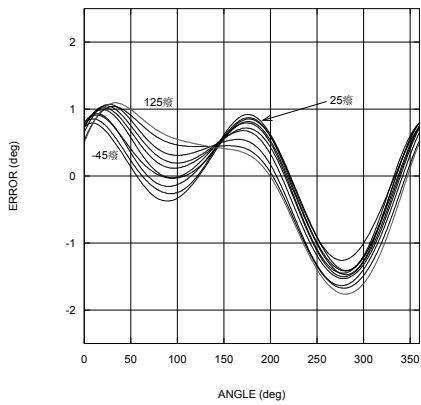
**Noise Spectrum at 50mT**



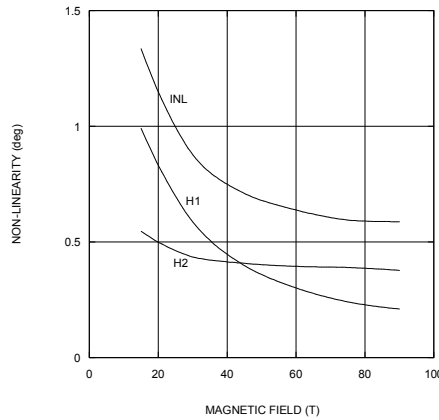
**Filter Transfer Function**



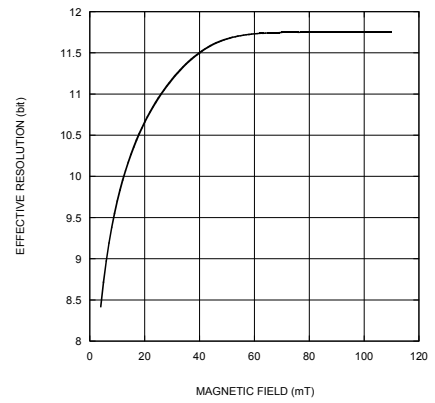
**Error Curves at 50mT**



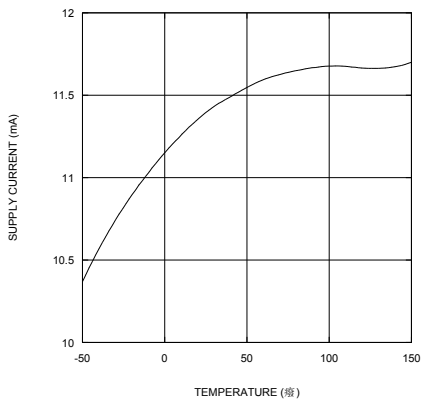
**Non-Linearity (INL and harmonics)**



**Effective Resolution (3σ)**



**Current Consumption at VDD = 3.3V**



**PIN FUNCTIONS**

| Package Pin # | Name | Description   |
|---------------|------|---|
| 1             | V    | <b>Motor commutation output.</b>  |
| 2             | A    | <b>Incremental output.</b>  |
| 3             | Z    | <b>Incremental output.</b>  |
| 4             | MOSI | <b>Data in (SPI).</b> MOSI has an internal pull-down resistor.  |
| 5             | CS   | <b>Chip select (SPI).</b> CS has an internal pull-up resistor.  |
| 6             | B    | <b>Incremental output.</b>  |
| 7             | MISO | <b>Data out (SPI).</b> MISO has an internal pull-down resistor that is enabled at a high impedance state. |
| 8             | GND  | <b>Supply ground.</b>   |
| 9             | W    | <b>Motor commutation output.</b>  |
| 10            | TEST | <b>Connect to ground.</b>   |
| 11            | MGL  | <b>Digital output indicating field strength below MGLT level.</b>   |
| 12            | SCLK | <b>Clock (SPI).</b> SCLK has an internal pull-down resistor.  |
| 13            | VDD  | <b>Supply 3.3V.</b>   |
| 14            | NC   | <b>No connection.</b> Leave NC unconnected.   |
| 15            | U    | <b>Motor commutation output.</b>  |
| 16            | MGH  | <b>Digital output indicating field strength above MGHT level.</b>   |



BLOCK DIAGRAM

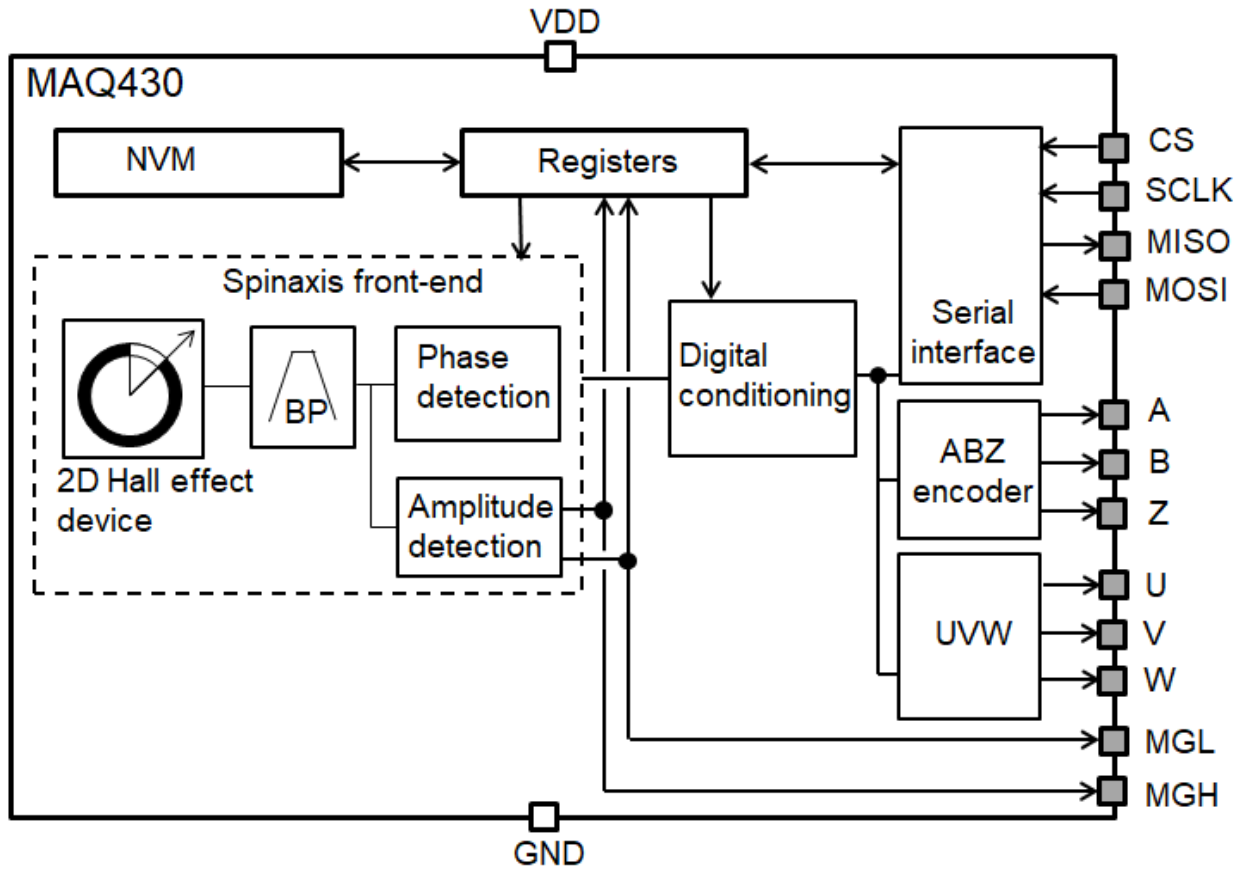


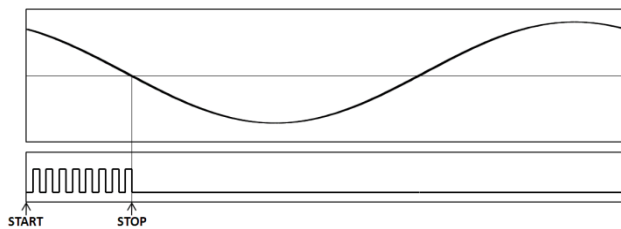
Figure 1: Functional Block Diagram

## OPERATION

### Sensor Front-End

The magnetic field is detected with integrated Hall devices located in the center of the package. The angle is measured using the *Spinaxis™* method, which directly digitizes the direction of the field without complex arctangent computation or feedback loop-based circuits (interpolators).

The *Spinaxis™* method is based on phase detection and generates a sinusoidal signal with a phase that represents the angle of the magnetic field. The angle is then obtained by a time-to-digital converter, which measures the time between the zero crossing of the sinusoidal signal and the edge of a constant waveform (see Figure 2). The time-to-digital is output from the front-end to the digital conditioning block.



**Top: Sine Waveform**  
**Bottom: Clock of Time-to-Digital Converter**  
**Figure 2: Phase Detection Method**

The output of the front-end delivers a digital number proportional to the angle of the magnetic field at the rate of 1MHz in a straightforward and open-loop manner.

### Digital Filtering

The front-end signal is further treated to achieve the final effective resolution. This treatment does not add any latency in steady conditions. The filter transfer function can be calculated with Equation (1):

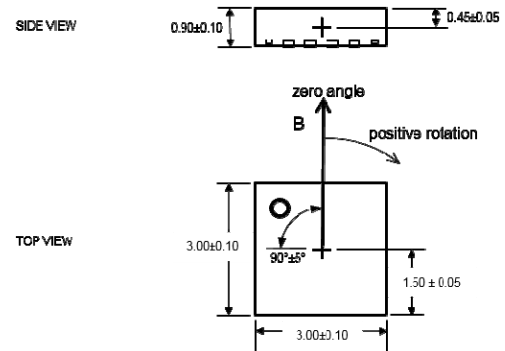
$$H(s) = \frac{1 + 2\tau s}{(1 + \tau s)^2} \quad (1)$$

Where  $\tau$  is the filter time constant, related to the cutoff frequency by  $\tau = 0.38/F_{cutoff}$ . See the General Characteristics table on page 5 for the value of *F<sub>cutoff</sub>*.

### Sensor – Magnet Mounting

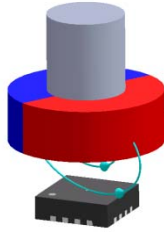
The sensitive volume of the MAQ430 is confined in a region less than 100 $\mu$ m wide and has multiple integrated Hall devices. This volume is located both horizontally and vertically within 50 $\mu$ m of the center of the QFN package. The sensor detects the angle of the magnetic field projected in a plane parallel to the package's upper surface. This means that the only relevant magnetic field is the in-plane component (X and Y components) in the middle point of the package.

By default, when looking at the top of the package, the angle increases when the magnetic field rotates clockwise. Figure 3 shows the zero angle of the unprogrammed sensor, where the cross indicates the sensitive point. Both the rotation direction and the zero angle can be programmed.

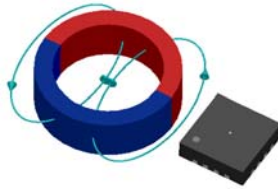


**Figure 3: Detection Point and Default Positive Direction**

This type of detection provides flexibility for the design of an angular encoder. The sensor only requires the magnetic vector to lie essentially within the sensor plane with a field amplitude of at least 30mT. Note that the MAQ430 can work with fields smaller than 30mT, but the linearity and resolution performance may deviate from the specifications. The most straightforward mounting method is to place the MAQ430 sensor on the rotation axis of a permanent magnet (i.e.: a diametrically magnetized cylinder) (see Figure 4). A typical magnet is a Neodymium alloy (N35) cylinder with dimensions  $\varnothing 5 \times 3$ mm inserted into an aluminum shaft with an air gap between the magnet and the sensor (surface of package) of 1.5mm. For good linearity, the sensor is positioned with a precision of 0.5mm.

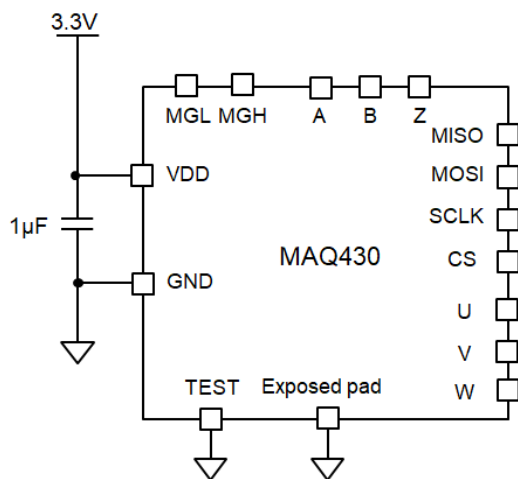

**Figure 4: End-of-Shaft Mounting**

If the end-of-shaft position is not available, the sensor can be positioned away from the rotation axis of a cylinder or ring magnet (see Figure 5). In this case, the magnetic field angle is no longer directly proportional to the mechanical angle. The MAQ430 can be adjusted to compensate for this effect and recover the linear relation between the mechanical angle and the sensor output. With multiple pole pair magnets, the MAQ430 indicates multiple rotations for each mechanical turn.


**Figure 5: Side-Shaft Mounting**

### Electrical Mounting and Power Supply Decoupling

It is recommended to place a 1 $\mu$ F decoupling capacitor close to the sensor with a low impedance path to GND (see Figure 6).


**Figure 6: Connection for Supply Decoupling**

Generally, the MagAlpha works fine with or without the exposed pad connected to anything. For optimum conditions (electrically, thermally, and mechanically), it is recommended that the exposed pad be connected to ground.

### Serial Interface

The sensor supports the SPI serial interface for angle reading and register programming.

### SPI

SPI is a 4-wire, synchronous, serial communication interface. The MagAlpha supports SPI Mode 3 and Mode 0 (see Table 1 and Table 2). The SPI Mode (0 or 3) is detected automatically by the sensor and therefore does not require any action from the user. The maximum clock rate supported on SPI is 25MHz. There is no minimum clock rate. Note that real life data rates depend on PCB layout quality and signal trace length. See Figure 7, Figure 8, and Table 3 for SPI timing.

All commands to the MagAlpha (whether for writing or reading register content) must be transferred through the SPI MOSI pin and must be 16 bits long.

For checking the integrity of the data received (angle or register content) the master shall send a 17<sup>th</sup> clock count and receive a parity bit.

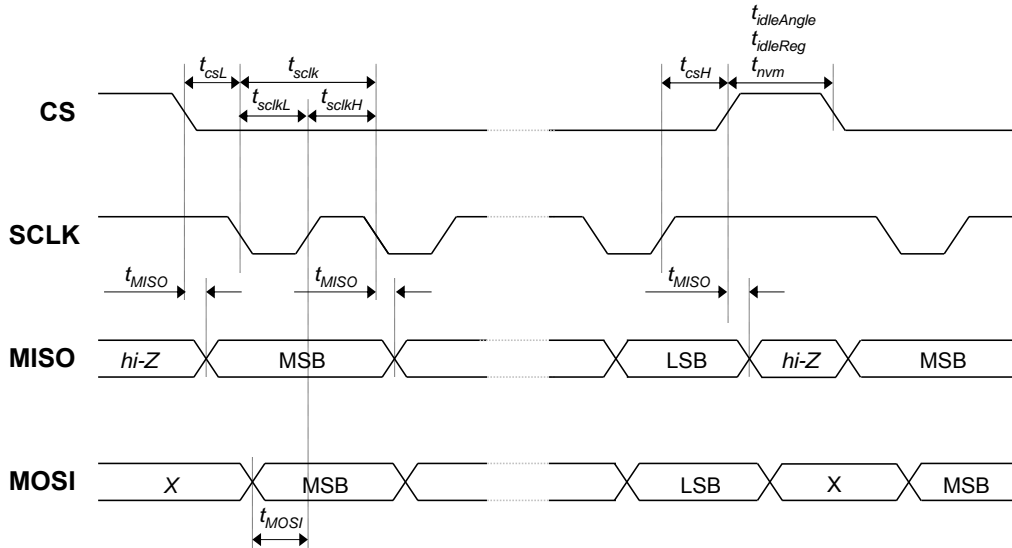
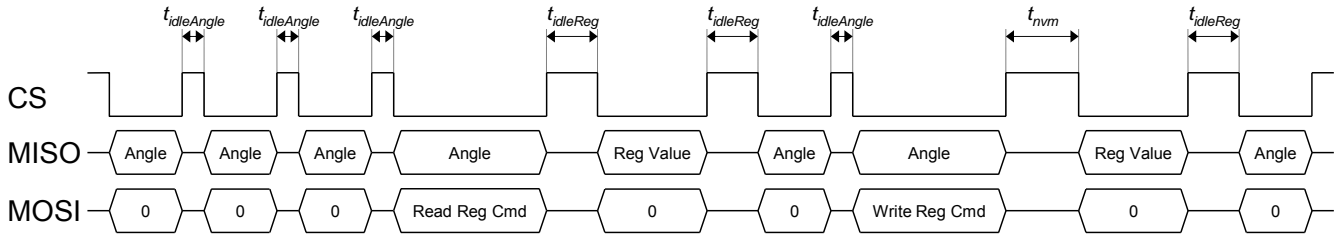
See the SPI Communication section on page 13 for details.

**Table 1: SPI Specification**

|                   | Mode 0               | Mode 3 |
|-------------------|----------------------|--------|
| SCLK idle state   | Low                  | High   |
| Data capture      | On SCLK rising edge  |        |
| Data transmission | On SCLK falling edge |        |
| CS idle state     | High                 |        |
| Data order        | MSB first            |        |

**Table 2: SPI Standard**

|                   | Mode 0        | Mode 3 |
|-------------------|---------------|--------|
| CPOL              | 0             | 1      |
| CPHA              | 0             | 1      |
| Data order (DORD) | 0 (MSB first) |        |


**Figure 7: SPI Timing Diagram**

**Figure 8: Minimum Idle Time**
**Table 3: SPI Timing**

| Parameter <sup>(6)</sup> | Description   | Min | Max | Unit |
|--------------------------|---|-----|-----|------|
| $t_{idleAngle}$          | Idle time between two subsequent angle transmissions  | 150 |     | ns   |
| $t_{idleReg}$            | Idle time before and after a register readout   | 750 |     | ns   |
| $t_{nvM}$                | Idle time between a write command and a register readout (delay necessary for non-volatile memory update) | 20  |     | ms   |
| $t_{csL}$                | Time between CS falling edge and SCLK falling edge  | 80  |     | ns   |
| $t_{sclk}$               | SCLK period   | 40  |     | ns   |
| $t_{sclkL}$              | Low level of SCLK signal  | 20  |     | ns   |
| $t_{sclkH}$              | High level of SCLK signal   | 20  |     | ns   |
| $t_{csH}$                | Time between SCLK rising edge and CS rising edge  | 25  |     | ns   |
| $t_{MISO}$               | SCLK setting edge to data output valid  |     | 15  | ns   |
| $t_{MOSI}$               | Data input valid to SCLK reading edge   | 15  |     | ns   |

**NOTE:**

6) All values are guaranteed by design.

### SPI Communication

The sensor supports three types of SPI operation:

- Read angle
- Read configuration register
- Write configuration register

Each operation has a specific frame structure described below.

#### SPI Read Angle

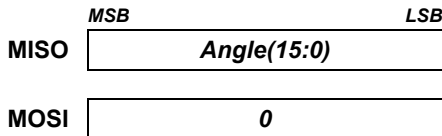
Every 1 $\mu$ s, new data is transferred into the output buffer. The master device triggers the reading by pulling CS low.

When a trigger event is detected, the data remains in the output buffer until the CS signal is de-asserted (see Table 4).

**Table 4: Sensor Data Timing**

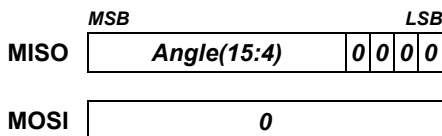
| Event           | Action                                 |
|-----------------|--|
| CS falling edge | Start reading and freeze output buffer |
| CS rising edge  | Release of the output buffer           |

See Figure 9 for a diagram of a full SPI angle reading. See Figure 10 for a diagram of a partial SPI angle reading. A full angle reading requires 16 clock pulses. The sensor MISO line returns:

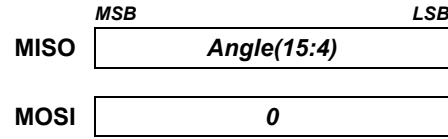


The MagAlpha family has sensors with different features and levels of resolution. Check the data output length in the General Characteristics table on page 5 for the number of useful bits delivered at the serial output. If the data length is smaller than 16, the rest of bits sent are zeros.

For example, a data output length of 12 bits means that the serial output delivers a 12-bit angle value with four bits of zeros padded at the end (MISO state remains zero). If the master sends 16 clock counts, the MagAlpha replies with:

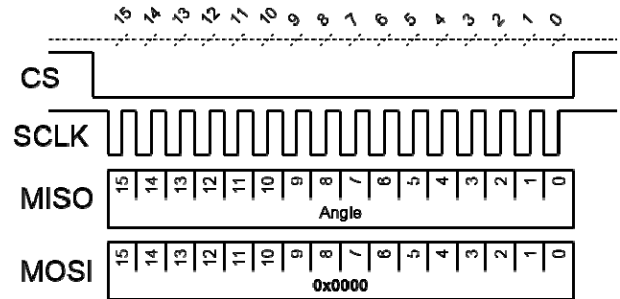


Angle reading can be therefore optimized without any loss of information by reducing the number of clock counts. In the case of a 12-bit data output length, only 12 clock counts are required to get the full sensor resolution.

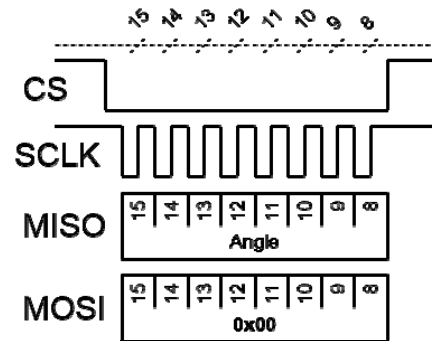


If less resolution is needed, the angle can be read by sending even fewer clock counts (since MSB is first).

In case of fast reading, the MagAlpha keeps sending the same data until the data is refreshed (see the refresh rate in the General Characteristics table).



**Figure 9: Diagram of a Full 16-Bit SPI Angle Reading**



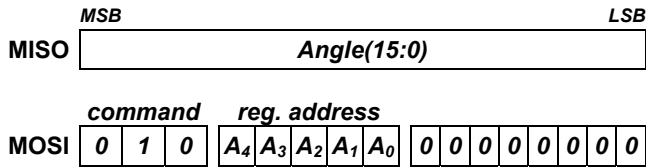
**Figure 10: Diagram of a Partial 8-Bit SPI Angle Reading**

#### SPI Read Register

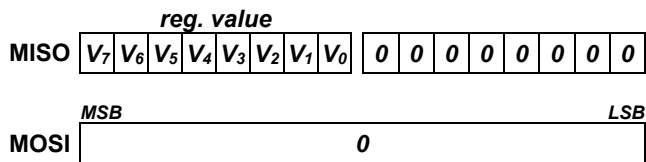
A read register operation is constituted of two 16-bit frames. The first frame sends a read request which contains the 3-bit read command (010) followed by the 5-bit register address. The

last eight bits of the frame must be all set to zero. The second frame returns the 8-bit register value (MSB byte).

The first 16-bit SPI frame (read request) is:

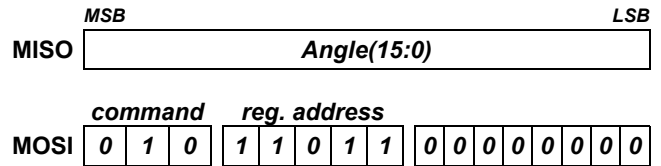


The second 16-bit SPI frame (response) is:

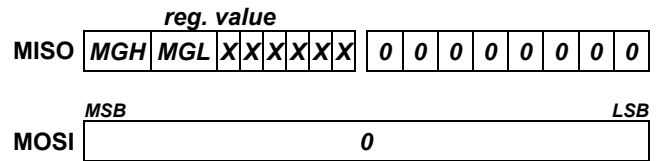


See Figure 11 for a complete transmission overview.

For example, to get the value of the magnetic level high and low flags (MGH and MGL). Read register 27 (bit 6, bit 7) by sending the following first frame:



In the second frame, the MagAlpha replies:



See Figure 12 for a complete example overview.

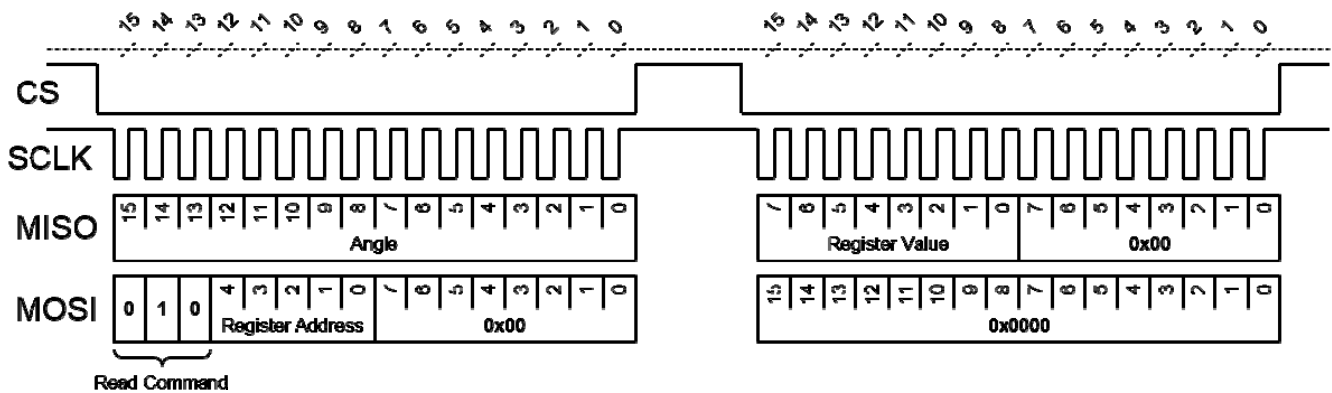


Figure 11: Two 16-Bit Frames Read Register Operation

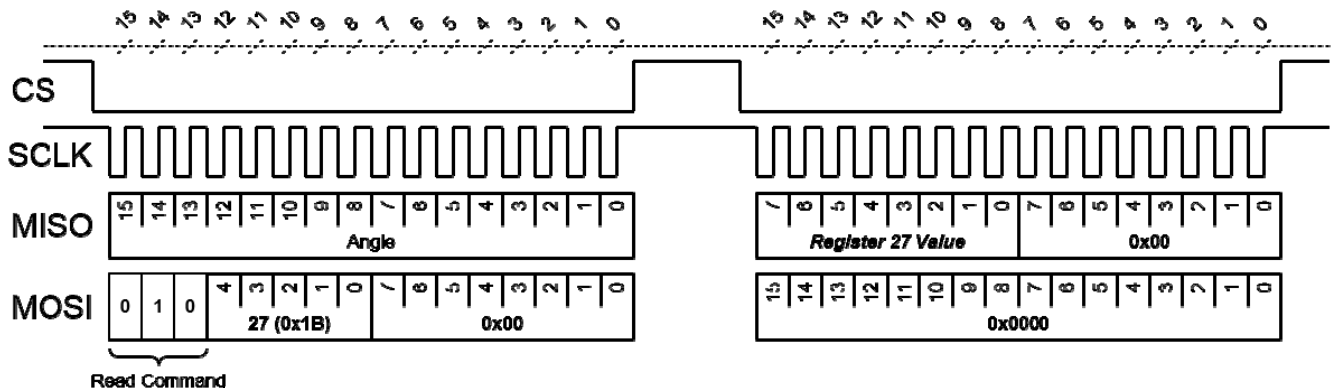


Figure 12: Example Read Magnetic Level Flags High and Low (MGH, MGL) on Register 27, Bit 7 to Bit 6

### SPI Write Register

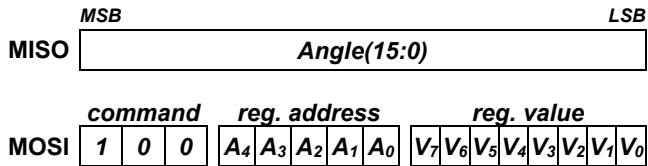
Table 5 shows the programmable 8-bit registers. Data written to these registers are stored in the on-chip non-volatile memory and reloaded automatically during power on. The factory default register values are shown in Table 6.

A write register operation is constituted of two 16-bit frames. The first frame sends a write request which contains the 3-bit write command (100) followed by the 5-bit register address and the 8-bit value (MSB first). The second frame returns the newly written register value (acknowledge).

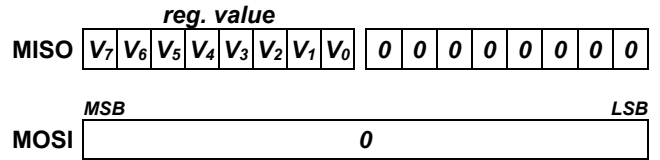
The on-chip memory is guaranteed to endure 1,000 write cycles at 25°C.

It is important to wait 20ms between the first and the second frame. This is the time taken to write the non-volatile memory. Failure to implement this wait period results in the register's previous value being read. Note that this delay is only required after a write request. A read register request and read angle do not require this wait time.

The first 16-bit SPI frame (write request) is:

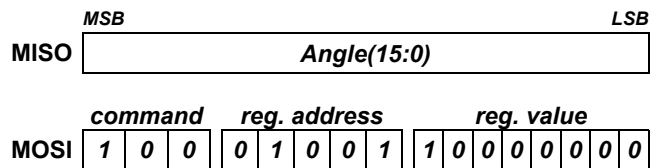


The second 16-bit SPI frame (response) is:

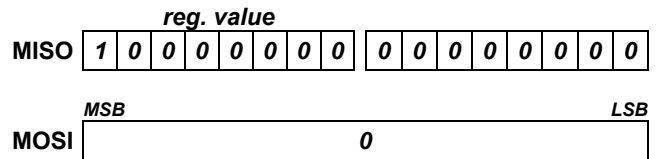


The read-back register content can be used to verify the register programming. See Figure 13 for a complete transmission overview.

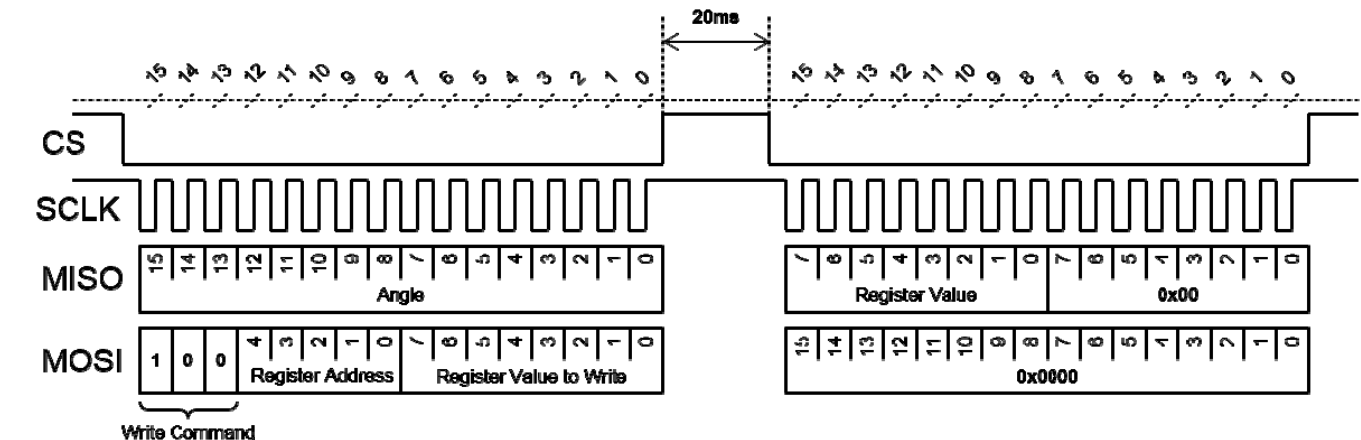
For example, to set the value of the output rotation direction (RD) to counterclockwise (high), write register 9 by sending the following first frame:



Send the second frame after a 20ms wait time. If the register is correctly written, the reply is:



See Figure 14 for a complete example.



**Figure 13: Overview of Two 16-Bit Frames Write Register Operation**

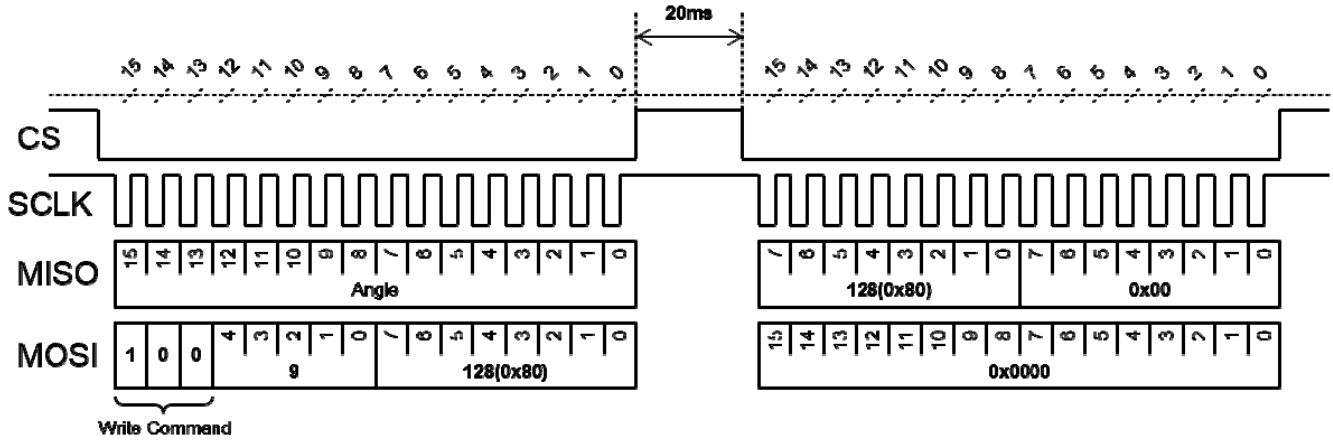


Figure 14: Example Write Output Rotation Direction (RD) to Counterclockwise (High), on Register 9, Bit 7

**Parity bit**

The parity bit, or check bit, is added to the output string to ensure that the total number of 1's in the string is even. It is used as error detecting code for angle or register reading. The MagAlpha transmits the parity bit at the 17<sup>th</sup> clock edge.

Table 5: Example of Parity bit

| 16-bits output   | Number of bits set to "1" | Output with the parity bit |
|------------------|---------------------------|----------------------------|
| 0000000000000000 | 0                         | 0000000000000000           |
| 1000110001100010 | 6                         | 1000110001100010 <b>0</b>  |
| 0101110100000000 | 5                         | 0101110100000000 <b>1</b>  |

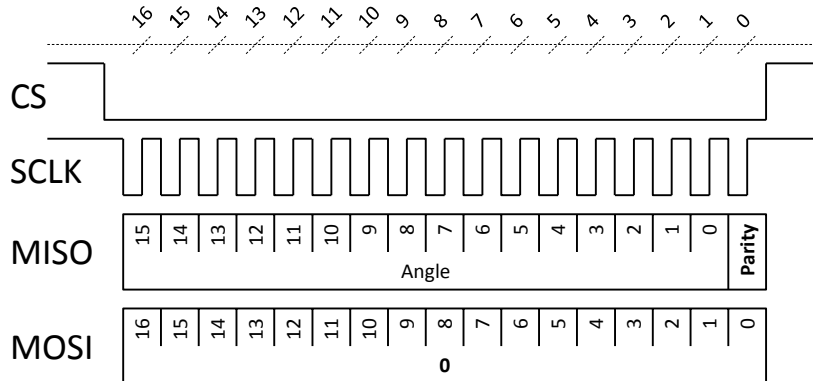


Figure 15: Angle reading with parity bit



## REGISTER MAP

**Table 5: Register Map**

| No | Hex  | Bin   | Bit 7<br>MSB | Bit 6 | Bit 5     | Bit 4     | Bit 3 | Bit 2 | Bit 1 | Bit 0<br>LSB |
|----|------|-------|--------------|-------|-----------|-----------|-------|-------|-------|--------------|
| 0  | 0x0  | 00000 | Z(7:0)       |       |           |           |       |       |       |              |
| 1  | 0x1  | 00001 | Z(15:8)      |       |           |           |       |       |       |              |
| 2  | 0x2  | 00010 | BCT(7:0)     |       |           |           |       |       |       |              |
| 3  | 0x3  | 00011 | -            | -     | -         | -         | -     | -     | ETY   | ETX          |
| 4  | 0x4  | 00100 | PPT(1:0)     |       | ILIP(3:0) |           |       | -     | -     |              |
| 5  | 0x5  | 00101 | -            | -     | PPT(7:2)  |           |       |       |       |              |
| 6  | 0x6  | 00110 | MGLT(2:0)    |       |           | MGHT(2:0) |       |       | -     | -            |
| 7  | 0x7  | 00111 | NPP(2:0)     |       |           | -         | -     | -     |       |              |
| 9  | 0x9  | 01001 | RD           | -     | -         | -         | -     | -     | -     | -            |
| 27 | 0x1B | 11011 | MGH          | MGL   | -         | -         | -     | -     | -     | -            |

**Table 6: Factory Default Values**

| No | Hex | Bin   | Bit 7<br>MSB | Bit 6 | Bit 5 | Bit 4 | Bit 3 | Bit 2 | Bit 1 | Bit 0<br>LSB |
|----|-----|-------|--------------|-------|-------|-------|-------|-------|-------|--------------|
| 0  | 0x0 | 00000 | 0            | 0     | 0     | 0     | 0     | 0     | 0     | 0            |
| 1  | 0x1 | 00001 | 0            | 0     | 0     | 0     | 0     | 0     | 0     | 0            |
| 2  | 0x2 | 00010 | 0            | 0     | 0     | 0     | 0     | 0     | 0     | 0            |
| 3  | 0x3 | 00011 | 0            | 0     | 0     | 0     | 0     | 0     | 0     | 0            |
| 4  | 0x4 | 00100 | 1            | 1     | 0     | 0     | 0     | 0     | 0     | 0            |
| 5  | 0x5 | 00101 | 0            | 0     | 1     | 1     | 1     | 1     | 1     | 1            |
| 6  | 0x6 | 00110 | 0            | 0     | 0     | 1     | 1     | 1     | 0     | 0            |
| 7  | 0x7 | 00111 | 0            | 0     | 0     | 0     | 0     | 0     | 0     | 0            |
| 9  | 0x9 | 01001 | 0            | 0     | 0     | 0     | 0     | 0     | 0     | 0            |

**Table 7: Programming Parameters**

| Parameters                    | Symbol | Number of Bits | Description   | See Table |
|-------------------------------|--------|----------------|---|-----------|
| Zero setting                  | Z      | 16             | Sets the zero position.   | 8         |
| Bias current trimming         | BCT    | 8              | For side-shaft configuration: reduces the bias current of the X or Y Hall device. | 11        |
| Enable trimming X             | ETX    | 1              | Biased current trimmed in the X-direction Hall device.                            | 12        |
| Enable trimming Y             | ETY    | 1              | Biased current trimmed in the Y-direction Hall device.                            | 12        |
| Pulses per turn               | PPT    | 8              | Number of pulses per turn of the ABZ output.                                      | 15        |
| Index length / index position | ILIP   | 4              | Parametrization of the ABZ index pulse.   | Fig. 23   |
| Magnetic field high threshold | MGHT   | 3              | Sets the field strength high threshold.   | 14        |
| Magnetic field low threshold  | MGLT   | 3              | Sets the field strength low threshold.  | 14        |
| Number of pole pairs          | NPP    | 3              | UVW cycles per turn for motor commutation.  | 17        |
| Rotation direction            | RD     | 1              | Determines the sensor positive direction.   | 10        |

## REGISTER SETTINGS

### Zero Setting

The zero position of the MagAlpha ( $a_0$ ) can be programmed with 16 bits of resolution. The angle streamed out by the MagAlpha ( $a_{out}$ ) is given by Equation (2):

$$a_{out} = a_{raw} - a_0 \quad (2)$$

Where  $a_{raw}$  is the raw angle provided by the MagAlpha front end.

The parameter Z(15:0), which is zero by default, is the complementary angle of the zero setting. In decimals, it can be written as shown in Equation (3):

$$a_0 = 2^{16} - Z(15:0) \quad (3)$$

Table 8 shows the zero setting parameter.

**Table 8: Zero Setting Parameter**

| Z(15:0) | Zero pos. $a_0$ (16-bit dec) | Zero pos. $a_0$ (deg) |
|---------|------------------------------|-----------------------|
| 0       | 65536                        | 360.000               |
| 1       | 65535                        | 359.995               |
| 2       | 65534                        | 359.989               |
| ...     | ...                          | ...                   |
| 65534   | 2                            | 0.011                 |
| 65535   | 1                            | 0.005                 |

### Example

To set the zero position to 20 degrees, the Z(15:0) parameter shall be equal to the complementary angle and can be calculated with Equation (4):

$$Z(15:0) = 2^{16} - \frac{20 \text{ deg}}{360 \text{ deg}} 2^{16} = 61895 \quad (4)$$

In binary, it is written as 1111 0001 1100 0111.

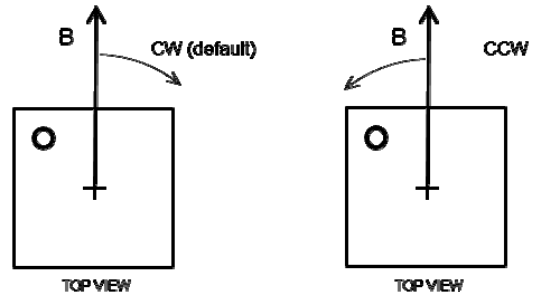
Table 9 shows the content of registers 0 and 1.

**Table 9: Register Content**

| Reg | Bit 7 | Bit 6 | Bit 5 | Bit 4 | Bit 3 | Bit 2 | Bit 1 | Bit 0 |
|-----|-------|-------|-------|-------|-------|-------|-------|-------|
| 0   | 1     | 1     | 0     | 0     | 0     | 1     | 1     | 1     |
| 1   | 1     | 1     | 1     | 1     | 0     | 0     | 0     | 1     |

### Rotation Direction

By default, when looking at the top of the package, the angle increases when the magnetic field rotates clockwise (CW) (see Figure 15 and Table 10).



**Figure 15: Positive Rotation Direction of the Magnetic Field**

**Table 10: Rotation Direction Parameter**

| RD | Positive Direction     |
|----|------------------------|
| 0  | Clockwise (CW)         |
| 1  | Counterclockwise (CCW) |

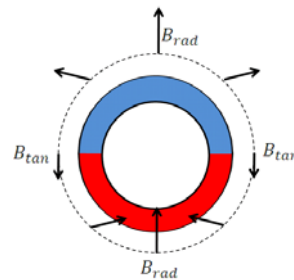
### BCT Settings (Bias Current Trimming)

#### Side-Shaft

When the MAQ430 is mounted on the side of the magnet, the relation between the field angle and the mechanical angle is no longer directly linear. This effect is related to the fact that the tangential magnetic field is usually smaller than the radial field. Define the field ratio  $k$  with Equation (5):

$$k = B_{rad} / B_{tan} \quad (5)$$

Where  $B_{rad}$  is the maximum radial magnetic field, and  $B_{tan}$  is the maximum tangential magnetic field (see Figure 16).



**Figure 16: Side-Shaft Field**

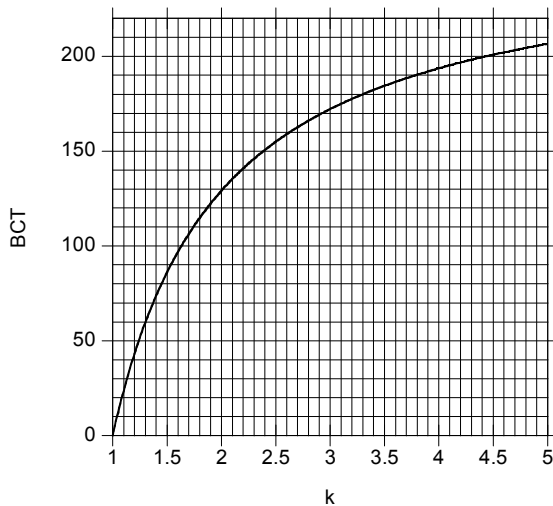
The ratio  $k$  depends on the magnet geometry and distance to the sensor. Having a  $k$  ratio different than 1 results in the sensor output response not being linear with respect to the mechanical angle. Note that the error curve has the shape of a double sinewave (see Figure 18).  $E$  is the amplitude of this error.

The X-axis or the Y-axis bias current can be reduced to recover an equal Hall signal for all angles and suppress the error. The parameter ETX and ETY controls in which direction the sensitivity is reduced. The current reduction is set by the parameter bias current trimming BCT(7:0), which is an integer from 0 to 255.

In side-shaft configuration (i.e.: the sensor center is located beyond the magnet outer diameter),  $k$  is greater than 1. For optimum compensation, the sensitivity of the radial axis should be reduced by setting the BCT parameter as shown in Equation (6):

$$BCT(7:0) = 258 \left( 1 - \frac{1}{k} \right) \quad (6)$$

Equation (6) is plotted in Figure 17 and Table 11.



**Figure 17: Relation between the  $k$  Ratio and the Optimum BCT to Recover Linearity**

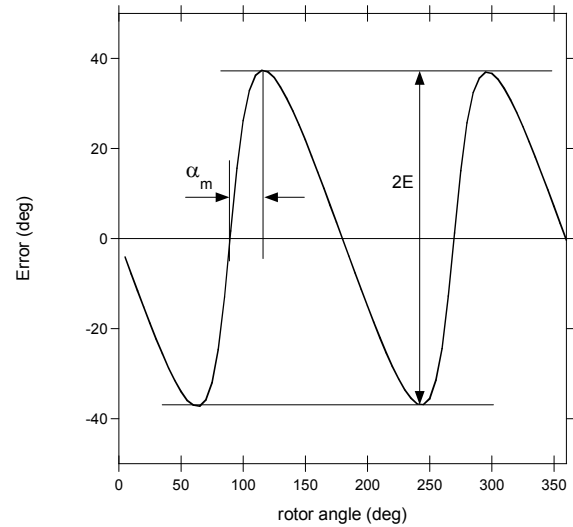
**Table 11: Example of BCT Settings**

| E (deg) | Magnet Ratio $k$ | BCT(7:0) |
|---------|------------------|----------|
| 0       | 1.0              | 0        |
| 11.5    | 1.5              | 86       |
| 19.5    | 2.0              | 129      |
| 25.4    | 2.5              | 155      |
| 30.0    | 3.0              | 172      |
| 33.7    | 3.5              | 184      |
| 36.9    | 4.0              | 194      |
| 39.5    | 4.5              | 201      |
| 41.8    | 5.0              | 207      |

### Determining $k$ with the MagAlpha

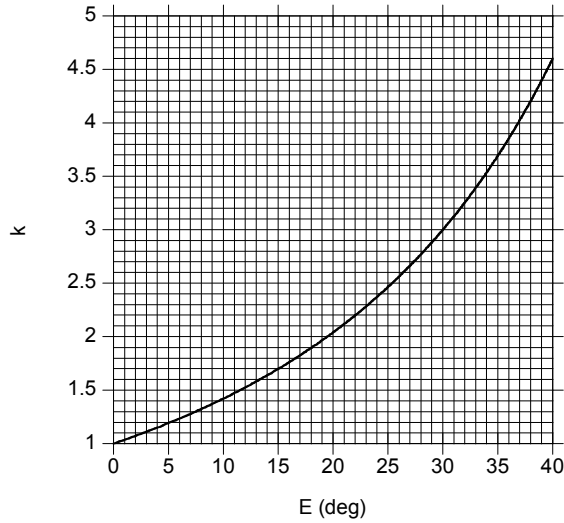
It is possible to deduce the  $k$  ratio from the error curve obtained with the default BCT setting (BCT = 0). For this purpose, rotate the magnet over one revolution and record the MagAlpha output. Then plot the error curve (the MagAlpha output minus the real mechanical position vs. the real mechanical position) and extract two parameters: the maximum error  $E$  and the position of this maximum with respect to a zero crossing  $a_m$  (see Figure 18).  $k$  can be calculated with Equation (7):

$$k = \frac{\tan(E + a_m)}{\tan(a_m)} \quad (7)$$



**Figure 18: Error Curve in Side-Shaft Configuration with BCT = 0**

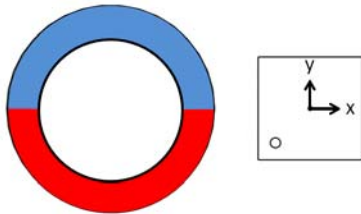
Some examples are given in Table 11. Alternatively, the  $k$  parameter can be obtained from the graph of Figure 19.



**Figure 19: Relation between the Error Measured with BCT = 0 and the Magnet Ratio  $k$**

### Sensor Orientation

The dot marked on the package shows whether the radial field is aligned with the sensor coordinate X or Y (see Figure 20).



**Figure 20: Package Top View with X and Y Axes**

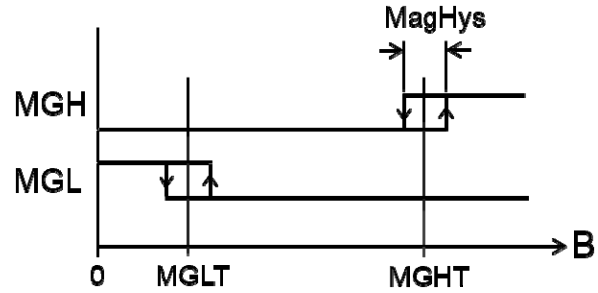
Determine which axis needs to be reduced (see the qualitative field distribution around a ring in Figure 16). For instance, with the arrangement depicted in Figure 20, the field along the sensor Y direction is tangential and weaker. Therefore, the X-axis should be reduced (ETX = 1 and ETY = 0). Note that if both ETX and ETY are set to 1, the current bias is reduced in both directions the same way (i.e.: without side-shaft correction).

**Table 12: Trimming Direction Parameters**

| ETX | Enable Trimming of the X-Axis |
|-----|-------------------------------|
| 0   | Disabled                      |
| 1   | Enabled                       |
| ETY | Enable Trimming of the Y-Axis |
| 0   | Disabled                      |
| 1   | Enabled                       |

### Magnetic Field Thresholds

The magnetic flags (MGL and MGH) indicate that the magnetic field at the sensor position is out of range, defined by the lower and upper magnetic field thresholds, respectively MGLT and MGHT (see Figure 21).



**Figure 21: MGH and MGL Signals as a Function of the Field Strength**

MagHys, the typical hysteresis on the signals MGH and MGL, is 6mT (see Figure 24). The MGLT and MGHT thresholds are coded on three bits and stored in register 6 (see Table 13).

**Table 13: Register 6**

| Register 6 |       |       |       |       |       |       |       |
|------------|-------|-------|-------|-------|-------|-------|-------|
| Bit 7      | Bit 6 | Bit 5 | Bit 4 | Bit 3 | Bit 2 | Bit 1 | Bit 0 |
| MGLT       |       |       | MGHT  |       |       | -     | -     |

The 3-bit values of MGLT and MGHT correspond to the magnetic field (see Table 14).

**Table 14: MGLT and MGHT Binary to mT Relation**

| MGLT or MGHT <sup>(8)</sup> | Field threshold in mT <sup>(7)</sup> |                                  |
|-----------------------------|--------------------------------------|----------------------------------|
|                             | From low to high magnetic. field     | From high to low magnetic. field |
| 000                         | 26                                   | 20                               |
| 001                         | 41                                   | 35                               |
| 010                         | 56                                   | 50                               |
| 011                         | 70                                   | 64                               |
| 100                         | 84                                   | 78                               |
| 101                         | 98                                   | 92                               |
| 110                         | 112                                  | 106                              |
| 111                         | 126                                  | 120                              |

**NOTES:**

- 7) Valid for VDD = 3.3V. If different, then the field threshold is scaled by the factor VDD/3.3V.
- 8) MGLT can have a larger value than MGHT.

The alarm flags MGL and MGH can be read in register 27 (bit 6 and bit 7), and their logic state is also given at the digital output pins 11 and 16.

To read the MGL and MGH flags by SPI, send the 8-bit command write into register 27:

| command | reg. address | MSB | value           | LSB |
|---------|--------------|-----|-----------------|-----|
| 0 1 0   | 1 1 0 1 1    | 0   | 0 0 0 0 0 0 0 0 | 0   |

The MAQ430 answers with the register 27 content in the next transmission:

| R[7:0] |     |   |   |   |   |   |   |
|--------|-----|---|---|---|---|---|---|
| MGH    | MGL | x | x | x | x | x | x |

### Front-end diagnostics

If the thresholds are set correctly, i.e. the magnetic field is between the MGLT and MGHT values, then register 27 also provides diagnostic coverage of the sensor front-end. Integrity is indicated by the following values in register 27:

| R[7:0] |   |   |   |   |   |   |   |
|--------|---|---|---|---|---|---|---|
| 0      | 0 | 0 | 0 | 1 | 1 | 1 | 1 |

### ABZ Incremental Encoder Output

The MAQ430 ABZ output emulates a 10-bit incremental encoder (such as an optical encoder) providing logic pulses in quadrature (see Figure 22). Compared to signal A, signal B is shifted by a quarter of the pulse period. Over one revolution, signal A pulses  $N$  times, where  $N$  is programmable from 1 to 256 pulses per revolution. The number of pulses per channel per revolution is programmed by setting the parameter PPT, which consists of eight bits split between registers 0x4 and 0x5 (see Table 5). The factory default value is 256. Table 15 describes how to program PPT(7:0) to set the required resolution.

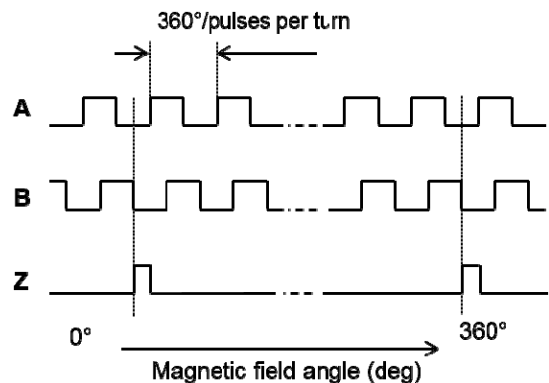
**Table 15: PPT**

| PPT(7:0) | Pulses per Turn | Edges per Turn |     |
|----------|-----------------|----------------|-----|
| 00000000 | 1               | 4              | MIN |
| 00000001 | 2               | 8              |     |
| 00000010 | 3               | 12             |     |
| 00000011 | 4               | 16             |     |
| ...      | ...             | ...            | ... |
| 11111100 | 253             | 1012           |     |
| 11111101 | 254             | 1016           |     |
| 11111110 | 255             | 1020           |     |
| 11111111 | 256             | 1024           | MAX |

For example, to set 120 pulses per revolution (480 edges), set PPT to 120 - 1 = 119 (binary: 01110111). Registers 4 and 5 must be set as shown in Table 16.

**Table 16: Register 4 and Register 5**

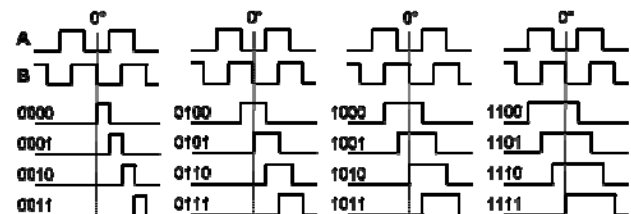
|    | B7 | B6 | B5 | B4 | B3 | B2 | B1 | B0 |
|----|----|----|----|----|----|----|----|----|
| R4 | 1  | 1  | 0  | 0  | 0  | 0  | 0  | 0  |
| R5 | 0  | 0  | 0  | 1  | 1  | 1  | 0  | 1  |



**Figure 22: Timing of the ABZ Output**

Signal Z (zero or index) raises only once per turn at the zero-angle position.

The position and length of the Z pulse is programmable via bit ILIP(3:0) in register 0x5 (see Figure 23).

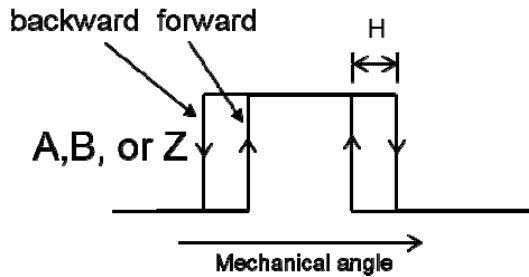


**Figure 23: ILIP Parameter Effect on Index Shape**

By default, the ILIP parameter is 0000. The index rising edge is aligned with the channel B falling edge and the index length is half the A or B pulse length.

### ABZ Hysteresis

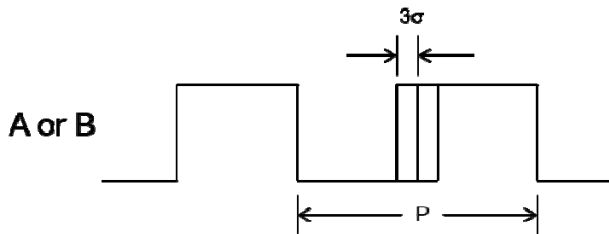
A hysteresis larger than the output noise is introduced on the ABZ output to prevent any spurious transitions (see Figure 24).



**Figure 24: Hysteresis of the Incremental Output ABZ Jitter**

The ABZ state is updated at a frequency of 16MHz, enabling accurate operation up to a very high rpm (above  $10^5$  rpm).

The jitter characterizes how far a particular ABZ edge can occur at an angular position different from the ideal position (see Figure 25).



**Figure 25: ABZ Jitter**

The measurable jitter is composed of a systematic jitter (always the same deviation at a given angle) and a random jitter.

The random jitter reflects the sensor noise, so the edge distribution is the same as the SPI output noise. Like the sensor resolution, it is defined as the  $3\sigma$  width of this distribution.

The random jitter is a function of the rotation speed. At lower speeds, the random jitter is smaller than the sensor noise (see the Typical Characteristic curves on page 7).

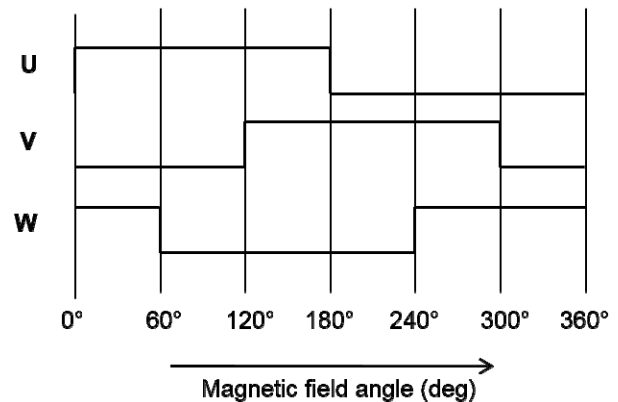
This is a consequence of the fact that the probability of measuring an edge at a certain distance from the ideal position depends on the number of ABZ updates at this position.

The minimum field for ABZ reading is 30mT.

### Block Commutation – UVW

The UVW output emulates the three Hall switches usually used for the block commutation of a three-phase electric motor. The three logic signals have a duty cycle of

50% and are shifted by  $60^\circ$  relative to each other (see Figure 26).



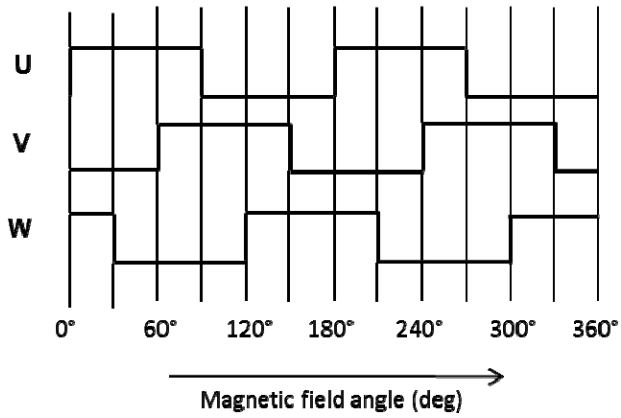
**Figure 26: UVW Output for One Pole Pair Rotor during Rotation**

If the number of pole pairs of the motor exceeds the number of pole pairs of the target magnet, the MAQ430 is able to generate more than one UVW cycle per revolution. It does this by dividing the digital angle into the required number of commutation steps per  $360^\circ$  revolution. The parameter NPP(2:0) in register 0x7 sets the number of pole pairs emulated, and the corresponding commutation step angle for the UVW signals. Table 17 describes the pole pair configuration options.

**Table 17: Number of UVW Pair Poles**

| NPP (2:0) | Pole Pairs | States per Revolution | State Width (deg) |
|-----------|------------|-----------------------|-------------------|
| 000       | 1          | 6                     | 60                |
| 001       | 2          | 12                    | 30                |
| 010       | 3          | 18                    | 20                |
| 011       | 4          | 24                    | 15                |
| 100       | 5          | 30                    | 12                |
| 101       | 6          | 36                    | 10                |
| 110       | 7          | 42                    | 8.6               |
| 111       | 8          | 48                    | 7.5               |

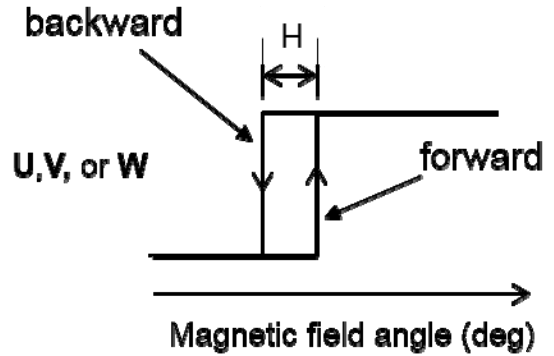
An example of the 30° UVW commutation signal spacing for a four-pole (two-pole pair) motor is shown in Figure 27.



**Figure 27: UVW Commutation Signals for a Four-Pole (Two-Pole Pair) Motor**

**UVW Hysteresis**

A hysteresis larger than the output noise is introduced on the UVW output to avoid any spurious transitions (see Figure 28).



**Figure 28: Hysteresis of the UVW Signal**



### TYPICAL APPLICATION CIRCUITS

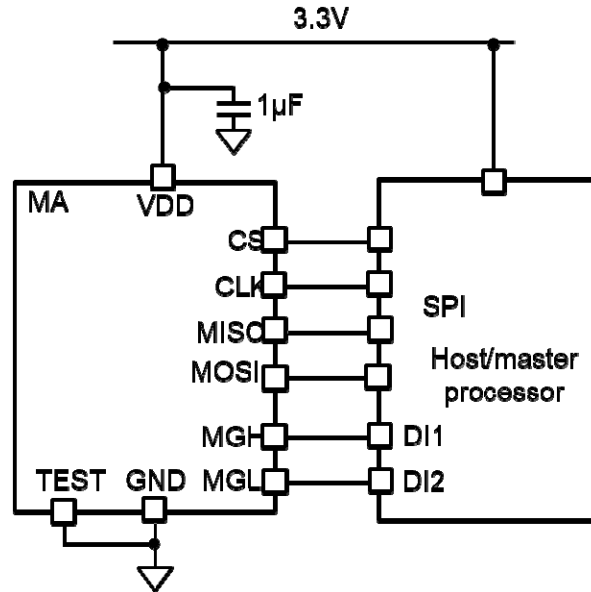


Figure 29: Typical Configurations Using SPI Interface and MGH/MGL Signals

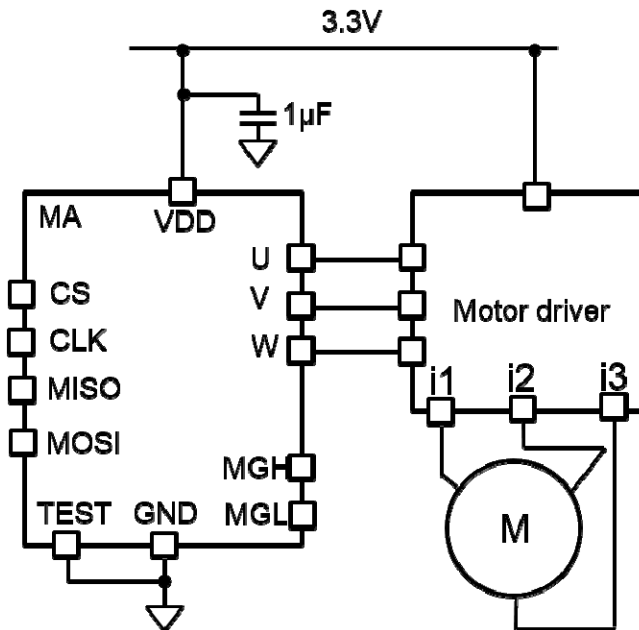
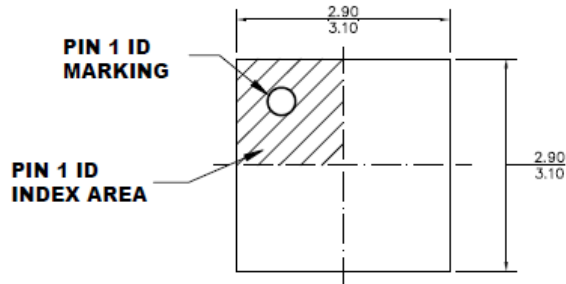


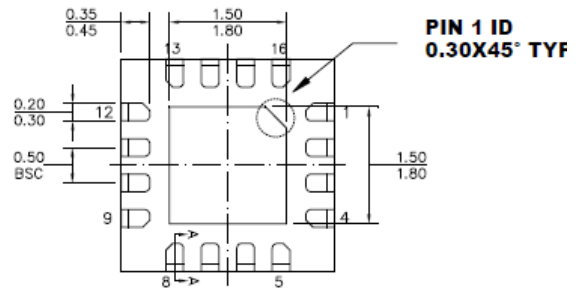
Figure 30: Typical Motor Configuration Using UVW Commutation Signals

**PACKAGE INFORMATION**

**QFN-16 (3mmx3mm)**



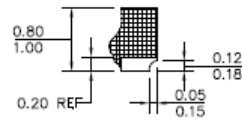
**TOP VIEW**



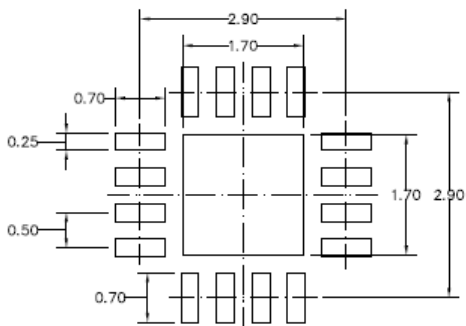
**BOTTOM VIEW**



**SIDE VIEW**



**SECTION A-A**



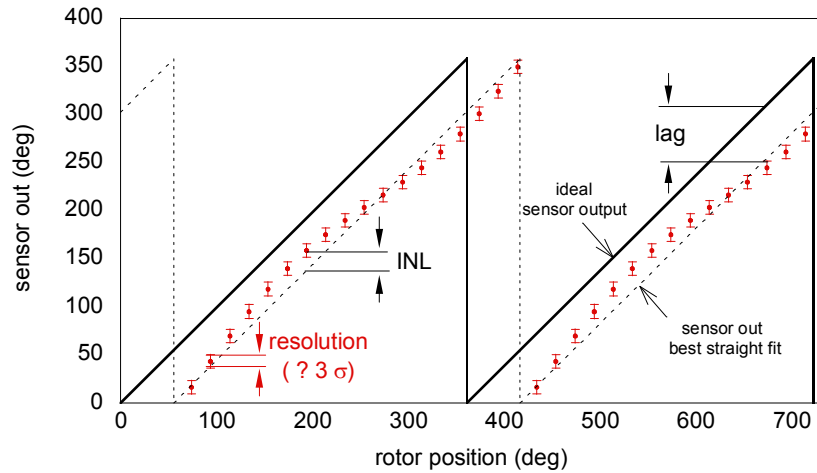
**RECOMMENDED LAND PATTERN**

**NOTE:**

- 1) THE LEAD SIDE IS WETTABLE.
- 2) ALL DIMENSIONS ARE IN MILLIMETERS.
- 3) EXPOSED PADDLE SIZE DOES NOT INCLUDE MOLD FLASH.
- 4) LEAD COPLANARITY SHALL BE 0.08 MILLIMETERS MAX.
- 5) JEDEC REFERENCE IS MO-220.
- 6) DRAWING IS NOT TO SCALE.

## APPENDIX A: DEFINITIONS

- Effective Resolution ( $3\sigma$  noise level)** The smallest angle increment distinguishable from the noise. The resolution is measured by computing 3 times  $\sigma$  (the standard deviation in degrees) taken over 1,000 data points at a constant position. The resolution in bits is obtained with  $\log_2(360/6\sigma)$ .
- Refresh Rate** Rate at which new data points are stored in the output buffer.
- ABZ Update Rate** Rate at which a new ABZ state is computed. The inverse of this rate is the minimum time between 2 ABZ edges.
- Latency** The time elapsed between the instant when the data is ready to be read and the instant at which the shaft passes that position. The lag in degrees is  $lag = latency \cdot \omega$ , where  $\omega$  is the angular velocity in deg/s.
- Power-Up Time** Time until the sensor delivers valid data starting at power-up.
- Integral Non-Linearity (INL)** Maximum deviation between the average sensor output (at a fixed position) and the true mechanical angle.



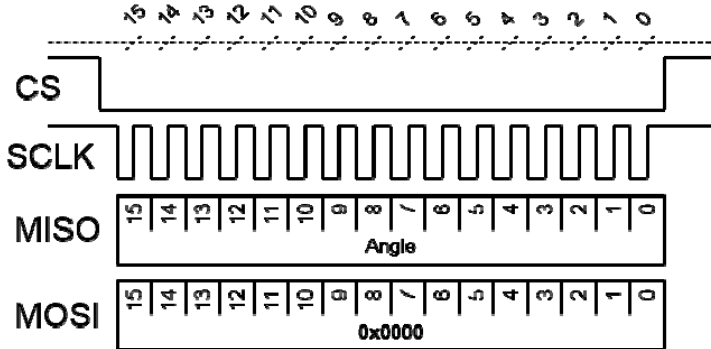
It can be obtained from the error curve  $err(\alpha) = out(\alpha) - \alpha$ , where  $out(\alpha)$  is the average over 1,000 sensor outputs, and  $\alpha$  is the mechanical angle indicated by a high precision encoder ( $<0.001$  deg). The INL is then computed with:

$$INL = \frac{\max(err(a)) - \min(err(a))}{2} \quad (A1)$$

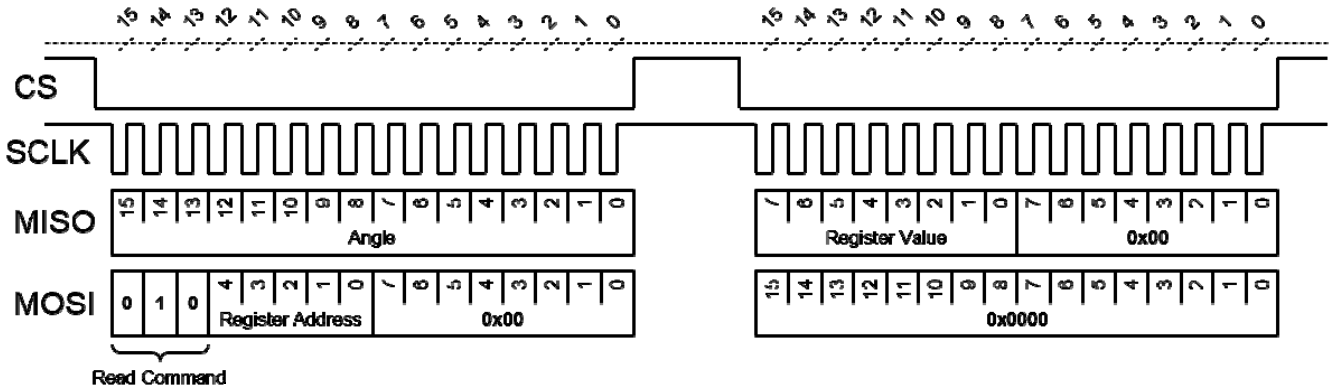
- Drift** Angle variation rate when one parameter is changed (e.g.: temperature, VDD) and all the others, including the shaft angle, are maintained constant.

## APPENDIX B: SPI COMMUNICATION CHEATSHEET

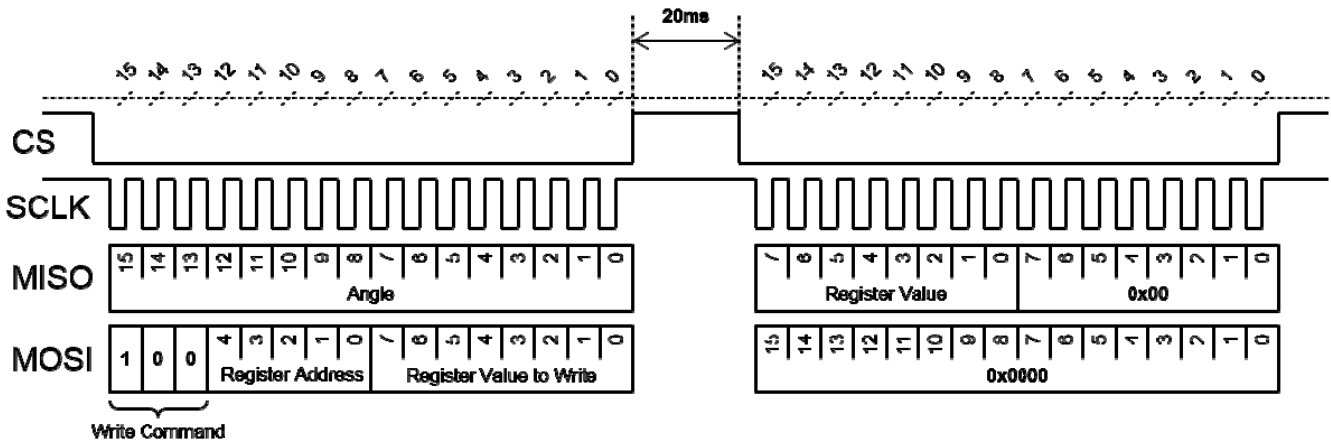
### Read Angle



### Read Register



### Write Register



**NOTICE:** The information in this document is subject to change without notice. Users should warrant and guarantee that third party Intellectual Property rights are not infringed upon when integrating MPS products into any application. MPS will not assume any legal responsibility for any said applications.