

Sure Cross® MultiHop H4 Data Radio



Datasheet

The Sure Cross® wireless system is a radio frequency network with integrated I/O that operates in most environments to eliminate the need for wiring runs. Wireless MultiHop data radio networks are formed around a MultiHop master and one or more slaves and extend the range of a Modbus or other serial communication network.



- Wireless industrial I/O device with four Pt100 RTD inputs
- Selectable transmit power levels of 250 mW or 1 Watt for 900 MHz models and 65 mW for 2.4 GHz models
- *FlexPower*® power options allow for 10 V DC to 30 V DC, solar, and battery power sources for low power applications.
- Self-healing, auto-routing RF network with multiple hops extends the network's range
- Serial and I/O communication on a Modbus platform
- Message routing improves link performance
- DIP switches select operational modes: master, repeater, or slave
- Built-in site survey mode enables rapid assessment of a location's RF transmission properties
- Frequency Hopping Spread Spectrum (FHSS) technology ensures reliable data delivery within the unlicensed Industrial, Scientific, and Medical (ISM) band



Important: Please download the complete Sure Cross® MultiHop Data Radio technical documentation, available in multiple languages, from www.bannerengineering.com for details on the proper use, applications, Warnings, and installation instructions of this device.



Important: Por favor descargue desde www.bannerengineering.com toda la documentación técnica de los Sure Cross® MultiHop Data Radio, disponibles en múltiples idiomas, para detalles del uso adecuado, aplicaciones, advertencias, y las instrucciones de instalación de estos dispositivos.



Important: Veuillez télécharger la documentation technique complète des Sure Cross® MultiHop Data Radio sur notre site www.bannerengineering.com pour les détails sur leur utilisation correcte, les applications, les notes de sécurité et les instructions de montage.



WARNING:

- **Do not use this device for personnel protection**
- Using this device for personnel protection could result in serious injury or death.
- This device does not include the self-checking redundant circuitry necessary to allow its use in personnel safety applications. A device failure or malfunction can cause either an energized (on) or de-energized (off) output condition.



Important:

- **Never operate a 1 Watt radio without connecting an antenna**
- Operating 1 Watt radios without an antenna connected will damage the radio circuitry.
- To avoid damaging the radio circuitry, never apply power to a Sure Cross® Performance or Sure Cross MultiHop (1 Watt) radio without an antenna connected.



Important:

- **Electrostatic discharge (ESD) sensitive device**
- ESD can damage the device. Damage from inappropriate handling is not covered by warranty.
- Use proper handling procedures to prevent ESD damage. Proper handling procedures include leaving devices in their anti-static packaging until ready for use; wearing anti-static wrist straps; and assembling units on a grounded, static-dissipative surface.

Models

| Models | Frequency | Power | Housing | I/O |
|--------------|------------------|--|-------------------|--|
| DX80DR9M-H4 | 900 MHz ISM Band | 10 V DC to 30 V DC or battery supply | IEC IP67; NEMA 6 | Inputs: Four 3-wire Pt100 RTDs Serial interface: RS-232 |
| DX80DR9M-H4E | | 10 V DC to 30 V DC or integrated battery | IEC IP65; NEMA 4X | |
| DX80DR2M-H4 | 2.4 GHz ISM Band | 10 V DC to 30 V DC or battery supply | IEC IP67; NEMA 6 | |
| DX80DR2M-H4E | | 10 V DC to 30 V DC or integrated battery | IEC IP65; NEMA 4X | |





DX80...C (IP20; NEMA 1) models are also available. To order this model with an IP20 housing, add a C to the end of the model number: DX80DR9M-H4C.

Integrated battery models are also available without batteries (add an -NB to the model number). If you purchase a model without the battery, Banner Engineering recommends battery mode BWA-BATT-001. For Class I Division 1/Zone 0 and Class I Division 2/Zone 2 environments, only battery BWA-BATT-001 is certified.

Configuration Instructions

Setting Up Your MultiHop Network

To set up and install your wireless MultiHop network, follow these steps:

1. If your radios have DIP switches, configure the DIP switches of all devices.
2. Connect the sensors to the MultiHop radios if applicable.
3. Apply power to all devices.
4. If your MultiHop radio has rotary dials, set the MultiHop Radio (Slave) ID. If your MultiHop radio has no rotary dials, continue to the next step.
5. Form the wireless network by binding the slave and repeater radios to the master radio. If the binding instructions are not included in this datasheet, refer to the quick start guide or product manual.
6. Observe the LED behavior to verify the devices are communicating with each other.
7. Configure any I/O points to use the sensors connected to the Sure Cross devices.
8. Conduct a site survey between the MultiHop radios. If the site survey instructions are not included in this datasheet, refer to the product manual.
9. Install your wireless sensor network components. If the installation instructions are not included in this datasheet, refer to the product manual.

For additional information, refer to one of the following documents:

- MultiHop Data Radio Quick Start Guide: [152653](#)
- MultiHop Data Radio Instruction Manual: [151317](#)
- MultiHop Register Guide: [155289](#)

Configure the DIP Switches

Before changing DIP switch positions, disconnect the power. For devices with batteries integrated into the housing, remove the battery(ies) for at least one minute to reboot the device. You may also triple-click button 2, then double-click button 2 to reset the device without removing the battery. Any changes made to the DIP switches are not recognized until after power is cycled to the device.

Access the Internal DIP Switches

Follow these steps to access the internal DIP switches.

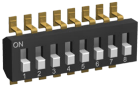

1. Unscrew the four screws that mount the cover to the bottom housing.
2. Remove the cover from the housing without damaging the ribbon cable or the pins the cable plugs into.
3. Gently unplug the ribbon cable from the board mounted into the bottom housing. For integrated battery models (no ribbon cable), C housing models (ribbon cable is glued down), and Class I, Division 2 certified devices (ribbon cable is glued down), skip this step.
4. Remove the black cover plate from the bottom of the device's cover.
The DIP switches are located behind the rotary dials.
5. Make the necessary changes to the DIP switches.
6. Place the black cover plate back into position and gently push into place.
7. If necessary, plug the ribbon cable in after verifying that the blocked hole lines up with the missing pin.
8. Mount the cover back onto the housing.

DIP Switch Settings (MultiHop)

| Device Settings | Switches | | | | | | | |
|---|------------------|------------------|------------------|------------------|---|---|---|---|
| | 1 | 2 | 3 | 4 | 5 | 6 | 7 | 8 |
| Serial line baud rate 19200 OR User defined receiver slots | OFF ¹ | OFF ¹ | | | | | | |
| Serial line baud rate 38400 OR 32 receiver slots | OFF | ON | | | | | | |
| Serial line baud rate 9600 OR 128 receiver slots | ON | OFF | | | | | | |
| Serial line baud rate Custom OR 4 receiver slots | ON ² | ON ² | | | | | | |
| Parity: None | | | OFF ¹ | OFF ¹ | | | | |
| Parity: Even | | | OFF | ON | | | | |
| Parity: Odd | | | ON | OFF | | | | |
| Disable serial (low power mode) and enable the receiver slots select for switches 1-2 | | | ON ² | ON ² | | | | |

| Device Settings | Switches | | | | | | | |
|---|----------|---|---|---|------------------|------------------|------------------|------------------|
| | 1 | 2 | 3 | 4 | 5 | 6 | 7 | 8 |
| Transmit power 900 MHz radios: 1.00 Watt (30 dBm) 2.4 GHz radios: 0.065 Watts (18 dBm) and 60 ms frame | | | | | OFF ¹ | | | |
| Transmit power 900 MHz radios: 0.25 Watts (24 dBm) 2.4 GHz radios: 0.065 Watts (18 dBm) and 40 ms frame | | | | | ON | | | |
| Application mode: Modbus | | | | | | OFF ¹ | | |
| Application mode: Transparent | | | | | | ON | | |
| MultiHop radio setting: Repeater | | | | | | | OFF ¹ | OFF ¹ |
| MultiHop radio setting: Master | | | | | | | OFF | ON |
| MultiHop radio setting: Slave | | | | | | | ON ² | OFF ² |
| MultiHop radio setting: Reserved | | | | | | | ON | ON |

¹ Default configuration

² Default configuration for the E housing models only

Application Mode

The MultiHop radio operates in either Modbus mode or transparent mode. Use the internal DIP switches to select the mode of operation. All MultiHop radios within a wireless network must be in the same mode.

Modbus mode uses the Modbus protocol for routing packets. In Modbus mode, a routing table is stored in each parent device to optimize the radio traffic. This allows for point to point communication in a multiple data radio network and acknowledgement/retry of radio packets. To access a radio's I/O, the radios must be running in Modbus mode.

In **transparent** application mode, all incoming packets are stored, then broadcast to all connected data radios. The data communication is packet based and not specific to any protocol. The application layer is responsible for data integrity. For one to one data radios it is possible to enable broadcast acknowledgement of the data packets to provide better throughput. In transparent mode, there is no access to the radio's I/O.

Baud Rate and Parity

The baud rate (bits per second) is the data transmission rate between the device and whatever it is physically wired to. Set the parity to match the parity of the device you are wired to.

Disable Serial

If the local serial connection is not needed, disable it to reduce the power consumption of a data radio powered from the solar assembly or from batteries. All radio communications remain operational.

Receiver Slots

The number of receiver slots indicates the number of times out of 128 slots/frames the radio can transmit to its parent radio. Setting a slave's receiver slots to 4 reduces the total power consumption by establishing that the slave can only transmit to its parent four times per 128 slots.

Transmit Power Levels/Frame Size

The 900 MHz data radios can be operated at 1 watt (30 dBm) or 0.250 watt (24 dBm). For most models, the default transmit power is 1 watt.

For 2.4 GHz radios, the transmit power is fixed at 0.065 watt (18 dBm) and DIP switch 5 is used to set the frame timing. The default position (OFF) sets the frame timing to 60 milliseconds. To increase throughput, set the frame timing to 40 milliseconds. Note that increasing the throughput decreases the battery life.

Prior to date code 15341 and radio firmware version 3.6, the frame timing was 40 ms (OFF) or 20 ms (ON).

Wire Your Sure Cross® Device

Use the following wiring diagrams to first wire the sensors and then apply power to the Sure Cross devices.

Wiring for RS-232 MultiHop Radios

Connecting power to the communication pins will cause permanent damage. For *FlexPower* devices, do not apply more than 5.5 V to the gray wire. The FlexPower MultiHop radios operate equally well when powered from the brown or gray wire; it is not necessary to supply both. The power for the sensors can be supplied by the radio's SPx terminals or from the 10 to 30 V dc used to power the radio.

| 5-pin M12/Euro-style Male Connector | Pin | Wire Color | Description |
|---|-----|------------|-----------------|
|  | 1 | Brown | 10 to 30 V dc |
| | 2 | White | RS-232 Tx |
| | 3 | Blue | dc common (GND) |
| | 4 | Black | RS-232 Rx |
| | 5 | Gray | 3.6 to 5.5 V dc |

Wiring for DX80...M-HxC RS-232 MultiHop Models

Connecting power to the communication pins will cause permanent damage. For *FlexPower* devices, do not apply more than 5.5 V to the gray wire. The FlexPower MultiHop radios operate equally well when powered from the brown or gray wire; it is not necessary to supply both. The power for the sensors can be supplied by the radio's SPx terminals or from the 10 V DC to 30 V DC used to power the radio.

| Label | Description | Label | Description |
|-------|--------------------|-------|----------------------|
| V+ | 10 V DC to 30 V DC | Rx | RS-232 Rx |
| Tx | RS-232 Tx | B+ | 3.6 V DC to 5.5 V DC |
| V- | dc common (GND) | | |

Wiring for DX80...E Radios

Connecting power to the communication pins will cause permanent damage. The integrated battery DX80...E radios may also be powered by 10 V DC to 30 V DC. The power for the sensors can be supplied by the radio's SPx terminals or from the 10 V DC to 30 V DC used to power the radio. The BAT connection is a low voltage connection to the internal battery. Remove the internal battery if a low voltage source is connected to the BAT terminal. When powering the device from the integrated battery, the BAT connection must remain open.

| | Integrated battery (RS-485) for P1E, M-H1E, M-H12E, and P16E Models | Integrated battery (RS-232) for P3E, P4E, M-H3E, and M-H4E Models |
|---|---|---|
|  | 1 10 V DC to 30 V DC (optional) | 10 V DC to 30 V DC (optional) |
| | 2 RS-485 / D1 / B / + | RS-232 Tx |
| | 3 dc common (GND) | dc common (GND) |
| | 4 RS-485 / D0 / A / - | RS-232 Rx |

Terminal Block (IP67 and C Housing)

For the DX8x...C models, PWR in the wiring diagram refers to V+ on the wiring board and GND in the wiring diagram refers to V- on the wiring board. Refer to the Class 1 Division 2/Zone 2 control drawings (p/n 143086) for wiring specifications and limitations.

| IP67 Housing | C Housing |
|--------------|-----------|
|--------------|-----------|

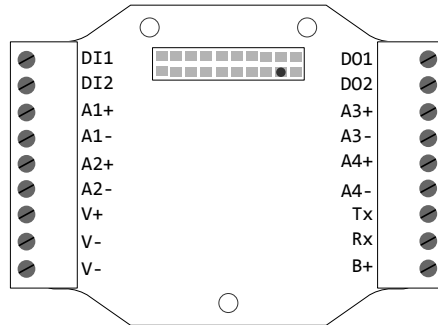
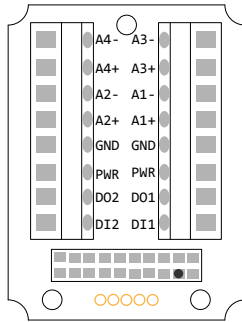

Ax+ and Ax-. Analog IN x. Analog inputs for devices requiring more than one connection, such as thermocouples or RTDs. When there is no Ax-, use Ax+ as an analog input.
 DIx. Discrete IN x
 DOx. Discrete OUT x
 GND. Ground/dc common connection
 PWR. 10 to 30 V dc power connection

B+. 3.6 to 5.5 V dc (use for battery powered models only)
 RX/-. Serial communication line for the Gateway. No connection for Nodes
 TX/+. Serial communication line for the Gateway; no connection for Nodes
 V+. 10 to 30 V dc power connection
 V-. Ground/dc common connection

Terminal Block (E Housing)

Refer to the Class 1 Division 2/Zone 2 control drawings (p/n 143086) for wiring specifications and limitations.

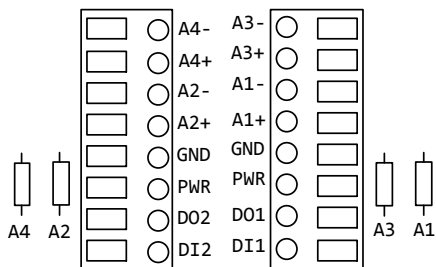

Ax+ and Ax-. Analog IN x. Analog inputs for devices requiring more than one connection, such as thermocouples or RTDs. When there is no Ax-, use Ax+ as an analog input.
 DIx. Discrete IN x
 DOx. Discrete OUT x
 GND. Ground/dc common connection
 PWR. 10 to 30 V dc power connection

Wiring Diagram for RTD Inputs

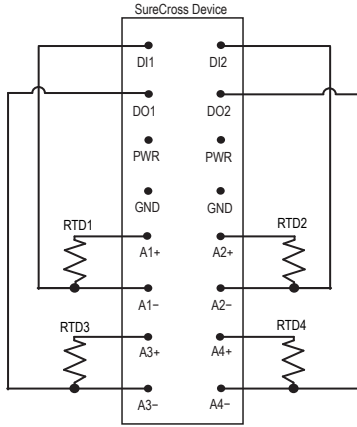

Set the MultiHop Radio (Slave) ID

On a MultiHop radio, use the rotary dials to set the device's MultiHop Radio ID.

Modbus Slave IDs 01 through 10 are reserved for slaves directly connected to the host (local I/O). Polling messages addressed to these devices are not relayed over the wireless link. Use Modbus Slave IDs 11 through 60 for MultiHop master, repeater, and slave radios. Up to 50 devices (local slaves and remote slaves) may be used in this system.

With the left dial acting as the left digit and the right dial acting as the right digit, the MultiHop Radio ID can be set from 01 through 60.



MultiHop Configuration Software

Use Banner's MultiHop Configuration Software to view your MultiHop radio network and configure the radio and its I/O.

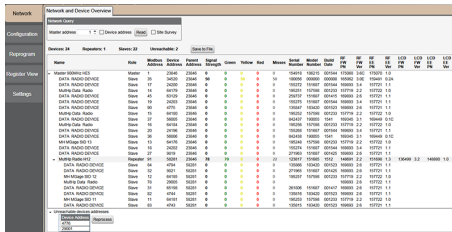

The software connects to a MultiHop master radio using one of four methods.

- Serial; using a USB to RS-485 (for RS-485 radios) or a USB to RS-232 (for RS-232 radios) converter cable.
- Modbus TCP; using an Ethernet connection to an Ethernet radio master.
- Serial DXM; using a USB cable to a DXM Controller to access a MultiHop master radio.
- TCP DXM; using an Ethernet connection to a DXM Controller to access a MultiHop master radio.

For MultiHop DX80DR* models, Banner recommends using BWA-UCT-900, an RS-485 to USB adapter cable with a wall plug that can power your 1 Watt MultiHop radio while you configure it. The adapter cable is not required when connecting to a DXM Controller.

Download the most recent software revision from the Wireless Reference Library on Banner Engineering's website: www.bannerengineering.com.

Installing Your Sure Cross® Radios

Please refer to one of the following instruction manuals for details about successfully installing your wireless network components.

- MultiHop Data Radio Instruction Manual: [151317](#)

Modbus Registers (High Resolution Mode)

| Register (4xxxx) | Input # | I/O Type | Units | I/O Range | | Terminals |
|------------------|---------|----------|-------|------------|------------|-----------|
| | | | | Min. Value | Max. Value | |
| 1 | 1 | | | | | |
| 2 | 2 | | | | | |
| 3 | 3 | RTD IN 1 | °F/°C | -1638.3 | +1638.4 | A1+/- |
| 4 | 4 | RTD IN 2 | °F/°C | -1638.3 | +1638.4 | A2+/- |
| 5 | 5 | RTD IN 3 | °F/°C | -1638.3 | +1638.4 | A3+/- |
| 6 | 6 | RTD IN 4 | °F/°C | -1638.3 | +1638.4 | A4+/- |

In low resolution mode, the minimum and maximum values are -16383 and +16384.

Modbus Addressing Convention

All Modbus addresses refer to Modbus holding registers. When writing your own Modbus scripts, use the appropriate commands for interfacing to holding registers. Parameter description headings refer to addresses in the range of 40000 as is customary with Modbus convention.

Modbus Register Configuration

Change the factory default settings for the inputs, outputs, and device operations using the device Modbus registers. To change parameters, set the data radio network to Modbus mode and assign the data radio a valid Modbus slave ID.

Generic input or output parameters are grouped together based on the device input or output number: input 1, input 2, output 1 etc. Operation type specific parameters (discrete, counter, analog 4 to 20 mA) are grouped together based on the I/O type number: analog 1, analog 2, counter 1, etc. Not all inputs or outputs may be available for all models. To determine which specific I/O is available on your model, refer to the Modbus Input/Output Register Maps listed in the device's datasheet. For more information about registers, refer to the MultiHop Product Manual (p/n 151317).

Storage and Sleep Modes

Storage Mode (applies to battery-powered models only)—While in **storage mode**, the radio does not operate. All Sure Cross® radios powered from an integrated battery ship from the factory in storage mode to conserve the battery. To wake the device, press and hold button 1 for 5 seconds. To put any *FlexPower*® or integrated battery Sure Cross radio into storage mode, press and hold button 1 for 5 seconds. The radio is in storage mode when the LEDs stop blinking, but in some models, the LCD remains on for an additional minute after the radio enters storage mode. After a device has entered storage mode, you must wait 1 minute before waking it.

Sleep Mode (applies to both battery and 10–30 V dc powered models)—During normal operation, the Sure Cross radio devices enter **sleep mode** after 15 minutes of operation. The radio continues to function, but the LCD goes blank. To wake the device, press any button.

Installing or Replacing the Battery (DX80...E Models)

To replace the lithium "D" cell battery or batteries in any integrated housing model, follow these steps.



CAUTION: There is a risk of explosion if the battery is replaced incorrectly.

1. Remove the four screws mounting the face plate to the housing and remove the face plate. Do not remove the radio cover from the face plate.
2. Remove the discharged battery or batteries.
3. Install the new battery or batteries, verifying the positive and negative terminals align to the positive and negative terminals of the battery holder mounted within the case.
4. After replacing the battery, allow up to 60 seconds for the device to power up.
5. Properly dispose of used batteries according to local regulations by taking it to a hazardous waste collection site, an e-waste disposal center, or other facility qualified to accept lithium batteries.

For outside or high humidity environments, dielectric grease may be applied to the battery terminals to prevent moisture and corrosion buildup.

As with all batteries, these are a fire, explosion, and severe burn hazard. Do not burn or expose them to high temperatures. Do not recharge, crush, disassemble, or expose the contents to water.

For non-hazardous locations, the replacement battery is model **BWA-BATT-011**. For non-hazardous or hazardous locations, the replacement battery is Xeno model XL-205F, Banner model **BWA-BATT-001**. For pricing and availability, contact Banner Engineering.



Specifications

MultiHop Radio Specifications

Radio Range[‡]

900 MHz, 1 Watt: Up to 9.6 km (6 miles)
2.4 GHz, 65 mW: Up to 3.2 km (2 miles)

Antenna Minimum Separation Distance

900 MHz, 150 mW and 250 mW: 2 m (6 ft)
900 MHz, 1 Watt: 4.57 m (15 ft)
2.4 GHz, 65 mW: 0.3 m (1 ft)

Radio Transmit Power

900 MHz, 1 Watt: 30 dBm (1 W) conducted (up to 36 dBm EIRP)
2.4 GHz, 65 mW: 18 dBm (65 mW) conducted, less than or equal to 20 dBm (100 mW) EIRP

Spread Spectrum Technology

FHSS (Frequency Hopping Spread Spectrum)

900 MHz Compliance (1 Watt)

FCC ID UE3RM1809: FCC Part 15, Subpart C, 15.247
IC: 7044A-RM1809

2.4 GHz Compliance (MultiHop)

FCC ID UE300DX80-2400: FCC Part 15, Subpart C, 15.247
RED Directive 2014/53/EU
IC: 7044A-DX8024

Antenna Connection

Ext. Reverse Polarity SMA, 50 Ohms
Max Tightening Torque: 0.45 N·m (4 lbf·in)

Radio Packet Size (MultiHop)

900 MHz: 175 bytes (85 Modbus registers)
2.4 GHz: 75 bytes (37 Modbus registers)

RS-232 Communication Specifications

Communication Hardware (MultiHop RS-232)

Interface: 2-wire RS-232
Baud rates: 9.6k, 19.2k (default), or 38.4k via DIP switches; 1200 and 2400 via the MultiHop Configuration Software
Data format: 8 data bits, no parity, 1 stop bit

[‡] Radio range is with the 2 dB antenna that ships with the product. High-gain antennas are available, but the range depends on the environment and line of sight. Always verify your wireless network's range by performing a Site Survey.

MultiHop H4 Specifications

Supply Voltage

M-Hx and "C" Housing Models: 10 V DC to 30 V DC (Outside the USA: 12 V DC to 24 V DC, ±10%) on the brown wire, or 3.6 V DC to 5.5 V DC low power option on the gray wire²
 "E" Housing Models: 3.6 V DC low power option from an internal battery or 10 V DC to 30 V DC

Power Consumption

Master radio consumption (900 MHz): Maximum current draw is < 100 mA and typical current draw is < 30 mA at 24 V DC. (2.4 GHz consumption is less.)
 Repeater/slave radio consumption (900 MHz): Maximum current draw is < 40 mA and typical current draw is < 20 mA at 24 V DC. (2.4 GHz consumption is less.)

RTD Inputs (MultiHop)

Sample Rate: 1 second
 Accuracy: 0.1% of full scale
 Resolution: 0.1 °C, 15-bit

Certifications for DX8x...C (External Wiring Terminal) and DX8x...E Models



CSA: Class I Division 2 Groups ABCD, Class I Zone 2 AEx/Ex nA II T4 — Certificate: 1921239



ATEX: II 3 G Ex nA IIC T4 Gc (Group IIC Zone 2) — Certificate LCIE 10 ATEX 1012 X

Refer to the Class I Division 2/Zone 2 control drawings (p/n 143086) for wiring specifications and limitations. Install the device in a suitable enclosure with provision for connection of Division 2 / Zone 2 wiring methods in accordance with local codes, as acceptable to the local inspection authority having jurisdiction. All battery-powered devices must only use the lithium battery manufactured by Xeno, model XL-205F (Banner model number BWA-BATT-001).

Certifications



(CE approval only applies to 2.4 GHz models)



(NOM approval only applies to 900 MHz models)



Housing

Polycarbonate housing and rotary dial cover; polyester labels; EDPM rubber cover gasket; nitrile rubber, non-sulphur cured button covers
 Weight: 0.26 kg (0.57 lbs)
 M-Hx and "C" Housing Models: Mounting: #10 or M5 (SS M5 hardware included)
 "E" Housing Models: Mounting: 1/4-inch or M7 (SS M7 hardware included)
 Max. Tightening Torque: 0.56 N·m (5 lbf·in)

Interface

Two bi-color LED indicators
 Two buttons
 Six character LCD

Wiring Access

M-Hx models: Four PG-7, One 1/2-inch NPT, One 5-pin threaded M12/Euro-style male quick disconnect
 "C" Housing Models: External terminals
 "E" Housing Models: Two 1/2-inch NPT

Required Overcurrent Protection



WARNING: Electrical connections must be made by qualified personnel in accordance with local and national electrical codes and regulations.

Overcurrent protection is required to be provided by end product application per the supplied table.
 Overcurrent protection may be provided with external fusing or via Current Limiting, Class 2 Power Supply.
 Supply wiring leads < 24 AWG shall not be spliced.
 For additional product support, go to www.bannerengineering.com.

| Supply Wiring (AWG) | Required Overcurrent Protection (Amps) |
|---------------------|--|
| 20 | 5.0 |
| 22 | 3.0 |
| 24 | 2.0 |
| 26 | 1.0 |
| 28 | 0.8 |
| 30 | 0.5 |

Included with the DX80 and DX80...C Models

- BWA-HW-002: DX80 Access Hardware Kit, containing four PG-7 plastic threaded plugs, four PG-7 nylon gland fittings, four PG-7 hex nuts, one 1/2-inch NPT plug, and one 1/2-inch nylon gland fitting. (Not included with IP20 DX80...C models)
- BWA-HW-001: Mounting Hardware Kit, containing four M5-0.8 x 25mm SS screws, four M5-0.8 x 16mm SS screws, four M5-0.8mm SS hex nuts, and four #8-32 x 3/4" SS bolts
- BWA-HW-003: PTFE tape
- BWA-902-C (900 MHz) or BWA-202-C (2.4 GHz): Antenna, 2 dBd Omni, Rubber Swivel RP-SMA Male. (Not included with Internal antenna models)
- MQDC1-506: 5-Euro (single ended) straight cable, 2m (Not included with FlexPower devices)
- BWA-HW-011: IP20 Screw Terminal Headers (2 pack) (Included only with the IP20 DX80...C models)
- Product datasheet and product family Quick Start Guide ([128185](#) for DX80 Gateways or [152653](#) for MultiHop models)

Environmental Specifications

Operating Conditions

-40 °C to +85 °C (-40 °F to +185 °F) (Electronics); -20 °C to +80 °C (-4 °F to +176 °F) (LCD)
 95% maximum relative humidity (non-condensing)
 Radiated Immunity: 10 V/m (EN 61000-4-3)

Shock and Vibration

IEC 68-2-6 and IEC 68-2-27
 Shock: 30g, 11 millisecond half sine wave, 18 shocks
 Vibration: 0.5 mm p-p, 10 to 60 Hz

Environmental Ratings

IEC IP67; NEMA 6
 Refer to the Sure Cross® MultiHop Product Instruction Manual (p/n [151317](#)) for installation and waterproofing instructions.

Operating the devices at the maximum operating conditions for extended periods can shorten the life of the device.

Environmental Specifications for the C Housings

Operating Conditions

-40 °C to +85 °C (-40 °F to +185 °F) (Electronics); -20 °C to +80 °C (-4 °F to +176 °F) (LCD)
 95% maximum relative humidity (non-condensing)
 Radiated Immunity: 10 V/m (EN 61000-4-3)

Shock and Vibration

IEC 68-2-6 and IEC 68-2-27
 Shock: 30g, 11 millisecond half sine wave, 18 shocks
 Vibration: 0.5 mm p-p, 10 to 60 Hz

Environmental Ratings

"C" Housing Models/External wiring terminals: IEC IP20; NEMA 1
 Refer to the Sure Cross® Wireless I/O Networks Instruction Manual (p/n [132607](#)) for installation and waterproofing instructions.

Operating the devices at the maximum operating conditions for extended periods can shorten the life of the device.

² For European applications, power this device from a Limited Power Source as defined in EN 60950-1.

Environmental Specifications for the E Housing

Operating Conditions

-40 °C to +85 °C (-40 °F to +185 °F) (Electronics); -20 °C to +80 °C (-4 °F to +176 °F) (LCD)
95% maximum relative humidity (non-condensing)
Radiated Immunity: 10 V/m (EN 61000-4-3)

Shock and Vibration

IEC 68-2-6 and IEC 68-2-27
Shock: 30g, 11 millisecond half sine wave, 18 shocks
Vibration: 0.5 mm p-p, 10 to 60 Hz

Environmental Ratings

IEC IP65
Refer to the Sure Cross® MultiHop Product Instruction Manual (p/n 151317) for installation and waterproofing instructions.

Operating the devices at the maximum operating conditions for extended periods can shorten the life of the device.

Included with the DX80..E Models

- Mounting hardware kit
- BWA-HW-003: PTFE tape
- BWA-902-C (900 MHz) or BWA-202-C (2.4 GHz): Antenna, 2 dBd Omni, Rubber Swivel RP-SMA Male. (Not included with Internal antenna models)
- BWA-BATT-001: Replacement battery, 3.6 Volt, "D" Lithium Cell
- BWA-HW-032: Access Hardware for "E" Housing (One each of 1/2-inch plug, 1/2-inch gland)
- Product datasheet and product family Quick Start Guide ([128185](#) for DX80 Gateways or [152653](#) for MultiHop models)

Warnings

Install and properly ground a qualified surge suppressor when installing a remote antenna system. Remote antenna configurations installed without surge suppressors invalidate the manufacturer's warranty. Keep the ground wire as short as possible and make all ground connections to a single-point ground system to ensure no ground loops are created. No surge suppressor can absorb all lightning strikes; do not touch the Sure Cross® device or any equipment connected to the Sure Cross device during a thunderstorm.

Exporting Sure Cross® Radios. It is our intent to fully comply with all national and regional regulations regarding radio frequency emissions. **Customers who want to re-export this product to a country other than that to which it was sold must ensure the device is approved in the destination country.** The Sure Cross wireless products were certified for use in these countries using the antenna that ships with the product. When using other antennas, verify you are not exceeding the transmit power levels allowed by local governing agencies. This device has been designed to operate with the antennas listed on Banner Engineering's website and having a maximum gain of 9 dBm. Antennas not included in this list or having a gain greater than 9 dBm are strictly prohibited for use with this device. The required antenna impedance is 50 ohms. To reduce potential radio interference to other users, the antenna type and its gain should be so chosen such that the equivalent isotropically radiated power (EIRP) is not more than that permitted for successful communication. Consult with Banner Engineering Corp. if the destination country is not on this list.

Banner Engineering Corp. Limited Warranty

Banner Engineering Corp. warrants its products to be free from defects in material and workmanship for one year following the date of shipment. Banner Engineering Corp. will repair or replace, free of charge, any product of its manufacture which, at the time it is returned to the factory, is found to have been defective during the warranty period. This warranty does not cover damage or liability for misuse, abuse, or the improper application or installation of the Banner product.

THIS LIMITED WARRANTY IS EXCLUSIVE AND IN LIEU OF ALL OTHER WARRANTIES WHETHER EXPRESS OR IMPLIED (INCLUDING, WITHOUT LIMITATION, ANY WARRANTY OF MERCHANTABILITY OR FITNESS FOR A PARTICULAR PURPOSE), AND WHETHER ARISING UNDER COURSE OF PERFORMANCE, COURSE OF DEALING OR TRADE USAGE.

This Warranty is exclusive and limited to repair or, at the discretion of Banner Engineering Corp., replacement. **IN NO EVENT SHALL BANNER ENGINEERING CORP. BE LIABLE TO BUYER OR ANY OTHER PERSON OR ENTITY FOR ANY EXTRA COSTS, EXPENSES, LOSSES, LOSS OF PROFITS, OR ANY INCIDENTAL, CONSEQUENTIAL OR SPECIAL DAMAGES RESULTING FROM ANY PRODUCT DEFECT OR FROM THE USE OR INABILITY TO USE THE PRODUCT, WHETHER ARISING IN CONTRACT OR WARRANTY, STATUTE, TORT, STRICT LIABILITY, NEGLIGENCE, OR OTHERWISE.**

Banner Engineering Corp. reserves the right to change, modify or improve the design of the product without assuming any obligations or liabilities relating to any product previously manufactured by Banner Engineering Corp. Any misuse, abuse, or improper application or installation of this product or use of the product for personal protection applications when the product is identified as not intended for such purposes will void the product warranty. Any modifications to this product without prior express approval by Banner Engineering Corp will void the product warranties. All specifications published in this document are subject to change; Banner reserves the right to modify product specifications or update documentation at any time. Specifications and product information in English supersede that which is provided in any other language. For the most recent version of any documentation, refer to: www.bannerengineering.com.

For patent information, see www.bannerengineering.com/patents.

Notas Adicionales

Información México: La operación de este equipo está sujeta a las siguientes dos condiciones: 1) es posible que este equipo o dispositivo no cause interferencia perjudicial y 2) este equipo debe aceptar cualquier interferencia, incluyendo la que pueda causar su operación no deseada.

Banner es una marca registrada de Banner Engineering Corp. y podrán ser utilizadas de manera indistinta para referirse al fabricante. "Este equipo ha sido diseñado para operar con las antenas tipo Omnidireccional para una ganancia máxima de antena de 6 dBd y Yagi para una ganancia máxima de antena 10 dBd que en seguida se enlistan. También se incluyen aquellas con aprobación ATEX tipo Omnidireccional siempre que no excedan una ganancia máxima de antena de 6dBd. El uso con este equipo de antenas no incluidas en esta lista o que tengan una ganancia mayor que 6 dBd en tipo omnidireccional y 10 dBd en tipo Yagi, quedan prohibidas. La impedancia requerida de la antena es de 50 ohms."

| Antenas SMA | Modelo | Antenas Tipo-N | Modelo |
|--|------------------|--|-------------------|
| Antena, Omni 902-928 MHz, 2 dBd, junta de caucho, RP-SMA Macho | BWA-902-C | Antena, Omni 902-928 MHz, 6 dBd, fibra de vidrio, 1800mm, N Hembra | BWA-906-A |
| Antena, Omni 902-928 MHz, 5 dBd, junta de caucho, RP-SMA Macho | BWA-905-C | Antena, Yagi, 900 MHz, 10 dBd, N Hembra | BWA-9Y10-A |

Mexican Importer

Banner Engineering de México, S. de R.L. de C.V.
David Alfaro Siqueiros 103 Piso 2 Valle oriente
San Pedro Garza García Nuevo León, C. P. 66269

81 8363.2714