



## Main

Range	TeSys
Product name	TeSys GV4
Device short name	GV4L
Product or component type	Circuit breaker
Device application	Motor protection
Poles description	3P
Utilisation category	Category A
Trip unit technology	Magnetic Electronic
Protection type	Short-circuit
[In] rated current	12.5 A
Breaking capacity	Icu 100 kA at 220...240 V AC 50/60 Hz conforming to IEC 60947-2 Icu 50 kA at 380...415 V AC 50/60 Hz conforming to IEC 60947-2 Icu 50 kA at 440 V AC 50/60 Hz conforming to IEC 60947-2 Icu 15 kA at 525 V AC 50/60 Hz conforming to IEC 60947-2 Icu 8 kA at 660...690 V AC 50/60 Hz conforming to IEC 60947-2 Icu 25 kA at 500 V AC 50/60 Hz conforming to IEC 60947-2
[Ics] rated service breaking capacity	100 kA at 220...240 V AC 50/60 Hz conforming to IEC 60947-2 50 kA at 380...415 V AC 50/60 Hz conforming to IEC 60947-2 50 kA at 440 V AC 50/60 Hz conforming to IEC 60947-2 25 kA at 500 V AC 50/60 Hz conforming to IEC 60947-2 15 kA at 525 V AC 50/60 Hz conforming to IEC 60947-2 2 kA at 660...690 V AC 50/60 Hz conforming to IEC 60947-2
Magnetic setting range	75...175 A
Control type	Rotary handle

## Complementary

[Ue] rated operational voltage	690 V AC 50/60 Hz conforming to IEC 60947-2
Motor power kW	3 kW at 400...415 V AC 50/60 Hz 3 kW at 500 V AC 50/60 Hz 4 kW at 500 V AC 50/60 Hz 5.5 kW at 660...690 V AC 50/60 Hz

	7.5 kW at 660...690 V AC 50/60 Hz 4 kW at 400...415 V AC 50/60 Hz 5.5 kW at 400...415 V AC 50/60 Hz 5.5 kW at 500 V AC 50/60 Hz 7.5 kW at 500 V AC 50/60 Hz 9 kW at 660...690 V AC 50/60 Hz 11 kW at 660...690 V AC 50/60 Hz
[Uimp] rated impulse withstand voltage	8 kV IEC 60947-2
[Ui] rated insulation voltage	800 V conforming to IEC 60947-2
Mounting mode	By clips By screws
Mounting support	35 mm symmetrical DIN rail Plate 75 mm symmetrical DIN rail
Suitability for isolation	Yes conforming to IEC 60947-1
Mechanical durability	40000 cycles
Electrical durability	40000 cycles for AC-3 at 440 V In/2 40000 cycles for AC-3 at 440 V In
Local signalling	Green indicatorpresence of auxiliary contacts:
Number of slots	1 slot(s) for alarm switch for fault signalling contact, plug-in 1 slot(s) for voltage release for electrical remote tripping, plug-in 1 slot(s) for auxiliary switch for open/close contact, plug-in
Toggle padlocking (with accessories)	Padlock in OFF or ON position
Connection pitch	27 mm
Connections - terminals	Top 1 EverLink BTR screw connectors wire size 1.5...70 mm <sup>2</sup> , solid Top 1 EverLink BTR screw connectors wire size 1.5...50 mm <sup>2</sup> , flexible Bottom 1 EverLink BTR screw connectors wire size 2.5...95 mm <sup>2</sup> , solid Bottom 1 EverLink BTR screw connectors wire size 2.5...70 mm <sup>2</sup> , flexible
Tightening torque	9 N.m for 16...95 mm <sup>2</sup> 5 N.m for 1.5...10 mm <sup>2</sup>
Wire stripping length	20 mm
Quality labels	CE
Standards	EN/IEC 60947-4-1 EN/IEC 60947-2
Height	155 mm
Width	81 mm
Depth	165 mm
Net weight	1.65 kg
Colour	Grey (RAL 7016)

## Environment

Product certifications	IEC CCC EAC EU-RO MR
Tropicalisation	2 conforming to IEC 68-2
IP degree of protection	IP40 front face conforming to IEC 60529
IK degree of protection	IK07 conforming to IEC 62262
Pollution degree	3 conforming to IEC 60947-1
Mechanical robustness	Vibrations: +/- 1 mm 2...13.2 Hz conforming to IEC 60068-2-6 Vibrations: 0.7 gn 13.2...100 Hz conforming to IEC 60068-2-6 Shocks: 15 gn 11 ms conforming to IEC 60068-2-27
Ambient air temperature for operation	-25...70 °C
Ambient air temperature for storage	-50...85 °C
Operating altitude	0...2000 m without derating 2000...5000 m with derating

## Offer Sustainability

Sustainable offer status	Green Premium product
--------------------------	-----------------------

EU RoHS Directive	Compliant <a href="#">EU RoHS Declaration</a>
Mercury free	Yes
RoHS exemption information	<a href="#">Yes</a>
China RoHS Regulation	<a href="#">China RoHS declaration</a> Product out of China RoHS scope. Substance declaration for your information
Environmental Disclosure	<a href="#">Product Environmental Profile</a>
Circularity Profile	<a href="#">End of Life Information</a>
WEEE	The product must be disposed on European Union markets following specific waste collection and never end up in rubbish bins

### Contractual warranty

Warranty	18 months
----------	-----------

Tripping Curves for GV4L and GV4LE Combined with Thermal Overload Relay LRD or LR9

Average Operating Times at 20 °C Related to Multiples of the Setting Current

GV4L02 and GV4LE02 to 12 with LRD05 to LRD14, GV4L80 and GV4LE80 with LRD3363

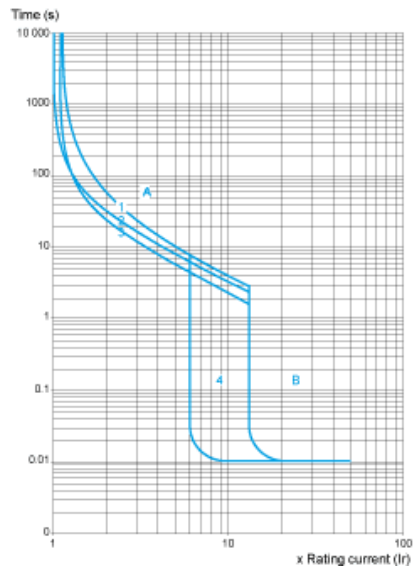

- 1 3 poles from cold state
- 2 2 poles from cold state
- 3 3 poles from hot state
- 4 6...14 Ir
- A Thermal overload relay protection zone
- B GV4L protection zone

GV4L25 and GV4LE25 with LRD 318, LRD325 GV4L50 AND GV4LE50 with LRD 332, LRD 340, LRD 350

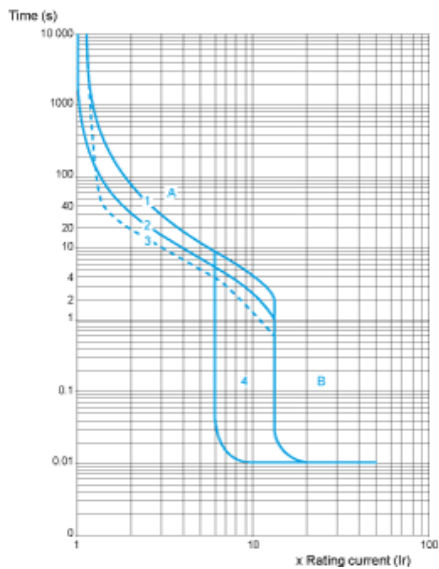

- 1 3 poles from cold state
- 2 2 poles from cold state
- 3 3 poles from hot state
- 4 6...14 Ir
- A Thermal overload relay protection zone
- B GV4L protection zone

GV4L115 and GV4LE115 with Class 10 LR9F5367, LR9D5369 and Class 20 LR9D5567, LR9F5569

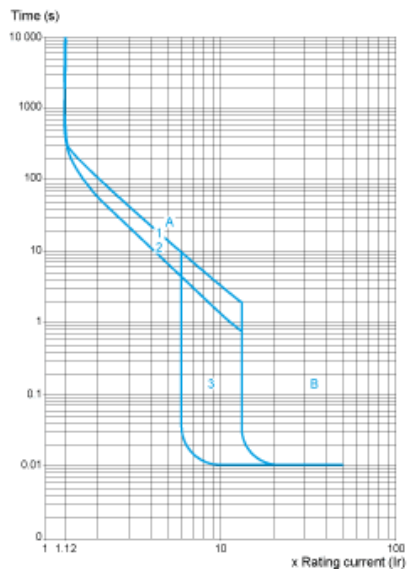

- 1 Cold state curve
- 2 Hot state curve
- 3 6...14 Ir

### Current Limitation on Short-Circuit for GV4L, GV4LE (3-Phase 400/415 V)

Dynamic Stress

$I_{peak} = f(\text{prospective } I_{sc}) \text{ at } 1.05 U_e = 435 \text{ V}$

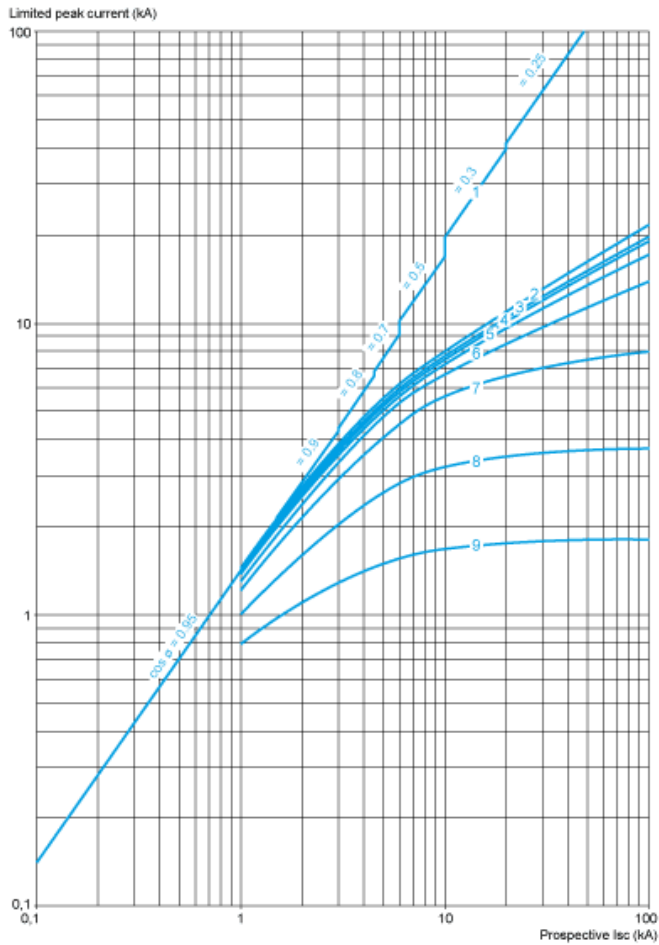

- 1 Maximum peak current
- 2 GV4L115
- 3 GV4L80
- 4 GV4L50
- 5 GV4L25
- 6 GV4L12
- 7 GV4L07
- 8 GV4L03
- 9 GV4L02

Current Limitation on Short-Circuit for GV4L, GV4LE + Thermal Overload Relay LRD or LR9 (3-Phase 400/415 V)

Dynamic Stress

$I_{peak} = f(\text{prospective } I_{sc}) \text{ at } 1.05 U_e = 435 \text{ V}$

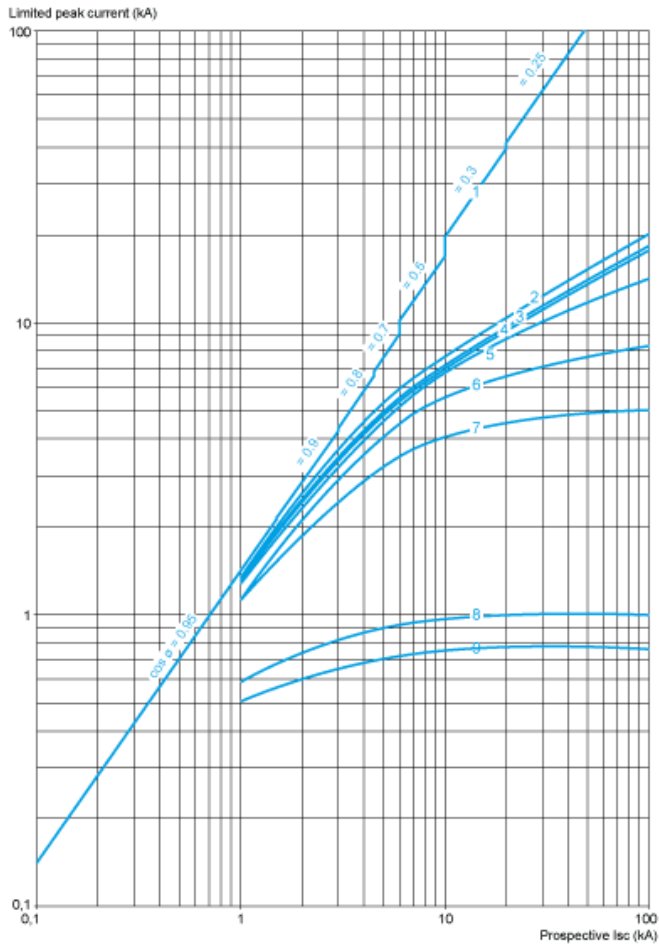

- 1 Maximum peak current
- 2 GV4L115 + LR9D5367 or LR9F5367
- 3 GV4L80 + LRD3361
- 4 GV4L50 + LRD340
- 5 GV4L25 + LRD325
- 6 GV4L12 + LRD313
- 7 GV4L07 + LRD12
- 8 GV4L03 + LRD07
- 9 GV4L02 + LRD07

### Thermal Limit on Short-Circuit for GV4L, GV4LE

Thermal Limit in A<sup>2</sup>s

Sum of  $I^2dt = f$  (prospective Isc) at 1.05 Ue = 435 V

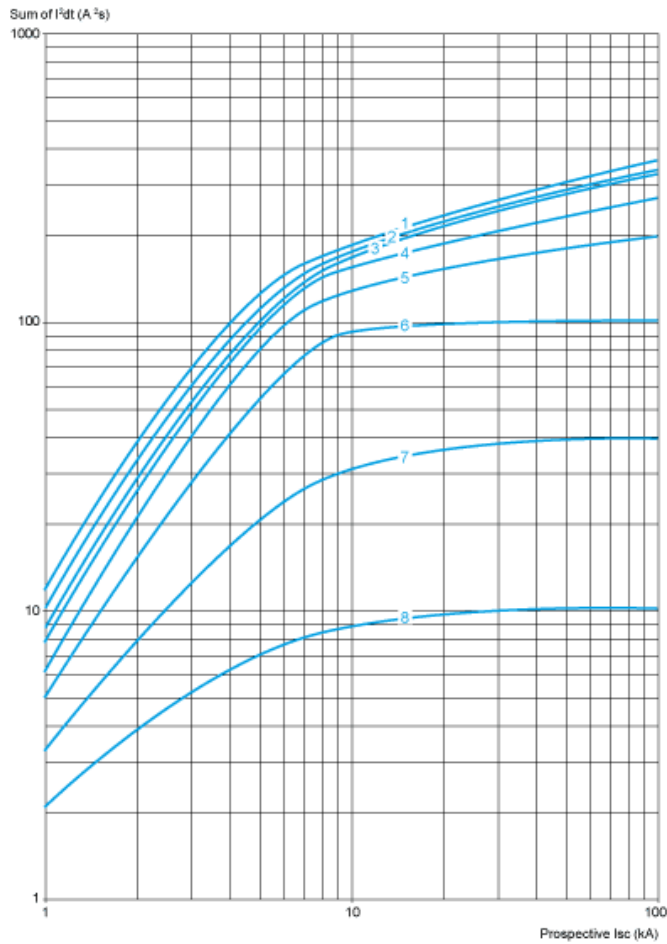

- 1 GV4L115
- 2 GV4L80
- 3 GV4L50
- 4 GV4L25
- 5 GV4L12
- 6 GV4L07
- 7 GV4L03
- 8 GV4L02

### Current Limitation on Short-Circuit for GV4L, GV4LE + Thermal Overload Relay LRD or LR9

Thermal Limit in kA in the Magnetic Operating Zone

Sum of  $I^2dt = f(\text{prospective Isc})$  at  $1.05 U_e = 435 \text{ V}$



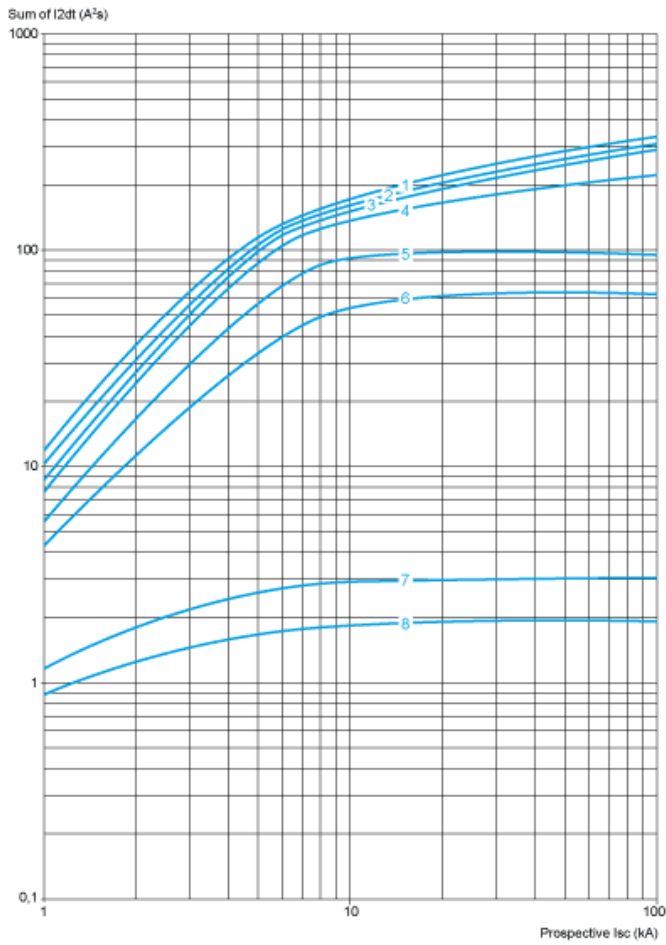

- 1 GV4L115 + LR9D5367 or LR9F5367
- 2 GV4L80 + LRD3361
- 3 GV4L50 + LRD340
- 4 GV4L25 + LRD325
- 5 GV4L12 + LRD313
- 6 GV4L07+ LRD12
- 7 GV4L03+ LRD07
- 8 GV4L02 + LRD07

GV4 with Toggle: GV4LE, GV4PE, GV4PEM

With EverLink® Connector

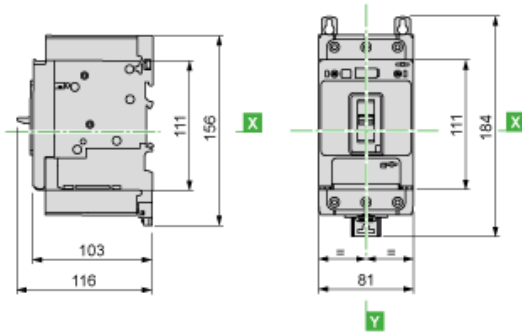

With Crimp Lug Connector

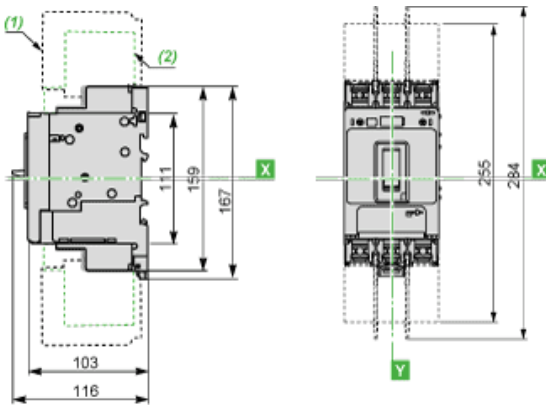

- (1) Interphases barriers
- (2) Long terminal shield

GV4 with Rotary Handle: GV4L, GV4P, or GV4LE, GV4PE, GV4PEM with GV4ADN01, GV4ADN02 Direct Mounting Rotary Handle

Dimensions

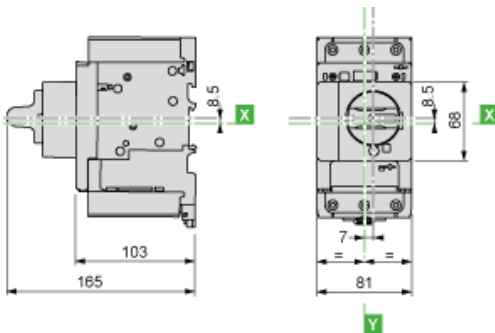

GV4L, GV4P, GV4LE, GV4PE, GV4PEM

Panel Mounting with M4 Screws

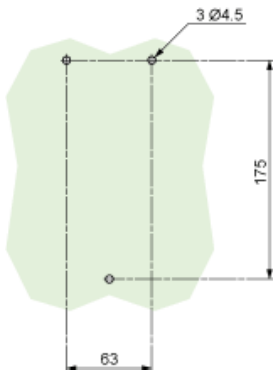

Door Cut-Out for Rotary Handle

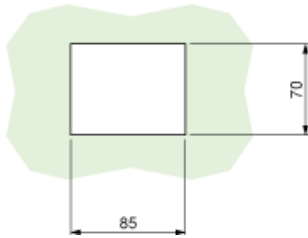

Minimum Safety Clearance

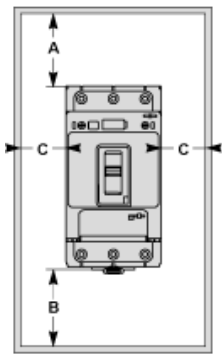

Toggle-type, rotary handle-type: identical clearance values.

Safety Clearance (mm)						
	Painted Sheet Metal			Bare Sheet Metal		
	A	B	C	A	B	C
No accessory	30	0	0	40	0	5
Interphase barriers	0	0	0	0	0	5
Long terminal shield	0	0	0	0	0	5

Magnetic Motor Circuit Breakers

GV4L, GV4LE

