



Part No. 1001435

Wi-Fi Dual Band On Ground / Off Ground Stamp Metal Antenna

2.4 / 5 GHz

Supports: Wi-Fi applications, Agriculture, Automotive, Bluetooth, Zigbee, WLAN, Smart Home, Healthcare, Digital Signage

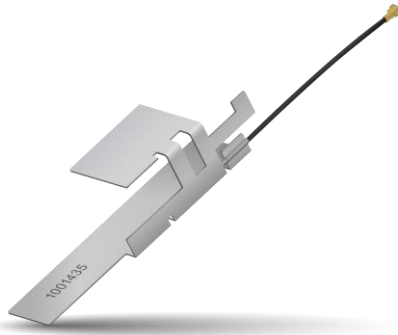

Ethertronics' antennas deliver on the key needs of device designers for higher functionality and performance in smaller/thinner designs. These innovative antennas provide compelling advantages for a 2.4 GHz and 5 GHz enabled handheld devices, media players and other mobile devices. Ethertronics' antennas requires a smaller design keep-out area and yields a quicker time-to-market without sacrificing RF performance.

Greater Flexibility

Ethertronics' first-in-class technology enables you to develop concept designs that are more advanced and that deliver superior performance in reception critical applications.

Wi-Fi Dual Band Stamp Metal Embedded Antenna

2.4 GHz; 5 GHz

KEY BENEFITS

Stay-in-Tune

Ethertronics antenna technology provides superior RF field containment, resulting in less interaction with surrounding components.

Quicker Time-to-Market

By optimizing antenna size, performance and emissions, customer and regulatory specifications are more easily met.

Reliability

Products are the latest RoHS version compliant

APPLICATIONS

- Embedded design
- Cellular, Headsets, Tablets
- Gateway, Access Point
- Handheld
- Telematics
- Tracking
- Healthcare
- M2M, Industrial devices
- Smart Grid
- OBD-II

Electrical Specifications

Typical Characteristics Free-space/ On Ground 150 x 150 mm PCB

Frequency	2400 – 2485 MHz		5150 – 5825 MHz	
Mounting	Off Ground	On Ground (Over Metal)	Off Ground	On Ground (Over Metal)
Peak Gain	4.2 dBi	4.7 dBi	6.4 dBi	6.0 dBi
Average Efficiency	82%	87%	80 %	75 %
VSWR Match	2:1 max			
Feed Point Impedance	50 ohms unbalanced			
Polarization	Linear			
Power Handling	0.5 Watt CW			

Mechanical Specifications & Ordering Part Number

Ordering Part Number	1001435
Size (mm)	41.1 x 14.6 x 9.5
Weight (grams)	1.55
Cable/Connector (mm)	Length: 70, Diameter: 1.13, Color: Black; u.FI compatible connector
Mounting	Drop-in or Adhesive on bottom (optional)

*Additional variations available with different cable lengths, colors and connectors.



2.4 / 5 GHz Ethertronics' Embedded Antenna Specifications
Ethertronics produces a wide variety of standard and custom antennas to meet user needs.

VSWR and Efficiency Plots (Off-Ground)

Typical Performance in Free-space

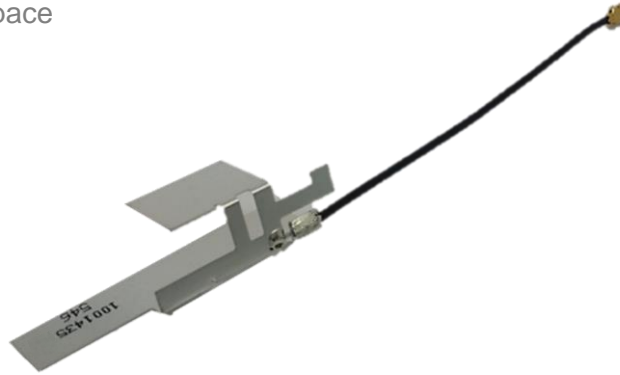

2.4 GHz VSWR

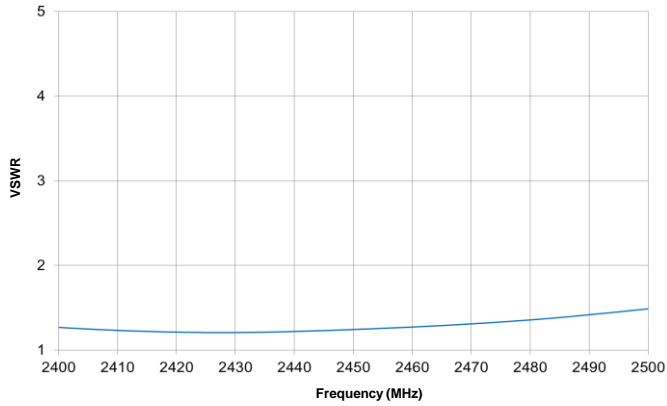

5 GHz VSWR

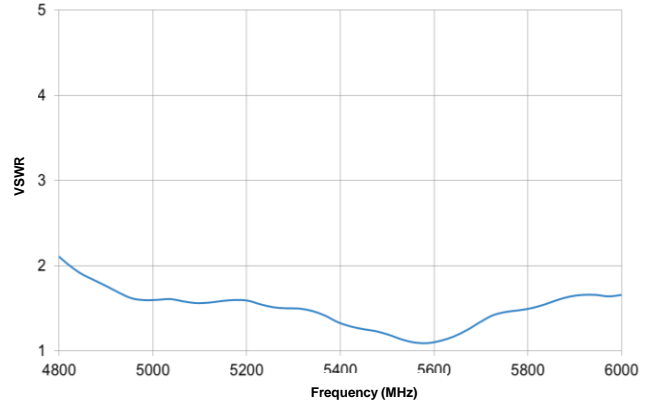

2.4 GHz Efficiency

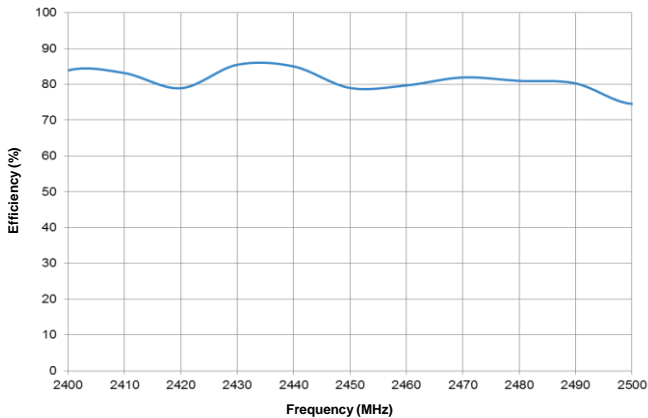

5 GHz Efficiency

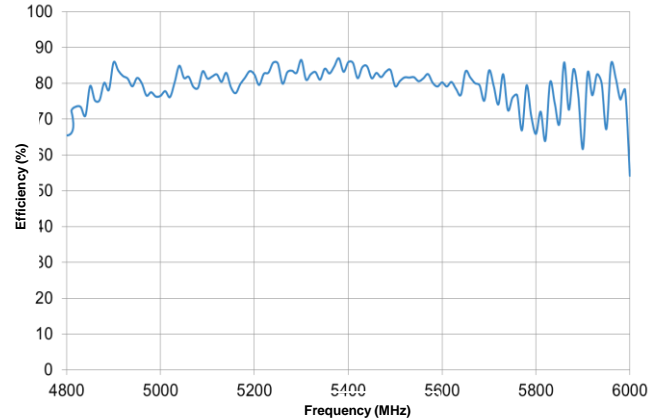



2.4 / 5 GHz Ethertronics' Embedded Antenna Specifications
Ethertronics produces a wide variety of standard and custom antennas to meet user needs.

Antenna Radiation Patterns (Off-Ground)

Typical Performance in Free-space

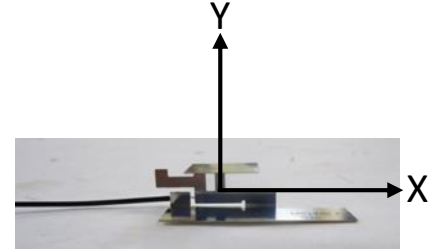
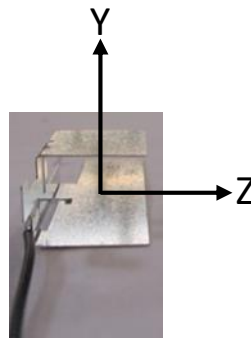
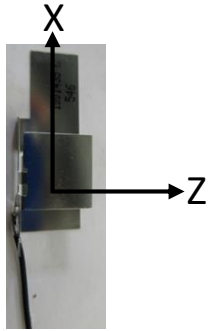

Measured at 2.45 GHz

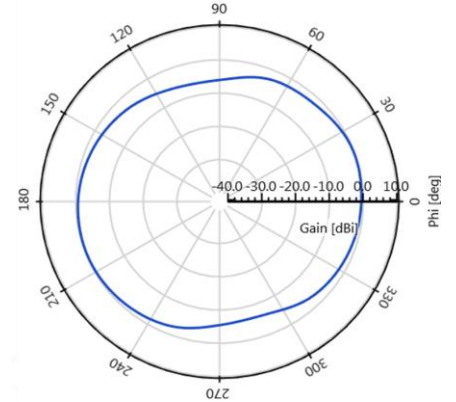
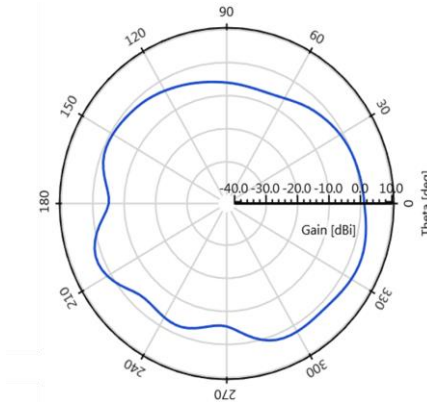
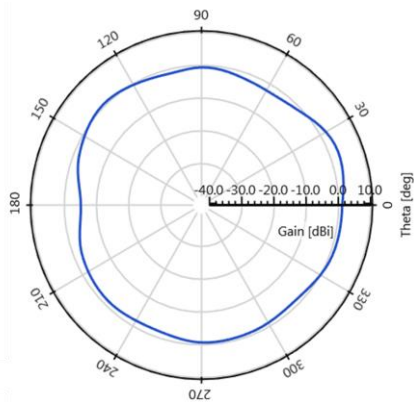

Measured at 5.4 GHz

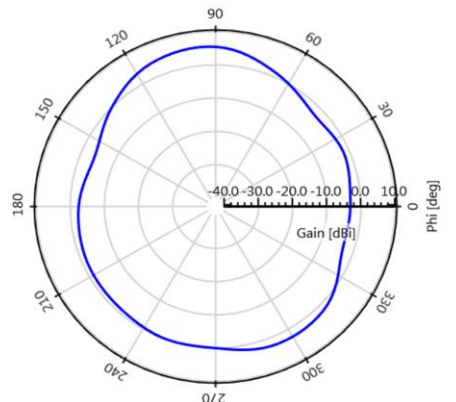
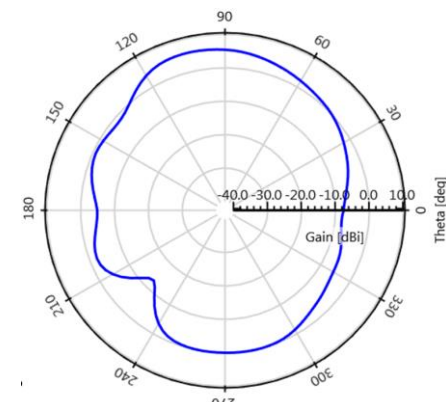
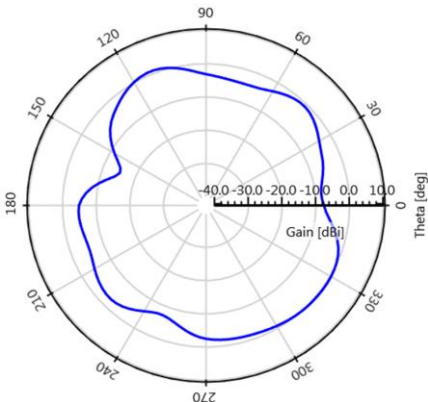



2.4 / 5 GHz Ethertronics' Embedded Antenna Specifications
Ethertronics produces a wide variety of standard and custom antennas to meet user needs.

VSWR and Efficiency Plots (On-Ground)

Typical performance on 150 x 150 mm PCB

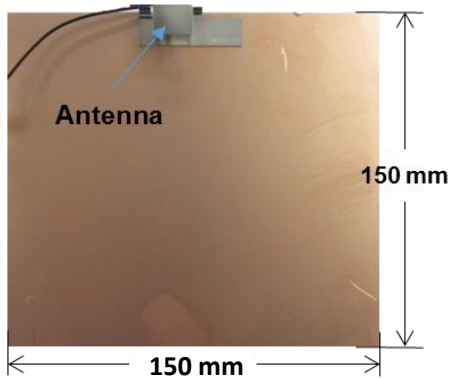

2.4 GHz VSWR

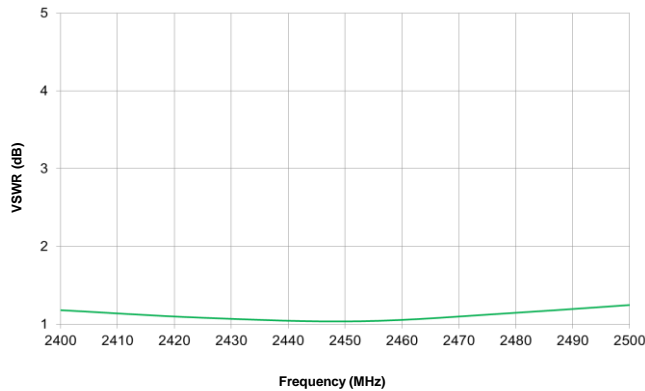

5 GHz VSWR

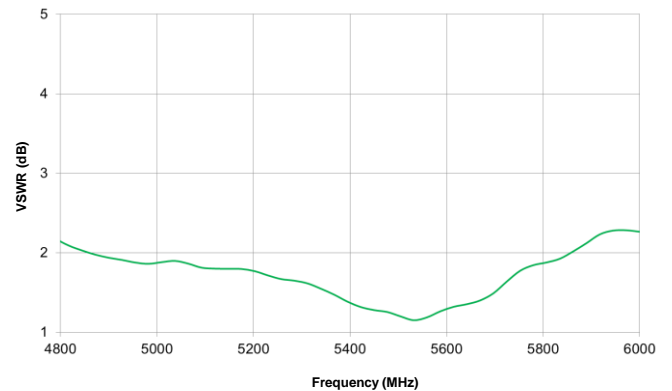

2.4 GHz Efficiency

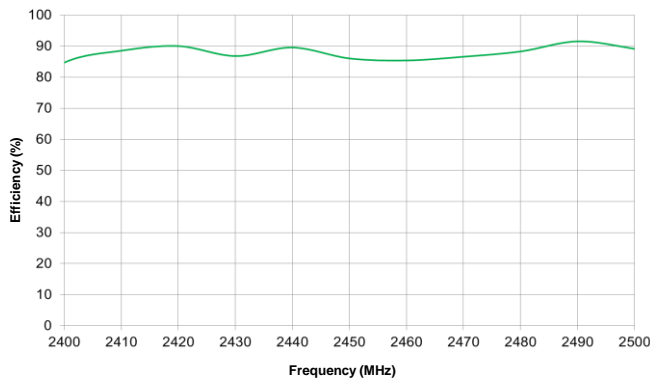

5 GHz Efficiency

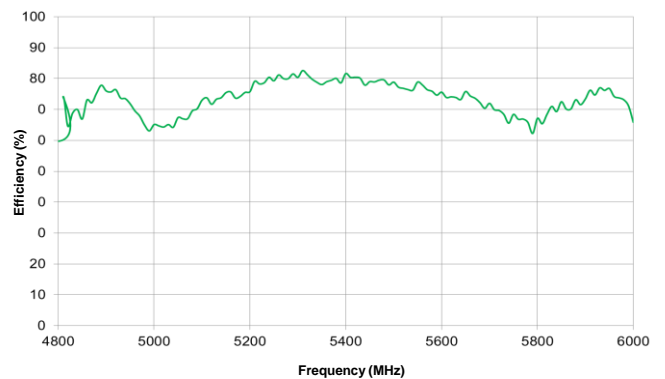



2.4 / 5 GHz Ethertronics' Embedded Antenna Specifications

Ethertronics produces a wide variety of standard and custom antennas to meet user needs.

Antenna Radiation Patterns (On-Ground)

Typical performance on 150 x 150 mm PCB

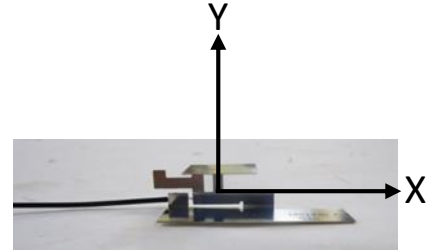
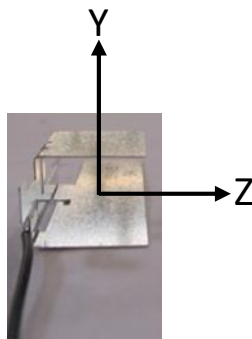
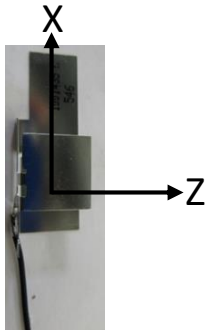

Measured at 2.45 GHz

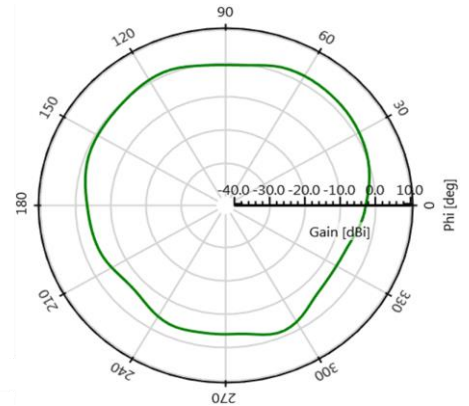
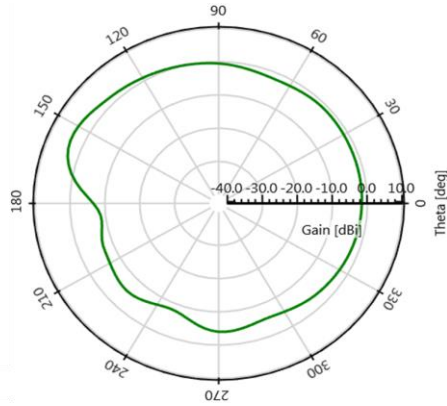
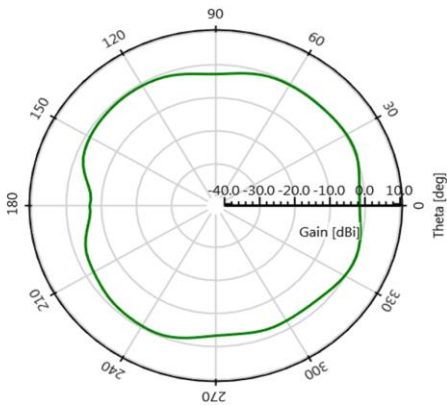

Measured at 5.4 GHz

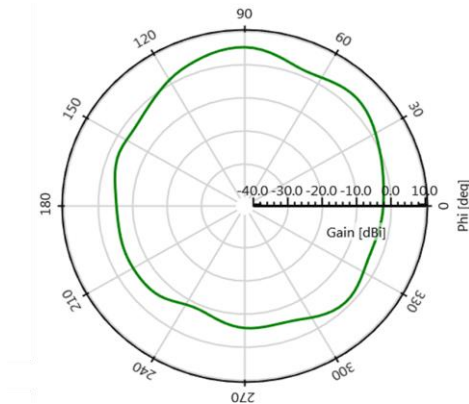
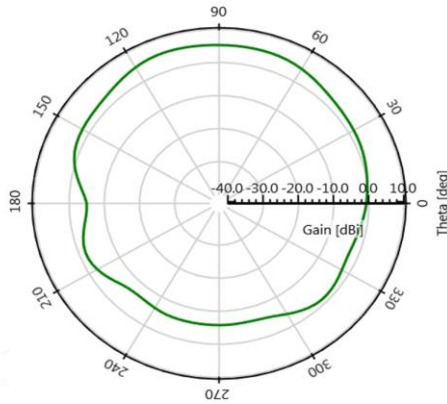
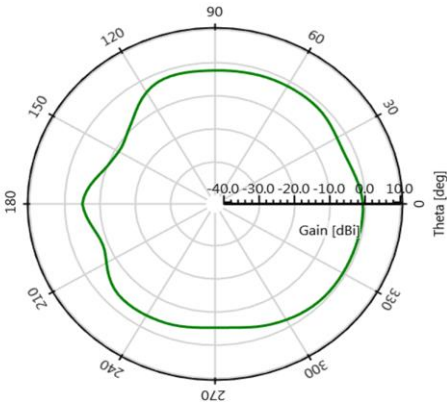



2.4 / 5 GHz Ethertronics' Embedded Antenna Specifications
Ethertronics produces a wide variety of standard and custom antennas to meet user needs.

Antenna Dimensions

Typical antenna dimensions, in mm.

Part Number	A (mm)	B (mm)	C (mm)
1001435	41.1 ± 0.3	14.6 max	9.5 ± 0.5

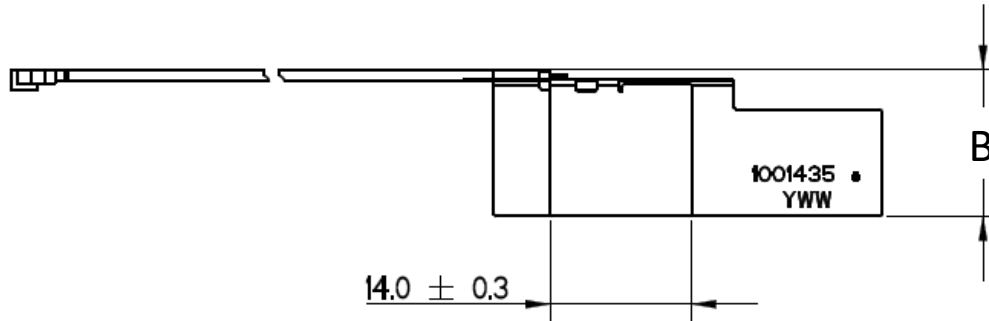

Top View

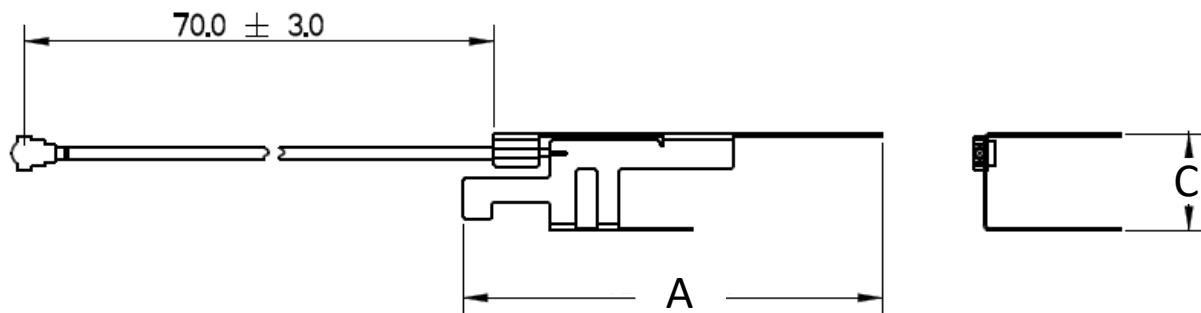

Side View

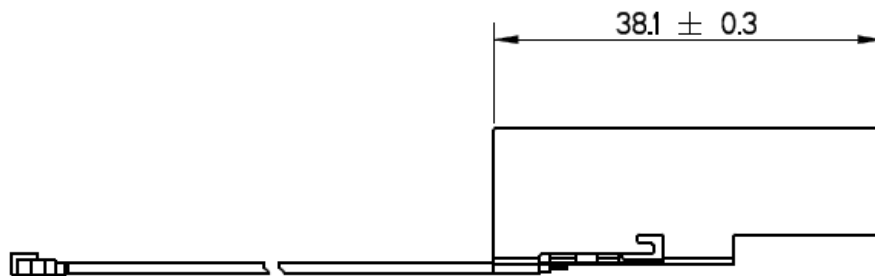

Bottom View