

HIGH TEMPERATURE
**DC POWER
JACKS & PLUGS**



Switchcraft[®]
CONXALL[®]

HARSH ENVIRONMENT CONNECTIVITY SOLUTIONS

New high temperature jacks and plugs from Switchcraft utilize a specially engineered, high RTI thermoplastic capable of withstanding much higher temperature and current than standard power jacks. This is ideal for applications with a high ambient temperature and is better able to withstand the high temperatures introduced by soldering than typical power jacks and plugs.

They are made in the USA using the same high quality components as our standard power jacks and plugs and are fully mateable with either high temperature or standard jacks and plugs from Switchcraft.

Temperature Limits: -40°C to +105° (-40°F to +221°F),

Current Rating at Maximum Operating Maximum Temperature Table:

Wire (AWG)	Maximum Current Rating (A) at Maximum Operating Temperature (°C)									Voltage Rating (VAC/DC)
	65°C	70°C	75°C	80°C	85°C	90°C	95°C	100°C	105°C	
16	10	9.5	9	8	7.5*	6.5	5.5	4	3	24
18	8.5	8	7.5	7	6.5*	5.5	4.5	3	2	
20	7.5	7	6.5	6	5*	4	3	1.5	1	

Note:

- *Temperature Rise does not exceed 30°C when tested according to UL2238. All other recommended current ratings are based on the Relative Thermal Index (RTI) of the insulating material.
- DC Power Plugs and Jacks are for current carry only. Switching the Power Jack on-off under resistive load is not recommended. The circuitry on-off switch should be off before connecting or disconnecting the Power Plug to Jack. For electrical life limitations under resistive load consult factory.

2.5MM CENTER PIN (SHORT BARREL)

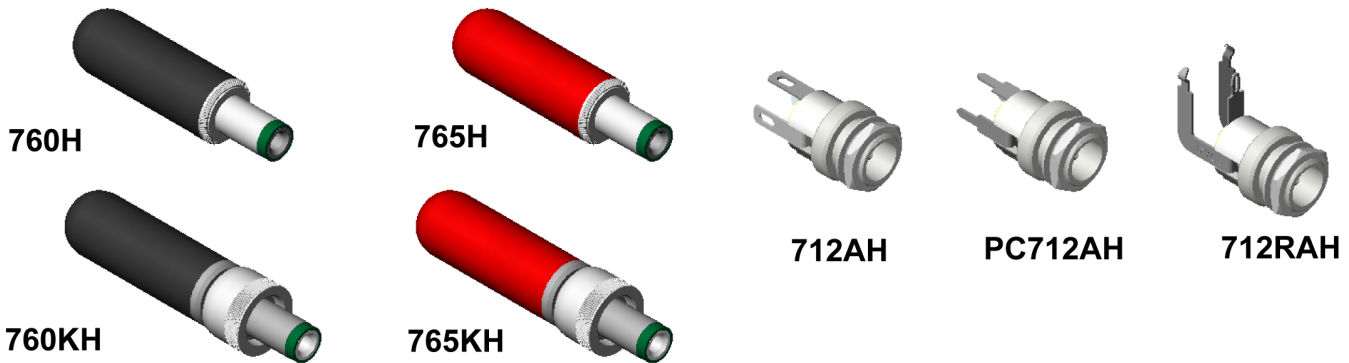

2.5MM CENTER PIN (LONG BARREL)

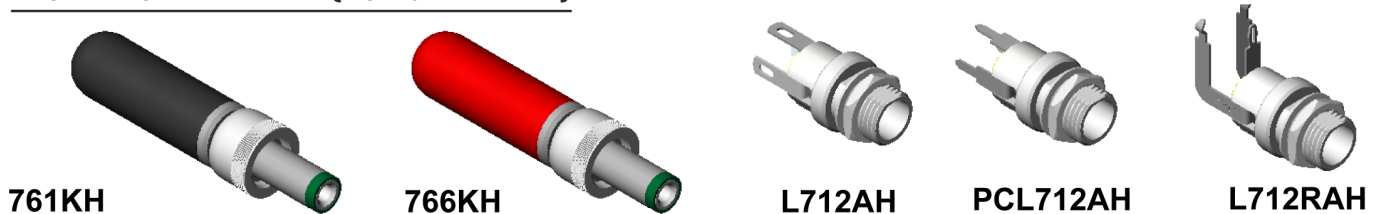

2.5MM CENTER PIN (SEALED)



761KSH12
761KSH15
761KSH17



L712ASH



PCL712ASH



L712RASH

2.0MM CENTER PIN (SHORT BARREL)

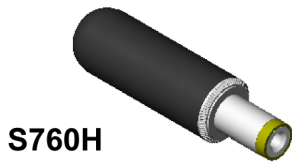

S760H

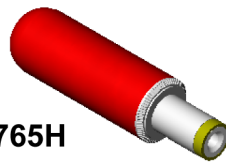

S765H



722AH



PC722AH

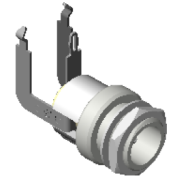

722RAH



S760KH

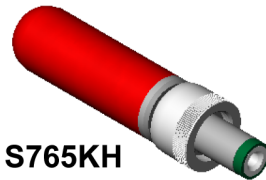

S765KH

2.0MM CENTER PIN (LONG BARREL)



S761KH

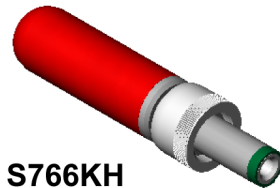

S766KH

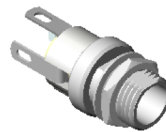

L722AH



PCL722AH

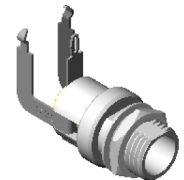

L722RAH

2.0MM CENTER PIN (SEALED)



S761KSH12
S761KSH15
S761KSH17



L722ASH



PCL722ASH



L722RASH

1.3MM CENTER PIN

STANDARD 860 & 865 PLUGS
(NO HIGH TEMPERATURE
1.3 mm PLUGS OFFERED)



732AH



PC732AH

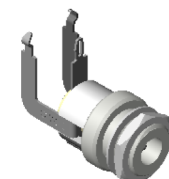

732RAH

SPECIFICATIONS

ELECTRICAL:

Voltage Rating:	24V DC resistive
Current Rating:	See current carry table on pg. 2
Insulation Resistance:	1,000 MΩ min.
Contact Resistance:	0.01Ω max. (initial) 0.02Ω max. (after humidity/ durability) 0.10Ω max. (after salt spray)
Dielectric Withstanding:	500 VAC max.

MATERIAL (JACKS):

Bushing:	Copper Alloy, nickel plated
Terminals:	Copper Alloy, silver plated
Hardware:	P2439 nickel plated copper alloy hex nut P2441 nickel plated steel flat washer
Electrical Insulator:	High RTI Thermoplastic, Phenolic
Contacts:	Copper Alloy, silver plated

MATERIAL (PLUGS):

Plug Sleeve and Pin:	Nickel-plated copper alloy.
Lock Ring:	Nickel-plated copper alloy.
Lock Ring Thread Size:	5/16 - 32 UNEF 2B.
Finger Insulator:	High RTI Thermoplastic
Insulating Washers:	Phenolic
Terminals:	Copper alloy, electro-tinned.
Handle:	High RTI Thermoplastic
Handle Thread Size:	5/16 - 24 UNF 2B.

MECHANICAL/ ENVIRONMENTAL:

Life:	5,000 insertion/withdrawal cycles min
Operating Forces:	3 pound maximum insertion 4 ounce minimum withdrawal
Temperature Limits:	-40°C to 105°C (-40°F to 221°F)