



EVQ3369-R-00A

6 Channels, Max.100mA/Ch Boost WLED Driver With 15000:1 Dim Ratio and I²C

DESCRIPTION

The MPQ3369 is a step-up converter with 6-channel current sources. It is designed for driving the white LED arrays as backlighting of middle or small size LCD panel.

The MPQ3369 uses peak-current mode as its PWM control architecture to regulate the boost converter. 6 channel current sources are applied into the LED cathode to adjust the LED brightness. It regulates the current in each LED string to the value set by an external current-setting resistor, with 2.5% current regulation accuracy between strings.

MPQ3369 employs a low on-resistor MOSFET and a low headroom voltage design to get the higher efficiency. It has standard I²C digital interface for easy use. The switching frequency can be programmed by a resistor, I²C interface or external clock.

MPQ3369 provides analog/PWM/mix dimming mode with PWM input. Dimming mode can be selected by I²C interface or MIX/AD pin. It also has the phase shift function to eliminate the noise when PWM dimming.

Rich protections are designed to guarantee safety operation. The protection modes include OCP (over-current protection), OVP (over-voltage protection), OTP (over-temperature protection), LED short and open protection. Besides, the LED current decreases automatically at higher temperature.

The MPQ3369 is available in QFN24-4mmX4mm and TSSOP28-EP package.

ELECTRICAL SPECIFICATIONS

Parameter	Symbol	Value	Units
Input Voltage	V _{IN}	12	V
Output Voltage	V _{LED}	<50	V
LEDs #		6 string	
LED Current /string	I _{LED}	50	mA

FEATURES

- 3.5V to 36V Input Voltage Range
- 6 Channels with Max. 100mA per Channel
- Internal 100mΩ, 50V MOSFET
- Programmable Up to 2.2MHz F_{sw}
- External Sync SW Function
- Multi-Dimming Operation Mode thru PWM input Including:
 1. Direct PWM Dimming
 2. Analog Dimming
 3. Mix Dimming with 25%/12.5% transfer point
- 15000:1 Dim Ratio in PWM Dim at F_{pwm}≤200Hz
- 200:1 Dim Ratio at Analog Dim thru PWM Dim Signal Input.
- Excellent EMI Performance, Frequency Spread Spectrum
- I²C Interface
- Phase Shift Function for PWM Dimming
- 2.5% Current Matching
- Cycle by Cycle Current Limit
- Disconnect V_{out} from V_{in}
- LED Current Auto Decrement at High Temperature
- LED Short/Open, OTP, OCP, Inductor Short Protection
- Programmable LED Short Threshold
- Programmable OVP Threshold
- Fault Indicator Signal Output
- QFN24-4mmX4mm and TSSOP28-EP Package

APPLICATIONS

- Tablet/Notebook
- Auto-motive Display

All MPS parts are lead-free, halogen-free, and adhere to the RoHS directive. For MPS green status, please visit the MPS website under Quality Assurance. "MPS", the MPS logo, and "Simple, Easy Solutions" are trademarks of Monolithic Power Systems, Inc. or its subsidiaries.

EVQ3369-R-00A EVALUATION BOARD

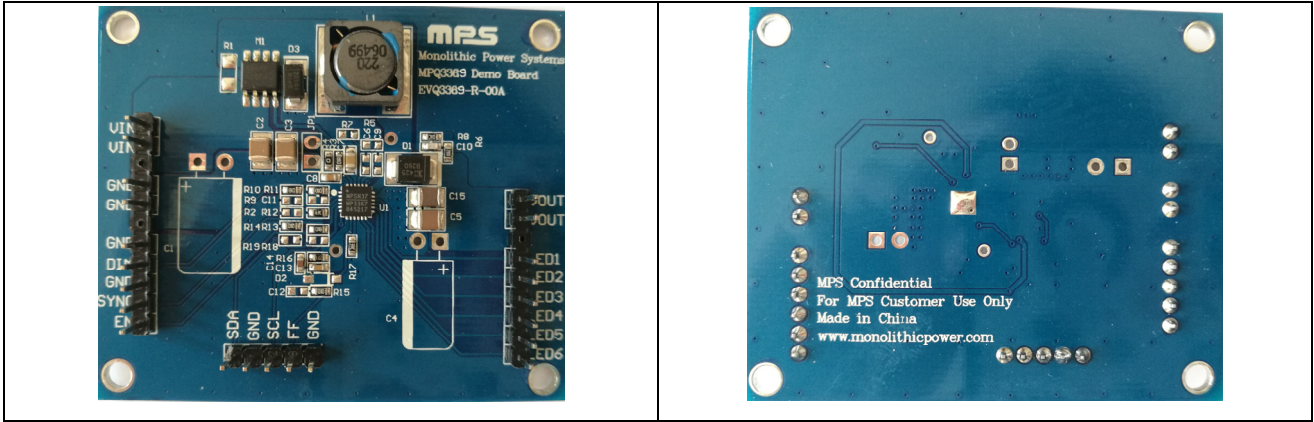

(L x W) 6.35cm x 5.25cm

Board Number	MPS IC Number
EVQ3369-R-00A	MPQ3369GR

EVALUATION BOARD SCHEMATIC

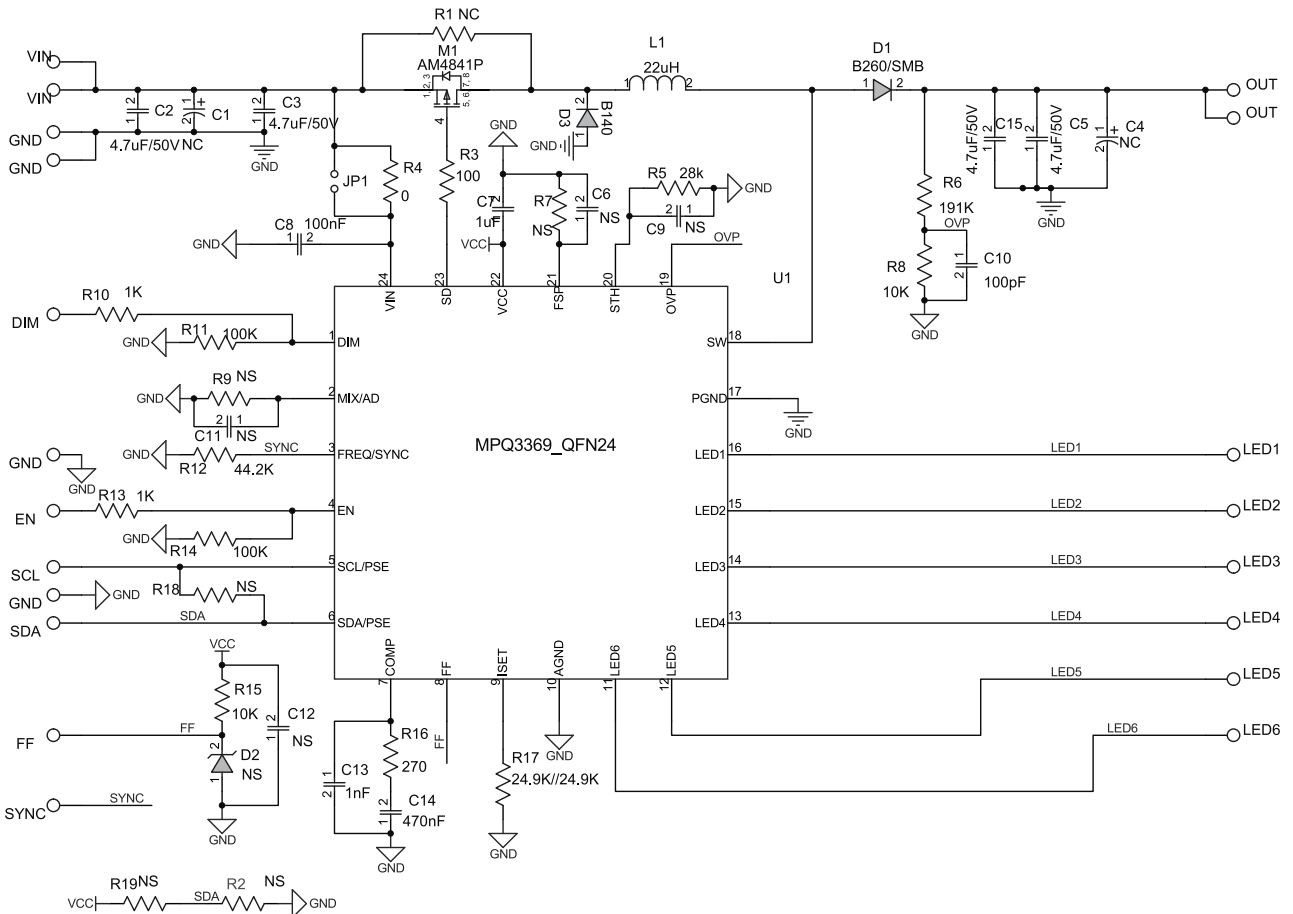

Typical Application for 6 Strings, 12 LED in series 50mA/string



EVQ3369-R-00A BILL OF MATERIALS

Qty	Ref	Value	Description	Package	Manufacturer	Part Number
1	C1	NC	Electrolytic Capacitor; 100µF/50V	DIP		
4	C2, C3, C5, C15	4.7µF/50V	Ceramic Capacitor; 50V;X7R;1210;	CAP/1210	muRata	GRM32ER71H475KA88L
1	C4	NC	Electrolytic Capacitor; 22µF/50V	DIP		
1	C7	1µF/25V	Ceramic Capacitor; 25V;X7R	CAP/0805	muRata	GRM216R61E105KA12D
1	C8	100nF/50V	Ceramic Capacitor; 50V;X7R	CAP/0603	TDK	C1608X7R1H104K
4	C6,C9, C11,C12	NC		CAP/0603		
1	C10	100pF/10V	Ceramic Capacitor; 50V;X7R	CAP/0603	muRata	GRM1885C1H101JA01D
1	C13	1nF/10V	Ceramic Capacitor; 16V;X7R	CAP/0603	muRata	GRM188R71102KA01D
1	C14	470nF/10V	Ceramic Capacitor; 16V;X7R	CAP/0603	TDK	C1608X7R1C474K
1	D1		Schottky Diode; 60V;2A;	DIODES /SMB	Diodes	B260
1	D2	NC	Zener Diode;3.3V	DIODES /SOD-123		
1	D3	WSCD24H	Schottky Diode; 40V;2A;	DIODES /SMA		WSCD24H
1	JP1	NC	Connector	CONN/DI P/2PIN/2. 54MM/A		
1	L1	22µH	Inductor;22µH;77.6m; Isat=3A	IND/TOK O/D104C- 919AS- 220M	TOKO	D104C-919AS-220M
1	M1	AM4841P	P-Channel Mosfet; -40V/9A	MOS/SO8	Analog Power	AM4841P
1	R1	NC	Film Resistor;5%;	RES/1206		
6	R2,R4,R 5,R7, R9,R18	NC	Film Resistor;1%;	RES/0603		
1	R3	100Ω	Film Resistor;1%;	RES/0603	Yageo	RC0603FR-07100RL
1	R4	0	Film Resistor;1%;	RES/0603	Yageo	RC0603FR-070RL
1	R6	191kΩ	Film Resistor;1%;	RES/0603	Yageo	RC0603FR-07191KL
1	R8	10kΩ	Film Resistor;1%;	RES/0603	Yageo	RC0603FR-0710KL
2	R10, R13	1kΩ	Film Resistor;1%;	RES/0603	Yageo	RC0603FR-071KL
3	R11, R14,R15	100kΩ	Film Resistor;1%;	RES/0603	Yageo	RC0603FR-07100KL
1	R12	44.2kΩ	Film Resistor;1%;	RES/0603	Yageo	RC0603FR-0744K2L
1	R16	270Ω	Film Resistor;1%;	RES/0603	Yageo	RC0603FR-07270RL
1	R17	24.9kΩ	Film Resistor;1%;	RES/0603	Yageo	RC0603FR-0724K9L
2	VIN	TP1, TP2	Connector;	CONN/TP		2.54mm 180 degree
1	LED6	TP19	Connector;	CONN/TP		
1	U1	MPQ3369		QFN24	MPS	MPQ3369

EVB TEST RESULTS

Performance waveforms are tested on the evaluation board.

$V_{IN} = 12V$, $L = 22\mu H$, LED=6P12S, $F_{SW}=400kHz$, $I_{SET}=50mA$, $T_A = 25^\circ C$, unless otherwise noted.

Steady State

$F_{SW}=400kHz$

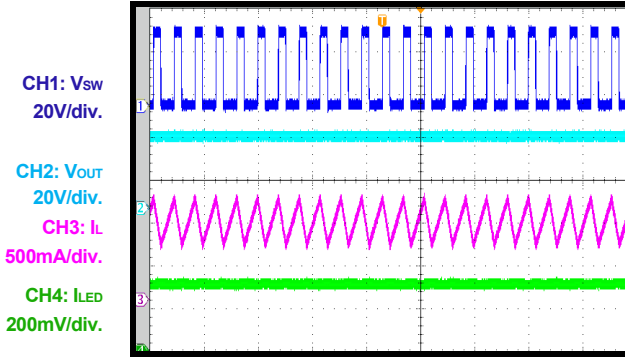

4µs/div.

Steady State

$F_{SW}=2.2MHz$

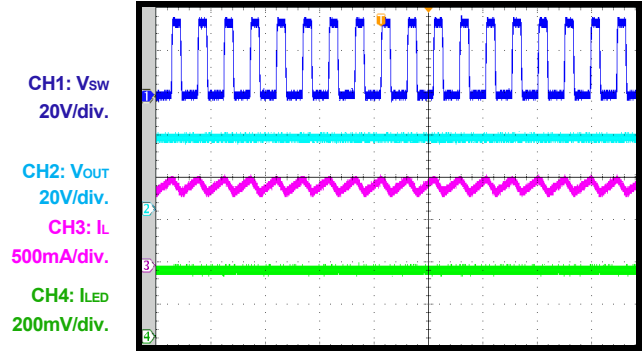

1µs/div.

VIN Power On

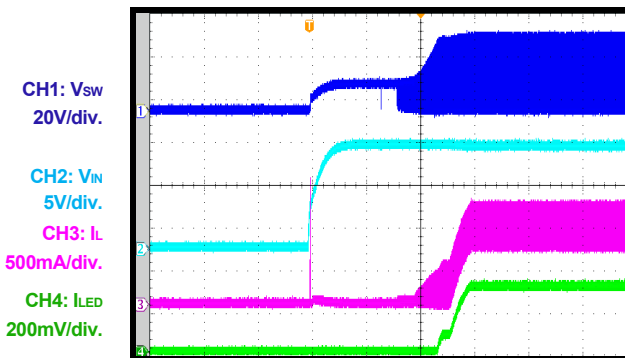

10ms/div.

EN Power On

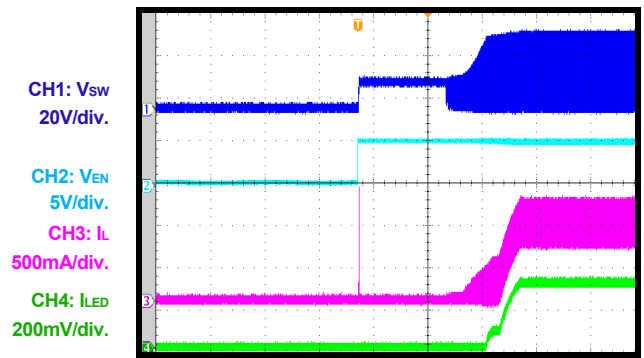

10ms/div.

PWM Dimming

$F_{PWM}=200Hz$, $D_{PWM}=50\%$

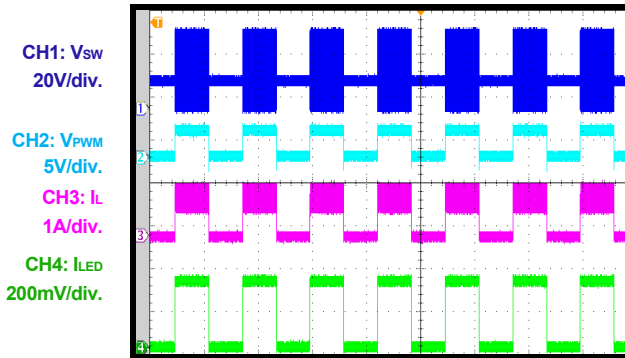

4ms/div.

PWM Dimming

$F_{PWM}=20kHz$, $D_{PWM}=50\%$

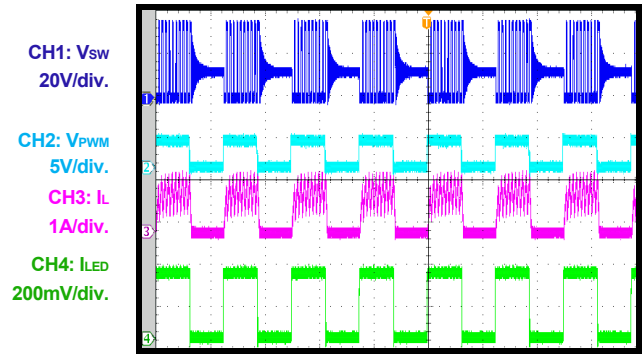

40µs/div.

EVB TEST RESULTS *(continued)*

Performance waveforms are tested on the evaluation board.

$V_{IN} = 12V$, $L = 22\mu H$, $LED=6P12S$, $F_{SW}=400kHz$, $I_{SET}=50mA$, $T_A = 25^\circ C$, unless otherwise noted.

PWM Dimming
 $F_{PWM}=200Hz$, $D_{PWM}=0.01\%$

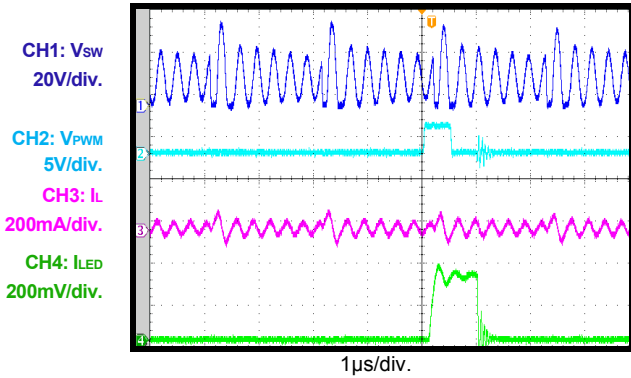

PWM Dimming
 $F_{PWM}=200Hz$, $D_{PWM}=0.001\%$

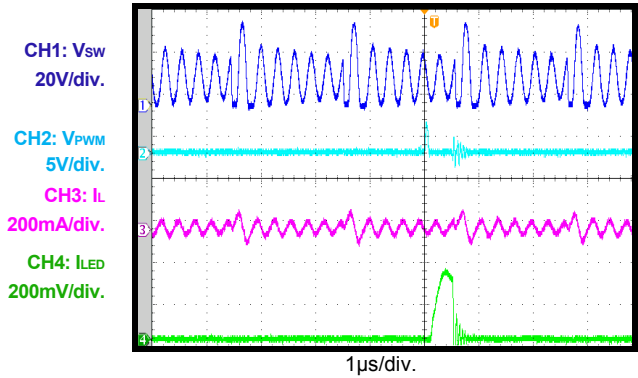

Mix Dimming
 $F_{PWM}=F_{(LED)}=200Hz$, $D_{PWM}=10\%$

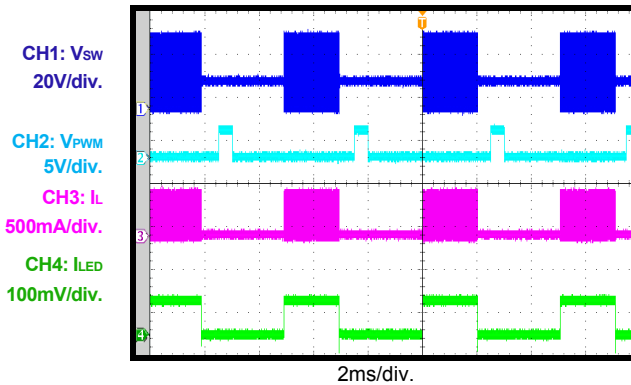

Mix Dimming
 $F_{PWM}=200Hz$, $F_{LED}=23kHz$, $D_{PWM}=10\%$

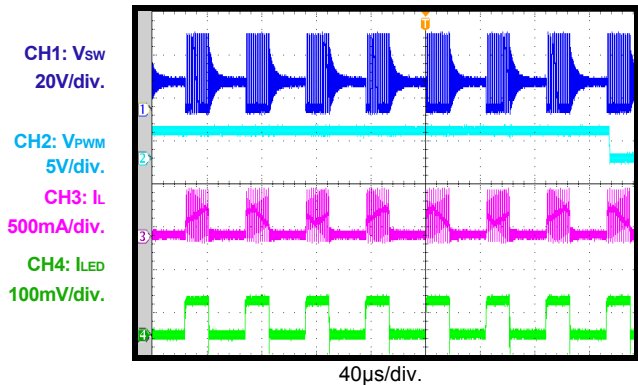

Phase Shift Function
 $F_{PWM}=200Hz$, PWM Dimming, 6 Channel Enable

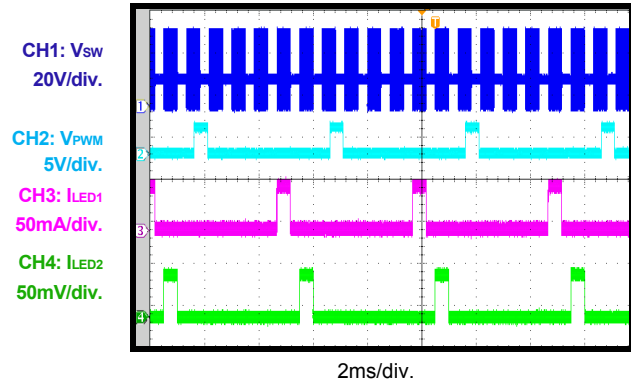

Frequency Spread Spectrum
 $F_{PWM}=400Hz$, 1/100 of Center Frequency

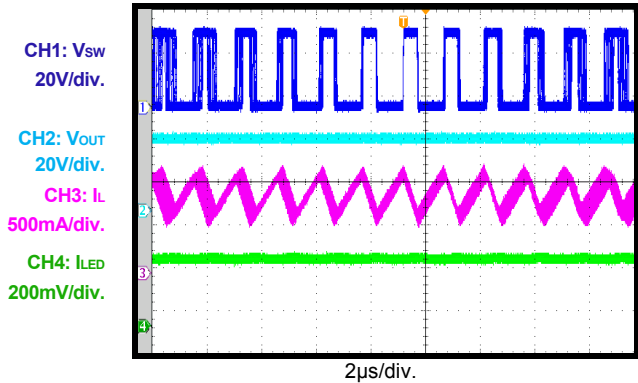

EVB TEST RESULTS (continued)

Performance waveforms are tested on the evaluation board.

$V_{IN} = 12V$, $L = 22\mu H$, $LED=6P12S$, $F_{SW}=400kHz$, $I_{SET}=50mA$, $T_A = 25^\circ C$, unless otherwise noted.

Open LED Protection
Open One String @ Working

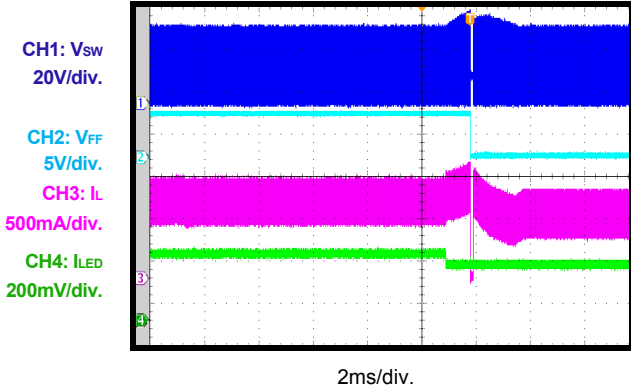

Short LED Protection
Short One String @ Working

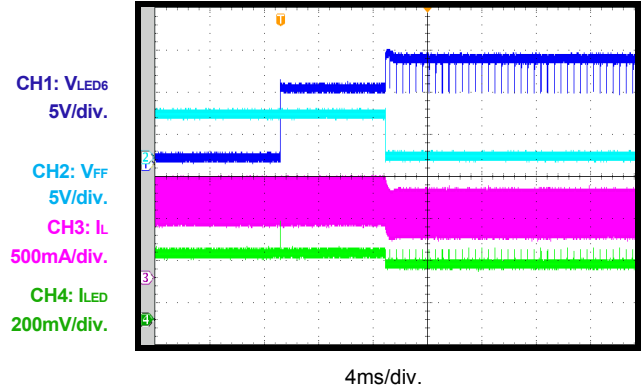

Short Inductor Protection

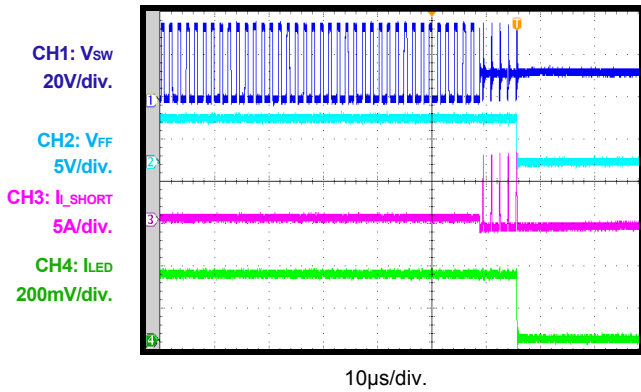

Short Diode Protection

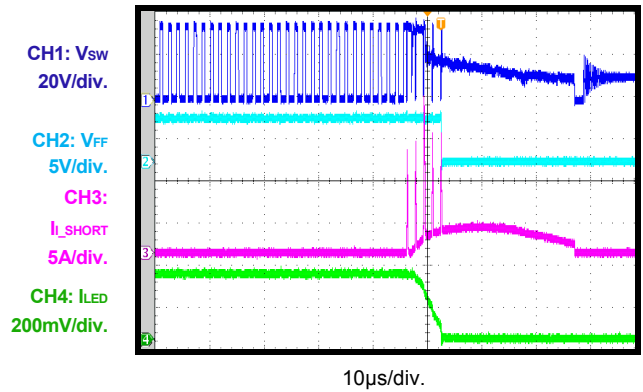

Short VOUT to GND Protection

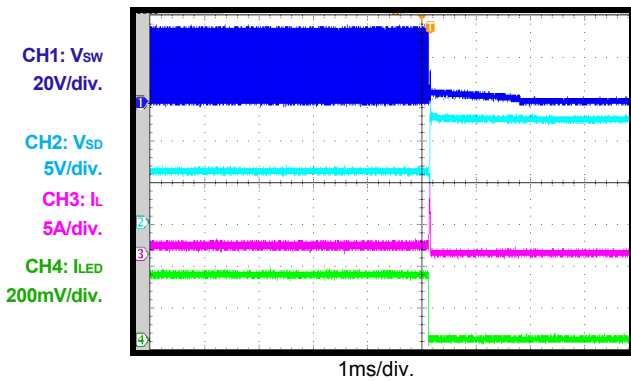

Thermal Shutdown Protection
 $F_{PWM}=400Hz$, 1/100 of Center Frequency

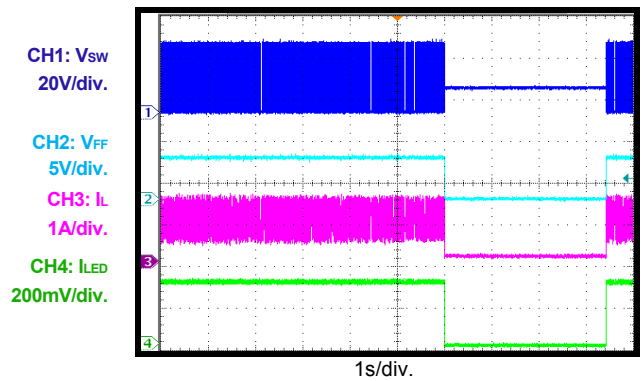

PRINTED CIRCUIT BOARD LAYOUT

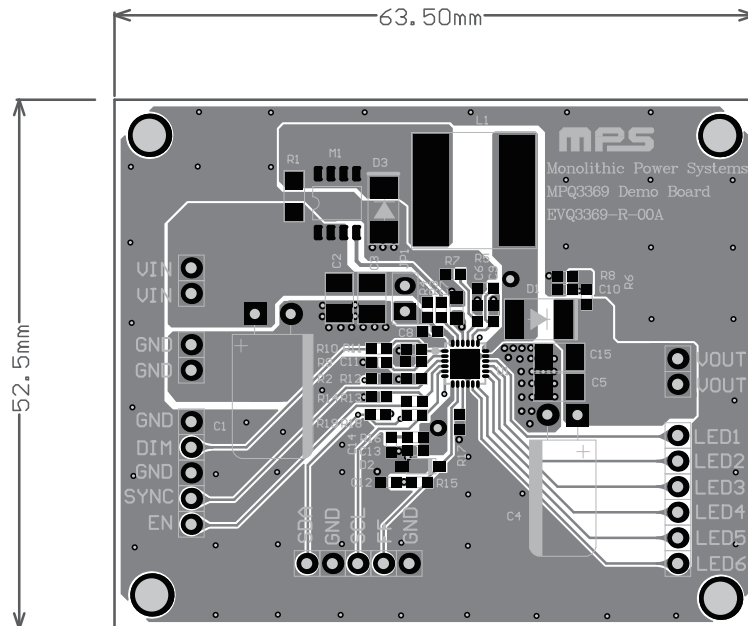

Figure 1: Top Layer

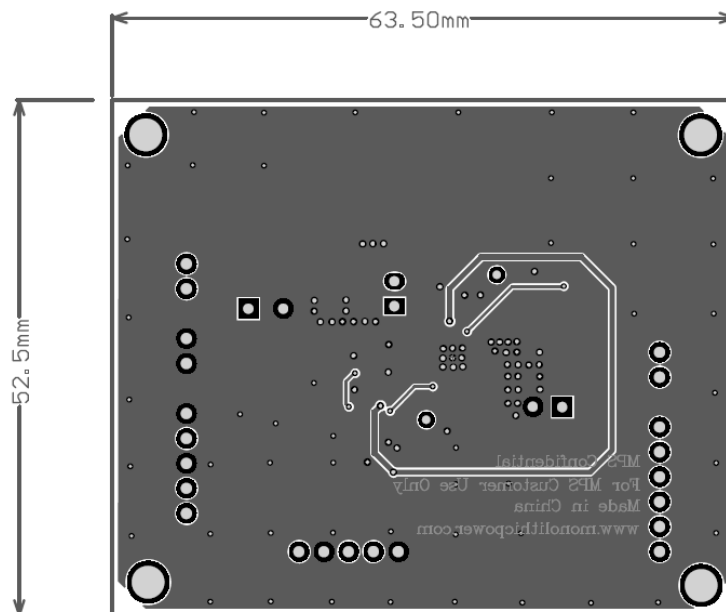

Figure 2: Bottom Layer

QUICK START GUIDE

1. Provide a voltage source ranges from 3.5-36V between VIN terminal and GND on the EV board.
2. Connect the positive and negative terminals of the LED load (6 strings) to the LED+ and LED1~6 pins on the EV board, respectively.
3. Drive EN pin high to enable the MPQ3369.
4. 100Hz~20kHz PWM pulse is added to the PWM terminal.
5. Please connect SCL, SDA and GND of EV board to SCL, SDA and GND of a I2C kit respectively.
6. Write and read the Registers.

Firstly, check that the I2C kit communicate with the computer normally. When the text "USB is unconnect" appear on the GUI, it indicates the I2C kit can not communicate the computer. Otherwise, the communication is OK.

Second, click the button to select the parameter.

Lastly, when users finish the parameter setting, send the data to IC until click the button "WRITE ALL".

User can also check the data is written to IC by click the button "READ ALL".

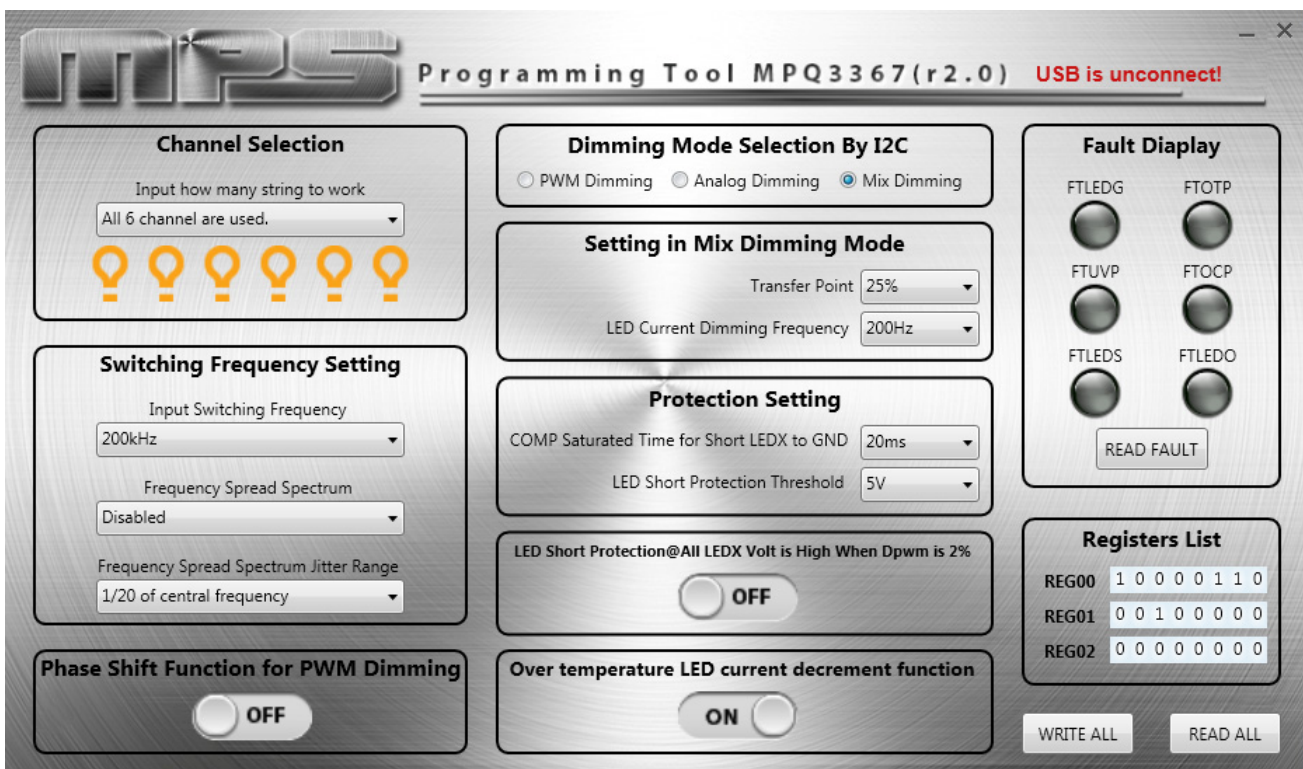

NOTICE: The information in this document is subject to change without notice. Please contact MPS for current specifications. Users should warrant and guarantee that third party Intellectual Property rights are not infringed upon when integrating MPS products into any application. MPS will not assume any legal responsibility for any said applications.