

T266 Axial MIL-PRF-39003/11 Space Grade (CSS21 Style)

Overview

The T266 Capacitor (CSS21 Style) is qualified to MIL-PRF-39003/11. Similar to KEMET's T216 and T256 (MIL-PRF-39003/10; CSS13 and CSS33), the T266 is designed for use in harsh environments such as space applications or other equally demanding environments.

Applications

These capacitors provide circuit designers an excellent choice for blocking, bypass, decoupling, filtering, and timing applications.

Benefits

- Taped and reeled per EIA Specification RS-296
- Marking per MIL-STD-1285
- Qualified to MIL-PRF-39003, Style CSS21
- Low ESR
- Failure rate graded options: B, C
- Case sizes: C and D
- Operating temperature range of -55°C to +125°C
- Surge current tested at -55°C and +85°C (10 cycles)

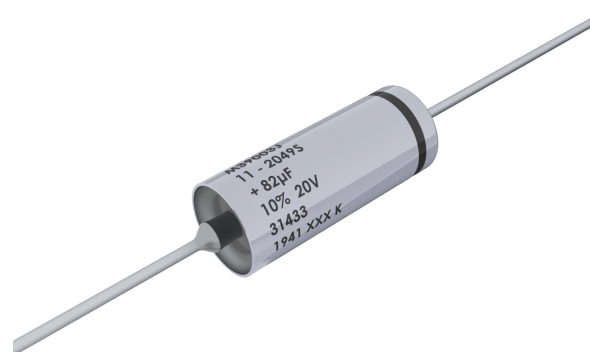

Ordering Information – T266

T	266	D	826	K	020	B	S	
Capacitor Class	Series	Case Size	Capacitance Code (pF)	Capacitance Tolerance	Rated Voltage (VDC)	Failure Rate	Termination Finish	C-Spec
T = Tantalum	266 (MIL-PRF-39003/11, CSS21)	C D	First two digits represent significant figures. Third digit specifies number of zeros to follow.	J = ±5% K = ±10% M = ±20%	006 = 6 010 = 10 015 = 15 020 = 20	Graded: B = 0.1%/k hours C = 0.01%/k hours	S = Standard (Solder-coated nickel)	Blank = Sleeved/Bulk 0100 = Unsleeved/Bulk 7200 = Tape & Reel All capacitors are sleeved unless specified.

Ordering Information – T266 (CSS21 Style)

MIL product

M39003	/11	2049	S
Capacitor Class	Slash	Dash Number	Sleeving option
Military Specification Number	Specification Sheet Number	Failure Rate Level	S = Sleeved U = Unsleeved use C-0100

Performance Characteristics

Item	Performance Characteristics
Operating Temperature	-55°C to 125°C
Rated Capacitance Range	27 – 330 µF at 1 kHz/25°C
Capacitance Tolerance	J Tolerance (±5%), K Tolerance (±10%), and M Tolerance (±20%)
Rated Voltage Range	6 – 20 V
DF (1 kHz at 25°C)	Refer to Part Number Electrical Specification Table
ESR (100 kHz at 25°C)	Refer to Part Number Electrical Specification Table
Leakage Current	Refer to Part Number Electrical Specification Table (rated voltage up to +125°C)
Failure Rate	Approved failure rate: B (0.1%/k hours) ,C (0.01%/k hours) - Graded

Dimensions – Inches (Millimeters)

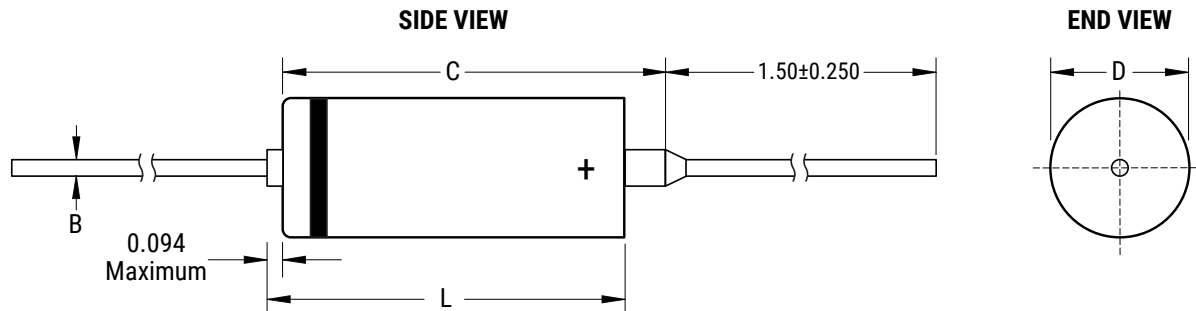

Case Size	Uninsulated		Insulated		B ±0.002 ±(0.05)	C Maximum
	D +0.016, -0.015 +(0.41), -(0.38)	L ±0.031 ±(0.79)	D +0.016, -0.015 +(0.41), -(0.38)	L ±0.031 ±(0.79)		
C	0.279 (7.09)	0.650 (16.51)	0.289 (7.34)	0.686 (17.42)	0.025 (0.64)	0.822 (20.88)
D	0.341 (8.66)	0.750 (19.05)	0.351 (8.92)	0.786 (19.96)	0.025 (0.64)	0.922 (23.42)

Table 1 – T266 Ratings & Part Number Reference

Rated Voltage	Rated Capacitance	Case Size Code	DC Leakage	DF % at 25°C	ESR	MIL-PRF-39003/11		
						Failure Rate Level (%/1,000 Hours)		KEMET Equivalent Military
						Graded		
(V) 85°C	1 kHz/25°C µF		µA at 25°C Maximum/5 Minutes	1 kHz Maximum	Ω at 25°C 100 kHz Max	B (0.1)	C (0.01)	Part Number
6	150	C	4.5	10	0.065	2001(1)	3001(1)	T266C157J006(2)S
6	150	C	4.5	10	0.065	2002(1)	3002(1)	T266C157K006(2)S
6	150	C	4.5	10	0.065	2003(1)	3003(1)	T266C157M006(2)S
6	180	C	5.5	10	0.06	2004(1)	3004(1)	T266C187J006(2)S
6	180	C	5.5	10	0.06	2005(1)	3005(1)	T266C187K006(2)S
6	270	D	6.5	10	0.05	2006(1)	3006(1)	T266D277J006(2)S
6	270	D	6.5	10	0.05	2007(1)	3007(1)	T266D277K006(2)S
6	330	D	7.5	12	0.045	2008(1)	3008(1)	T266D337J006(2)S
6	330	D	7.5	12	0.045	2009(1)	3009(1)	T266D337K006(2)S
6	330	D	7.5	12	0.045	2010(1)	3010(1)	T266D337M006(2)S
10	82	C	4	8	0.085	2011(1)	3011(1)	T266C826J010(2)S
10	82	C	4	8	0.085	2012(1)	3012(1)	T266C826K010(2)S
10	100	C	5	8	0.075	2013(1)	3013(1)	T266C107J010(2)S
10	100	C	5	8	0.075	2014(1)	3014(1)	T266C107K010(2)S
10	100	C	5	8	0.075	2015(1)	3015(1)	T266C107M010(2)S
10	120	C	6	8	0.07	2016(1)	3016(1)	T266C127J010(2)S
10	120	C	6	8	0.07	2017(1)	3017(1)	T266C127K010(2)S
10	180	D	9	8	0.06	2018(1)	3018(1)	T266D187J010(2)S
10	180	D	9	8	0.06	2019(1)	3019(1)	T266D187K010(2)S
10	220	D	10	10	0.055	2020(1)	3020(1)	T266D227J010(2)S
10	220	D	10	10	0.055	2021(1)	3021(1)	T266D227K010(2)S
10	220	D	10	10	0.055	2022(1)	3022(2)	T266D227M010(2)S
15	56	C	4	6	0.1	2023(1)	3023(1)	T266C566J015(2)S
15	56	C	4	6	0.1	2024(1)	3024(1)	T266C566K015(2)S
15	68	C	5	6	0.095	2025(1)	3025(1)	T266C686J015(2)S
15	68	C	5	6	0.095	2026(1)	3026(1)	T266C686K015(2)S
15	68	C	5	6	0.095	2027(1)	3027(1)	T266C686M015(2)S
15	120	D	9	8	0.07	2028(1)	3028(1)	T266D127J015(2)S
15	120	D	9	8	0.07	2029(1)	3029(1)	T266D127K015(2)S
15	150	D	10	8	0.065	2030(1)	3030(1)	T266D157J015(2)S
15	150	D	10	8	0.065	2031(1)	3031(1)	T266D157K015(2)S
15	150	D	10	8	0.065	2032(1)	3032(1)	T266D157M015(2)S
20	27	C	2.5	5	0.145	2033(1)	3033(1)	T266C276J020(2)S
20	27	C	2.5	5	0.145	2034(1)	3034(1)	T266C276K020(2)S
20	33	C	3.5	5	0.13	2035(1)	3035(1)	T266C336J020(2)S
20	33	C	3.5	5	0.13	2036(2)	3036(1)	T266C336K020(2)S
20	33	C	3.5	5	0.13	2037(1)	3037(1)	T266C336M020(2)S
20	39	C	4	5	0.12	2038(1)	3038(1)	T266C396J020(2)S
20	39	C	4	5	0.12	2039(1)	3039(1)	T266C396K020(2)S
20	47	C	4.5	6	0.11	2040(1)	3040(1)	T266C476J020(2)S
20	47	C	4.5	6	0.11	2041(1)	3041(1)	T266C476K020(2)S
20	47	C	4.5	6	0.11	2042(1)	3042(1)	T266C476M020(2)S
20	56	D	5.5	6	0.1	2043(1)	3043(1)	T266D566J020(2)S
20	56	D	5.5	6	0.1	2044(1)	3044(1)	T266D566K020(2)S
20	68	D	7	6	0.095	2045(1)	3045(1)	T266D686J020(2)S
20	68	D	7	6	0.095	2046(1)	3046(1)	T266D686K020(2)S
20	68	D	7	6	0.095	2047(1)	3047(1)	T266D686M020(2)S
20	82	D	8	6	0.085	2048(1)	3048(1)	T266D826J020(2)S
20	82	D	8	6	0.085	2049(1)	3049(1)	T266D826K020(2)S
20	100	D	10	8	0.075	2050(1)	3050(1)	T266D107J020(2)S
20	100	D	10	8	0.075	2051(1)	3051(1)	T266D107K020(2)S
20	100	D	10	8	0.075	2052(1)	3052(1)	T266D107M020(2)S
(V) 85°C	µF	Case Size Code	µA at 25°C Maximum/5 Minutes	120 Hz Maximum	Ω at 25°C 100 kHz Max	B (0.1)	C (0.01)	Part Number
Rated Voltage	Rated Capacitance	Case Size Code	DC Leakage	DF % at 25°C	ESR	MIL-PRF-39003 (CSS13 Style)		

(1) To complete MIL-PRF-39003 dash part number, insert S for sleeved or U for unsleeved. If "U" ordered also use C0100.

(2) To complete KEMET Part Number (T216, T256), insert Graded failure rate - B for .1%/k hours, C for .01%/k hours. Designates reliability level.

Ripple Current/Ripple Voltage

Permissible AC ripple voltage is related to the ESR of the capacitor and the power dissipation capabilities of a particular case size.

Thermal capacities for the various case sizes have been determined empirically and are listed below.

Temperature Compensation Multipliers for Maximum Power Dissipation		
T ≤ 25°C	T ≤ 85°C	T ≤ 125°C
1.00	0.90	0.40

T = Environmental Temperature

Permissible AC ripple current can be determined by the following:

$$I(max) = Z \sqrt{P_{max}/R}$$

P max = maximum watts

R = ESR at specified frequency (ohms)

I = rms ripple current (amperes)

Z = capacitor impedance in ohms at the specified frequency

Case Size	Maximum Power Dissipation (Pmax) Watts at 25°C	T2XX
A	0.09	0.070
B	0.100	0.090
C	0.125	-
D	0.180	-

Maximum Power Dissipation: 25°C Ambient

Optimum Solder Wave Profile

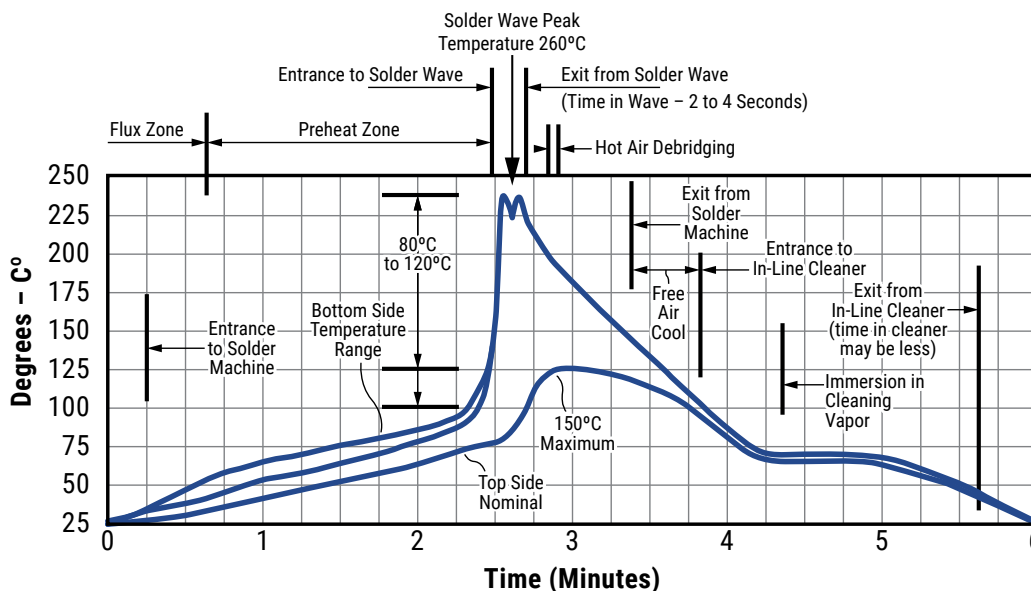

Construction

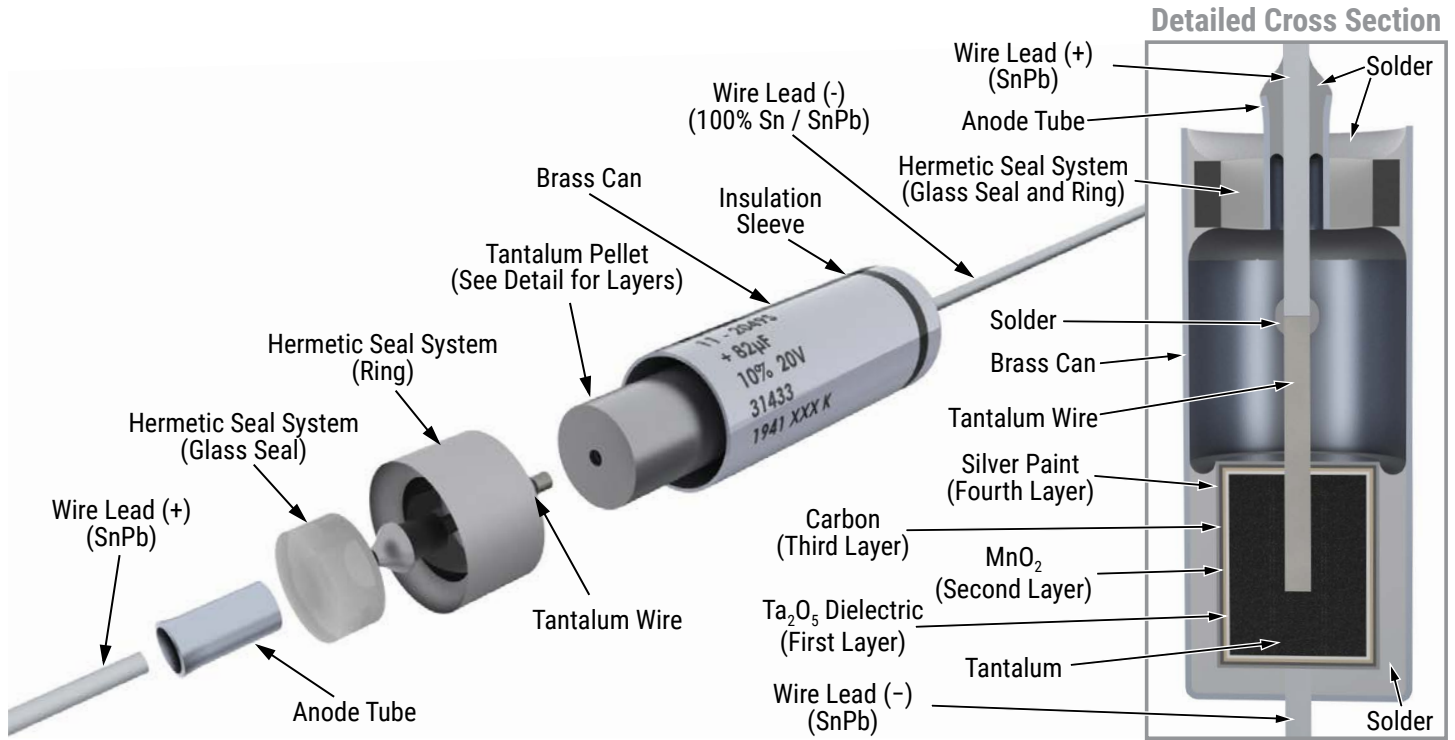

Capacitor Marking

C & D Case

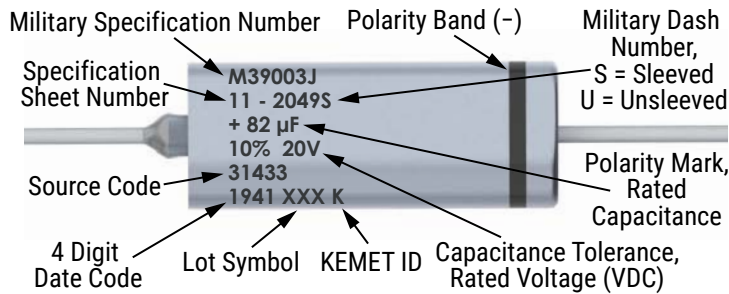

Date Code

Date Code	
First Two Digits	Indicates the last two digits of year 18 = 2018 19 = 2019 20 = 2020
Third & Fourth Digits	Indicates the week of the year 01 = 1st week 52 = 52nd week

Storage

Tantalum hermetically sealed capacitors should be stored in normal working environments. While the capacitors themselves are quite robust in other environments, solderability will be degraded by exposure to high temperatures, high humidity, corrosive atmospheres, and long term storage. In addition, packaging materials will be degraded by high temperature – reels may soften or warp and tape peel force may increase. KEMET recommends that maximum storage temperature not exceed 40°C and maximum storage humidity not exceed 60% relative humidity. Temperature fluctuations should be minimized to avoid condensation on the parts and atmospheres should be free of chlorine and sulphur bearing compounds. For optimized solderability capacitors stock should be used promptly, preferably within three years of receipt.

Tape & Reel Packaging Information

KEMET offers standard reeling of Solid Tantalum Capacitors for automatic insertion or lead forming machines per EIA Specification RS-296.

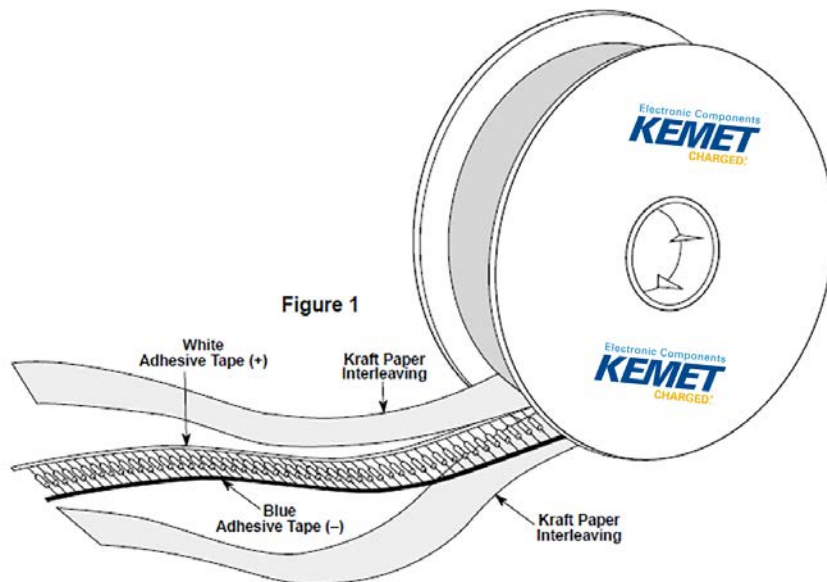

Table 2 – Packaging Quantity

Case Size	Standard Bulk Quantity	Standard Reel Quantity	Reel C-Spec	Ammo Pack Quantity	Ammo Pack C-Spec
A	150/Box	3,500	C-7200	1,500	C-7293
B	75/Box	2,500	C-7200	1,000	Class I
C	20/Tray	500	C-7200	250	C-7442
D	20/Tray	400	C-7200	250	Class II C-7443 Class III

Figure 2

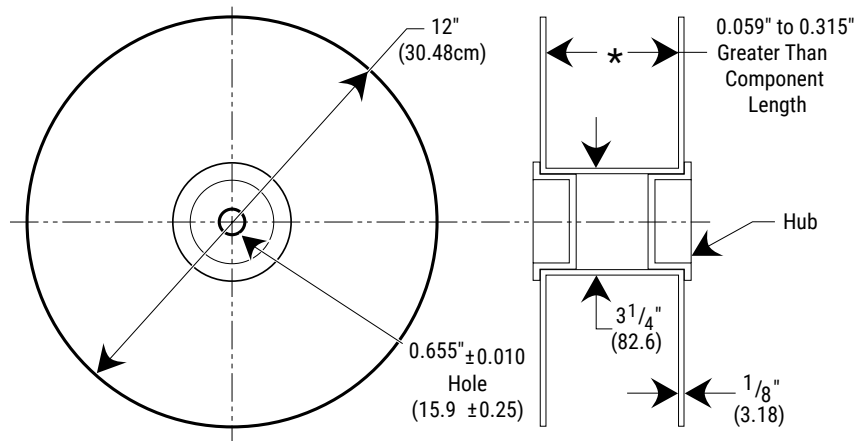

Figure 3

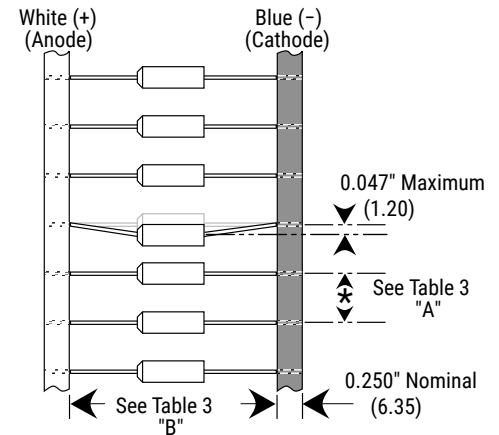

Table 3 – Tape Dimensions

Dimensions in Inches (& Millimeters)

BODY DIAMETER	A PITCH ±0.020 (0.5)	B INSIDE TAPE SPACING
≤ 0.197 (5.0)	0.200 (5.0)	2.063 (52.4) +0.079, -0.039 (+2.0, -1.0)
0.198 (5.0) to 0.394 (10.0)	0.400 or (10.0)	2.874 (73) +/0.059

Capacitors are reeled so that positive leads are oriented as shown in Figure 3. Kraft paper (50 lbs. test minimum) is inserted between the layers of capacitors wound on reels for component pitch ≤ 0.200" sizes and corrugated paper (70 lbs. test minimum), single faced is inserted for component pitch ≥ 0.400" sizes. Capacitor lead length may extend only a maximum of 0.031" (0.8 mm) beyond the tape's edges. Capacitors are centered in a row between the two tapes and will deviate only ±0.031" (0.79 mm) from the row center.

Figures 1 and 2 show the KEMET standard chipboard tape reel.

A minimum of 36" (91.5 cm) leader tape is provided at each end of the reeled capacitors.

Universal splicing clips are used to connect the tape.

KEMET Electronics Corporation Sales Offices

For a complete list of our global sales offices, please visit www.kemet.com/sales.

Disclaimer

All product specifications, statements, information and data (collectively, the "Information") in this datasheet are subject to change. The customer is responsible for checking and verifying the extent to which the Information contained in this publication is applicable to an order at the time the order is placed. All Information given herein is believed to be accurate and reliable, but it is presented without guarantee, warranty, or responsibility of any kind, expressed or implied.

Statements of suitability for certain applications are based on KEMET Electronics Corporation's ("KEMET") knowledge of typical operating conditions for such applications, but are not intended to constitute – and KEMET specifically disclaims – any warranty concerning suitability for a specific customer application or use. The Information is intended for use only by customers who have the requisite experience and capability to determine the correct products for their application. Any technical advice inferred from this Information or otherwise provided by KEMET with reference to the use of KEMET's products is given gratis, and KEMET assumes no obligation or liability for the advice given or results obtained.

Although KEMET designs and manufactures its products to the most stringent quality and safety standards, given the current state of the art, isolated component failures may still occur. Accordingly, customer applications which require a high degree of reliability or safety should employ suitable designs or other safeguards (such as installation of protective circuitry or redundancies) in order to ensure that the failure of an electrical component does not result in a risk of personal injury or property damage.

Although all product-related warnings, cautions and notes must be observed, the customer should not assume that all safety measures are indicated or that other measures may not be required.

KEMET is a registered trademark of KEMET Electronics Corporation.