

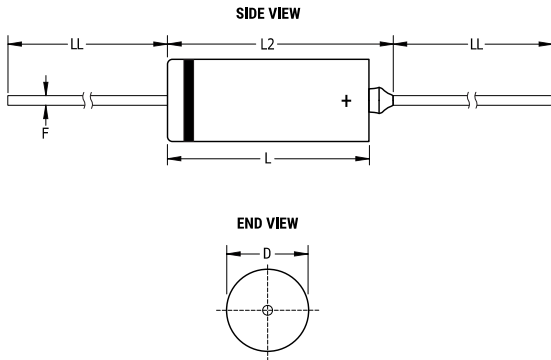

KEMET Part Number: M39003/11-2019U
(T266D187K010BS0100, CSS21C187KBU)

T266 CSS21, Tantalum, MnO2 Tantalum, Space, 180 uF, 10%, 10 VDC, 100 mOhms



Dimensions	
D	8.66mm +0.41/-0.38mm
L	19.05mm +/-0.79mm
L2	23.42mm MAX
LL	38.1mm +/-6.35mm
F	0.64mm +/-0.05mm

Packaging Specifications	
Packaging:	Tray
Packaging Quantity:	20

General Information	
Series:	T266 CSS21
Dielectric:	MnO2 Tantalum
Style:	Axial Hermetic
Description:	Axial, Solid Tantalum, Hermetically Sealed, Military, CSS21 Style
RoHS:	No
Prop 65:	 WARNING: Cancer and reproductive harm - www.p65warnings.ca.gov
REACH:	SVHC (Pb – CAS 7439-92-1)
Termination:	Lead (SnPb)
Lead:	Wire Leads
Qualifications:	CSS21
AEC-Q200:	No
Construction:	Hermetic

Specifications	
Capacitance:	180 uF
Capacitance Tolerance:	10%
Voltage DC:	10 VDC (85C)
Temperature Range:	-55/+125°C
Rated Temperature:	85°C
Dissipation Factor:	8% 1kHz 25C
Failure Rate:	B (0.1%/1000 Hrs)
Resistance:	0.1 Ohms (100kHz)
Leakage Current:	9 uA