

# ACE1V2012

## Automotive grade common-mode chip inductor



### Product features

- AEC-Q200 qualified
- 0805 (2012 metric) package
- Impedance range from 90 ohms to 2200 ohms
- Moisture sensitivity level (MSL): 1

### Applications

- Controller area network (CAN)
- Ethernet architectures
- Automotive signal line filter
- Advanced driver assistance systems (ADAS)
- Infotainment, safety cameras, sensors, xEV, Powertrain
- Engine control unit (ECU)
- Electric power steering system (EPS)
- Battery management systems (BMS)

### Environmental compliance and general specifications

- Operating temperature range: -40 °C to +105 °C (ambient plus self-temperature rise)
- Solder reflow temperature: J-STD-020 (latest revision) compliant



**Product specifications**

Part number	Common-mode impedance Z (Ω) at 100 MHz	DCR (Ω) @ +25 °C maximum	I <sub>dc</sub> (mA) maximum	Rated voltage (Vdc) typical	Insulation resistance (MΩ) minimum	Withstanding voltage (Vdc) typical
ACE1V2012-900-R	90 ±25%	0.3	400	50	10	125
ACE1V2012-121-R	120 ±25%	0.3	370	50	10	125
ACE1V2012-201-R	200 ±25%	0.35	330	50	10	125
ACE1V2012-361-R	360 ±25%	0.4	280	50	10	125
ACE1V2012-681-R	680 ±25%	0.8	220	50	10	125
ACE1V2012-102-R	1000 ±25%	1.5	190	50	10	125
ACE1V2012-222-R	2200 ±25%	2.0	150	50	10	125

1. Part Number Definition: ACE1V2012-xxn-R  
 ACE1V2012 = Product code and size  
 xx= inductance value in ohms,  
 n= multiplication factor: 10<sup>n</sup> (i.e. 900 = 90 \* 10<sup>0</sup> = 90 ohms)  
 -R suffix = RoHS compliant

**Mechanical parameters, schematic, pad layout (mm)**

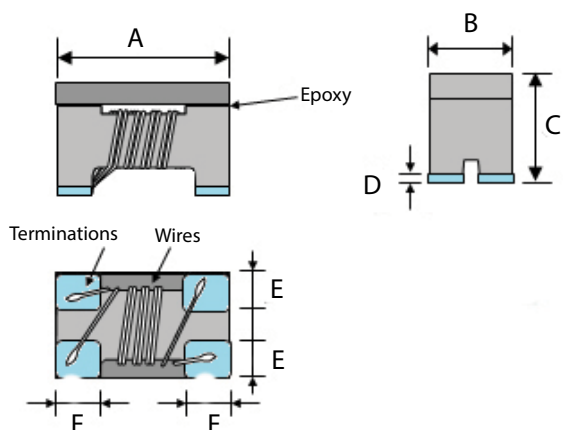

**Recommended pad layout**

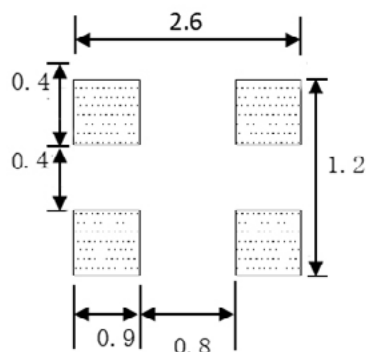

**Equivalent circuit**

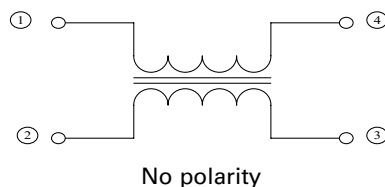

Part Number	A	B	C	D	E	F
ACE1V2012-xxn-R	2.0 ±0.2	1.2 ±0.2	1.2 ±0.2	0.2 ±0.1	0.40 typ	0.45 typ

All soldering surfaces to be coplanar within 0.1 millimeters  
 Tolerances are ±0.1 millimeters unless stated otherwise  
 Pad layout dimensions are reference only  
 Traces or vias underneath the inductor is not recommended

**Packaging information (mm)**

Supplied in tape and reel packaging, 2000 parts per 7" diameter reel

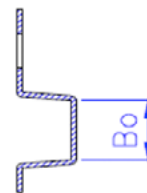
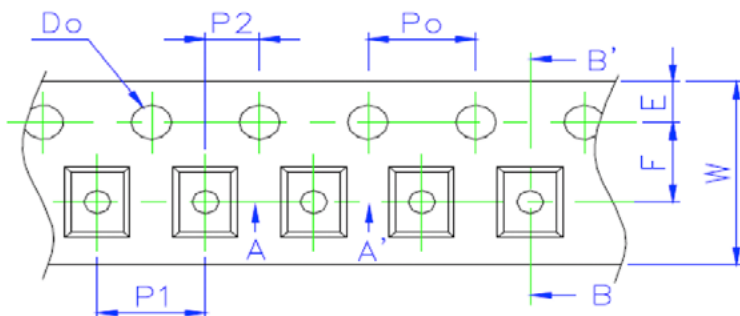

SEC: B-B'

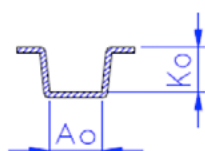

SEC: A-A'

Ao	1.50±0.10
Bo	2.35±0.10
Ko	1.45±0.10
W	8.00±0.20
E	1.75±0.10
F	3.50±0.05
Po	4.0±0.05
P1	4.0±0.10
Do	1.0±0.1

Performance curves

ACE1V2012-900-R

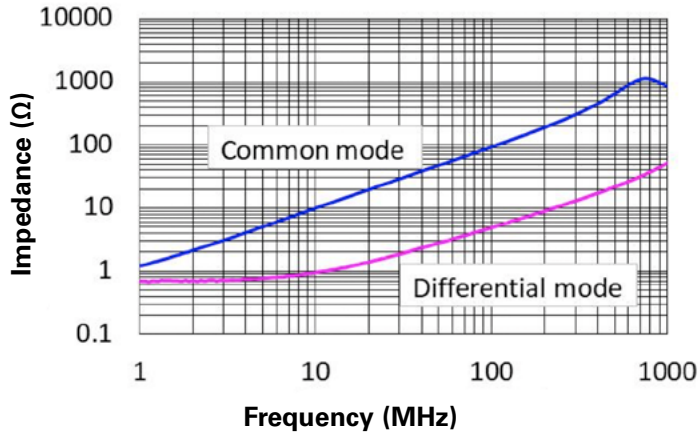

ACE1V2012-121-R

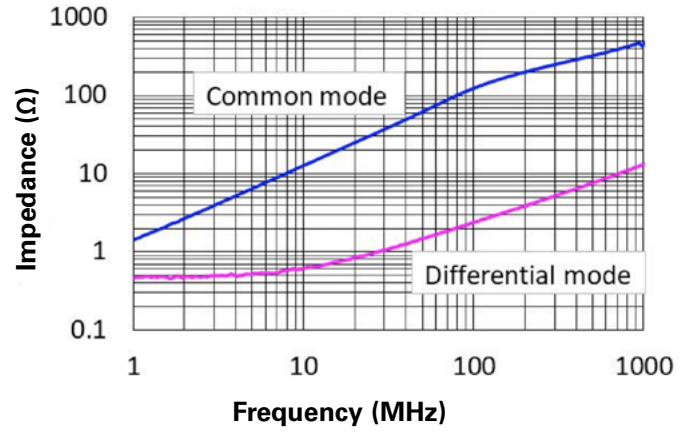

ACE1V2012-201-R

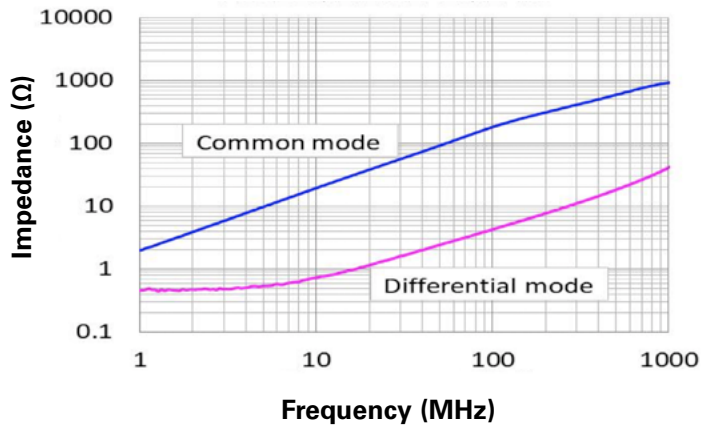

ACE1V2012-361-R

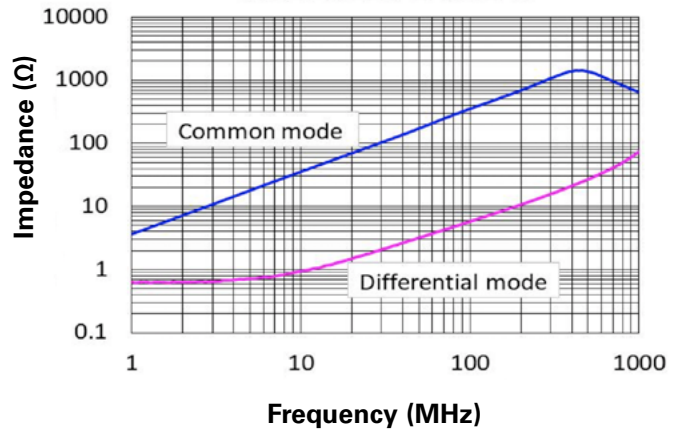

ACE1V2012-681-R

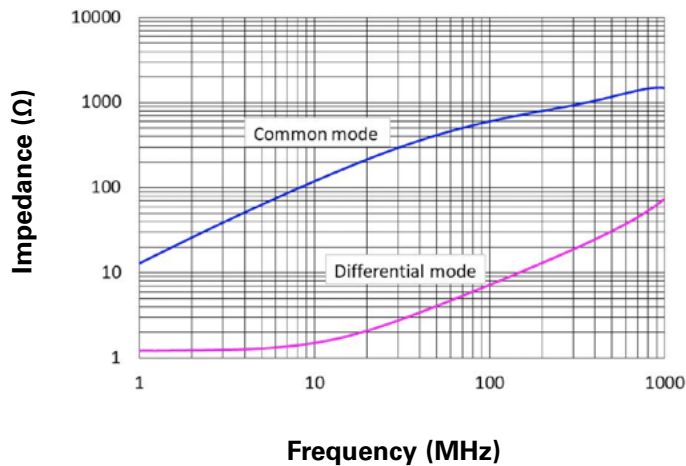

ACE1V2012-102-R

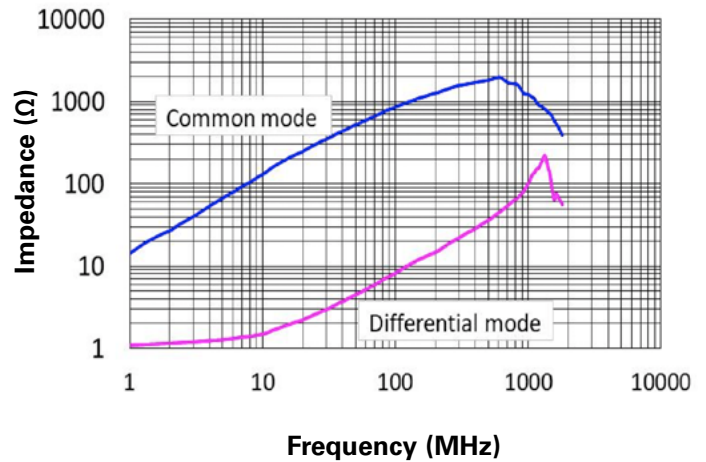

Performance curves

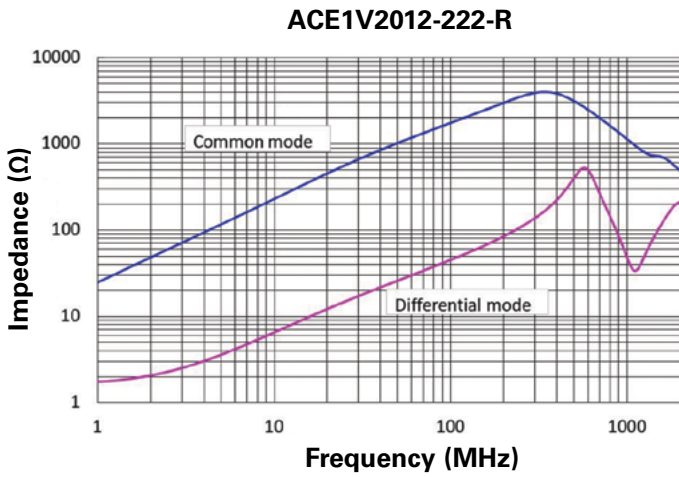

Common mode measurement method:

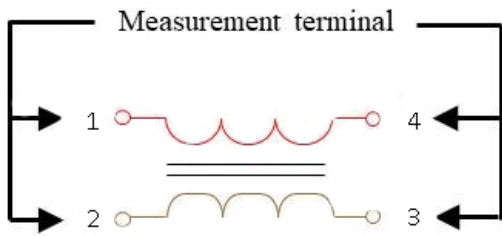

Differential mode measurement method:

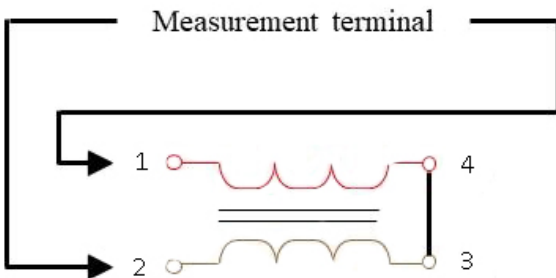

**Solder reflow profile**

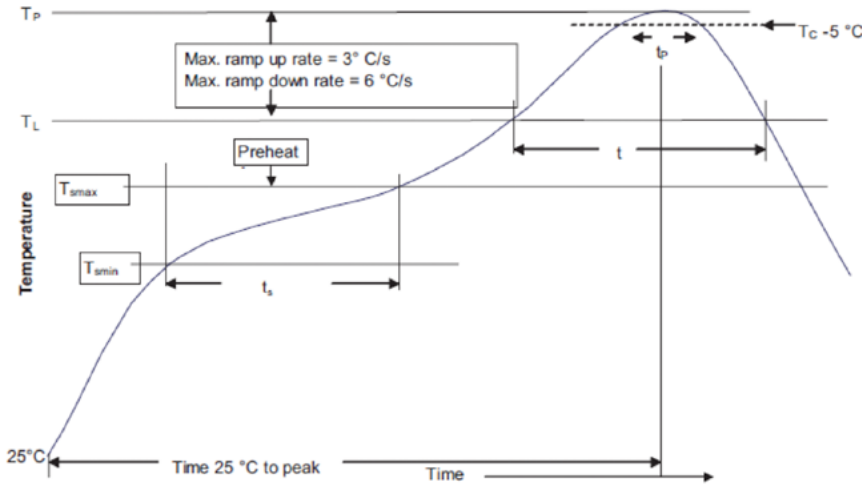

**Table 1 - Standard SnPb solder ( $T_C$ )**

Package thickness	Volume mm <sup>3</sup> <350	Volume mm <sup>3</sup> ≥350
<2.5 mm)	235 °C	220 °C
≥2.5 mm	220 °C	220 °C

**Table 2 - Lead (Pb) free solder ( $T_C$ )**

Package thickness	Volume mm <sup>3</sup> <350	Volume mm <sup>3</sup> 350 - 2000	Volume mm <sup>3</sup> >2000
<1.6 mm	260 °C	260 °C	260 °C
1.6 – 2.5 mm	260 °C	250 °C	245 °C
>2.5 mm	250 °C	245 °C	245 °C

**Reference J-STD-020**

Profile feature	Standard SnPb solder	Lead (Pb) free solder
Preheat and soak		
• Temperature min. ( $T_{smin}$ )	100 °C	150 °C
• Temperature max. ( $T_{smax}$ )	150 °C	200 °C
• Time ( $T_{smin}$ to $T_{smax}$ ) ( $t_s$ )	60-120 seconds	60-120 seconds
Ramp up rate $T_L$ to $T_P$	3 °C/ second max.	3 °C/ second max.
Liquidous temperature ( $T_L$ )	183 °C	217 °C
Time ( $t_L$ ) maintained above $T_L$	60-150 seconds	60-150 seconds
Peak package body temperature ( $T_P$ )*	Table 1	Table 2
Time ( $t_p$ )* within 5 °C of the specified classification temperature ( $T_C$ )	20 seconds*	30 seconds*
Ramp-down rate ( $T_P$ to $T_L$ )	6 °C/ second max.	6 °C/ second max.
Time 25 °C to peak temperature	6 minutes max.	8 minutes max.

\* Tolerance for peak profile temperature ( $T_P$ ) is defined as a supplier minimum and a user maximum.

Life Support Policy: Eaton does not authorize the use of any of its products for use in life support devices or systems without the express written approval of an officer of the Company. Life support systems are devices which support or sustain life, and whose failure to perform, when properly used in accordance with instructions for use provided in the labeling, can be reasonably expected to result in significant injury to the user.

Eaton reserves the right, without notice, to change design or construction of any products and to discontinue or limit distribution of any products. Eaton also reserves the right to change or update, without notice, any technical information contained in this bulletin.

**Eaton**  
**Electronics Division**  
 1000 Eaton Boulevard  
 Cleveland, OH 44122  
 United States  
 Eaton.com/electronics

© 2019 Eaton  
 All Rights Reserved  
 Printed in USA  
 Publication No. 10984 BU-MC19112  
 November 2019

Eaton is a registered trademark.  
 All other trademarks are property of their respective owners.

Follow us on social media to get the latest product and support information.

