



INSTRUMET 19" CASES

[Home Page](#)
[E-Mail Us](#)
[Catalogue PDF](#)
[Get a Catalogue](#)
[Get a Drawing](#)
[Get a Price](#)
[Get a Quote](#)
[Customising](#)
[IP Ratings](#)
[Colour Chart](#)
[Ordering Info](#)
 **01489 583858**
 **01489 583836**

FEATURES:

- Modern aluminium 19" instrument cases
- Light weight yet robust construction
- Conforms to DIN 41494 & IEC 297-1
- Designed to accept standard 3U x 19" subracks, chassis and front panels
- Attractive design with die-cast front and rear bezels and fabricated case body
- Two versions, in three sizes
- Standard models with ABS side handles
- Portable models with tilt/swivel aluminium carry handle bar
- Supplied fully assembled and ready to use
- Internal subrack/chassis support rails
- Removable rear panel included
- Ventilation holes in base and rear panels
- Three M4 earth studs provided inside
- Moulded ABS non-slip tilt feet included
- Anodised 10.5"/19" front panels available as accessories

MATERIAL:

- Aluminium

PROTECTION CLASS:

- < IP 40 (Not rated)

STANDARD COLOUR:

- Front bezel - window grey, RAL 7040
- Case body - light grey, RAL 7035 (powder polyester paint)

SUPPLY:

1. Front/rear bezel (x2)
2. Top cover
3. Base panel
4. Rear panel
5. Chassis support
6. ABS Side handle
7. Aluminium carry handle
8. ABS tilt feet
9. M4 x 10 mm (x8)
M4 x 12 mm (x4)
10. M3 x 8 mm (x12)

ACCESSORIES:

- 10.5"/19" Front Panel
- 19" Subrack/ Front Panel Mounting Kit

APPLICATIONS:

- 19" subrack or chassis based electronics such as test and measurement equipment, networking and communications devices, industrial computers, sound and studio systems, laboratory instruments and industrial control systems.

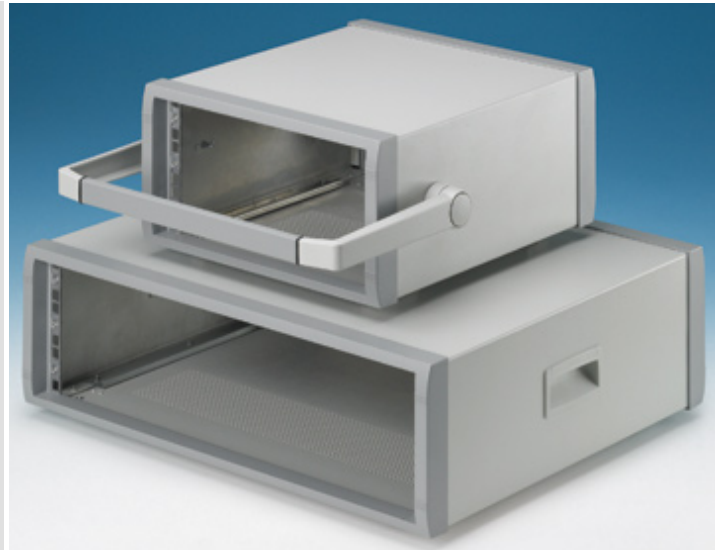
 [Printable Page](#)

Modern 19" Instrument Cases



Subrack Mounting



Carry Handle Bar





ABS Tilt Feet

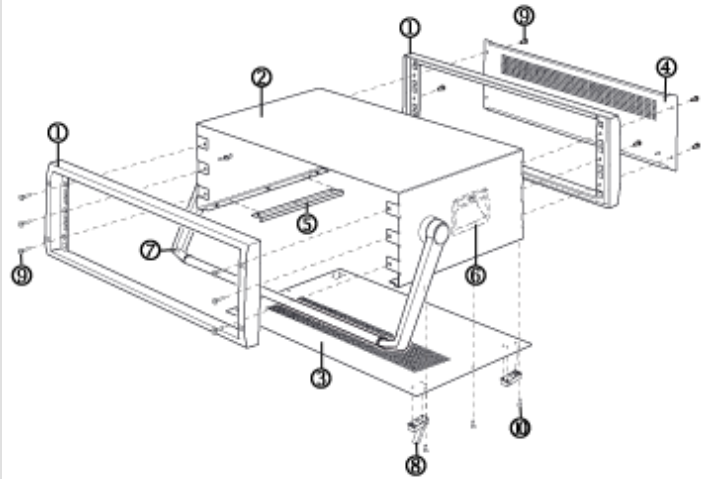

Accessory Front Panels



INSTRUMET 10.5" CASES

							
Part No. Standard Model	Part No. Portable Model	Type	H	W	D	Drawings	
M6010305		3U x 10.5"	157	303	350	PDF	DWG
	M6010315	3U x 10.5"	157	303	350	PDF	DWG

INSTRUMET 19" CASES

							
Part No. Standard Model	Part No. Portable Model	Type	H	W	D	Drawings	
M6019305		3U x 19"	157	516	350	PDF	DWG
	M6019315	3U x 19"	157	516	350	PDF	DWG
M6019325		3U x 19"	157	516	450	PDF	DWG
	M6019335	3U x 19"	157	516	450	PDF	DWG

ACCESSORIES



For case..	Part No. Aluminium Front Panel		Part No. Subrack/Front Panel Mtg Kit*		Drawings	
3U x 10.5"	M6010001	£			PDF	DWG
3U x 19"	M6019001	£			PDF	DWG
All			M6000035	£		

Notes:
 * Front Panel Kit - Anodised front panel
 * 19" Subrack/Front Panel Mounting Kit - 4 M6 caged nuts, 4 M6 Screws & 4 ABS plastic washers (RAL 7035)

 [Printable Page](#)



[Customising](#)

Tel: (01489) 583858 Last Updated: 27-Feb-2008 ©OKW Enclosures Ltd. UK. All rights reserved.

FIRST ANGLE PROJECTION

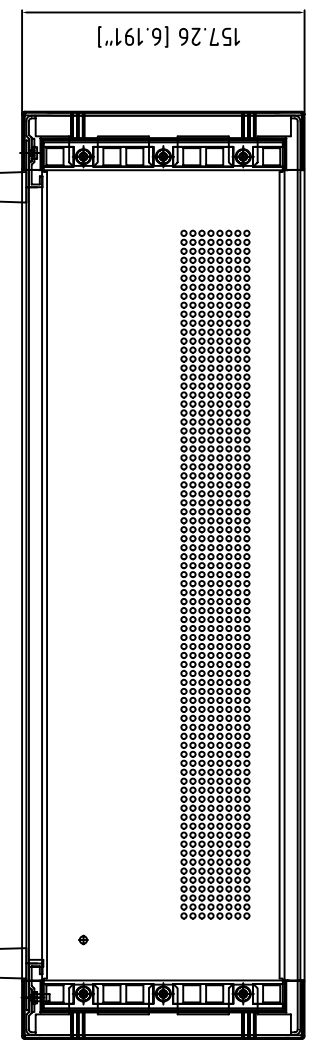
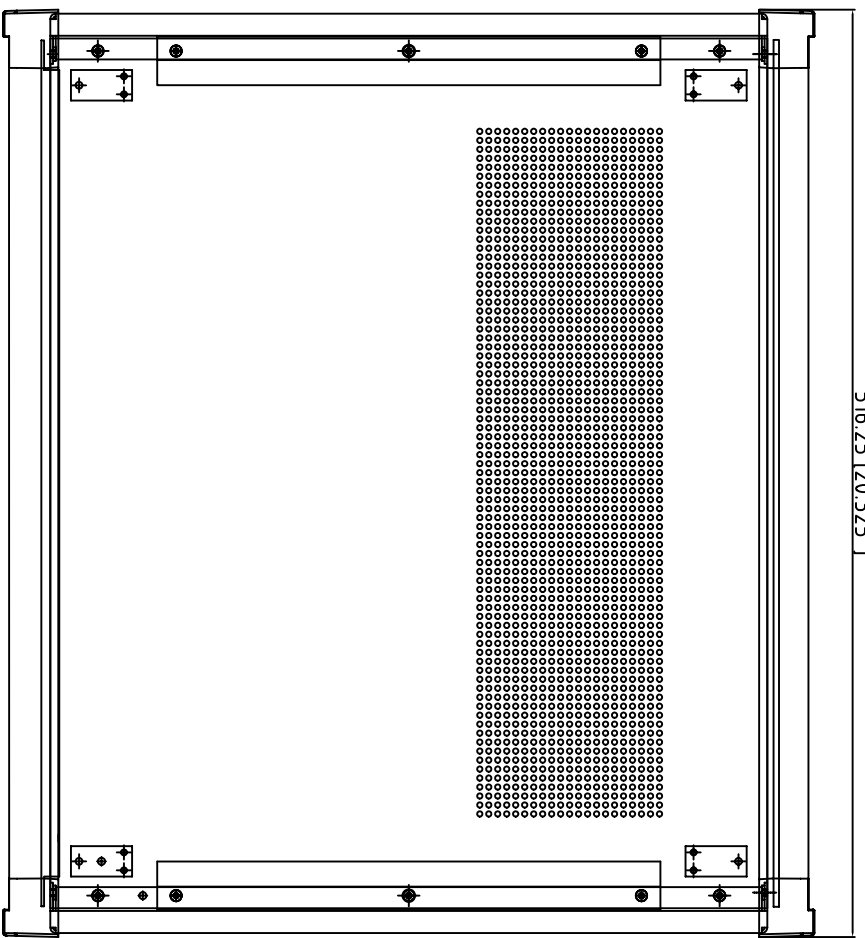
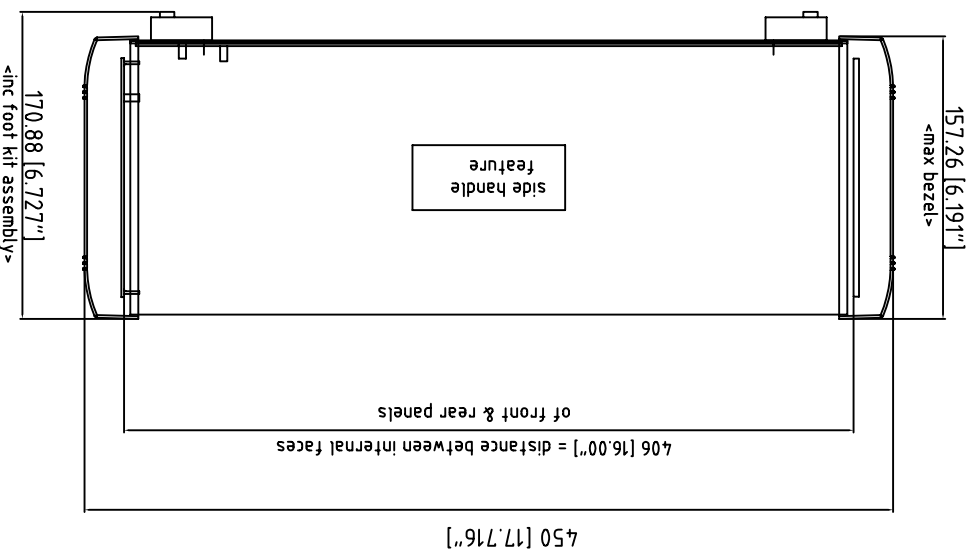

Notes.

- 1) The geometry is in colour coded blocks as follows:
 - case body - white
 - base panel - magenta
 - rear panel - yellow
 - internal chassis supports - navy blue
 - bezels - pale blue
 - feet - red
 - front panel (optional accessory) - green
- 2) The rear panel & base panel are vented with 3mm dia holes as follows:
 - rear - 648 off
 - base - 1701 off
- 3) The case body, base & rear panels are made from 1.5mm thick aluminium & painted fine texture powder RAL 7035. All parts have M4, x 10 studs fitted for earthing.
- 4) The bezels are painted fine texture powder RAL 7040.
- 5) The side grip handles are moulded ABS RAL 7035.
- 6) The front panel (optional accessory) is made from 3mm aluminium & has an etch & clear anodise finish.

Modifications

1

Iss

Tolerances unless otherwise stated:

General tolerances ±0.20

Resultant tolerances between hole centers ±0.15

Tolerances on hole diameters ±0.05

Angles ± 0.5°

Surface finish 32/

Required Finish:

See notes

ALL DIMENSIONS IN MILLIMETRES

DO NOT SCALE

Scale: 1:1

Drawn By: Ian Cox

Checked By:

Drawing Number

--

Date drawn: Nov '07

Material Spec.

www.metcase.com



METCASE ENCLOSURES
15 Brunel Way
Segensworth East, Fareham,
Hampshire, PO15 5TX, UK.

Part Name
Instrument 3U x 19" x 450mm - Side Handles

Part Number
M6019325

Sheet 1 of 1

OKW ENCLOSURES LTD (DATE AS SHOWN). THIS DRAWING CONTAINS PROPRIETARY INFORMATION OF OKW ENCLOSURES LTD AND IS TENDERED SUBJECT TO THE FOLLOWING CONDITIONS: THE INFORMATION BE RETAINED IN CONFIDENCE, NOT BE REPRODUCED OR COPIED, AND NOT BE USED OR INCORPORATED IN ANY PRODUCT, UNLESS PERMISSION IS OBTAINED IN WRITING FROM OKW ENCLOSURES LTD.

A2