

NFL18ST706H1A3#

“#” indicates a package specification code.



< List of part numbers with package codes >

NFL18ST706H1A3D NFL18ST706H1A3B

Appearance & Shape

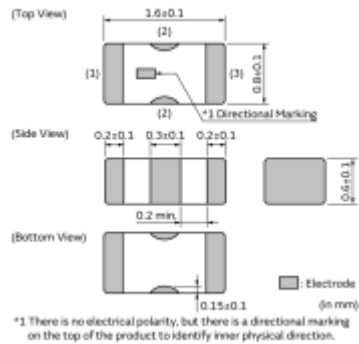

Packaging Information

Packaging	Specifications	Minimum Order Quantity
D	180mm Paper Tape	4000
B	Bulk(Bag)	1000

Applications

Other Usage	For general
-------------	-------------

Attention
1.This datasheet is downloaded from the website of Murata Manufacturing Co., Ltd. Therefore, it's specifications are subject to change or our products in it may be discontinued without advance notice. Please check with our sales representatives or product engineers before ordering.
2.This datasheet has only typical specifications because there is no space for detailed specifications.
Therefore, please review our product specifications or consult the approval sheet for product specifications before ordering.

NFL18ST706H1A3#

“#” indicates a package specification code.

Features

Features (NFL18ST_H/NFL18ZT series)

1. This product is compact size EMI suppression filter of 1.6x0.8x0.6mm. It has steep and deep insertion loss characteristics with T-type circuit.
2. This product has large insertion loss in wide frequency range, results to good noise suppression effect.
3. Sharp insertion loss curve enables both high noise suppression effect and low damage to signal waveform.
4. There are 6 line up of cutoff frequency between 50MHz to 500MHz.

Application

EMI suppression of clock lines, video lines.

Attention

- 1.This datasheet is downloaded from the website of Murata Manufacturing Co., Ltd. Therefore, it's specifications are subject to change or our products in it may be discontinued without advance notice. Please check with our sales representatives or product engineers before ordering.
- 2.This datasheet has only typical specifications because there is no space for detailed specifications.
Therefore, please review our product specifications or consult the approval sheet for product specifications before ordering.

NFL18ST706H1A3#

“#” indicates a package specification code.

Specifications

Shape	SMD
Size Code (in mm)	1608
Size Code (in inch)	0603
Length	1.6mm
Length Tolerance	±0.1mm
Width	0.8mm
Width Tolerance	±0.1mm
Thickness	0.6mm
Thickness Tolerance	±0.1mm
Rated Current	75mA
Operating Temperature Range	-55°C to 125°C
Mass(typ.)	0.004g
Number of Circuit	1
Rated Voltage	10Vdc
Withstanding Voltage	30Vdc
Insulation Resistance(min.)	1000MΩ
Nominal Cut-off Frequency	70MHz
Capacitance	70pF
Inductance	230nH
Insertion Loss	6dB max.(0 to 70MHz),30dB min.(300 to 1000MHz)

Attention

1.This datasheet is downloaded from the website of Murata Manufacturing Co., Ltd. Therefore, it's specifications are subject to change or our products in it may be discontinued without advance notice. Please check with our sales representatives or product engineers before ordering.

2.This datasheet has only typical specifications because there is no space for detailed specifications.

Therefore, please review our product specifications or consult the approval sheet for product specifications before ordering.

NFL18ST706H1A3#

"#" indicates a package specification code.

Product Data

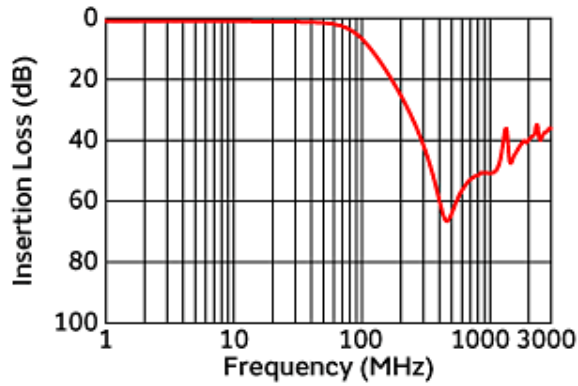

Insertion Loss Characteristics

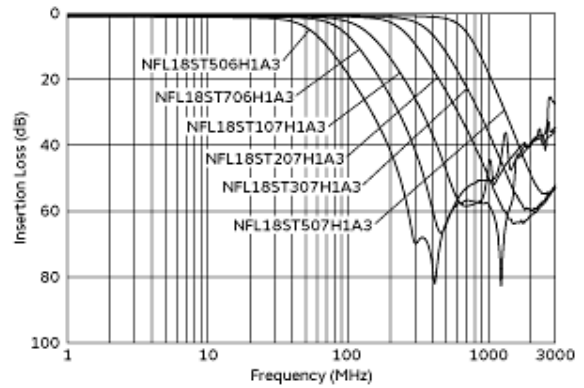

Insertion Loss Characteristics (Main Items)

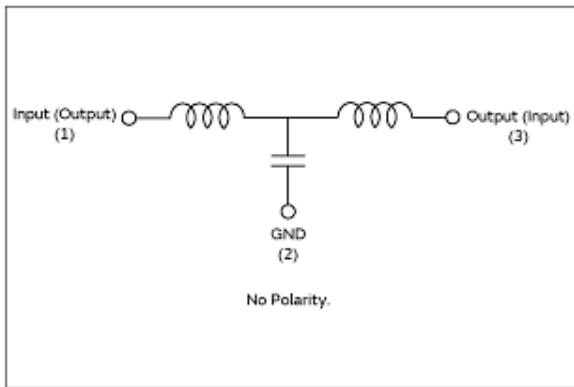

Equivalent Circuit

Attention

1.This datasheet is downloaded from the website of Murata Manufacturing Co., Ltd. Therefore, it's specifications are subject to change or our products in it may be discontinued without advance notice. Please check with our sales representatives or product engineers before ordering.
2.This datasheet has only typical specifications because there is no space for detailed specifications.
Therefore, please review our product specifications or consult the approval sheet for product specifications before ordering.