

# Features

# Regulated Converter

- 2"x3" optional 2"x4", low profile design
- 60W power from -40°C up to +55°C ambient
- Operating temperature up to +85°C with derating
- 4 kVAC/1min reinforced isolation
- 2MOPP medical certified, B and BF compliant
- 4000m/5000m (medical/ITE) operating altitude
- Class B EMC filter built-in

# RECOM AC/DC Converter

## RACM60-K/OF

60 Watt  
Open Frame  
2"x3" & 2"x4"  
Single Output

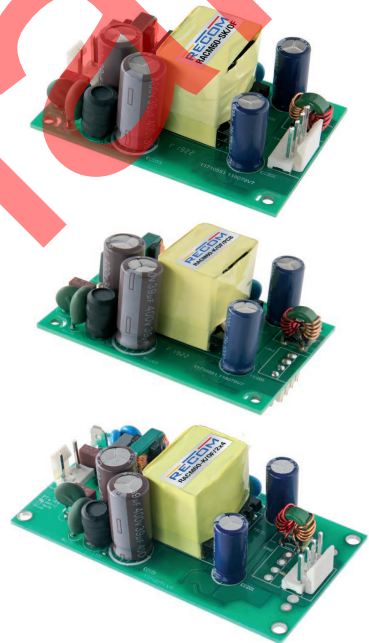

### Description

The multi-purpose, industrial + household + medical grade AC/DC converter series RACM60-K/OF delivers 60 Watts of output power from -40°C to +55°C with natural air convection only, and up to +85°C with derating or forced cooling. With a clear focus on extended thermal performance for systems where space is limited, these 2" x 3" compact modules are designed to gain highest overall efficiency levels over the full output load range from universal AC inputs. The RACM60-K/OF has ANSI/AAMI/IEC 60601-1 medical safety and EN 60601-1-2 medical EMC certifications and offers 4kVAC/1 min isolation, 2MOPP and designed to meet B and BF requirements. It is additionally certified to IEC/EN62368-1(CB Report) and IEC61558-1/-2-16 for industrial applications and IEC/EN60335-1 for household appliances. The robust built-in Class B EMC filter has sufficient margin to allow both Installation Class II or Class I PELV with grounded output. A range of mechanical fixing options makes the RACM60 suitable for many different mounting conditions: the standard chassis mount part mates with Molex connectors and the /PCB option permits direct installation in printed circuit boards. Additionally, a 2" x 4" footprint for backwards-compatibility with legacy designs is available on request.

### Selection Guide

Part Number	Input Voltage Range [VAC]	Output Voltage [VDC]	Output Current [mA]	Output Power [W]	Efficiency typ. (%)
RACM60-05SK/OF (2,3)	80-264	5	8000	40	89
RACM60-12SK/OF (2,3)	80-264	12	5000	60	90
RACM60-15SK/OF (2,3)	80-264	15	4000	60	90
RACM60-24SK/OF (2,3)	80-264	24	2500	60	90
RACM60-36SK/OF (2,3)	80-264	36	1667	60	90
RACM60-48SK/OF (2,3)	80-264	48	1250	60	90

#### Notes:

Note1: Efficiency is tested at nominal input and full load at +25°C ambient

### Model Numbering

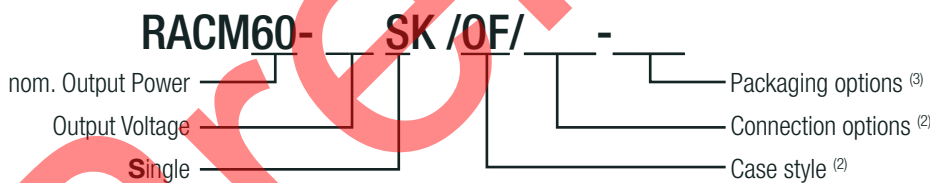

#### Notes:

Note2: "/OF" = standard 2"x3" open frame version with standard header connectors  
 "/OF/PCB-T" = 2"x3" open frame with PCB mounting pins in single tray packaging (05, 12, 24Vout versions available)  
 "/OF/2x4" = 2"x4" open frame version with standard header connectors (12 and 24Vout versions available)  
 For other case/connection/footprint options, please contact RECOM technical support

Note3: without suffix, standard single pack (1pcs/cardboard box)  
 add suffix "-CTN" for project packaging (4 layers of tray within a carton, for "/OF" only + MOQ= 1152pcs)  
 for detail information, refer to "PACKAGING INFORMATION"

#### Ordering Examples:

RACM60-05SK/OF	5Vout	2" x 3"	open frame	standard header connector	1pcs/cardboard box
RACM60-24SK/OF/PCB-T	24Vout	2" x 3"	open frame	PCB mounting pins	12pcs/tray packaging
RACM60-12SK/OF/2x4	12Vout	2" x 4"	open frame	standard header connector	1pcs/cardboard box
RACM60-12SK/OF-CTN	12Vout	2" x 4"	open frame	standard header connector	48pcs/carton (MOQ= 1152pcs)

IEC/EN62368-1 (pending)  
 ANSI/AAMI ES60601-1 Ed. 3.1 (pending)  
 CSA/CAN-C22.2 No. 60601-1:14 (pending)  
 IEC/EN60335-1 (pending)  
 IEC/EN61558-1 (pending)  
 IEC/EN61558-2-16 (pending)  
 EN60601-1-2 compliant  
 EN55032 compliant  
 EN55035 compliant  
 CB Report (pending)

**Specifications** (measured @ Ta= 25°C, nom. Vin, full load and after warm-up unless otherwise stated)

### BASIC CHARACTERISTICS

Parameter	Condition		Min.	Typ.	Max.
Internal Input Filter			Pi Type		
Nom. Input Voltage			100VAC		240VAC
Input Voltage Range <sup>(3,4)</sup>			80VAC 120VDC		264VAC 370VDC
Input Current	115VAC 230VAC				1400mA 600mA
Inrush Current	cold start	115VAC 230VAC			30A 60A
ErP Standby Mode Conformity (Output Load Capability)	115/230VAC	0.5W 1.0W		0.3W 0.7W	
No load Power Consumption	230VAC			100mW	
Input Frequency Range	AC Input		47Hz		63Hz
Minimum Load			0%		
Power Factor	115VAC 230VAC		0.6 0.5		
Start-up Time				150ms	
Rise Time				100ms	
Hold-up Time	115VAC 230VAC		12ms 50ms		
Internal Operating Frequency	100% load at nominal Vin			100kHz	
Output Ripple and Noise <sup>(5)</sup>	20MHz BW	5Vout others			200mVp-p 1% of Vout

#### Notes:

- Note3: The products were submitted for safety files at AC-Input operation (90-264VAC)
- Note4: Output power derating for Line-input of less than 90VAC (derate linearly from 100% at 90VAC to 80% at 80VAC)
- Note5: Measurements are made with a 0.1µF MLCC & 10µF E-cap in parallel across output. (low ESR)

### Efficiency vs. Load

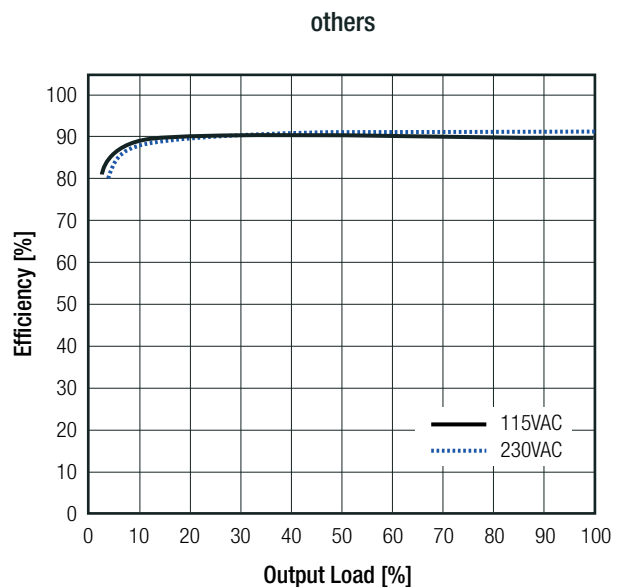
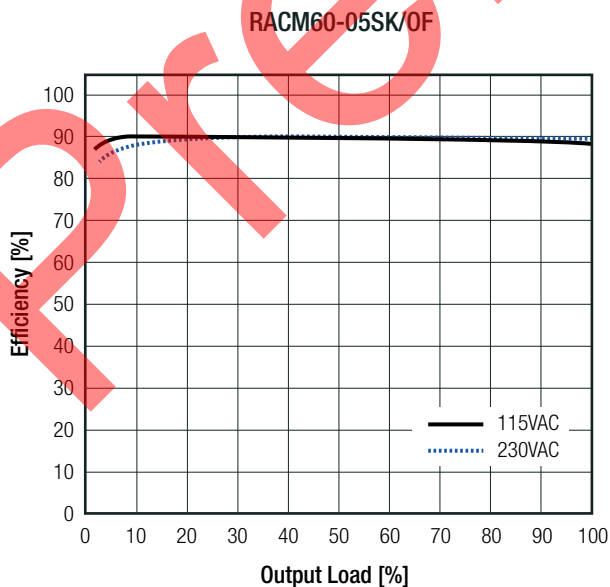

**Specifications** (measured @ Ta= 25°C, nom. Vin, full load and after warm-up unless otherwise stated)

### REGULATIONS

Parameter	Condition	Value	
Output Accuracy		±2.0% typ.	
Line Regulation	low line to high line	±0.05% typ.	
Load Regulation <sup>®</sup>	10% to 100% load	5Vout	1.5% typ.
		12, 15Vout	0.5% typ.
		24, 36, 48Vout	0.1% typ.
Transient Response	25% load step change	3.0% max.	
	recovery time	500µs max.	

**Notes:**

Note6: Operation below 10% load will not harm the converter, but specifications may not be met

### Deviation vs. Load

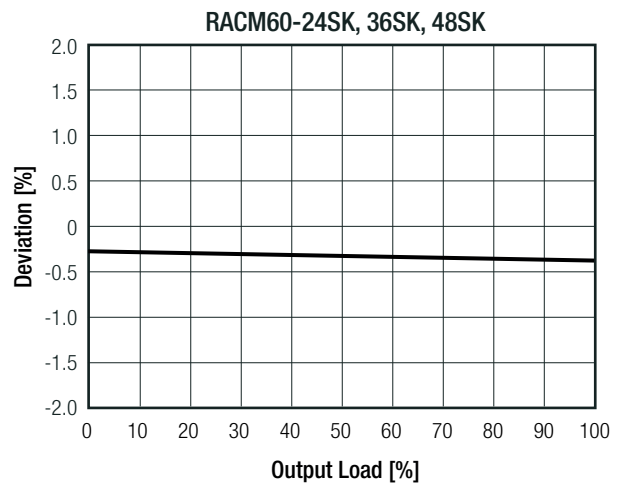
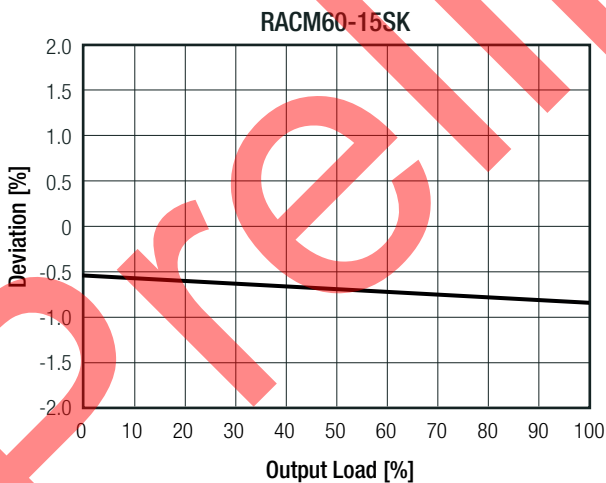
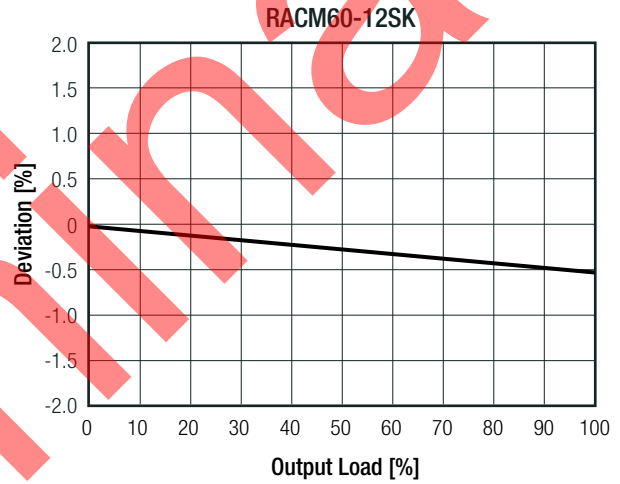
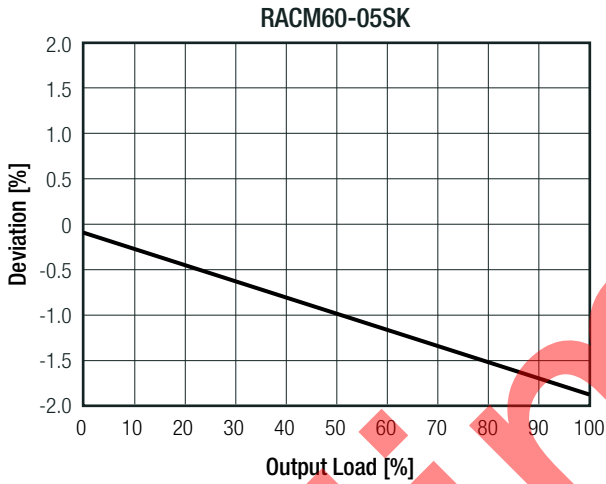

### PROTECTIONS

Parameter	Type	Value
Input Fuse	internal	T3.15A, slow blow type
Short Circuit Protection (SCP)		hiccup, auto recovery
Over Voltage Protection (OVP)		105% - 120%, auto recovery
Over Voltage Category (OVC)		OVCII
Over Current Protection (OCP)		130% - 180%, hiccup mode

continued on next page

### Specifications (measured @ Ta= 25°C, nom. Vin, full load and after warm-up unless otherwise stated)

Parameter	Type	Value
Thermal Shutdown	TC point IC 101	+130°C, restart after cool down
Class of Equipment		Class II
Isolation Voltage (safety certified) <sup>(7)</sup>	I/P to O/P   1 minute	4kVAC
Isolation Resistance	I/P to O/P, V <sub>ISO</sub> = 500VDC	1GΩ min.
Isolation Capacitance	I/P to O/P, 100KHz/0.1V	100pF max.
Insulation Grade		reinforced
Means of Protection	319VAC working voltage	2MOPP

**Notes:**

Note7: For repeat Hi-Pot testing, reduce the time and/or the test voltage

### ENVIRONMENTAL

Parameter	Condition	Value
Operating Temperature Range	@ natural convection 0.1m/s   refer to "Derating Graph"	-40°C to +85°C
Temperature Coefficient		±0.02%/K
Operating Altitude <sup>(8)</sup>	according to IEC60601-1 / IEC62368-1	4000m/5000m
Operating Humidity	non-condensing	95% max.
Pollution Degree		PD2
Vibration	according to MIL-STD-202G	10-500Hz, 2G 10min./1cycle, period 60min. along x,y,z axes
MTBF	according to MIL-HDBK-217F, G.B.	+25°C >900 x 10 <sup>3</sup> hours +40°C >726 x 10 <sup>3</sup> hours
Design Lifetime	nom. Vin= 230VAC, +40°C	>42 x 10 <sup>3</sup> hours

**Notes:**

Note8: Recognized by safety agency for safe operation up to 4000/5000m. High altitude operation may impact the performance and lifetime. Please contact RECOM tech support for advice

### Derating Graph

(@ Chamber and natural convection 0.1m/s)

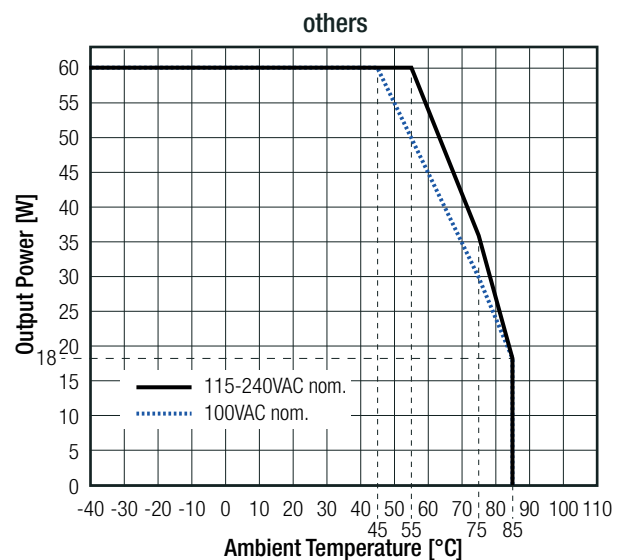
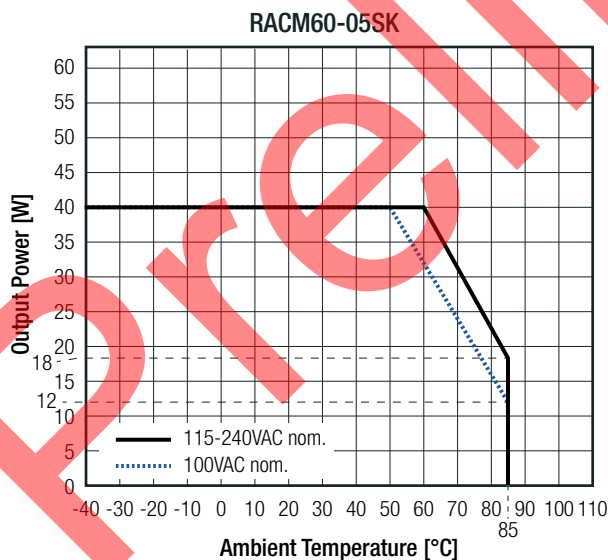

### SAFETY AND CERTIFICATIONS

Certificate Type (Safety)	Report Number	Standard
Medical electrical equipment Part 1: General requirements for basic safety and essential performance	E511305-D1000 -1/A0/C0-UL	CAN/CSA-C22.2 No. 60601-1:14, 3rd Edition ANSI/AAMI ES60601-1:2005 + A2:2010/R2012
Audio/Video, information and communication technology equipment - Safety requirements (CB Scheme)	pending	IEC62368-1:2014 2nd Edition

continued on next page

**Specifications** (measured @ Ta= 25°C, nom. Vin, full load and after warm-up unless otherwise stated)

Certificate Type (Safety)	Report Number	Standard
Audio/Video, information and communication technology equipment - Safety requirements (LVD)	pending	EN62368-1
Household and similar electrical appliances – Safety – Part 1: General requirements (LVD)	pending	IEC60335-1:2010 5th Edition + AM1:2013 EN60335-1:2012 + A11:2014
Measurement methods for electromagnetic fields of household appliances and similar apparatus with regard to human exposure		EN62233:2008
Safety of power transformers, power supplies, reactors & similar products for supply voltages up to 1100 V (CB Scheme)	pending	IEC61558-1:2005 2nd Edition + A1:2009
Safety of power transformers, power supplies, reactors & similar products for supply voltages up to 1100V	pending	EN61558-1:2005 + A1:2009
Safety of power transformers, power supplies, reactors & similar products for supply voltages up to 1100 V Part 2: Particular requirements (CB Scheme)	pending	IEC61558-2-16:2009 1st Edition + A1:2013
Safety of power transformers, power supplies, reactors & similar products for supply voltages up to 1100 V Part 2: Particular requirements	pending	EN61558-2-16:2009 + A1:2013
RoHS2+		RoHS 2011/65/EU + AM2015/863
EMC Compliance (Medical)	Condition	Standard / Criterion
Medical electrical equipment - Part 1-2: General requirements for basic safety and essential performance - Collateral standard: Electromagnetic compatibility - Requirements and tests		EN60601-1-2, Class B, Group 1
ESD Electrostatic discharge immunity test	Air: ±2, 4, 8, 15kV Contact: ±2, 4, 8kV	EN61000-4-2:2009, Criteria B
Radiated, radio-frequency, electromagnetic field immunity test	10V/m (80-2700 MHz)	EN61000-4-3:2006+A2:2010, Criteria A
Fast Transient and Burst Immunity	AC Port: L-N 2kV	EN61000-4-4:2012, Criteria B
Surge Immunity	AC Port: L-N 0.5kV	EN61000-4-5:2014, Criteria B
Immunity to conducted disturbances, induced by radio-frequency fields	AC Port: 3Vrms (0.15-80MHz)	EN61000-4-6:2014, Criteria A
Power Magnetic Field Immunity	30A/m	EN61000-4-8:2010, Criteria A
Voltage Dips and Interruptions	Dips: 100% (0.5P 1.0P) 30% Interruptions: 100%	EN61000-4-11:2004, Criteria B
EMC Compliance (Multimedia)	Condition	Standard / Criterion
Electromagnetic compatibility of multimedia equipment - Emission requirements		EN55032, Class B
Electromagnetic compatibility of multimedia equipment - Immunity requirements		EN55035
Low voltage power supplies, d.c. output Part 3: Electromagnetic compatibility (EMC)		EN/IEC61204-3:2018, Class B
ESD Electrostatic discharge immunity test	Air: ±2, 4, 8kV Contact: ±2, 4kV	EN61000-4-2:2009, Criteria B
Radiated, radio-frequency, electromagnetic field immunity test	10 V/m (80-1000 MHz) 3 V/m (1400-2000MHz) 1 V/m (2000-2700MHz)	EN61000-4-3:2006+A2:2010, Criteria A
Fast Transient and Burst Immunity	AC Port L, N, L-N 1kV	EN61000-4-4:2004+A1:2010, Criteria B
Surge Immunity	AC Port L-N 0.5kV	EN61000-4-5:2014+A1:2017, Criteria B
Immunity to conducted disturbances, induced by radio-frequency fields	AC Port 3, 10Vrms (0.15-80MHz)	EN61000-4-6:2014+A1:2015, Criteria A
Power Magnetic Field Immunity	1A/m	EN61000-4-8:2010, Criteria A
Voltage Dips and Interruptions	Dips: 100% 30% Interruptions:100%	EN61000-4-11, Criteria B EN61000-4-11, Criteria C EN61000-4-11, Criteria C
Limitations on the amount of electromagnetic interference allowed from digital and electronic devices		FCC 47 CFR Part 15 Subpart B
Limitations on the amount of electromagnetic interference allowed from digital and electronic devices, industrial, scientific, and medical equipment		FCC 47 CFR Part 18
Limits of Voltage Fluctuations & Flicker		EN61000-3-3:2013

**Specifications** (measured @ Ta= 25°C, nom. Vin, full load and after warm-up unless otherwise stated)

### DIMENSION AND PHYSICAL CHARACTERISTICS

Parameter	Type	Value
Material	PCB	FR4 (UL94-V0)
Dimension (LxWxH)	"/OF" type	78.4 x 53.0 x 31.5mm
	"/OF/PCB" type	78.4 x 53.0 x 35.4mm
	"/OF/2x4" type	101.6 x 53.0 x 31.5mm
Weight	"/OF" and "/OF/PCB" types	111g typ.
	"/OF/2x4" type	120g typ.

Dimension Drawing "/OF" (mm)

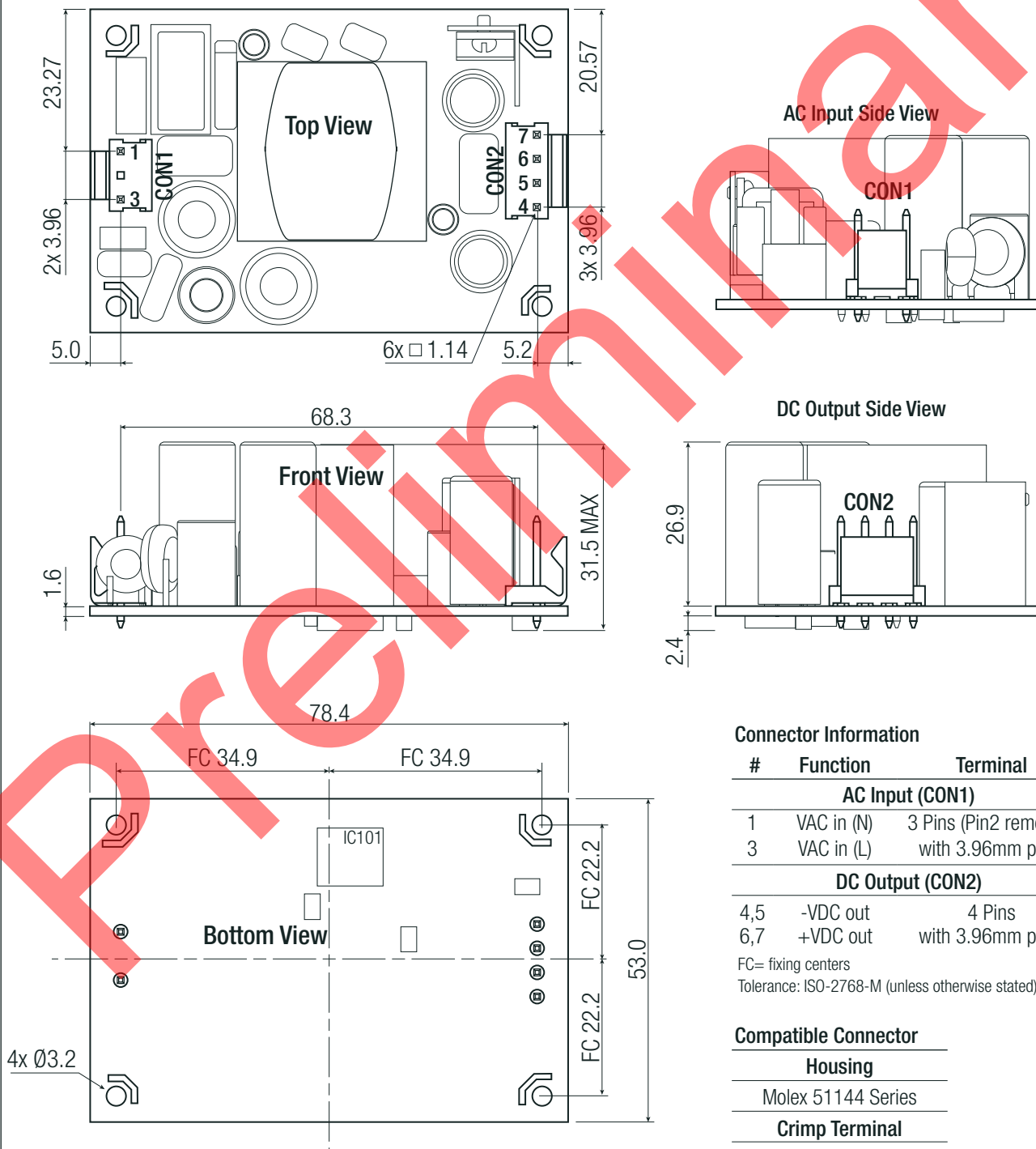

#### Connector Information

#	Function	Terminal
<b>AC Input (CON1)</b>		
1	VAC in (N)	3 Pins (Pin2 removed)
3	VAC in (L)	with 3.96mm pitch
<b>DC Output (CON2)</b>		
4,5	-VDC out	4 Pins
6,7	+VDC out	with 3.96mm pitch

FC= fixing centers

Tolerance: ISO-2768-M (unless otherwise stated)

#### Compatible Connector

##### Housing

Molex 51144 Series

##### Crimp Terminal

Molex 50539

continued on next page

**Specifications** (measured @ Ta= 25°C, nom. Vin, full load and after warm-up unless otherwise stated)

Dimension Drawing "/OF/2x4" (mm)

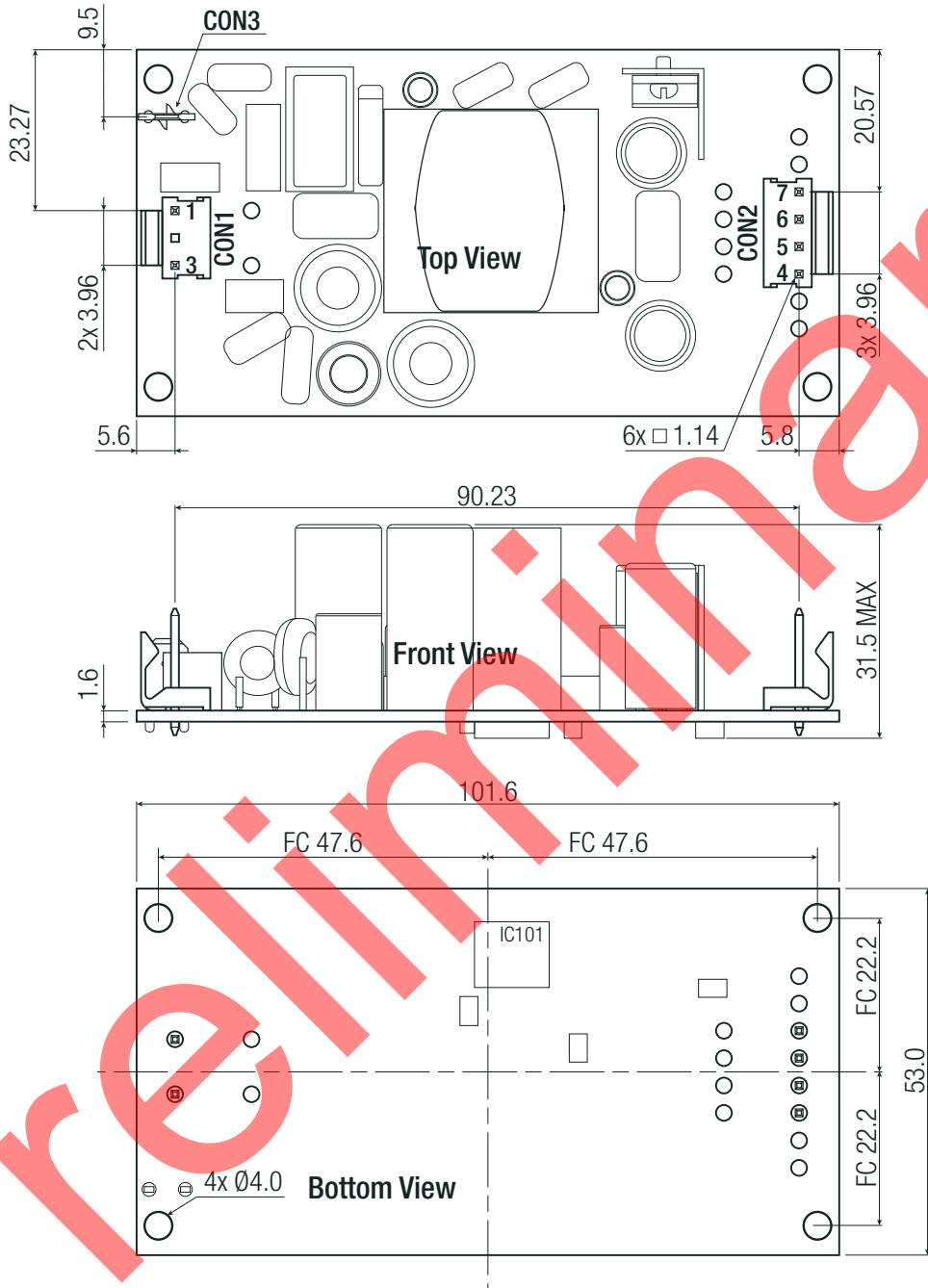

AC Input Side View

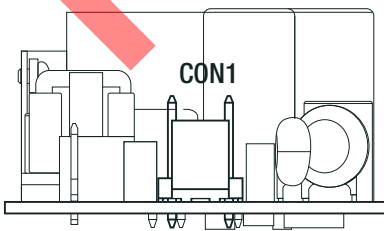

DC Output Side View

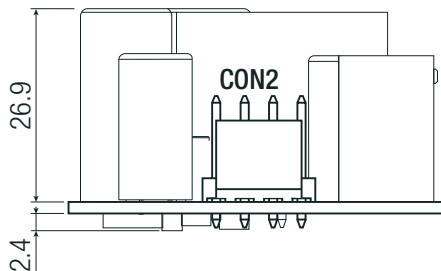

### Connector Information

#	Function	Terminal
<b>AC Input (CON1)</b>		
1	VAC in (N)	3 Pins (Pin2 removed)
3	VAC in (L)	with 3.96mm pitch
<b>DC Output (CON2)</b>		
4,5	-VDC out	4 Pins
6,7	+VDC out	with 3.96mm pitch
<b>FE (CON3)</b>		
8	functional earth	fast on

FC= fixing centers

Tolerance: ISO-2768-M (unless otherwise stated)

continued on next page

**Specifications** (measured @ Ta= 25°C, nom. Vin, full load and after warm-up unless otherwise stated)

Dimension Drawing "/OF/PCB" (mm)

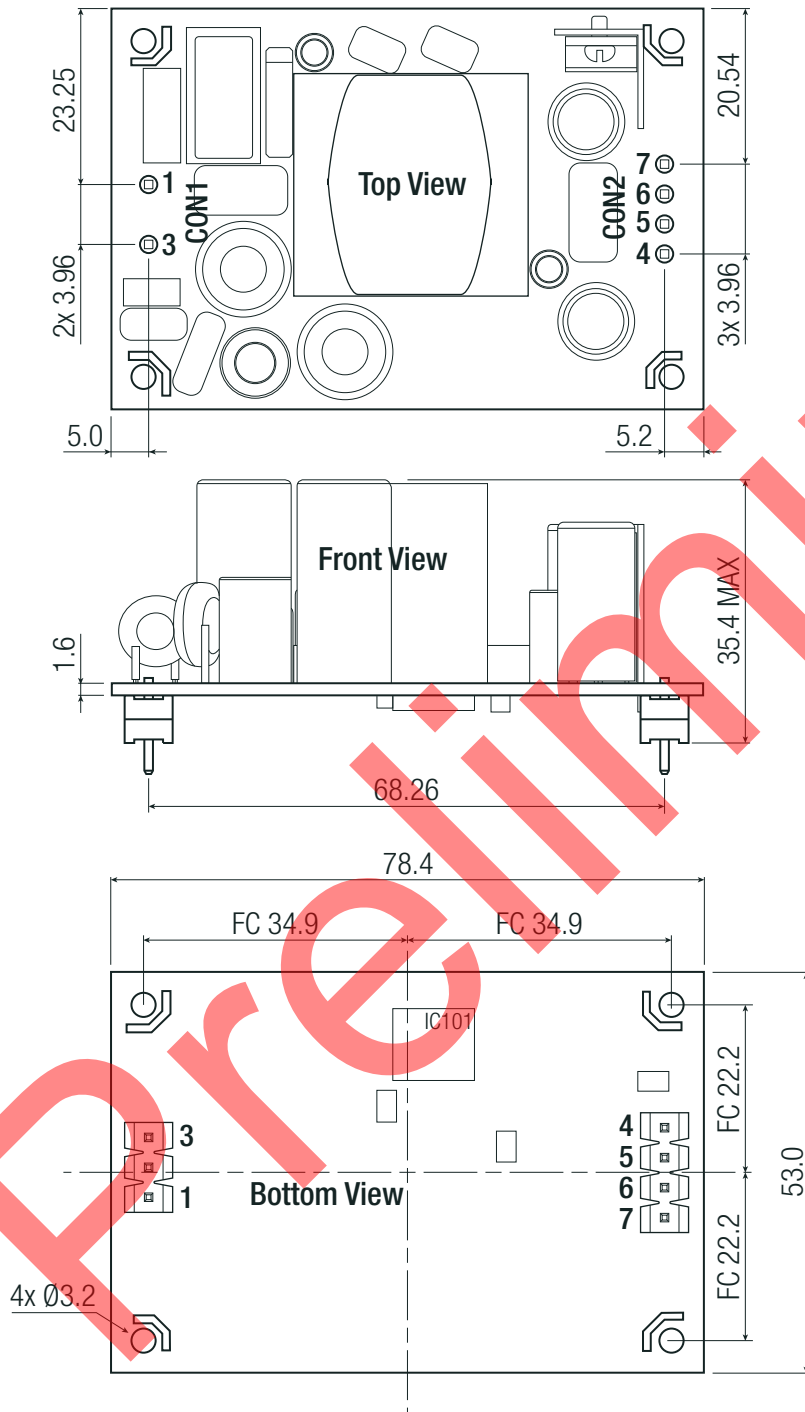

### Pin-header Information

#	Function	Terminal
<b>AC Input (CON1)</b>		
1	VAC in (N)	3 Pins (Pin2 removed)
3	VAC in (L)	with 3.96mm pitch
<b>DC Output (CON2)</b>		
4,5	-VDC out	4 Pins
6,7	+VDC out	with 3.96mm pitch

FC= fixing centers

Tolerance: ISO-2768-M (unless otherwise stated)



**Specifications** (measured @  $T_a = 25^\circ\text{C}$ , nom.  $V_{in}$ , full load and after warm-up unless otherwise stated)

### APPLICATION AND INSTALLATION

#### Mounting

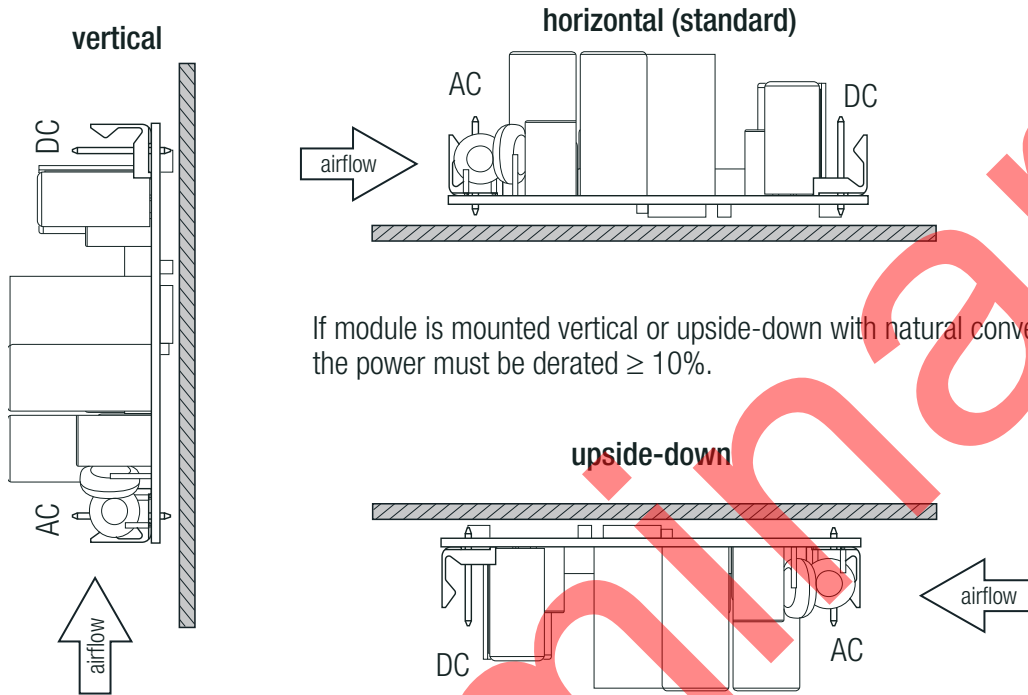

If module is mounted vertical or upside-down with natural convection cooling, the power must be derated  $\geq 10\%$ .

#### Blockdiagram ("OF" and "OF/PCB")

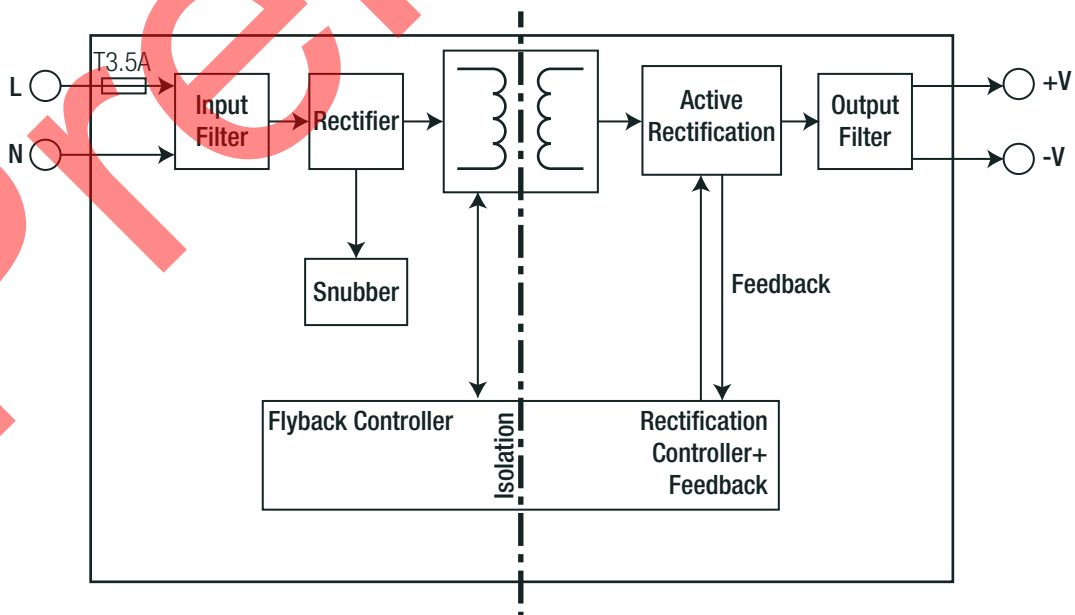

continued on next page

**Specifications** (measured @ Ta= 25°C, nom. Vin, full load and after warm-up unless otherwise stated)

### APPLICATION AND INSTALLATION

Blockdiagram (“/OF/2x4”)

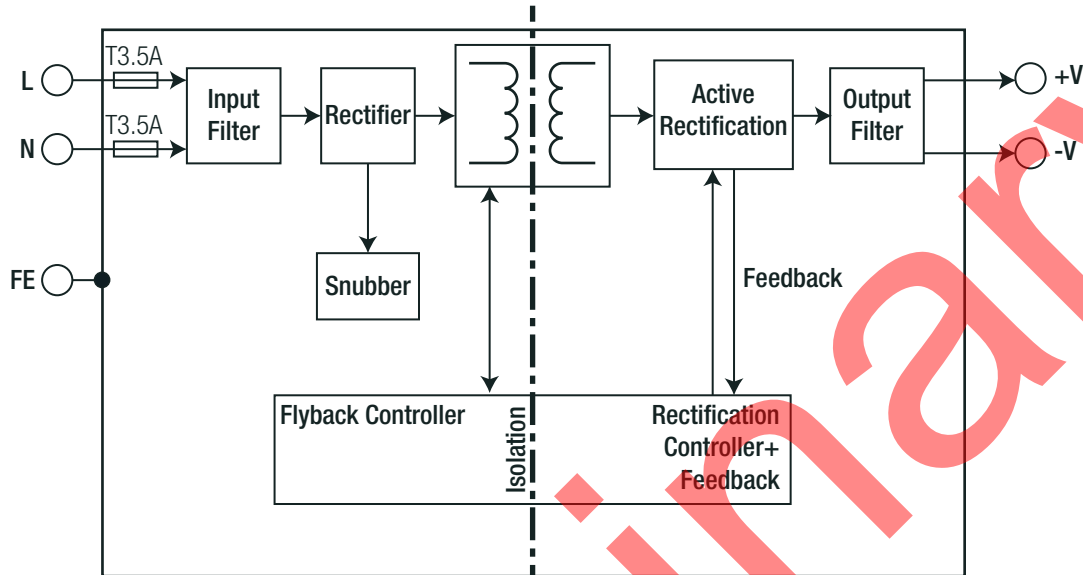

### PACKAGING INFORMATION

Parameter	Type	Value
Packaging Dimension (LxWxH)	“/OF” type	65.0 x 55.0 x 95.0mm
	“/OF/2x4” type	cardboard box (single pack) 65.0 x 50.0 x 110.0mm
	“/OF/PCB-T” type	single tray (carton) 365.0 x 210.0 x 56.0mm
	“/OF-CTN” type	tray in carton (project pack) 375.0 x 220.0 x 245.0mm
Packaging Quantity	“/OF” type and “/OF/2x4” type	1pcs
	“/OF/PCB-T” type	12pcs
	“/OF-CTN” type, MOQ= 1152pcs	48pcs
Storage Temperature Range		-40°C to +90°C
Storage Humidity	non-condensing	95% max.

The product information and specifications may be subject to changes even without prior written notice. The product has been designed for various applications; its suitability lies in the responsibility of each customer. The products are not authorized for use in safety-critical applications without RECOM's explicit written consent. A safety-critical application is an application where a failure may reasonably be expected to endanger or cause loss of life, inflict bodily harm or damage property. The applicant shall indemnify and hold harmless RECOM, its affiliated companies and its representatives against any damage claims in connection with the unauthorized use of RECOM products in such safety-critical applications.