

13 12 11 10 9 8 7 6 5 4 3 2 1

J
I
H
G
F
E
D
C
B
A

J
I
H
G
F
E
D
C
B
A

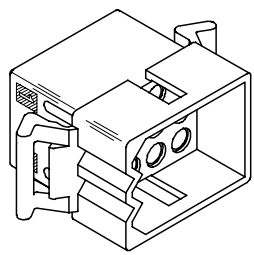
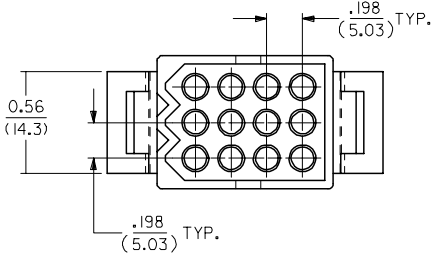
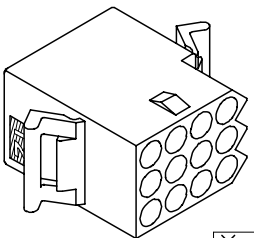
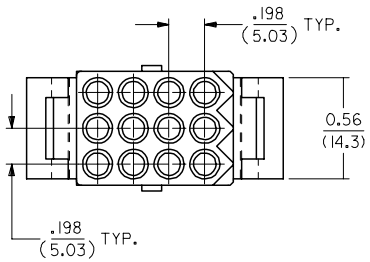
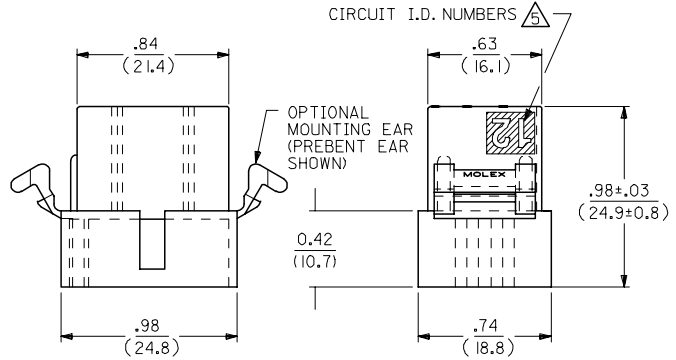
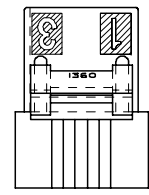
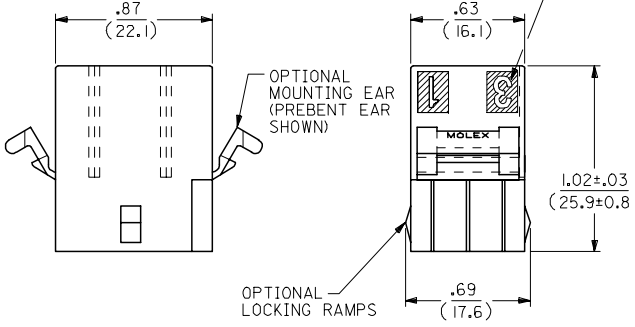
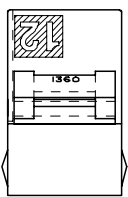
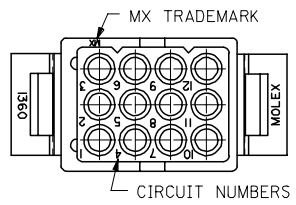
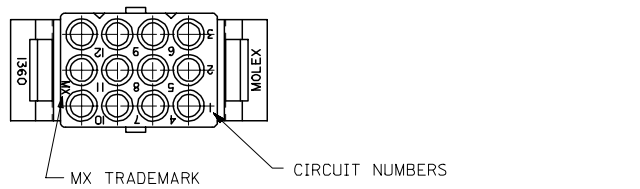

RECEPTACLE

PLUG

2	AE1
1	AE1
SHT/REV	

UPDATE TITLE BLOCK EC NO: UCP2006-0080 DRAWN: JLOME CHKD: 2005/07/20 APPR: FSM TH 2005/07/20	QUALITY SYMBOLS 	GENERAL TOLERANCES (UNLESS SPECIFIED)		DIMENSION STYLE IN/MM		SCALE 2:1	DESIGN UNITS INCH	THIRD ANGLE PROJECTION	
		4 PLACES ± .005 ± .010 3 PLACES ± .005 ± .010 2 PLACES ± .005 ± .010 1 PLACE ± .005 ± .010	mm INCH	DRAWN BY KBW	DATE 3/1/89	TITLE .093/(2.36) HOUSINGS PLUG AND RECEPTACLE 12 CKT, .198/(5.03)CTR.			
		ANGULAR ± 2 °	APPROVED BY RAS	DATE 3/1/89	MATERIAL NO. DOCUMENT NO. MOLEX INCORPORATED				
		DRAFT WHERE APPLICABLE MUST REMAIN WITHIN DIMENSIONS		SEE CHART		SIZE C		SD-1360-*	

12 11 10 9 8 7 6 5 4 3 2 1

PLUG		
ORDER NO	ENG NO	
03-09-2121	I360-P	
03-09-2122	I360-P1	
03-09-7121	I360-PBK	
03-09-7122	I360-P1BK	OBSOLETE

RECEPTACLE	
ORDER NO	ENG NO
03-09-1121	I360-R
03-09-1122	I360-R1
03-09-1125	I360-R2
03-09-1126	I360-R3
03-09-6121	I360-RBK
03-09-6122	I360-R1BK
03-09-6125	I360-R2BK
03-09-6126	I360-R3BK
03-09-6123	I360-R1RD
03-09-6124	I360-R1YW

LEGEND: PLUG

I360-P***

P = PLUG

BLANK = WITHOUT EARS

I = WITH MOUNTING EARS

COLOR:

BLANK = NATURAL COLOR

AM = AMBER BK = BLACK BU = BLUE

BN = BROWN GY = GRAY GN = GREEN

OR = ORANGE RD = RED YW = YELLOW

LEGEND: RECEPTACLE

I360-R***

R = RECEPTACLE

BLANK = WITH PREBENT EARS ONLY

1 = WITHOUT EARS/WITHOUT LOCKING RAMP

2 = WITH PREBENT EARS & LOCKING RAMP

3 = WITH LOCKING RAMP ONLY

COLOR:

BLANK = NATURAL COLOR

AM = AMBER BK = BLACK BU = BLUE

BN = BROWN GY = GRAY GN = GREEN

OR = ORANGE RD = RED YW = YELLOW

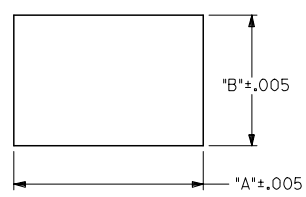
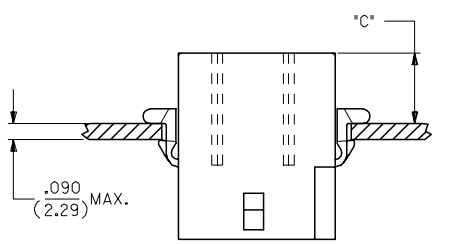

RECOMMENDED PANEL OPENING

HOUSING	DIM. 'A'	DIM. 'B'	'C' PREBENT EAR	'C' STANDARD EAR
PLUG	1.155/(29.34)	.760/(19.30)	.40/(10.2)	.36/(9.1)
RECEPT.	1.050/(26.67)	.725/(18.42)	.41/(10.4)	.37/(9.4)

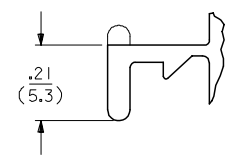

DETAIL A
.093/(2.36) STANDARD MOUNTING EAR
(SCALE 4:1)

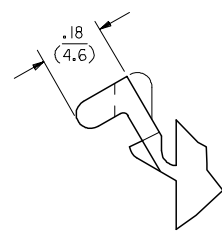
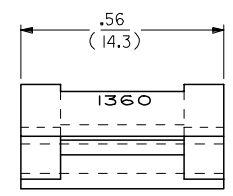

DETAIL B
.093/(2.36)PREBENT MOUNTING EAR
(SCALE 4:1)

- NOTES:
1. MATERIAL: NYLON TYPE 6/6, UL94V-2
 2. FINISH: N/A
 3. PRODUCT SPECIFICATION: PS-02-09, PS-43660-9999
 4. PACKAGING SPECIFICATION: PK-1360-001

- CIRCUIT I.D. NUMBERS ON SIDE OF HOUSING APPEAR ON PARTS FROM TOOLS BUILT AFTER 10/22/91
- WHERE DENOTED IN CHART, TOOLS ARE BUILT WITH PREBENT MOUNTING EARS PER DETAIL B AND SUPERSEDE ALL TOOLS PREVIOUSLY BUILT WITH THE STANDARD EARS.

UPDATE TITLE BLOCK EC NO: UCP2006-0080 DRAWN: JLOME CHKD: 2005/07/20 APPR: FSM TH 2005/07/21 REVISIONS A1	QUALITY SYMBOLS = 0 = 0	GENERAL TOLERANCES (UNLESS SPECIFIED)		DIMENSION STYLE IN/MM		SCALE 2:1	DESIGN UNITS INCH	THIRD ANGLE PROJECTION
		4 PLACES ± .010 ± .010	DRAWN BY KBW	DATE 3/1/89	TITLE .093/(2.36) HOUSINGS PLUG AND RECEPTACLE 12 CKT, .198/(5.03)CTR.			
		3 PLACES ± .010 ± .014	CHECKED BY RW	DATE 3/1/89	MOLEX INCORPORATED			
		2 PLACES ± 0.25 ± .014 1 PLACE ± 0.35 ± .014 ANGULAR ± 2 °	APPROVED BY RAS	DATE 3/1/89	MATERIAL NO. SD-1360-* DOCUMENT NO. SHEET NO. 2 OF 2			
DRAFT WHERE APPLICABLE MUST REMAIN WITHIN DIMENSIONS		SEE CHART		THIS DRAWING CONTAINS INFORMATION THAT IS PROPRIETARY TO MOLEX INCORPORATED AND SHOULD NOT BE USED WITHOUT WRITTEN PERMISSION				