

Contact arrangement

ARRANGEMENT	20-14	22-12	22-13	22-34	24-12
CONTACT SIZE	2/8 , 3/12	2/8 , 3/16	4/12 , 1/16	3/12 , 2/16	2/4 , 3/12
SERVICE RATING	A	D	D	D	A
ARRANGEMENT	24-17	28-5	32-1	32-2	32-79
CONTACT SIZE	2/12 , 3/16	2/4 , 1/12 , 2/16	2/0 , 3/12	3/4 , 2/16	4/4 , 1/8
SERVICE RATING	D	D	A=E ; B,C,D,E=D	E	D
ARRANGEMENT	40-A3	40-A5			
CONTACT SIZE	1/0M , 2/0 , 2/12	3/0 , 1/4 , 1/12			
SERVICE RATING	A	A			

6 CONTACTS

ARRANGEMENT	14S-6	18-06	18-12	20-8	20-17
CONTACT SIZE	16	4/12 , 2/16	16	2/8 , 4/16	5/12 , 1/16
SERVICE RATING	I	A	A	I	A
ARRANGEMENT	20-22	22-5	22-15	22-24	24-06
CONTACT SIZE	3/8 , 3/16	2/12 , 4/16	5/12 , 1/16	2/12 , 4/16	4/8 , 2/16
SERVICE RATING	A	D	D=E ; A,B,C,E,F=A	A,B,F=A ; C,D,E=D	D

CONTACT LEGEND

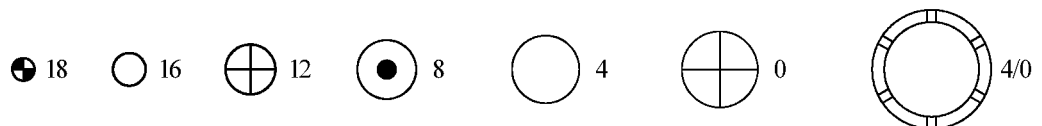

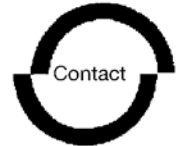

CM1 3106 A / CM1 3106 R
CM1 4106 A / CM1 4106 R
Straight plug

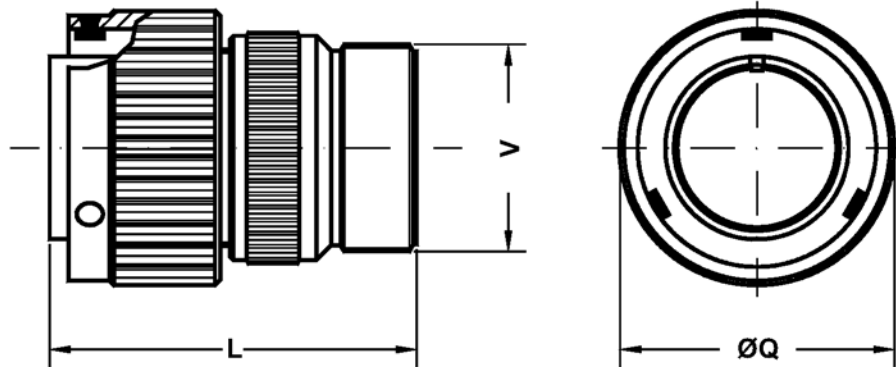

Shell size	L Max.	ØQ ±0.2	V thread
10 SL	44.0	22.6	0.6250 - 24UNEF
14 S	46.4	29.0	0.7500 - 20UNEF
16 S	46.4	31.6	0.8750 - 20UNEF
16	57.8	31.6	0.8750 - 20UNEF
18	57.8	36.2	1.0000 - 20UNEF
20	58.1	39.8	1.1875 - 18UNEF
22	58.1	43.0	1.1875 - 18UNEF
24	59.7	46.4	1.4375 - 18UNEF
28	66.2	53.0	1.4375 - 18UNEF
32	71.3	60.0	1.7500 - 18UNS
36	76.8	66.2	2.0000 - 18UNS
40	76.8	72.3	2.2500 - 16UN

Straight plug.
 Includes backshell for cable clamp
CM3057-XX A/B/C.
 No grommet supplied.

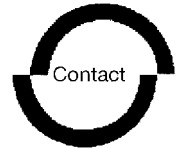

HOW TO ORDER

<u>FR</u>	<u>CM1</u>	<u>31</u>	<u>06</u>	<u>A</u>	<u>20-27</u>	<u>P</u>	<u>X</u>	<u>(...)</u>
<i>1</i>	<i>2</i>	<i>3</i>	<i>4</i>	<i>5</i>	<i>6</i>	<i>7</i>	<i>8</i>	<i>9</i>

- 1* Omitted : Standard
FR : Fire Resistant rubber
- 2* CM1 : Bayonet coupling
*CM4 : Bayonet coupling without stainless steel wear pins
- 3* 31 : Solder contacts
41 : Crimp contacts
- 4* Style : 00 - 01 - 02 - 03 - 030 - 05 - 06 - 07 - 070 - 078 - 08 - 26
- 5* Class : A - F - G - GR - RS - SP - Y
- 6* Contact arrangement
- 7* P : Pin contacts
S : Socket contacts
P/S : Contacts for 02PP connectors
- 8* W - X - Y - Z : Alternate positions of the inserts
- 9* Modifications (see the next page)

* Only for receptacles

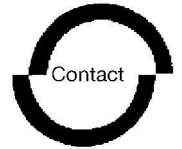

Technical characteristics

Metal parts

Aluminium alloy with Cadmium free surface coatings with an olive drab passivation .

Contacts

The following contact types are available :
copper alloy with silver plating (Std) or gold plating (available on request).

Insulating parts

High insulation synthetic rubber resistant to oils and high range of temperatures (-55°C to +125°C) in accordance with MIL-R-3065.
Are also available in fire resistant and halogen free materials.

Contacts

Contact size	Rated current at 20°C	Max. Contact resist.	Wire size
18	7.5 A	12.0 mΩ	20+26 AWG
16	22 A	6.0 mΩ	16+22 AWG
12	41 A	3.0 mΩ	12-14 AWG
8	73 A	1.0 mΩ	8-10 AWG
4	135 A	0.5 mΩ	4-6 AWG
0	245 A	0.3 mΩ	0+2 AWG
4/0	350 A	0.2 mΩ	4/0 AWG

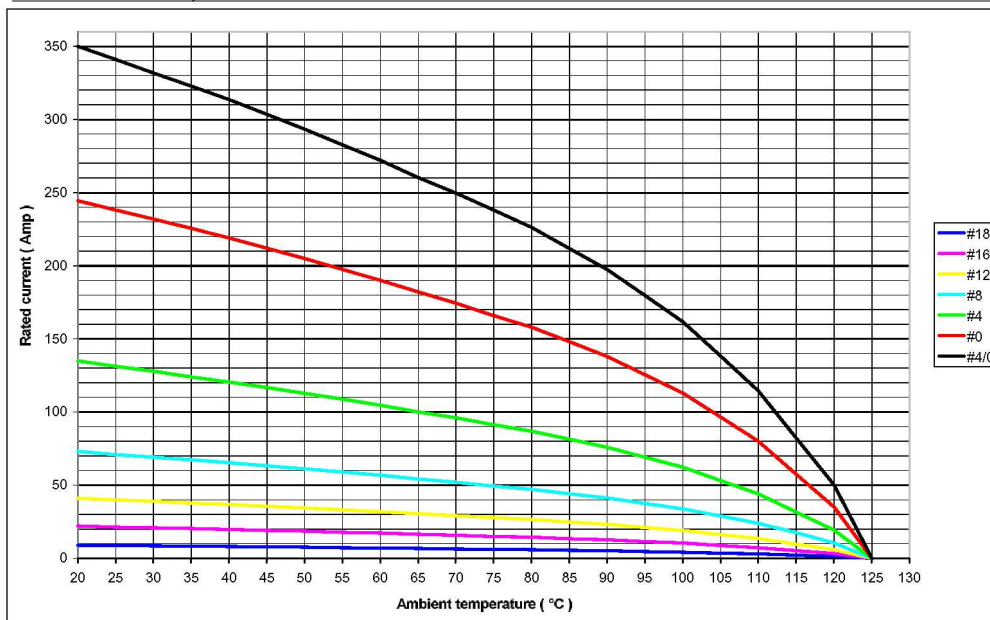

Service rating (Min insulating resistance : $\geq 5 \times 10^3 \text{ M}\Omega$)

Class	Operating voltage Vdc	Operating voltage VacRMS	Test voltage Vac RMS
INST.	250 V	200 V	1000 V
A	700 V	500 V	2000 V
D	1250 V	900 V	2800 V
E	1750 V	1250 V	3500 V
B	2450 V	1750 V	4500 V
C	4200 V	3000 V	7000 V



Pin contacts

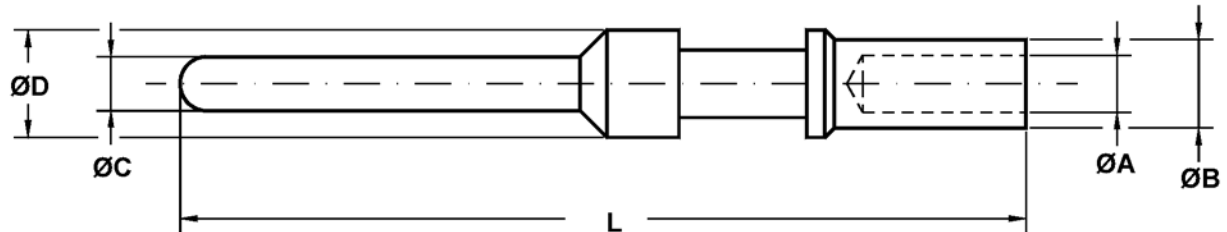

Contact P/N	Size	mm ²	AWG	A +0 -0.1	B +0 -0.1	C ±0.02	D +0 -0.1	L ±0.1
CM - 40579	18	0.15 / 0.6	26 / 20	1.30	1.93	1.40	2.2	29.60
CM - 40553	16S	1 / 1.5	18 / 16	1.70	2.60	1.58	3.2	26.65
CM - 40553 - 12	16S	0.6	20	1.20	2.60	1.58	3.2	26.65
CM - 40553 - 13	16S	0.15 / 0.6	26 / 20	1.30	1.93	1.58	3.2	26.65
CM - 40553 - 15	16S	1	18	1.50	2.60	1.58	3.2	26.65
CM - 40553 - 20	16S	2	14	2.00	2.90	1.58	3.2	26.65
CM - 40553 - 26	16S	3	12	2.50	3.80	1.58	3.2	26.65
CM - 40557	16	1 / 1.5	18 / 16	1.70	2.60	1.58	3.2	31.75
CM - 40557 - 08	16	0.15 / 0.2	26 / 24	0.85	1.55	1.58	3.2	31.75
CM - 40557 - 12	16	0.6	20	1.20	2.60	1.58	3.2	31.75
CM - 40557 - 13	16	0.15 / 0.6	26 / 20	1.30	1.93	1.58	3.2	31.75
CM - 40557 - 15	16	1	18	1.50	2.60	1.58	3.2	31.75
CM - 40557 - 20	16	2	14	2.00	2.90	1.58	3.2	31.75
CM - 40557 - 26	16	3	12	2.50	3.80	1.58	3.2	31.75
CM - 40557 - 32	16		32 / 28	0.45	1.95	1.58	3.2	31.75
CM - 40561	12	3	12	2.50	3.90	2.38	4.8	37.65
CM - 40561 - 12	12	0.6	20	1.20	2.60	2.38	4.8	37.65
CM - 40561 - 15	12	1	18	1.50	3.40	2.38	4.8	37.65
CM - 40561 - 20	12	1 / 2	18 / 14	2.00	3.80	2.38	4.8	37.65
CM - 40561 - 22	12	2.5		2.20	3.80	2.38	4.8	37.65
CM - 40561 - 30	12	4		3.00	4.80	2.38	4.8	37.65
CM - 40561 - 30M	12	4		3.30	4.20	2.38	4.8	37.65
CM - 40561 - 38	12	6		3.60	4.80	2.38	4.8	37.65
CM - 40792	8	6 / 8	8	4.50	6.90	3.59	7.8	42.00
CM - 40792 - 50	8	10		5.00	6.90	3.59	7.8	42.00
CM - 113474 - 4P	4	22	4	7.15	9.53	5.70	11.0	42.00
CM - 113474 - 1P	0	50 / 60	0	11.50	14.30	9.05	15.1	45.00
CM - 113474 - 0P	4/0	107	4/0	16.50	20.00	12.69	20.0	63.00

Please consult our sales department for other contacts or crimp tooling details .