

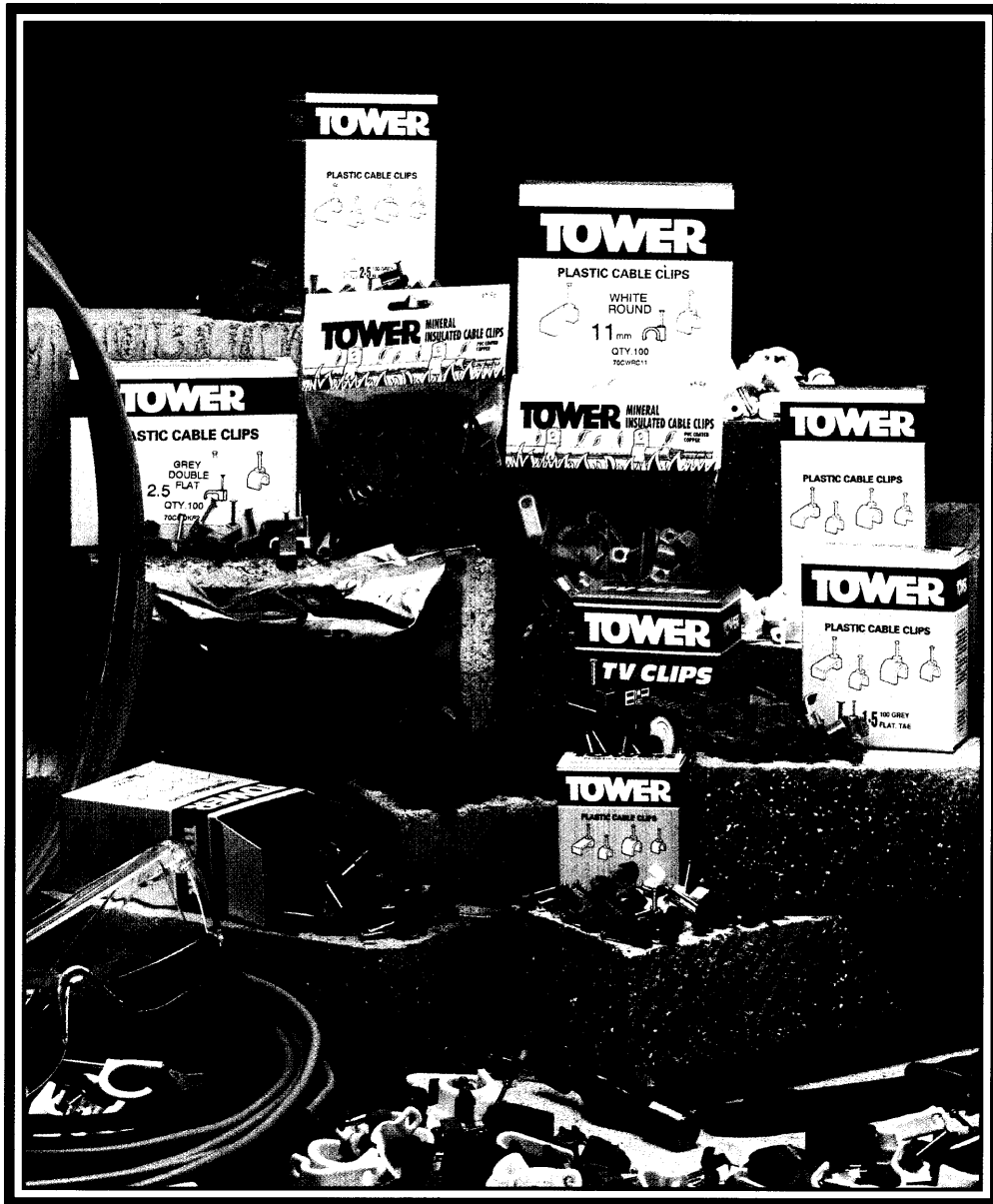

611-920 TO 612-030

TOWER

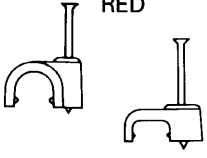
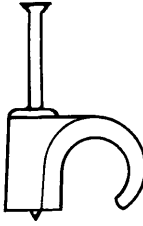
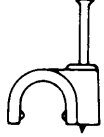

**A FULL RANGE OF
QUALITY CABLE FIXINGS**

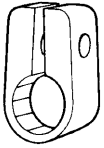
 <p>RED</p>	70CRRC6	Round	6.0mm	100		
	70CRRC7	Round	7.0mm	100		
	70CRRC8	Round	8.0mm	100		
	70CRRC9	Round	9.0mm	100		
	70CRRC10	Round	10.0mm	100		
	70CRKF1.0	Flat	1.0mm	100		
	70CRKF2.5	Flat	2.5mm	100		
	74CB04+	BLACK	4-5mm	100		
	74CB05+		5-6mm	100		
	74CB06+		6-7mm	100		
	74CB07+		7-8mm	100		
	74CB09+		9-10mm	50		
	74CB11+		11-12mm	50		
	74CB14+		14-15mm	50		
	74CB22+	22-24mm	50			
	74CW04+	WHITE	4-5mm	100		
	74CW05+		5-6mm	100		
	74CW06+		6-7mm	100		
	74CW07+		7-8mm	100		
	74CW09+		9-10mm	50		
	74CW11+		11-12mm	50		
74CW14+	14-15mm		50			
74CW22+	22-24mm	50				
 <p>ROUND ORANGE PLASTIC</p>	70CM16	2L1, 2L1.5, 3L1, 3L1.5, 4L1, 2L2.5, 4L1.5	2L1, 2L1.5, 3L1 2L2.5, 3L1.5, 4L1	100		
	70CM17	2L4, 7L1	2L4, 4L1.5, 7L1	100		
	70CM18	7L1.5	7L1.5	100		
	70CM19			100		
 <p>ROUND PVC COATED COPPER</p> <p>ORANGE, RED or WHITE = O, R, W</p>	64HJ 30/ 64HJ 32/ 64HJ 34/ 64HJ 37/		2L1 2L1.5, 3L1 2L2.5, 3L1.5, 4L1 3L2.5, 4L1.5	Pack Qty 50 50 50 50	Min. order Qty 100	
	BLACK POLYETHYLENE		63SWA05	12.7mm	50	100
		63SWA06	15.2mm	50	100	
		63SWA07	17.8mm	50	100	
63SWA08		20.3mm	50	100		
63SWA09		22.8mm	50	100		
63SWA10		25.4mm	50	100		
63SWA11		27.7mm	20	100		

TOWER



Tower Manufacturing is a business name of Glynwed Engineering Ltd. A member of the Glynwed International plc group of companies.

March 1995

TOWER MANUFACTURING
Glynwed Engineering Ltd.

Navigation Road, Diglis, Worcester WR5 3DE England
Telephone: 01905 763012 Telex: 338880
Fax: 01905 763610



Certificate No. FM00046

M.I. CLIPS

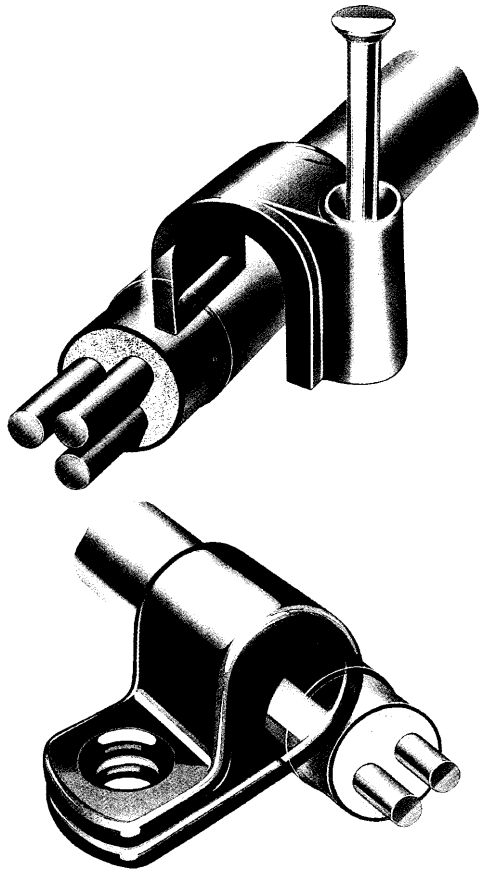

Tower's all embracing range of mineral-insulated clips, designed to secure single cables, covers all popular sizes.

Two types are available: round plastic (in orange), and PVC-coated copper (in red, white or orange).

2L1	64HJ30/ ...	Red, orange, white
2L1.5	64HJ32/ ...	Red, orange, white
2L2.5	64HJ34/ ...	Red, orange, white
3L1	64HJ32/ ...	Red, orange, white
3L1.5	64HJ34/ ...	Red, orange, white
3L2.5	64HJ37/ ...	Red, orange, white
4L1	64HJ34/ ...	Red, orange, white
4L1.5	64HJ37/ ...	Red, orange, white
64HJ30	6.4mm	Cable Diameter Covered
64HJ32	7.0mm - 7.1mm	Cable Diameter Covered
64HJ34	7.6mm - 7.9mm	Cable Diameter Covered
64HJ37	8.3mm - 8.8mm	Cable Diameter Covered

For selection of correct PVC coated copper clip, note size of cable and select either 30, 32, 34 or 37 and colour option Red, White, Orange ie. 2L1.5 red = 64HJ32/R.

CABLE CLEATS

Tower's non-corrosive cleats offer a strong and cost-effective single hole screw fixing for all steel wire armoured cables up to 25mm² three-core PVC/SWA/ PVC.

Available in black polyethylene and seven popular sizes, Tower cleats have a high resistance to impact and are stable in temperatures ranging from -35°C to +85°C.

Full details of Tower cable cleats are given in the selection chart.

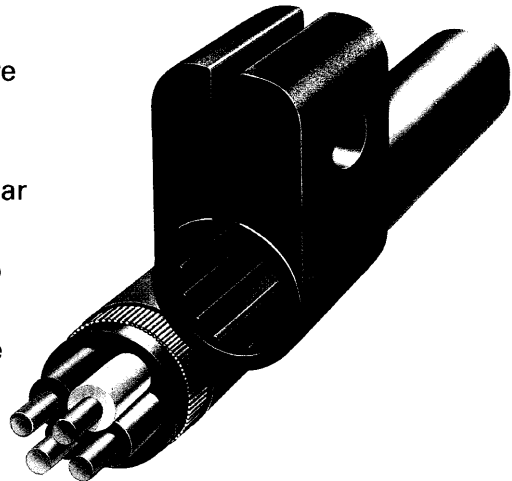





For selection of correct cleat, look for last digit on the chart ie. 16mm 4 core = Tower 63SWA11.

2	5	6	6	7	8	9	10
3	5	6	7	8	9	10	11
4	6	6	7	8	9	11	-
7	6	7	8	-	-	-	-
12	8	9	11	-	-	-	-
19	9	10	-	-	-	-	-

This chart is intended as a guide only.

TOWER CABLE CLIPS

	PARALLEL TWIN WHITE ONLY	70CPT 70CPT AD 70CPM 70CPM AD 70CSM 70CSM AD	Bell Wire Bell Wire Twin Figure ∞ 2812X Twin Figure ∞ 2812X Sheathed Twin 3192Y Sheathed Twin 3192Y	100 500 100 500 100 500	
	FLAT TWIN GREY OR WHITE	70C2C	Flat Twin 6192Y	1.0mm ² 100	
	FLAT TWIN & EARTH in GREY WHITE or BLACK	70CKF1.0 70CKF 1.5 70CKF 2.5 70CKF 4.0 70CKF 6.0 70CKF 6.0 AB 70CKF 10.0 70CKF 10.0 AB 70CKF 16.0 70CKF 16.0 AB	Flat Twin & Earth 6242Y	1.0mm ² 1.5mm ² 2.5mm ² 4.0mm ² 6.0mm ² (or) 6.0mm ² 10.0mm ² (or) 10.0mm ² 16.0mm ² (or) 16.0mm ²	100 100 100 100 100 50 100 50 100 50
	DOUBLE GREY, WHITE or BLACK	70CDKF 1.0 70CDKF 1.5 70CDKF 2.5 70CDKF 2.5 AB	Double Flat Twin & Earth 6242Y	1.0mm ² 1.5mm ² 2.5mm ² (or) 2.5mm ²	100 100 100 50
	THREE CORE & EARTH GREY or WHITE	70C3C & E	Three Core & Earth 6243Y	1.0mm ² & 1.5mm ²	100

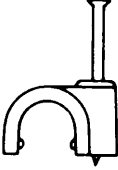
	ROUND in GREY WHITE BLACK or BROWN	70CRC 2.75 70CRC 2.75 AD 70CRC 3.5 70CRC 3.5 AD 70CRC 4 70CRC 4 AD 70CRC 5 70CRC 5 AD 70CRC 6 70CRC 7 70CRC 8 70CRC 9 70CRC 10 70CRC 10 AB 70CRC 11 70CRC 11 AB 70CRC 12 70CRC 12 AB 70CRC 14 70CRC 16	Round – Circular Nominal Size 2.75mm (or) 2.75mm 3.5mm (or) 3.5mm 4.0mm (or) 4.0mm 5.0mm (or) 5.0mm 6.0mm 7.0mm 8.0mm 9.0mm 10.0mm (or) 10.0mm 11.0mm (or) 11.0mm 12.0mm (or) 12.0mm 14.0mm 16.0mm	100 500 100 500 100 500 100 500 100 100 100 100 100 100 50 100 50 100 50 50 50
---	---	---	---	--

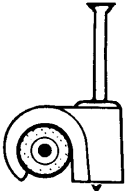
	72CT05+AT 72CT06+AT 72CT07+AT	BROWN BROWN BROWN	5.6mm 6-7mm 7-8mm	100 100 100
	72CB05+AT 72CB06+AT 72CB07+AT 72CB11+AT	BLACK BLACK BLACK BLACK	5-6mm 6-7mm 7-8mm 11-12mm	100 100 100 50
	72CW05+AT 72CW06+AT 72CW07+AT 72CW11+AT	WHITE WHITE WHITE WHITE	5-6mm 6-7mm 7-8mm 11-12mm	100 100 100 50

TV CLIPS

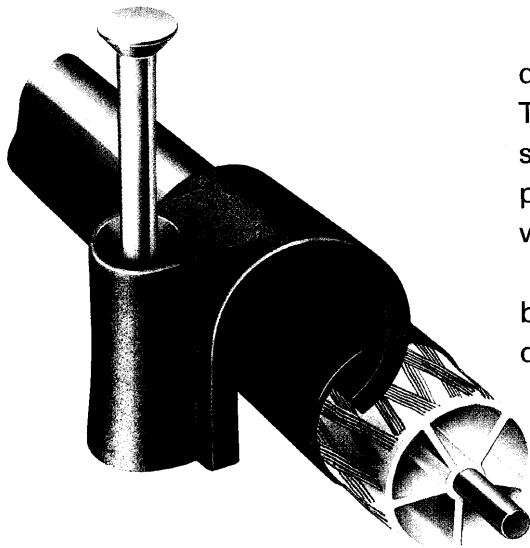

Designed to accommodate the wider dimensions of the latest coaxial cables, Tower TV clips are manufactured from a specially-selected grade of UV stabilised polypropylene which combines strength with elasticity.

The rounded body enables the clips to be attached to the cable prior to fixing, for quicker and easier installation.

Available in brown, black, white and four sizes, Tower TV clips are the ideal way to secure all antennae cables of 5mm to 12mm inclusive.

R.R. CLIPS

The Tower R.R. range of distinctive red clips has been developed exclusively for use in fire alarm installations, and offers a choice of round (6mm-10mm) or flat (1mm and 2.5mm).

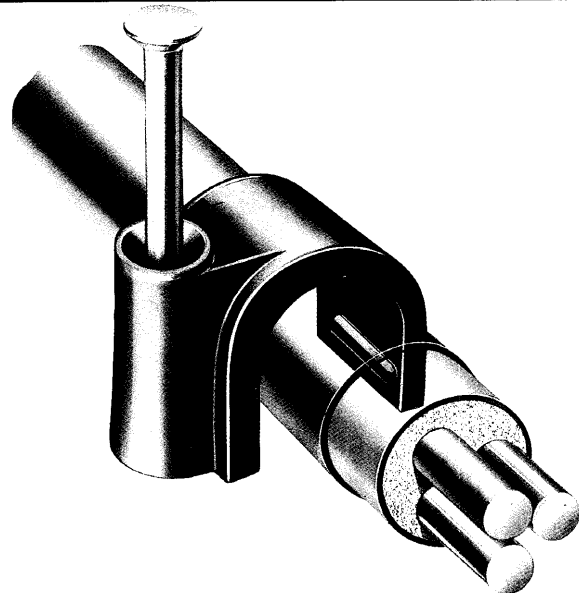

COMMUNICATION CLIPS

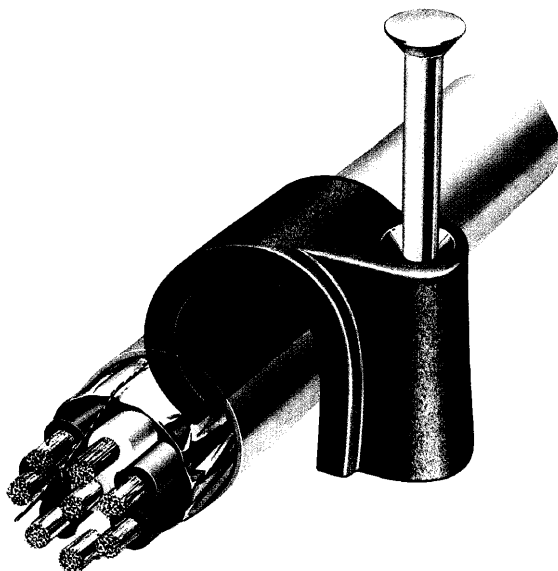

In anticipation of the growing need for more and more buildings to incorporate computer, communications and other sophisticated electronic installations, Tower have introduced a comprehensive range of clips dedicated for use with video, computer, multicore, multipair, data and signal cables.

Available in a range of sizes from 4mm to 24mm and a choice of white or black, Tower communication clips are pre-assembled with hardened steel pins.

This brochure describes and illustrates the very latest range of Tower cable fixing products.

It's a range which represents nearly one hundred years of continuous research, improvement and development, and is manufactured to the most stringent quality control standards using advanced production techniques. This is why Tower products still stand head and shoulders above the rest for innovative design, quality

and sheer value for money.

Today's Tower range of cable fixing products is also the most comprehensive in the UK. Virtually every type of application is catered for – including installation of even the most specialised cables, such as mineral-insulated, communication and steel-wire armoured.

So whatever the job, Tower won't let you down. Such is the strength of Tower.

FLAT CLIPS

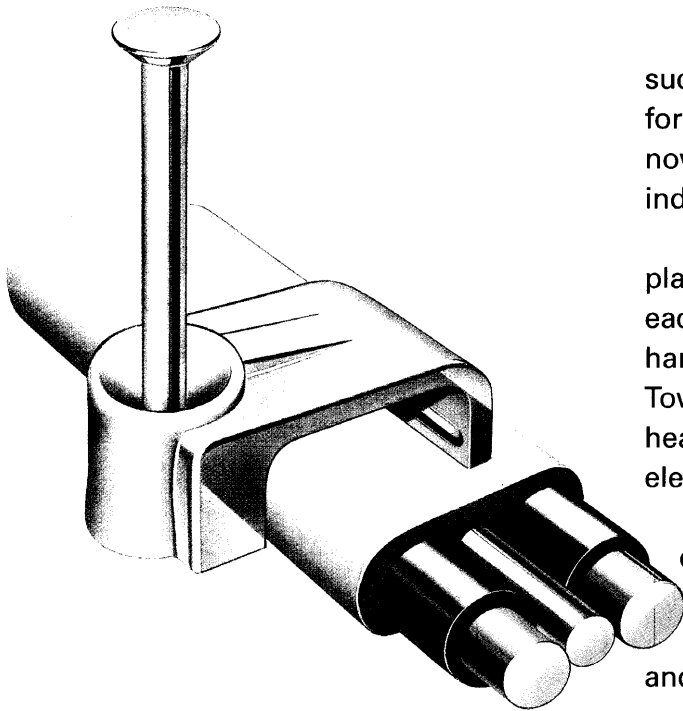

The flat clip is one of Tower's many successful innovations. Designed originally for use with twin and earth cables, it has now become the standard clip for the industry.

Made from specially-selected tough plastic to suit application, style and size – each clip includes a pre-assembled hardened steel pin. These pins are made by Tower from high-carbon steel wire that is heat treated prior to bright zinc electroplating.

The Tower range of flat clips encompasses just about every need – from the small, bell-wire P.T. clip to the much larger KF16 clip for 16.0mm² twin and earth cables.

ROUND CLIPS

This robust R.C. clip accommodates all manner of flexible cables which have a nominal size of between 2.75mm and 22mm inclusive. It is available in white, grey, black or brown.

Pack quantities vary, as shown in the selection chart.

