

CHIP RESISTORS

TYPE CR, Z

Construction

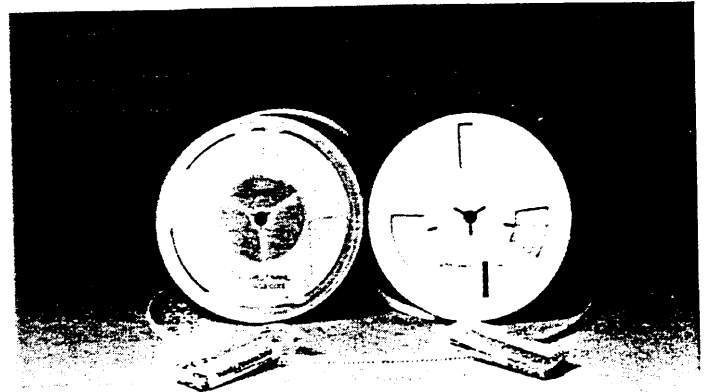
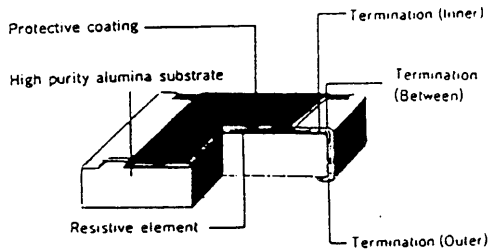

Dimensions and Power Rating

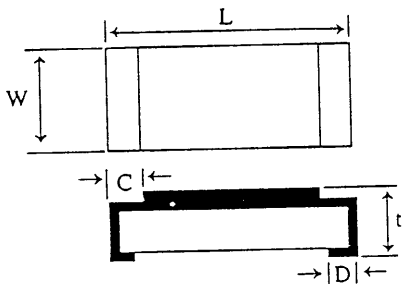

Derating Curve

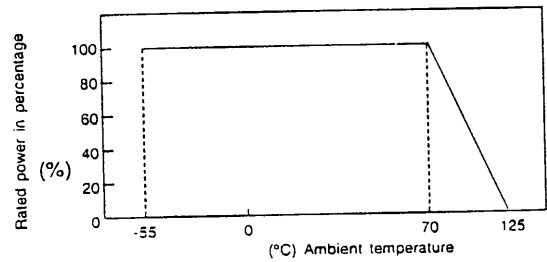

CR CHIP RESISTORS

Type	Power Rating (W)	Max. Working Voltage(V)	Max. Overload Voltage(V)	Tolerance (%)	Resistance Range(Ω)	T.C.R. (ppm/°C)	Note	Dimension (mm)				
								L	W	C	D	t
CR 16	0.063	50	100	±5 ±10	10 - 1M 4.7 - 1M	EIAJ-RC -2690	-	1.6±0.2	0.8±0.2	0.3±0.2	0.3±0.2	0.4-0.55
* → CR 10	0.1	100	200	±1	100 - 1M	±100	★ ★	2.0 ^{+0.2} _{-0.1}	1.25 ^{+0.2} _{-0.1}	0.4±0.2	0.3 ^{+0.2} _{-0.1}	0.4-0.55
CR 6	0.167			±2	10 - 1M							
CR 8	0.125	200	400	±5	4.7 - 3.3M	EIAJ-RC -2690	★ ★	3.2 ^{+0.10} _{-0.15}	1.6 ^{+0.1} _{-0.15}	0.45±0.25	0.4 ^{+0.2} _{-0.1}	0.5-0.65
CR 4	0.25			±10	2.2 - 10M							
				±20	1 - 20M							

Z CHIP JUMPER (ZERO OHM)

Type	Rated current	Resistance	Overload
Z 16	1A	< 50mΩ	5A 1sec
Z 21	1A	< 50mΩ	5A 1sec
Z 32	2A	< 50mΩ	10A 1sec

☆ Rated voltage: $\sqrt{P \cdot R}$ P=Rated power (W) R=Nominal resistance (Ω) This value should be less than the value listed above.
 ★★ M (20%) version can be supplied with 'no-trimming'.

Type designation

CR	8	101	J	T																			
Type	Power Rating	Resistance	Tolerance	Packing																			
	<table border="1"> <tr><td>16</td><td>0.063</td></tr> <tr><td>10</td><td>0.1</td></tr> <tr><td>6</td><td>0.167</td></tr> <tr><td>8</td><td>0.125</td></tr> <tr><td>4</td><td>0.25</td></tr> </table>	16	0.063	10	0.1	6	0.167	8	0.125	4	0.25	<table border="1"> <tr><td>E - 24</td></tr> <tr><td>E - 96</td></tr> </table>	E - 24	E - 96	<table border="1"> <tr><td>F = 1%</td></tr> <tr><td>G = 2%</td></tr> <tr><td>J = 5%</td></tr> <tr><td>K = 10%</td></tr> <tr><td>M = 20%</td></tr> </table>	F = 1%	G = 2%	J = 5%	K = 10%	M = 20%	<table border="1"> <tr><td>T</td><td>Face-up taping (This means regular taping being used now.)</td></tr> </table>	T	Face-up taping (This means regular taping being used now.)
16	0.063																						
10	0.1																						
6	0.167																						
8	0.125																						
4	0.25																						
E - 24																							
E - 96																							
F = 1%																							
G = 2%																							
J = 5%																							
K = 10%																							
M = 20%																							
T	Face-up taping (This means regular taping being used now.)																						

CHIP RESISTORS

Characteristic

Item	Specifications	Test method
Operating temp. range	- 55°C - 125°C	
T.C.R.	R < 10Ω : ±500ppm/°C 10Ω < R < 1MΩ : ±200ppm/°C R > 1MΩ : ±50ppm/°C	Room temperature + 100°C
Temperature cycling	less than ± (1% + 0.1Ω)	- 55°C - 125°C
Short time overload	± (1% + 0.1Ω)	Rated voltage X 2.5 for 5 seconds
Moisture storage	less than ± (3.0% + 0.1Ω)	40°C 90 - 95%RH
Moisture load life	less than ± (3.0% + 0.1Ω)	40°C 90 - 95%RH
Load life	less than ± (3% + 0.1Ω)	70°C for 1000 hours
Vibration	less than ± (1% + 0.1Ω)	Low frequency, 3 directions, 2 hours each
Solderability	to be covered more than 95%	230°C for 3 seconds
Resistance to soldering heat	± (2% + 0.1Ω)	260°C for 10 seconds
Terminal strength	less than ± (1% + 0.1Ω)	500g

Characteristic data

Load life 1000Hr

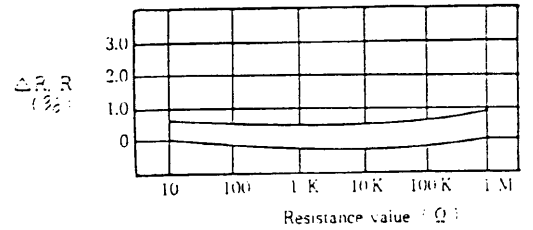

Moisture load life 1000Hr

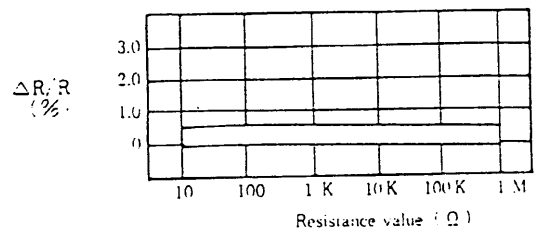

Short time overload

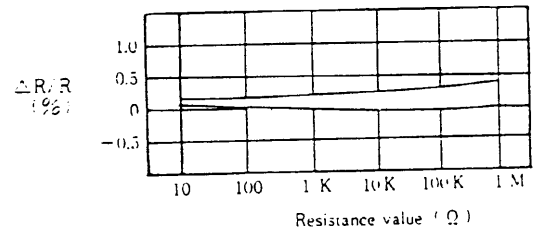

Packaging

● Taping

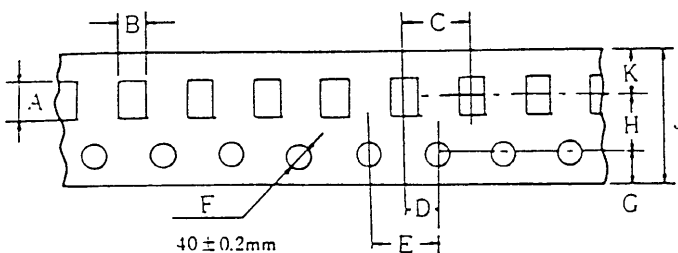

Accumulated dimensional tolerance 40 ± 0.2mm (mm)

Type	A	B	C	D	E	F	G	H	J	K
CR 16 Z 16	1.9 ±0.2	1.1 ±0.2	4.0 ±0.1	2.0 ±0.05	4.0 ±0.1	1.5 +0.1 -0	1.75 ±0.1	3.5 ±0.05	8.0 ±0.3	2.75
CR 10 CR 6 Z 21	2.4 ±0.2	1.65 ±0.2	4.0 ±0.1	2.0 ±0.05	4.0 ±0.1	1.5 +0.1 -0	1.75 ±0.1	3.5 ±0.05	8.0 ±0.3	2.75
CR 8 CR 4 Z 32	3.57 +0.1 -0.15	2.0 +0.1 -0.15	4.0 ±0.1	2.0 ±0.05	4.0 ±0.1	1.5 +0.1 -0	1.75 ±0.1	3.5 ±0.05	8.0 ±0.3	2.75

Tape Reel dimensions

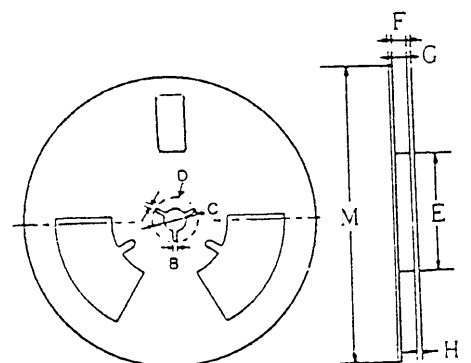

B	C	D	E	F	G	H	M
2.5 ±0.5	13.0 ±0.5	31.0 ±0.8	80.0 ±0.2	10.0 +1.0 -0.5	9.0 +1.0 -0.5	0.8 ±0.15	178 ±2

Our High Quality Thick Film Chip Resistors

GENERAL SPECIFICATION

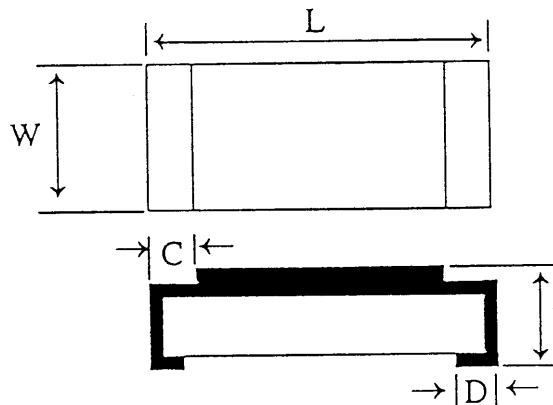

A. CHIP RESISTORS

DIMENSION IN MM

TYPE	WATTS	IMPERIAL SIZE	METRIC SIZE	L	W	C	D	t
CR 16	1/16	0603	1608	1.6 ± 0.2	0.8 ± 0.2	0.3 ± 0.2	0.3 ± 0.2	0.4 - 0.55
CR 10	1/10	0805	2125	$2.0^{+0.2}_{-0.1}$	$1.25^{+0.2}_{-0.1}$	0.4 ± 0.2	$0.3^{+0.2}_{-0.1}$	0.4 - 0.55
CR 6	1/6							
CR 8	1/8	1206	3216	$3.2^{+0.1}_{-0.15}$	$1.6^{+0.1}_{-0.15}$	0.45 ± 0.25	$0.4^{+0.2}_{-0.1}$	0.5 - 0.65
CR 4	1/4							

B. CHIP JUMPER (ZERO OHM)

- a. Z 16
(1.6 x 0.8mm)
- b. Z 21
(2.0 x 1.25mm)
- c. Z 32
(3.2 x 1.6mm)

C. CHIP JUMPER (LOW IMPEDANCE)

- a. CJ 16
(1.6 x 0.8mm)
- b. CJ 21
(2.0 x 1.25mm)
- c. CJ 32
(3.2 x 1.6mm)