

0.25mm Pitch, 0.5mm High, Top Contact, Back Flip Super Low Profile FPC Connector

FH64MA Series

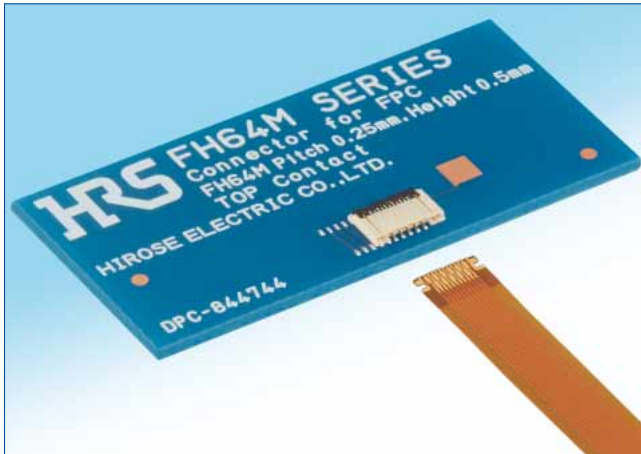

A thoroughly space-saving design with a super low profile, a narrow pitch and a narrow depth

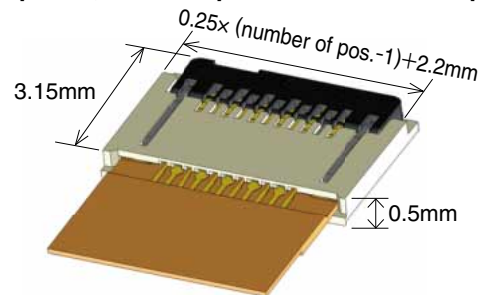

Fig.1

■ Features

1. Super low profile, top contact

This top contact connector has a very thin structure with an overall connector height of 0.5mm. (Fig.1)

2. Space-saving design

A thorough space-saving design on a 0.25mm pitch, 3.15mm depth (Locked status of actuator) produces a thorough space-saving function. (Fig.1)

3. Smooth FPC insertion

Mating guide on the connector allows for smooth FPC insertion in spite of the super low profile. (Fig.2)

Smooth FPC insertion

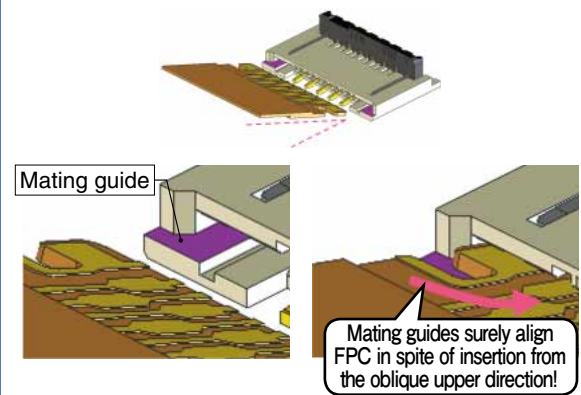

Fig.2

4. High FPC retention force

The notches on both sides of FPC are held by metal tabs, generating a high FPC retention force in spite of the small size. (Fig.3)

High FPC retention force

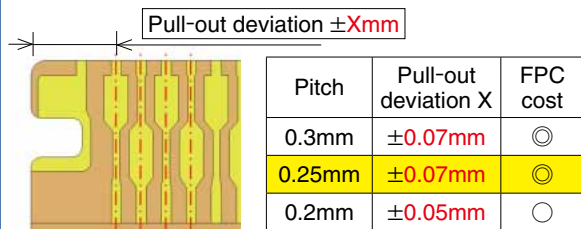

Fig.3

5. Easy-to-manufacture FPC in spite of the narrow pitch

In spite of the narrow pitch of $P=0.25\text{mm}$, similar pull-out deviation tolerance of $P=0.3\text{mm}$ creates the narrow pitch without increasing the cost. (Fig.4)

General tolerance of FPC



*The FPC cost is an example image.

Fig.4

6. Detects unmated FPC by means of the proprietary mechanism.

Correct FPC insertion can be checked with FPC pattern and mis-insertion can be detected. (Fig.5)

FPC mis-mating detected

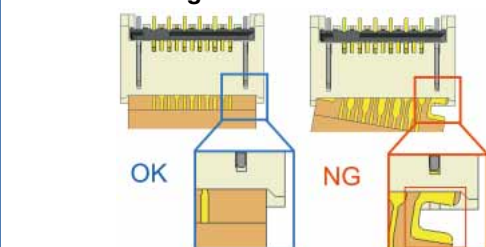

Fig.5

7. Halogen free

*AS defined by IEC 61249-2-21.

Br : 900ppm max, Cl : 900ppm max,
Br+Cl : 1,500ppm max

Product Specifications

Rating	Current rating	0.2A	Operating Temperature Range	-55 to +85°C (Note 1)	Storage Temperature Range	-10 to +50°C (Note 2)
	Voltage rating	AC/DC 30Vrms	Operating Humidity Range	Relative humidity 90% RH or less (no condensation)	Storage Humidity Range	Relative humidity 90% RH or less (no condensation)

Recommended FPC SPC	t=0.12±0.02 Gold plated
---------------------	-------------------------

Items	Specifications	Conditions
1. Insulation Resistance	50MΩ min	100V DC
2. Withstanding Voltage	No flashover or insulation breakdown	90Vrms AC/1min
3. Contact Resistance	200mΩ max *Including FPC conductor resistance	1mA AC
4. Mechanical Operation	Contact resistance : 200mΩ max No damages, cracks and looseness of parts	10 times insertions and extractions.
5. Vibration Resistance	Contact resistance : 200mΩ max No damages, cracks and looseness of parts	Frequency : 10 to 55Hz, half amplitude : 0.75mm, for 10 cycles in 3 axial directions.
6. Shock Resistance	No electrical discontinuity of 1μs or longer Contact resistance : 200mΩ max No damages, cracks and looseness of parts	Acceleration : 981m/s ² , duration 6ms, half-sine wave, at 3 times in 3 axial directions
7. Moisture Resistance in steady state	Contact resistance : 200mΩ max Insulation resistance : 50MΩ min No damages, cracks and looseness of parts	96 hours at 40°C and humidity of 90 to 95%
8. Temperature Cycles	Contact resistance : 200mΩ max Insulation resistance : 50MΩ min No damages, cracks and looseness of parts	Temperature : -55→+15 to +35→+85→+15 to +35°C Time : 30 → 2 to 3 → 30 → 2 to 3minutes 5 cycles with above conditions
9. Resistance to Soldering Heat	No deformation of case or excessive looseness of the terminals	Reflow : See recommended temperature profile (page 6) Manual soldering : 350±10°C, 5seconds

Note 1 : Including temperature rise caused by current flow.

Note 2 : The term "storage" refers to the long-term storage condition of unused products before PCB mounting.
For no-electrification state after PCB mounting, the operating temperature and humidity are applied.

Materials / Finish

Parts	Material	Finish/Color	UL Regulation
Insulator	LCP	Beige	UL94V-0
	PA	Black	
Contact	Phosphor bronze	Nickel barrier gold plated	—
Metal fitting	Phosphor bronze	Pure tin reflow plated	

Product Number Structure

Refer to the chart below when determining the product specifications from the product number.
Please select from the product numbers listed in this catalog when placing orders.

FH 64MA – 11S – 0.25 SHW (99)

① ② ③ ④ ⑤ ⑥

① Series Name : FH	⑤ Terminal Type SHW...SMT horizontal staggered mounting type
② Series No. : 64MA	
③ No. of Contacts : 11	
④ Contact Pitch : 0.25mm	
⑥ Specifications None : Regular(5000 pcs/reel) (99) : 500 pcs/reel	

Connector Dimensions

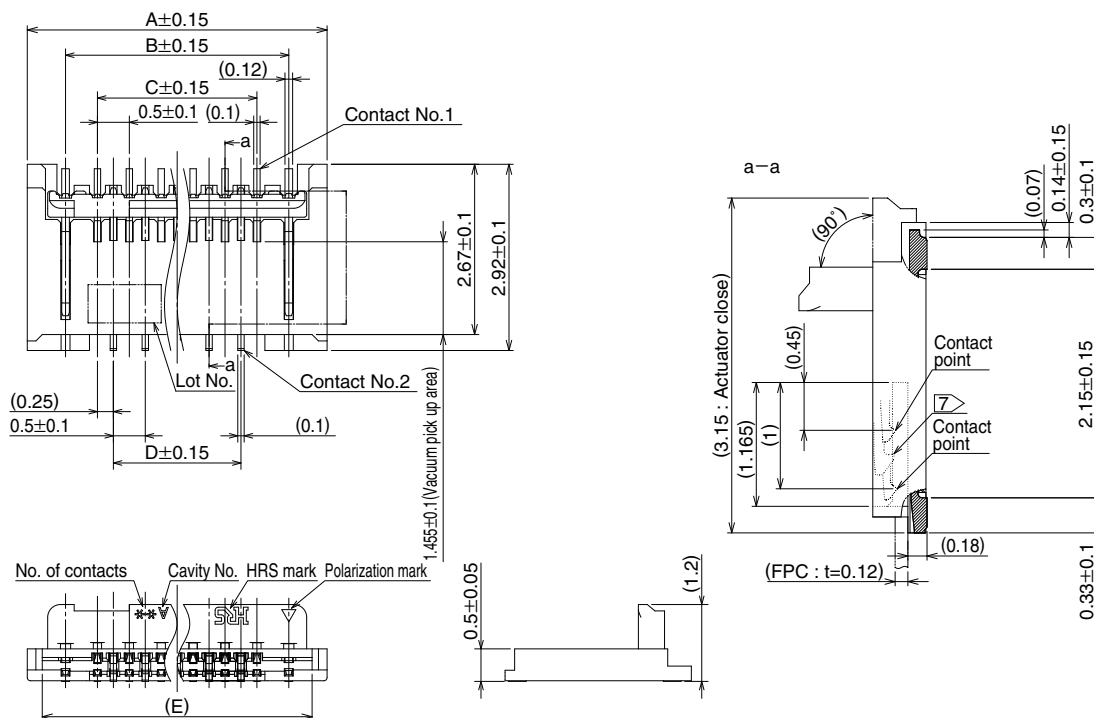

Note

- 1 : The dimension in parentheses are for reference.
- 2 : Lead co-planarity including reinforced chucking metals shall be 0.1 max.
- 3 : To be delivered with tape and reel packages.
See the packaging specifications for details.
- 4 : Note that preventive hole for sink mark or slit could be added for improvement.
- 5 : The quality remains good, even with the dark spots, which could occasionally occur on molded plastic.
- 6 : This product satisfies halogen free requirements defined as 900ppm maximum chlorine, 900ppm maximum bromine, and 1500ppm maximum total of chlorine and bromine.
- 7 Shows hook part of the chucking metal.

Units : mm

Part No.	HRS No.	No. of Contacts	A	B	C	D	E
FH64MA-7S-0.25SHW(**)	580-4610-0 **	7	3.7	2.5	1.5	1	3.23
FH64MA-9S-0.25SHW(**)	Under planning (Note 1)	9	4.2	3	2	1.5	3.73
FH64MA-11S-0.25SHW(**)	580-4612-0 **	11	4.7	3.5	2.5	2	4.23
FH64MA-13S-0.25SHW(**)	Under planning (Note 1)	13	5.2	4	3	2.5	4.73
FH64MA-15S-0.25SHW(**)	580-4608-0 **	15	5.7	4.5	3.5	3	5.23
FH64MA-17S-0.25SHW(**)	Under planning (Note 1)	17	6.2	5	4	3.5	5.73
FH64MA-19S-0.25SHW(**)	Under developing (Note 1)	19	6.7	5.5	4.5	4	6.23
FH64MA-21S-0.25SHW(**)	Under planning (Note 1)	21	7.2	6	5	4.5	6.73

Note 1 : Contact positions without HRS No. are currently under planning and developing.
Please contact hirose for detailed information about product variation.

◆ Recommended PCB Mounting Pattern

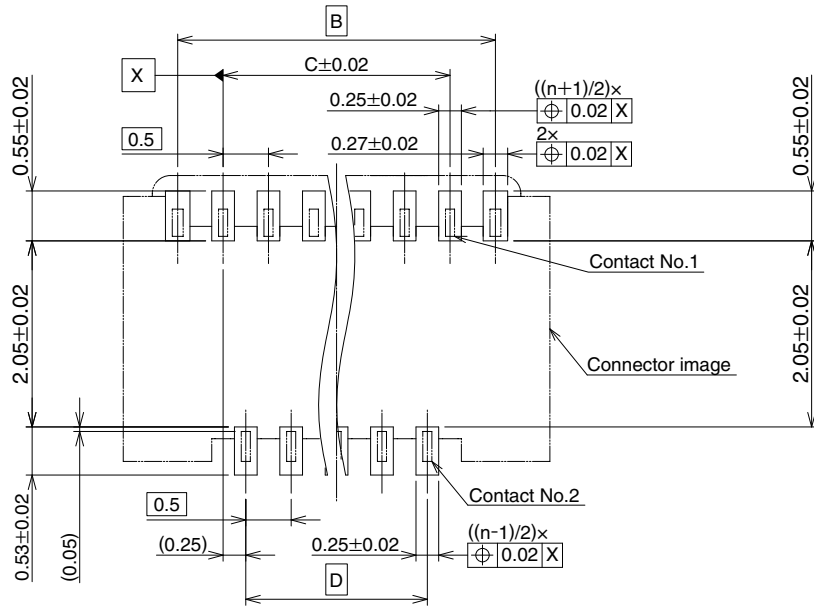

◆ Recommended Stencil Pattern

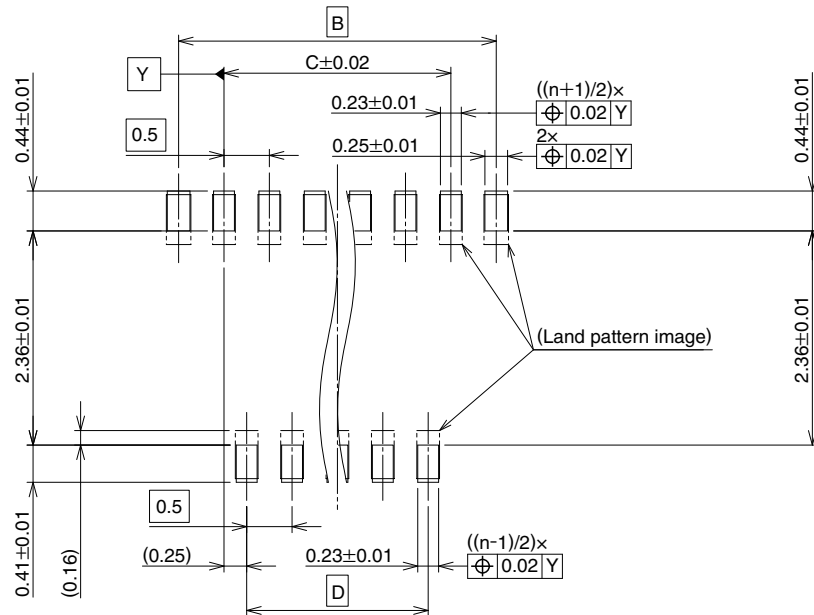

Note 8 : 'n' shows the number of contacts.

Units : mm

Part No.	HRS No.	No. of Contacts	B	C	D
FH64MA-7S-0.25SHW(**)	580-4610-0 **	7	2.5	1.5	1
FH64MA-9S-0.25SHW(**)	Under planning (Note 1)	9	3	2	1.5
FH64MA-11S-0.25SHW(**)	580-4612-0 **	11	3.5	2.5	2
FH64MA-13S-0.25SHW(**)	Under planning (Note 1)	13	4	3	2.5
FH64MA-15S-0.25SHW(**)	580-4608-0 **	15	4.5	3.5	3
FH64MA-17S-0.25SHW(**)	Under planning (Note 1)	17	5	4	3.5
FH64MA-19S-0.25SHW(**)	Under developing (Note 1)	19	5.5	4.5	4
FH64MA-21S-0.25SHW(**)	Under planning (Note 1)	21	6	5	4.5

Note 1 : Contact positions without HRS No. are currently under planning and developing. Please contact Hirose for detailed information about product variation.

◆ Recommended FPC Dimensions

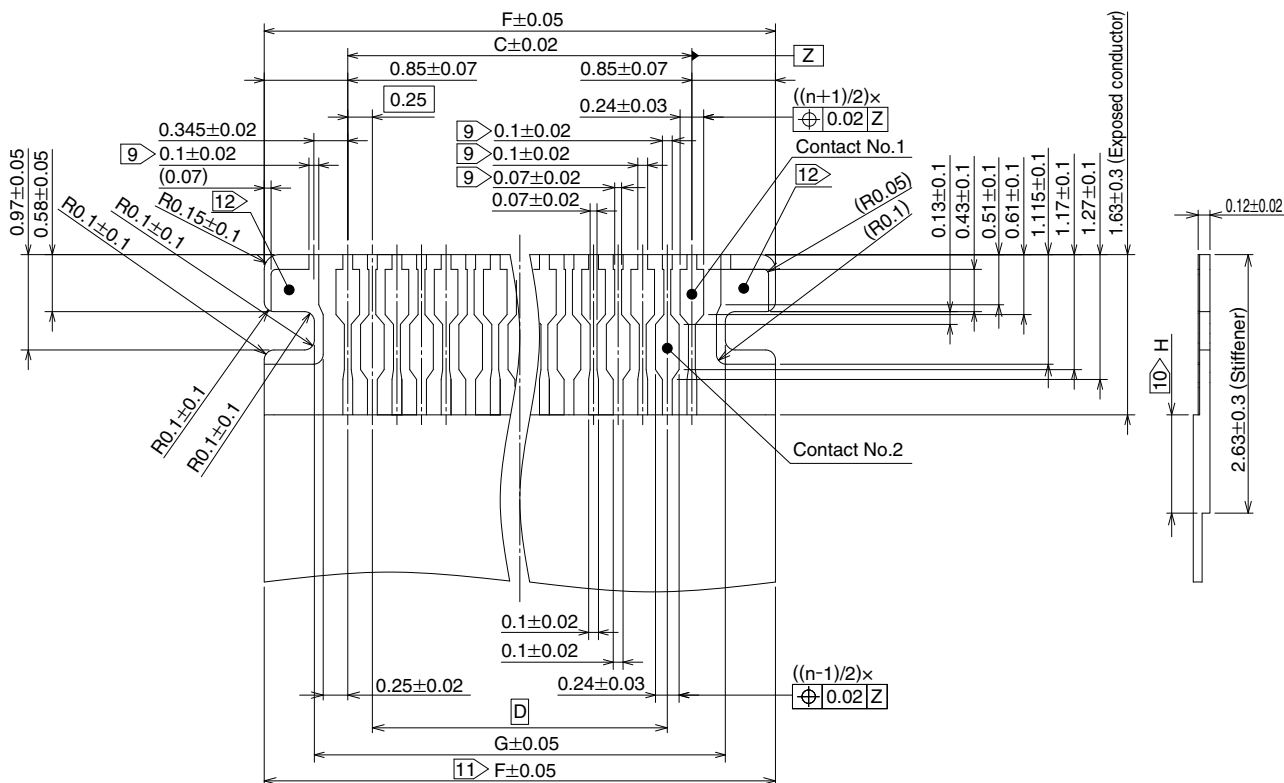

Note

- 9 Shows recommended dimensions when lead for plating is required.
- 10 Dimension H must be 0.5mm minimum.
- 11 Indicated tolerance is applicable to the exposed conductor.
- 12 Both end sides of contact pad on FPC cannot be used for signal transmission.

Units : mm

Part No.	HRS No.	No. of Contacts	C	D	F	G
FH64MA-7S-0.25SHW(**)	580-4610-0 **	7	1.5	1	3.2	2.18
FH64MA-9S-0.25SHW(**)	Under planning (Note 1)	9	2	1.5	3.7	2.68
FH64MA-11S-0.25SHW(**)	580-4612-0 **	11	2.5	2	4.2	3.18
FH64MA-13S-0.25SHW(**)	Under planning (Note 1)	13	3	2.5	4.7	3.68
FH64MA-15S-0.25SHW(**)	580-4608-0 **	15	3.5	3	5.2	4.18
FH64MA-17S-0.25SHW(**)	Under planning (Note 1)	17	4	3.5	5.7	4.68
FH64MA-19S-0.25SHW(**)	Under developing (Note 1)	19	4.5	4	6.2	5.18
FH64MA-21S-0.25SHW(**)	Under planning (Note 1)	21	5	4.5	6.7	5.68

Note 1 : Contact positions without HRS No. are currently under planning and developing.
Please contact hirose for detailed information about product variation.

◆ FPC Configuration (Reference example)

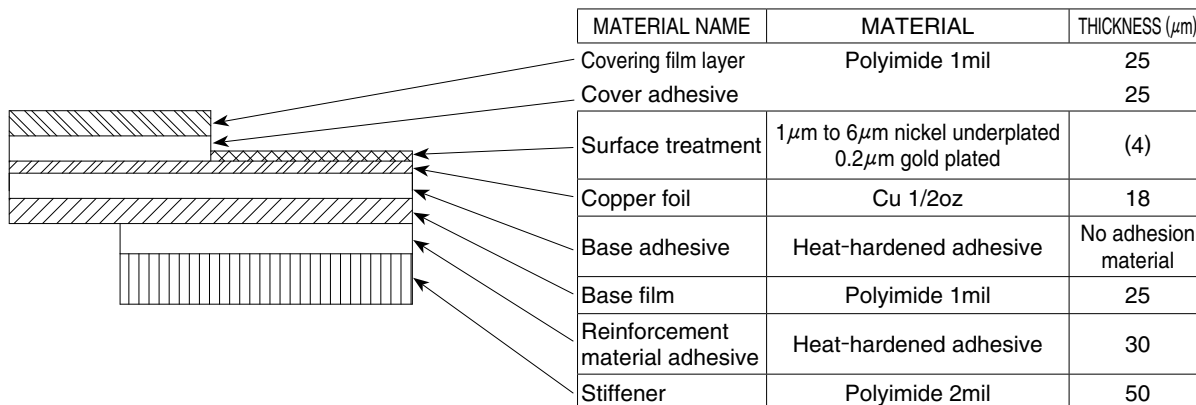

◆ Packaging Specifications

● Embossed Carrier Tape Dimensions

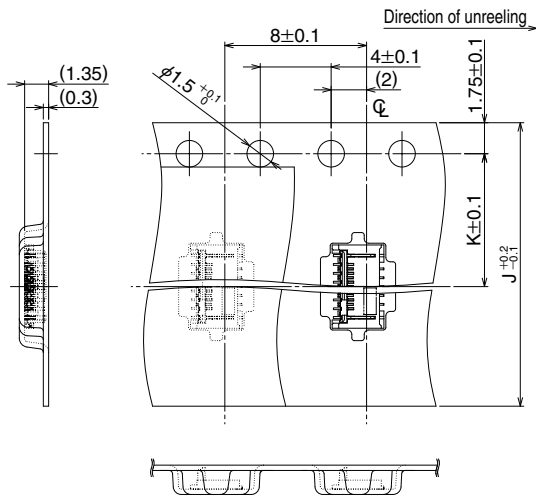

● Reel Dimensions

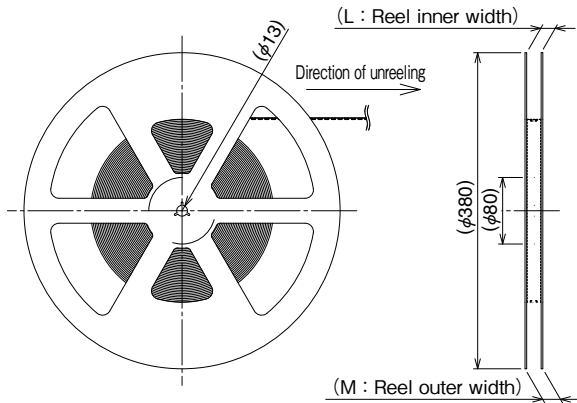

● Leader, Trailer Dimensions

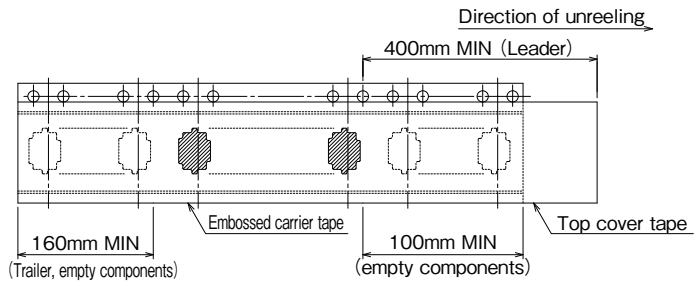

Units : mm

Part No.	HRS No.	No. of Contacts	J	K	L	M
FH64MA-7S-0.25SHW(**)	580-4610-0 **	7	16	7.5	17.4	21.4
FH64MA-9S-0.25SHW(**)	Under planning (Note 1)	9	16	7.5	17.4	21.4
FH64MA-11S-0.25SHW(**)	580-4612-0 **	11	16	7.5	17.4	21.4
FH64MA-13S-0.25SHW(**)	Under planning (Note 1)	13	16	7.5	17.4	21.4
FH64MA-15S-0.25SHW(**)	580-4608-0 **	15	16	7.5	17.4	21.4
FH64MA-17S-0.25SHW(**)	Under planning (Note 1)	17	16	7.5	17.4	21.4
FH64MA-19S-0.25SHW(**)	Under developing (Note 1)	19	16	7.5	17.4	21.4
FH64MA-21S-0.25SHW(**)	Under planning (Note 1)	21	24	11.5	25.4	29.4

Note 1 : Contact positions without HRS No. are currently under planning and developing.
Please contact hirose for detailed information about product variation.

◆ Temperature Profile

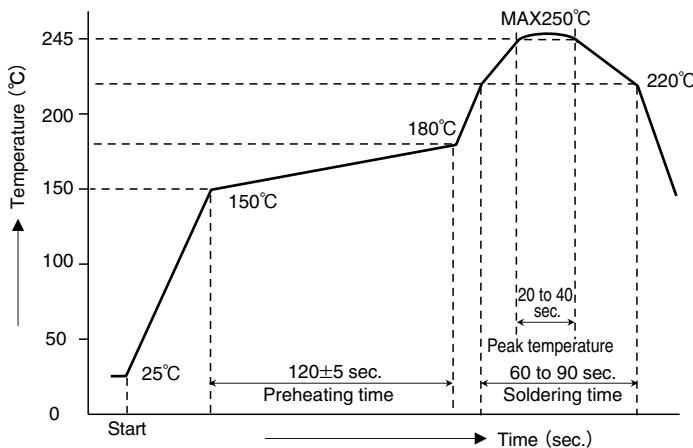

Applicable Conditions

- Reflow method : IR/Hot air
- Reflow environment : Room air
- Solder : Paste type Sn/3.0Ag/0.5Cu (M705-GRN360-K2-V made by Senju Metal Industry Co.)
- Test PCB : PCB material and size Glass epoxy 32.85×15.7×1mm Land size, per recommended on page 4.
- Metal mask : Thickness and opening size Per recommended on page 4.

This temperature profile is based on the above conditions. It may vastly depending on solder paste type, manufacturer, PCB size and mounting materials. Please use only after checking the mounting conditions.

◆ Operation Methods of Connectors and Precautions

[Operation method]

As this connector is a small-sized, thin product, care needs to be taken when handling. Check the following before use.

1. Initially delivered state

The actuator is delivered in the open state, It does not need to operated before inserting FPC.

[Caution]

- Do not close the actuator while FPC is not inserted. If the actuator is closed without the FPC inserted, the FPC insertion force could increase due to the narrower contact gap.
- Do not operate the connector while it is not mounted on the board.

2. How to insert FPC

Insert FPC to the end placed horizontal to the board surface. (Example 1)

[Caution]

- Do not insert FPC while the actuator is closed. (Example 2)
- When FPC is inserted, do not move it in vertical, lateral or diagonal directions.

(Example 1)

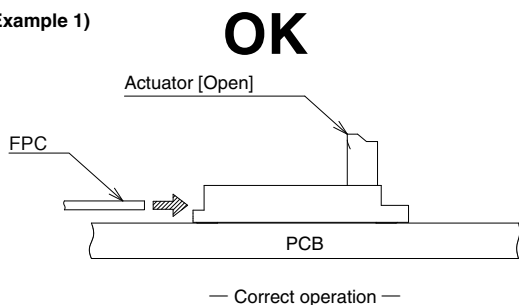

(Example 2)

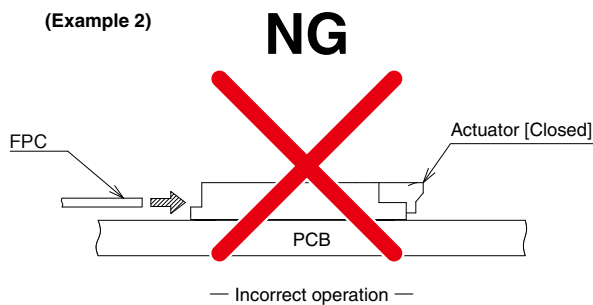

3. Check the inserted state of FPC

When FPC is completely inserted, visually inspect the inserted status of FPC. (Example 3)

[Caution]

- FPC is not inserted deep enough or in a diagonal direction. (Example 4)(Example 5)

(Example 3)

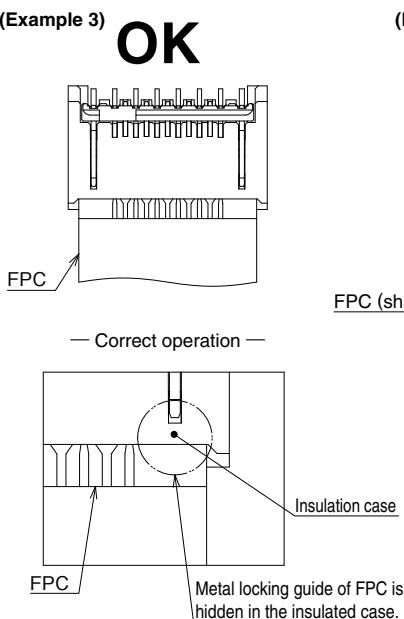

(Example 4)

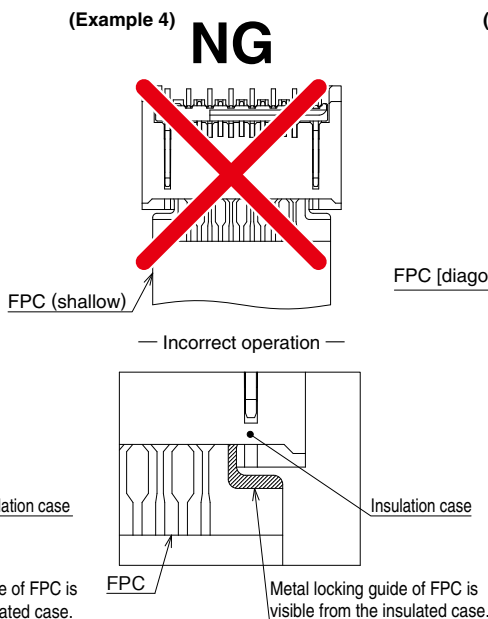

(Example 5)

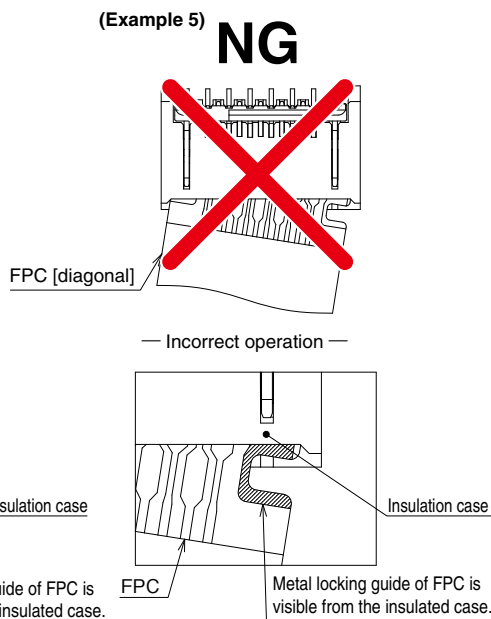

◆ Operation Methods of Connectors and Precautions

[Operation method]

4. Actuator locking mechanism

Actuator rotates around the actuator rotation axis.
After inserting FPC, operate the actuator rotating 90°.

[Caution]

- Operate the actuator around the center when locked. (Example 6)
- Do not operate the actuator on one side only when locked. (Example 7)
- Do not operate the actuator by pushing in the vertical direction. (Example 8)
- Do not apply excessive force to the housing during operation. (Example 9)

(Example 6)

Operate the actuator around the center.

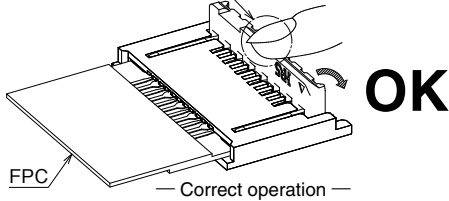

(Example 7)

Operate the actuator on one side.

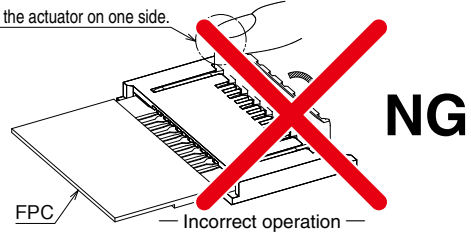

(Example 8)

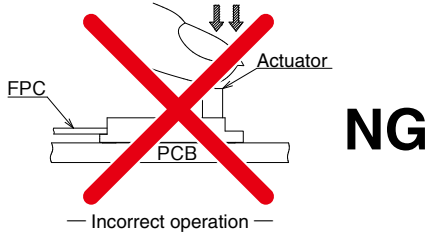

(Example 9)

Apply an excessive force to the housing.

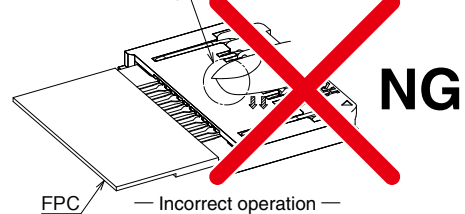

5. How to unlock the actuator

Push the actuator up slowly and release the lock. (Example 10)

[Caution]

- Operate the actuator around the center when unlocked. (Example 11)
- Do not operate the actuator on one side only when unlocked. (Example 12)
- The actuator cannot be opened to over 90°, Do not open it over this angle. (Example 13)
- This connector adopts a back-flip design, and there is difference between the FPC insertion direction and the direction of the actuator. Do not try to open FPC from its insertion side. (Example 14)

(Example 10)

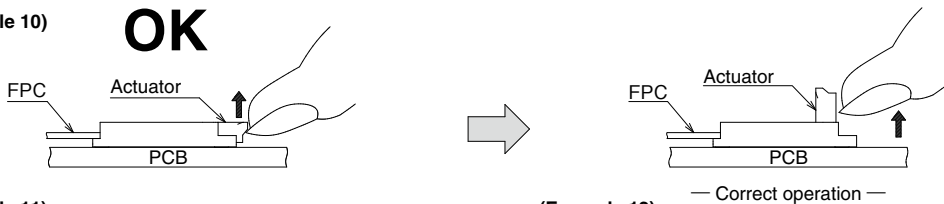

(Example 11)

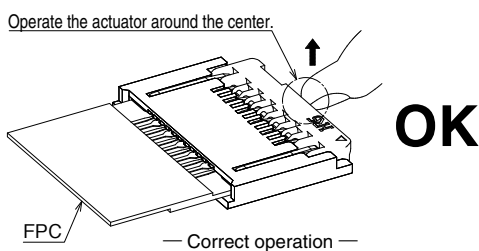

(Example 12)

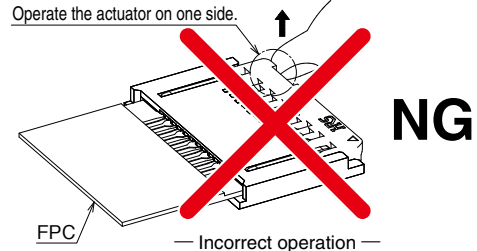

(Example 13)

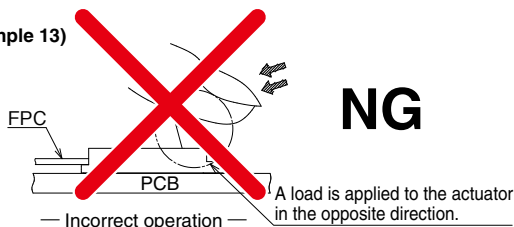

(Example 14)

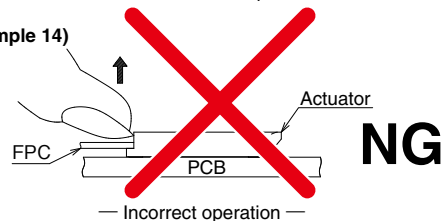

◆ Operation Methods of Connectors and Precautions

[Operation method]

6. How to remove FPC

After releasing the actuator lock, remove the FPC in the horizontal direction. (Example 15)

[Caution]

- When pulling out FPC, don't apply load in the upward or lateral direction. (Example 16)
- Don't pull out FPC while the actuator is locked. (Example 17)

(Example 15)

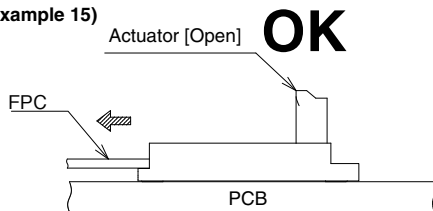

— Correct operation —

(Example 16)

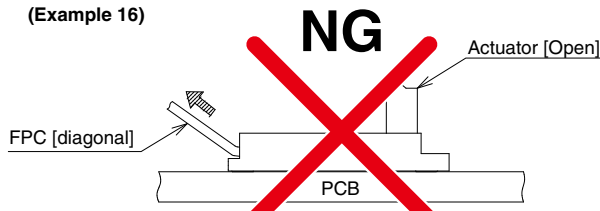

— Incorrect operation —

(Example 17)

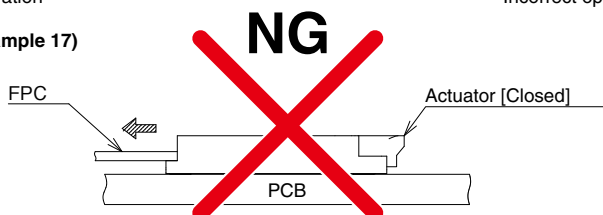

— Incorrect operation —

7. Routing of FPC

Depending on the routing of FPC to mate, a load may be applied to the connector, which could lead to a failure. In order to prevent failure, please consider the following concerning the mechanism design.

[Caution]

- When routing FPC, please be careful that FPC is not pulled and routing is carried out with a margin.
- Please check that the stiffener is placed horizontal to the board surface. (Example 18)
- Please insure there is no load is applied to the connector in the pulling, inserting or lateral direction. (Example 19)(Example 20)
- When routing the FPC, carry out the routing operation in a manner that no direct load is applied to the connector. Please take some caution such as to fix FPC etc. (Example 19)
- Don't place any parts under the FPC that will interfere with FPC. (Example 21)

(Example 18)

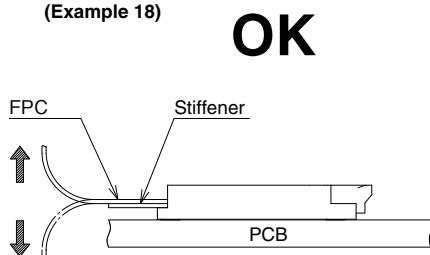

(Example 19)

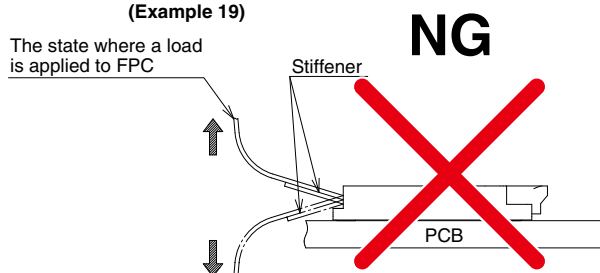

(Example 20)

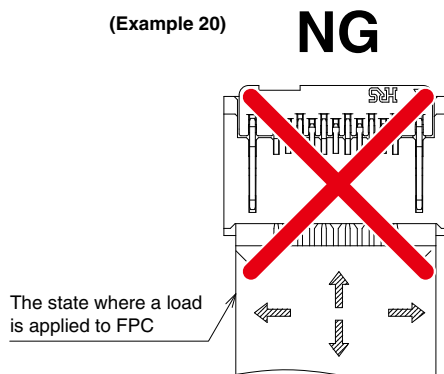

(Example 21)

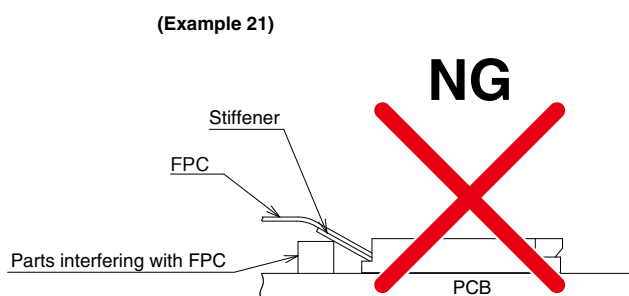

[Cautions when Mounting PCB]

◆ **Warp of PCB**

Minimize warp of the PCB as much as possible.
 Lead co-planarity including reinforced metals is 0.1mm or less.
 Too much warp of the PCB may result in a soldering failure.

◆ **Flexible board design**

Please make sure to put a stiffener on the backside of the flexible board.
 We recommend a glass epoxy material with the thickness of 0.3mm MIN.

◆ **Load to Connector**

Do not add 0.5N or greater external force when unreel or pick and place the connector etc,
 or it may get broken.
 In addition, do not insert the FPC or operate the connector before mounting.

◆ **Load to PCB**

- Splitting a large PCB into several pieces
 - Screwing the PCB
- Avoid the handling described above so that no force is exerted on the PCB during the assembly process.
 Otherwise, the connector may become defective.

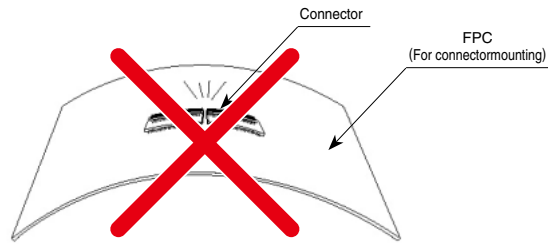

◆ **Instructions on manual soldering**

Follow the instructions shown below when soldering the connector manually during work, etc.

- ① Do not perform manual soldering with the FPC inserted into the connector.
 - ② Do not heat the connector excessively. Be very careful not to let the soldering iron contact any parts other than connector leads. Otherwise, the connector may be deformed or melt.
 - ③ Do not supply excessive solder (or flux).
- If excessive solder (or flux) is supplied on the terminals, solder or flux may adhere to the contacts or rotating parts of the actuator, resulting in poor contact or a rotation failure of the actuator.
 Supplying excessive solder to the chucking metals may hinder actuator rotation, resulting in breakage of the connector.

MEMO :

Area with horizontal dashed lines for writing.

USA:

HIROSE ELECTRIC (U.S.A.), INC. HEADQUARTERS CHICAGO OFFICE
2300 Warrenville Road, Suite 150,
Downers Grove, IL 60515
Phone : +1-630-282-6700
<http://www.hirose.com/us/>

USA:

HIROSE ELECTRIC (U.S.A.), INC. SAN JOSE OFFICE
2841 Junction Ave, Suite 200
San Jose, CA. 95134
Phone : +1-408-253-9640
Fax : +1-408-253-9641
<http://www.hirose.com/us/>

USA:

HIROSE ELECTRIC (U.S.A.), INC. DETROIT OFFICE (AUTOMOTIVE)
17197 N. Laurel Park Drive, Suite 253,
Livonia, MI 48152
Phone : +1-734-542-9963
Fax : +1-734-542-9964
<http://www.hirose.com/us/>

USA:

HIROSE ELECTRIC (U.S.A.), INC. BOSTON OFFICE
300 Brickstone Square Suite 201,
Andover, MA 01810
Phone : +1-978-662-5255

THE NETHERLANDS:

HIROSE ELECTRIC EUROPE B.V.
Hogehillweg #8 1101 CC Amsterdam Z-0
Phone : +31-20-6557460
Fax : +31-20-6557469
<http://www.hirose.com/eu/>

GERMANY:

HIROSE ELECTRIC EUROPE B.V. GERMAN BRANCH
Schoenbergstr. 20, 73760 ostfildern
Phone : +49-711-456002-1
Fax : +49-711-456002-299
<http://www.hirose.com/eu/>

GERMANY:

HIROSE ELECTRIC EUROPE B.V. NUREMBERG OFFICE
Neumeyerstrasse 22-26, 90411 Nurnberg
Phone : +49-911 32 68 89 63
Fax : +49-911 32 68 89 69
<http://www.hirose.com/eu/>

GERMANY:

HIROSE ELECTRIC EUROPE B.V. HANOVER OFFICE
Bayernstr. 3, Haus C 30855 Langenhagen, Germany
Phone : +49-511 97 82 61 30
Fax : +49-511 97 82 61 35
<http://www.hirose.com/eu/>

FRANCE:

HIROSE ELECTRIC EUROPE B.V. PARIS OFFICE
130 Avenue Joseph Kessel, Bat E, 78960
Voisins le Bretonneux, France
Phone : +33-1-85764886
Fax : +33-1-85764823
<http://www.hirose.com/eu/>

UNITED KINGDOM:

HIROSE ELECTRIC EUROPE BV (UK BRANCH)
4 Newton Court, Kelvin Drive, Knowlhill,
Milton Keynes, MK5 8NH
Phone : +44-1908 202050
Fax : +44-1908 202058
<http://www.hirose.com/eu/>

CHINA:

HIROSE ELECTRIC (SHANGHAI) CO., LTD.
18, Enterprise Center Tower 2, 209# Gong He
Road, Jing'an District, Shanghai, CHINA 200070
Phone : +86-21-6391-3355
Fax : +86-21-6391-3335
<http://www.hirose.com/cn/>

CHINA:

HIROSE ELECTRIC (SHANGHAI) CO.,LTD. BEIJING BRANCH
A1001, Ocean International Center, Building 56# East 4th
Ring Middle Road, ChaoYang District, Beijing, 100025
Phone : +86-10-5165-9332
Fax : +86-10-5908-1381
<http://www.hirose.com/cn/>

CHINA:

HIROSE ELECTRIC TECHNOLOGIES (SHENZHEN) CO., LTD.
Room 09-13, 19/F, Office Tower Shun Hing Square, Di Wang Commercial Centre,
5002 Shen Nan Dong Road, Shenzhen City, Guangdong Province, 518008
Phone : +86-755-8207-0851
Fax : +86-755-8207-0873
<http://www.hirose.com/cn/>

HONG KONG:

HIROSE ELECTRIC HONGKONG TRADING CO., LTD.
Room 1001, West Wing, Tsim Sha Tsui Centre, 66
Mody Road, Tsim Sha Tsui East, Kowloon, Hong Kong
Phone : +852-2803-5338
Fax : +852-2591-6560
<http://www.hirose.com/hk/>

TAIWAN:

HIROSE ELECTRIC TAIWAN CO., LTD.
103 8F, No.87, Zhengzhou Rd., Taipei
Phone : +886-2-2555-7377
Fax : +886-2-2555-7350
<http://www.hirose.com/tw/>

KOREA:

HIROSE KOREA CO.,LTD.
143, Gongdan 1-daero, Siheung-si,
Gyeonggi-do, 15084, Korea
Phone : +82-31-496-7000
Fax : +82-31-496-7100
<http://www.hirose.co.kr/>

SINGAPORE:

HIROSE ELECTRIC SINGAPORE PTE. LTD.
03, Anson Road, #20-01, Springleaf Tower,
Singapore 079909
Phone : +65-6324-6113
Fax : +65-6324-6123
<http://www.hirose.com/sg/>

INDIA:

HIROSE ELECTRIC SINGAPORE PTE. LTD. DELHI LIAISON OFFICE
Office NO.552, Regus-Green Boulevard, Level5, Tower C,
Sec62, Plot B-9A, Block B, Noida, 201301, Uttar Pradesh, India
Phone : +91-12-660-8018
Fax : +91-120-4804949
<http://www.hirose.com/sg/>

INDIA:

HIROSE ELECTRIC SINGAPORE PTE. LTD. BANGALORE LIAISON OFFICE
Unit No-403, 4th Floor, No-84, Barton Centre, Mahatma
Gandhi (MG) Road, Bangalore 560 001, Karnataka, India
Phone : +91-80-4120 1907
Fax : +91-80-4120 9908
<http://www.hirose.com/sg/>

MALAYSIA:

PENANG REPRESENTATIVE OFFICE
73-3-1, Ideal@The One, Jalan Mahsuri, Bayan
Lepas Penang, 11950, Malaysia
Phone : +604-648-5536
<http://www.hirose.com/sg/>

THAILAND:

BANGKOK OFFICE (REPRESENTATIVE OFFICE)
Unit 4703, 47th FL., 1 Empire Tower, South Sathorn
Road, Yannawa, Sathorn, Bangkok 10120 Thailand
Phone : +66-2-686-1255
Fax : +66-2-686-3433
<http://www.hirose.com/sg/>



HIROSE ELECTRIC CO.,LTD.

2-6-3,Nakagawa Chuoh,Tsuzuki-Ku,Yokohama-Shi 224-8540,JAPAN
TEL: +81-45-620-3526 Fax: +81-45-591-3726
<http://www.hirose.com>
<http://www.hirose-connectors.com>