

**Software Embedded WLAN Module
IEEE802.11b/g/n**

WYSACVLAY-WX

Data Report

By purchase of any of products described in this document, the customer is deemed to understand and accept contents of this document.

WYSACVLAY-WX

TAIYO YUDEN CO., LTD.

ATTENTION: Software related to this module may be under Japan export control. Depending on the customer's country and application (e.g. weapons), Taiyo Yuden may not be able to provide the software to all customers. Please contact your local Taiyo Yuden sales office for additional information.

To contact your local sales office and for additional product information, please visit www.ty-top.com.

WYSACVLAY-WX

TAIYO YUDEN CO., LTD.

Document constituent list

Control name	Control No.	Document Page
General Items	HD-AG-A191017	1/8 - 8/8
Absolute maximum ratings	HD-AM-A191017	1/1
Electrical characteristics	HD-AE-A191017	1/4 – 4/4
Circuit schematic	HD-MC-A191017	1/2 – 2/2
Outline / Appearance	HD-AD-A191017	1/5 - 5/5
Pin Layout	HD-BA-A191017	1/2 - 2/2
Handling Precaution	HQ-BA-537	1/3 - 3/3
Packaging Specification	HD-BB-A191017	1/2 – 2/2
Antenna Application Note	-	1/3 - 3/3
Precautions	HQ-BK-002_02	1/2 – 2/2
Software Specification	-	1/68 – 68/68

Rev. record

17-Mar. 2020> Ver.1.0 Release

WYSACVLAY-WX

TAIYO YUDEN CO., LTD.

Control No. HD-AG-A191017 (1/8)	Control name General Items
---------------------------------------	-------------------------------

1. Scope

This specification ("Specification") applies to the hybrid IC "WYSACVLAY-WX" for use Wireless LAN module ("Product") manufactured by TAIYO YUDEN CO., LTD. ("TAIYO YUDEN")

2. Description

- ① Product Name : WYSACVLAY-WX
Type : WYSACVLAY

Note: Please let us know the Product Name (WYSACVLAY-WX) to order this product.

- ② Chip : NXP 88MW320

- ③ Function : CPU embedded Radio frequency transceiver Module.
(IEEE 802.11 b/g/n conformity)

TAIYO YUDEN standard application software embedded.

- ④ Application : IoT devices

- ⑤ Structure : Hybrid IC loaded with silicon monolithic semiconductor.

Regarding the containment of hazardous substance in this Product, it conforms to RoHS Directive.

Ability of lead free mounting at customer's assembly
(Heat resistance of this Product) : Yes

- ⑥ Outline : 44-pin Land Grid Array

- ⑦ Marking : Part Number, Lot Number, Japan ID, FCC ID, ISED ID and manufacturer on Shielding Case

- ⑧ Country of origin : Japan or Thailand

- ⑨ Packaging : Packaging method: Tray
Packaging unit: 840pcs
Standard order quantity : 840pcs multiples

- ⑩ Notes :

a. Limitation of Warranty

- i) TAIYO YUDEN provide warranties only if the product is operated under the condition set forth in this specification. Please note that TAIYO YUDEN shall not be liable for any defect and/or malfunction arising from use of the product under the terms and conditions other than the operating conditions hereof. In addition when this product is used under environmental conditions such as over voltage which is not guaranteed, it may be destroyed in short mode. To ensure the security of customer's product, please add an extra fuse or/and a protection circuit for over voltage.

TAIYO YUDEN CO., LTD.

WYSACVLAY-WX

TAIYO YUDEN CO., LTD.

Control No. HD-AG-A191017	(2/8)	Control name General Items
------------------------------	-------	-------------------------------

ii) In some cases, TAIYO YUDEN may use replacements as component parts of products. Such replacement shall apply only to component part of products, which TAIYO YUDEN deems it possible to replace or substitute according to (i) scope of warranty provided in this specification (e.g. electric characteristics, outline, dimension, conditions of use, reliability tests, official standard (type approvals etc.)) and (ii) quality of products. TAIYO YUDEN also ensures traceability of such replacement on production lot basis.

b. Instruction for Use (CAUTION)

i) This Product is not designed to be radiation-resistant. Please do not expose Product to radiation.

ii) Communication between this product and other might not be established nor maintained depending upon radio environment or operating condition of this product and other products with wireless technology.

iii) This product operates in the unlicensed ISM band at 2.4GHz. In case this product is used around the other wireless devices which operate in same frequency band of this product, there is a possibility that interference occurs between this product and such other devices. If such interference occurs, please stop the operation of other devices or relocate this product before using this product or do not use this product around the other wireless devices.

c. Term of Support

i) In the case that customer requests TAIYO YUDEN to customize the hardware of this Product in order to meet such customer's specific needs, TAIYO YUDEN will make commercially reasonable effort to modify such hardware or software at customer's expense; provide however, the customer is kindly requested to agree it doesn't mean that TAIYO YUDEN has obligations to do so even in the case it is technically difficult for TAIYO YUDEN.

ii) Any failure arising out of this Product will be examined by TAIYO YUDEN regardless of before or after mass production. Customer agrees that once such failure is turned out not to be responsible for TAIYO YUDEN after aforesaid examination, some of the technical support shall be conducted by TAIYO YUDEN at customer's expense; provided however, exact cost of this technical support can be agreed through the negotiation by the parties.

iii) Do not alter hardware and/or software of this Product. Please note that TAIYO YUDEN shall not be liable for any problem if it is caused by customer's alteration of Hardware without Taiyo Yuden's prior approvals.

WYSACVLAY-WX

TAIYO YUDEN CO., LTD.

Control No. HD-AG-A191017	(3/8)	Control name General Items
------------------------------	-------	-------------------------------

iv) TAIYO YUDEN does not guarantee functions and performances which depend on the customer's firmware. TAIYO YUDEN does not assume liabilities for defects and failures (i) in functions, performances and quality of the Customer's product incorporating the Products and (ii) which may occur as the Product is incorporated in the Customer's product.

d. Term of Warranty

TAIYO YUDEN warrants only that this Product is in conformity with this Specification for one year after purchase and shall in no event give any other warranty.

e. Items of the Specification

i) Any question arising from the Specification shall be solved in good faith through mutual discussion by the parties hereof.

ii) The language of this "General items" is Japanese and this "General items" shall be interpreted by Japanese Any copies of translation is a reference purpose only and is not binding on both parties hereto.

f. The use of Embedded Software and customer support

Please kindly read carefully and understand the following before using the Products.

i) TAIYO YUDEN Co., Ltd. (hereinafter "TAIYO YUDEN"), lawfully has copyrights and other rights to the software embedded to the memory of the Products (the "Embedded Software"). Except as otherwise expressly provided herein, your company is not permitted to disclose or offer the Embedded Software, either wholly or partly, to any third party (including uploading to your company or third party (ies)'s web sites and downloading by third parties from such sites), nor to copy, revise, reverse engineer, upgrade, make specification change, or alienate the Embedded Software.

ii) Before using the Products, your company need to check and confirm sufficient safety and operation of your company's products which incorporate the Products and interoperability and compatibility with other Wireless LAN enabled products. By execution or approval of this Specification, your company shall be deemed to have fully evaluated and confirmed the Products (including the Embedded Software) (the Embedded Software that your company has so fully evaluated and confirmed is hereinafter referred to as "Approved Software").

iii) Although TAIYO YUDEN has made full assessment of the Embedded Software, there is still possibility of malfunction of quality or performance due to the bug or other causes existing in or arising out of the Embedded Software, or due to combination with other product including your product. ("Potential Failure"). Your company shall be deemed to have agreed with the following by the execution or approval of this Specification.

TAIYO YUDEN CO., LTD.

WYSACVLAY-WX

TAIYO YUDEN CO., LTD.

Control No. HD-AG-A191017	(4/8)	Control name General Items
------------------------------	-------	-------------------------------

1) The Potential Failure shall not be deemed as defect or failure of the Embedded Software or the Products, under the agreement between TAIYO YUDEN and your company (executed either in past, or in the future) or under all applicable laws.

2) Your company shall indemnify, hold harmless and defend TAIYO YUDEN from and against any claims, lawsuits, or damages that arise or result from the Potential Failure.

iv) TAIYO YUDEN have not evaluated and confirmed the interoperability, compatibility, etc. of the Products (including Embedded Software) with every kind of Wireless LAN enabled product. In addition, TAIYO YUDEN does not guarantee interoperability and compatibility of the Product with certain devices. In order to minimize the damage or harm arising out of the Potential Failure or out of combination with other devices, TAIYO YUDEN recommend your company set up interface or external pin (for detail, please refer to Specification “ Pin Layout ” of this document) for rewriting the Embedded Software.

v) TAIYO YUDEN in principal will not accept your company request to update or change the specifications of the Approved Software.

⑪ Japan Regulatory Information

This module is approved with the specific antenna on this module. Please ensure that your product can also bear a label with the following information. If the product is so small that it is not practicable to place the label, you can also place it in the instruction manual and package. The mark diameter shall be easily legible without using a device such as light microscopes.

It is recommended to include the following sentence in the user manual of your product:
This product installs a radio system which has been approved as a radio station in a low power data communication system based on the Radio Law.
WYSACVLAY : 001-A15398

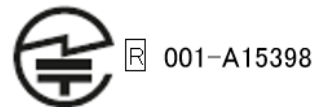

Region is set to US as default and 12ch(2467MHz) and 13ch(2472MHz) are disabled. Please change the region setting to Japan, if it is needed to use these channels on the final product.

⑫ Canada Regulatory Information

a) This device contains license-exempt transmitter(s)/receiver(s) that comply with Innovation, Science and Economic Development Canada's license-exempt RSS(s). Operation is subject to the following two conditions:

- (1) This device may not cause interference.
- (2) This device must accept any interference, including interference that may cause undesired operation of the device.

WYSACVLAY-WX

TAIYO YUDEN CO., LTD.

Control No. HD-AG-A191017	(5/8)	Control name General Items
------------------------------	-------	-------------------------------

Le présent appareil est conforme aux CNR Innovation, Sciences et Développement économique

Canada applicables aux appareils radio exempts de licence. L'exploitation est autorisée aux deux conditions suivantes:

- 1) l'appareil ne doit pas produire de brouillage;
- 2) l'utilisateur de l'appareil doit accepter tout brouillage radioélectrique subi, même si le brouillage est susceptible d'en compromettre le fonctionnement.

b) This equipment complies with ISED radiation exposure limits set forth for an uncontrolled environment and meets RSS-102 of the ISED radio frequency (RF) Exposure rules. This equipment should be installed and operated keeping the radiator at least 20cm or more away from person's body.

Cet équipement est conforme aux limites d'exposition aux rayonnements énoncées pour un environnement non contrôlé et respecte les règles d'exposition aux fréquences radioélectriques (RF) CNR-102 de l'ISED. Cet équipement doit être installé et utilisé en gardant une distance de 20 cm ou plus entre le radiateur et le corps humain.

c) Please notify certified ID by either one of the following method on your product.

Spécifiez ID certifiée dans votre produit par une de méthode suivante.

- Contains Transmitter module IC : 4389B-WYSACVLAY
- Contains IC : 4389B-WYSACVLAY

d) Please indicate your product name at any location on the exterior of the host product or product packaging or product literature, which shall be available with the host product or online.

e) This product is certified under the conditions of using channels 1(2412MHz) to 11(2462MHz). Please set the region as CANADA or other which uses channels from 1 to 11. If channels 12(2467MHz) or 13(2472MHz) are used, it may violate the radio regulations.

Ce produit est certifié pour une utilisation sur les canaux 1 (2412MHz) à 11 (2462MHz). Veuillez choisir la région CANADA ou toute autre région utilisant uniquement ces canaux.

L'utilisation sur les canaux 12 (2467MHz) ou 13 (2472MHz) peut constituer une violation des règlements sur les radiocommunications.

⑬ FCC Regulatory Information

a) This device complies with part 15 of the FCC Rules. Operation is subject to the following two conditions:

- (1) This device may not cause harmful interference, and (2) this device must accept any interference received, including interference that may cause undesired operation.

TAIYO YUDEN CO., LTD.

WYSACVLAY-WX

TAIYO YUDEN CO., LTD.

Control No. HD-AG-A191017	(6/8)	Control name General Items
------------------------------	-------	-------------------------------

b) Please notify certified ID by either one of the following method.

- Contains Transmitter Module FCC ID: RYYWYSACVLAY
- Contains FCC ID: RYYWYSACVLAY

c) TCAUTION: changes or modifications not expressly approved by the party responsible for compliance could void the user's authority to operate the equipment.

d) This equipment complies with FCC radiation exposure limits set forth for an uncontrolled environment and meets the FCC radio frequency (RF) Exposure Guidelines. This equipment should be installed and operated keeping the radiator at least 20cm or more away from person's body.

e) The antenna used for this transmitter must not be co-located or operating in conjunction with any other antenna or transmitter.

f) This module can change the output power depending on the circumstances by the application software which is developed by module installer. Any end user cannot change the output power.

g) This product is certified under the condition of using 1(2412MHz) to 11(2462MHz) channels. Region is set to US as default and 1 to 11 channels are used. Please set the region as default (US) and do not change. If 12(2467MHz) or 13(2472MHz) channels are used, it may violate the radio regulations.

h) Wireless LAN of this module complies with the following standards:

- FCC part 15 Subpart C (2.4GHz band)

i) This product is FCC approved only as a module. Manufacturers of final devices has a responsibility for the conditions which are not approved as a module. Please carry out the tests of FCC Part 15 Subpart B in case your final device installs this module.

j) Co-location of this module with other transmitters that operate simultaneously are required to be evaluated using the FCC multi transmitter procedures. When installing this module to your final devices, please make sure to carry out all the necessary evaluations according to the applicable guidelines like follows:

- for RF exposure: KDB 447498, KDB 996369 and any other relevant guidelines
- for EMC: KDB 996369 D04 and any other relevant guidelines

k) When you install this module to your final devices, please ensure that your final composite product complies with the applicable FCC rules in reference to a guidance in KDB 996369.

l) When you install this module to your final devices, please ensure to perform all the required equipment authorization and testing for the technical parameters which are not covered by the module grant (e.g., unintentional radiator Part 15 Subpart B requirements, or transmitters used in the host which are not previously approved as modules).

TAIYO YUDEN CO., LTD.

WYSACVLAY-WX

TAIYO YUDEN CO., LTD.

Control No. HD-AG-A191017	(7/8)	Control name General Items
------------------------------	-------	-------------------------------

m) Antenna List

This module is approved along with the following antennas.

You cannot use any antennas other than the listed ones because it deviates from the accredited conditions

No.	Manufacture	Part No.	Antenna	Antenna Gain
1	TAIYO YUDEN	N/A (Printed on PCB)	Monopole	-2.9dBi @2.4GHz Band

⑭ CE Regulatory Information

a) When your end product installs this module, it is required to proceed additional certification processes before placing on the market in EU member states to make your products fully comply with relative EU standards. Additionally, if your end product is subject to the restrictions of RE Directive, Article 10.10, it is required to display the required information in addition to the certification processes.

Referenced regulations:

- Directive 2014/53/EU
- COMMISSION IMPLEMENTING REGULATION (EU) 2017/1354 of 20 July 2017 specifying how to present the information provided for in Article 10(10) of Directive 2014/53/EU of the European Parliament and of the Council

Restrictions to this product (as of June, 2018):

- Radio LAN operating in 5.15 – 5.35 GHz: restricted to indoor use only

Above regulations are referenced as of the issue date of this document. Since the aforementioned regulations have possibilities to be modified and added in the future, please make sure that you should always confirm the latest regulations.

b) TAIYO YUDEN can provide you the test reports of conducted measurement portion for the radio module. You can utilize the test reports for the certification processes of your end product as it requires radio testing.

⑮ France Regulatory Information

This radio module complies with European radiation exposure limits set forth for an uncontrolled environment and meets the European radio frequency exposure regulations. This radio module should be installed and operated keeping the radiator at least 20cm or more away from human body. When using this radio module within 20cm from human body, it can be required to proceed additional testing or evaluation for Specific Absorption Rate (SAR). When performing the additional SAR test or evaluation, please indicate the SAR value on your user instructions in a legible, intelligible and visible manner if your final device is being put into service and intended to be used in France.

WYSACVLAY-WX

TAIYO YUDEN CO., LTD.

Control No. HD-AG-A191017	(8/8)	Control name General Items
------------------------------	-------	-------------------------------

Referenced regulations (France)

-Order of amending the Order of 8 October 2003 on consumer information regarding radio terminal equipment issued pursuant to Article R20-10 of the Postal and Telecommunications Code, the Order of 8 October 2003 setting out the technical specifications applicable to radio terminal equipment and the Order of 12 October 2010 on displaying the specific absorption rate of radio terminal equipment

-Order of 8 October 2003 on consumer information regarding radio terminal equipment issued pursuant to Article R20-10 of the Postal and Telecommunications Code

-Order of 8 October 2003 setting out the technical specifications applicable to radio terminal equipment

-Order of 12 October 2010 on displaying the specific absorption rate of radio terminal equipment

Above regulations are referenced as of the issue date of this document. Since the aforementioned regulations have possibilities to be modified and added in the future, please make sure that you should always confirm the latest regulations.

WYSACVLAY-WX

TAIYO YUDEN CO., LTD.

Control No. HD-AM-A191017 (1/1)	Control name Absolute maximum ratings
---------------------------------------	--

Absolute maximum ratings

Item	Symbol	Rating				Remark
		Min.	Typ.	Max.	Unit	
Supply voltage 1	VIO	-		3.63	V	
Supply voltage 2	VIOH	-		3.63	V	
Supply voltage 3	VIOF	-		3.63	V	
Supply voltage 4	V33	-		3.63	V	
Storage temperature range	Tstg	-40		85	Degrees C	
Operation temperature range	Topr	-30	25	85	Degrees C	

Recommendation operating range

Item	Symbol	Rating				Remark
		Min.	Typ.	Max.	Unit	
Supply voltage 1	VIO	3.0	3.3	3.6	V	
Supply voltage 2	VIOH	3.0	3.3	3.6	V	
Supply voltage 3	VIOF	3.0	3.3	3.6	V	
Supply voltage 4	V33	3.0	3.3	3.6	V	

Built in flash memory characteristics

Item	Rating				Remark
	Min.	Typ.	Max.	Unit	
Write/Erase Cycle	10,000	-	-	Times	

WYSACVLAY-WX

TAIYO YUDEN CO., LTD.

Control No. HD-AE-A191017 (1/4)	Control name Electrical characteristics
---------------------------------------	--

DC Specifications

Peak Current / Power consumption

The Specification applies for Topr.= 25 degrees C, Supply voltage=Typical voltage

No.	Parameter	Condition	Symbol	Min.	Typ.	Max.	Unit	Remark
1	Peak Current	V33 peak current	Ip1	-	-	400	mA	
2	Power consumption3	Burst Tx (72.2Mbps)	Pc3	-	267	-	mW	Duty 4.2%
3	Power consumption4	Continuous Rx (72.2Mbps)	Pc4	-	271	-	mW	
4	Power consumption5	Burst Tx (54Mbps)	Pc5	-	347	-	mW	Duty 25.4%
5	Power consumption6	Continuous Rx (54Mbps)	Pc6	-	267	-	mW	
6	Power consumption7	Burst Tx (11Mbps)	Pc7	-	545	-	mW	Duty 46.8%
7	Power consumption8	Continuous Rx (11Mbps)	Pc8	-	267	-	mW	
8	Power consumption9	Sleep (MPU: Stand By (Low Power Mode in PM2) WLAN: Deep sleep)	Pc9	-	2	-	mW	

Digital Pad Ratings

No.	Parameter	Condition	Symbol	Min.	Typ.	Max.	Unit	Remark
1	Input high voltage		VIH	0.7*VIO	-	VIO+0.4	V	Note1
				0.7*VIOH	-	VIOH+0.4	V	Note2
2	Input low voltage		VIL	-0.4	-	0.3*VIO	V	Note1
				-0.4	-	0.3*VIOH	V	Note2
3	Output high voltage	I _{OH} =3mA	VOH	VIO-0.5V	-	-	V	Note1
				VIOH-0.5V	-	-	V	Note2
4	Output low voltage	I _{OL} =4mA	VOL	-	-	0.4	V	

Note1: Apply to IO pads which IO domain is VIO.

Note2: Apply to IO pads which IO domain is VIOH.

WYSACVLAY-WX

TAIYO YUDEN CO., LTD.

Control No. HD-AE-A191017 (2/4)	Control name Electrical characteristics
------------------------------------	--

AC Specifications

Power on sequence

	Parameter	Condition	Symbol	Min	Typ	Max	Unit	Remark
1	Valid Power to RESETN de-asserted		Tpor	300	-	-	mS	

V33 should be powered up with or before VIOH or VIO or VIOF.

RESETn must remain asserted for minimum of Tpor after V33 and VIOH, VIO, VIOF are stable.

V33, VIOH, VIO and VIOF should start up from less than 0.15V.

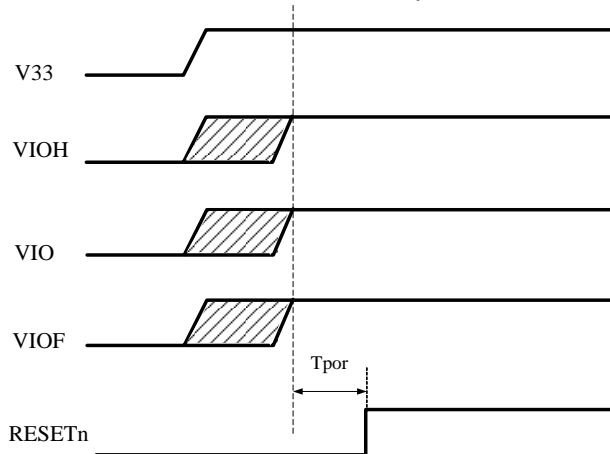

Power off sequence

V33 should be powered off with or after VIOH or VIO or VIOF.

RESETn should not exceed VIO+0.4V.

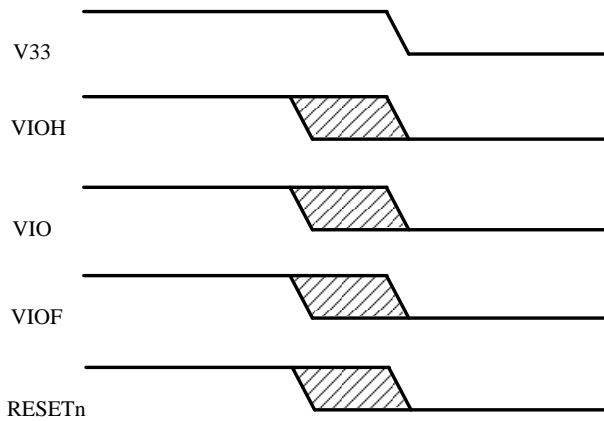

RESETn Pulse Width

Parameter	Condition	Symbol	Min	Typ	Max	Unit
Minimum reset pulse width on RESETn pin	-	Trpw	300			Ms

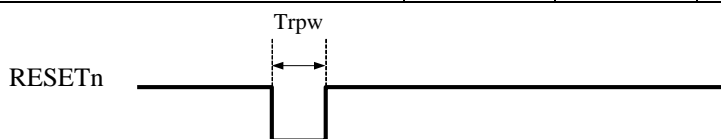

WYSACVLAY-WX

TAIYO YUDEN CO., LTD.

Control No. HD-AE-A191017 (3/4)	Control name Electrical characteristics
------------------------------------	--

RF Specifications (WLAN 11n/72.2Mbps, OFDM)

The Specification applies for Ta=25 degrees C, Supply voltage =Typical voltage.

No.	Parameter	Condition	Symbol	Min	Typ	Max	Unit	Remark
1	RF frequency range		FREQ	2412		2462	MHz	
2	TX Power		Po	7	9	11	dBm	Note1
3	Spectrum Mask	1 st Side Lobe	M1	-		-20	dBc	
		2 nd Side Lobe	M2	-		-28	dBc	
		3 rd Side Lobe	M3	-		-45	dBc	
4	Symbol clock tolerance		Ft	-25		25	ppm	
5	Frequency tolerance		Ft	-25		25	ppm	
6	EVM	Rms	EVM	-		-28	dB	
7	TX Out of band spurious1	30MHz to 1GHz	TOS1	-		-36	dBm	
8	TX Out of band spurious2	1GHz to 12.75GHz	TOS2	-		-30	dBm	
9	TX Out of band spurious3	1.8GHz to 1.9GHz 5.15GHz to 5.3GHz	TOS3			-47	dBm	
10	Rx sensitivity	PER<10%	SEN	-	-68	-64	dBm	
11	Maximum Input Level	PER<10%	MIL	-20		-	dBm	
12	RX Out of band spurious1	30MHz to 1GHz	ROS1	-		-57	dBm	
13	RX Out of band spurious2	1GHz to 12.75GHz	ROS2	-		-47	dBm	

Note1:Tx power should be set as typical value. If not, it may violate radio regulations of each country.

RF Specifications (WLAN 11g/54Mbps, OFDM)

The Specification applies for Ta=25 degrees C, Supply voltage =Typical voltage

No.	Parameter	Condition	Symbol	Min	Typ	Max	Unit	Remark
1	RF frequency range		FREQ	2412		2462	MHz	
2	TX Power		Po	7	9	11	dBm	Note2
3	Spectrum Mask	1 st Side Lobe	M1	-		-20	dBc	
		2 nd Side Lobe	M2	-		-28	dBc	
		3 rd Side Lobe	M3	-		-40	dBc	
4	Symbol clock tolerance		Ft	-25		25	ppm	
5	Frequency tolerance		Ft	-25		25	ppm	
6	EVM	Rms	EVM	-		-25	dB	
7	TX Out of band spurious1	30MHz to 1GHz	TOS1	-		-36	dBm	
8	TX Out of band spurious2	1GHz to 12.75GHz	TOS2	-		-30	dBm	
9	TX Out of band spurious3	1.8GHz to 1.9GHz 5.15GHz to 5.3GHz	TOS3			-47	dBm	
10	Rx sensitivity	PER<10%	SEN	-	-71	-65	dBm	
11	Maximum Input Level	PER<10%	MIL	-20		-	dBm	
12	RX Out of band spurious1	30MHz to 1GHz	ROS1	-		-57	dBm	
13	RX Out of band spurious2	1GHz to 12.75GHz	ROS2	-		-47	dBm	

Note2: Tx power should be set as typical value. If not, it may violate radio regulations of each country.

WYSACVLAY-WX

TAIYO YUDEN CO., LTD.

Control No. HD-AE-A191017	(4/4)	Control name Electrical characteristics
------------------------------	-------	--

RF Specifications (WLAN 11b/11Mbps, CCK)

The Specification applies for Ta=25 degrees C, Supply voltage=Typical voltage

No	Parameter	Condition	Symbol	Min	Typ	Max	Unit	Remark
1	RF frequency range		FREQ	2412		2462	MHz	
2	TX Power		Po	13	15	17	dBm	Note1
3	Spectrum Mask	1 st Side Lobe	M1	-		-30	dBc	
		2 nd Side Lobe	M2	-		-50	dBc	
4	Power up-down rump	Power up	TU	-		2	us	
		Power down	TD	-		2	us	
5	Frequency tolerance		Ft	-25		25	ppm	
6	EVM	Peak	EVM	-		35	%	
7	TX Out of band spurious1	30MHz to 1GHz	TOS1	-		-36	dBm	
8	TX Out of band spurious2	1GHz to 12.75GHz	TOS2	-		-30	dBm	
9	TX Out of band spurious3	1.8GHz to 1.9GHz 5.15GHz to 5.3GHz	TOS3			-47	dBm	
10	Rx sensitivity	PER<8%	SEN		-86	-76	dBm	
11	Maximum Input Level	PER<8%	MIL	-10			dBm	
12	RX Out of band spurious1	30MHz to 1GHz	ROS1	-		-57	dBm	
13	RX Out of band spurious2	1GHz to 12.75GHz	ROS2	-		-47	dBm	

Note1: Tx power should be set as typical value. If not, it may violate radio regulations of each country.

WYSACVLAY-WX

TAIYO YUDEN CO., LTD.

Control No. HD-MC-A191017	(1/2)	Control name Circuit Schematic
------------------------------	-------	-----------------------------------

Block Diagram

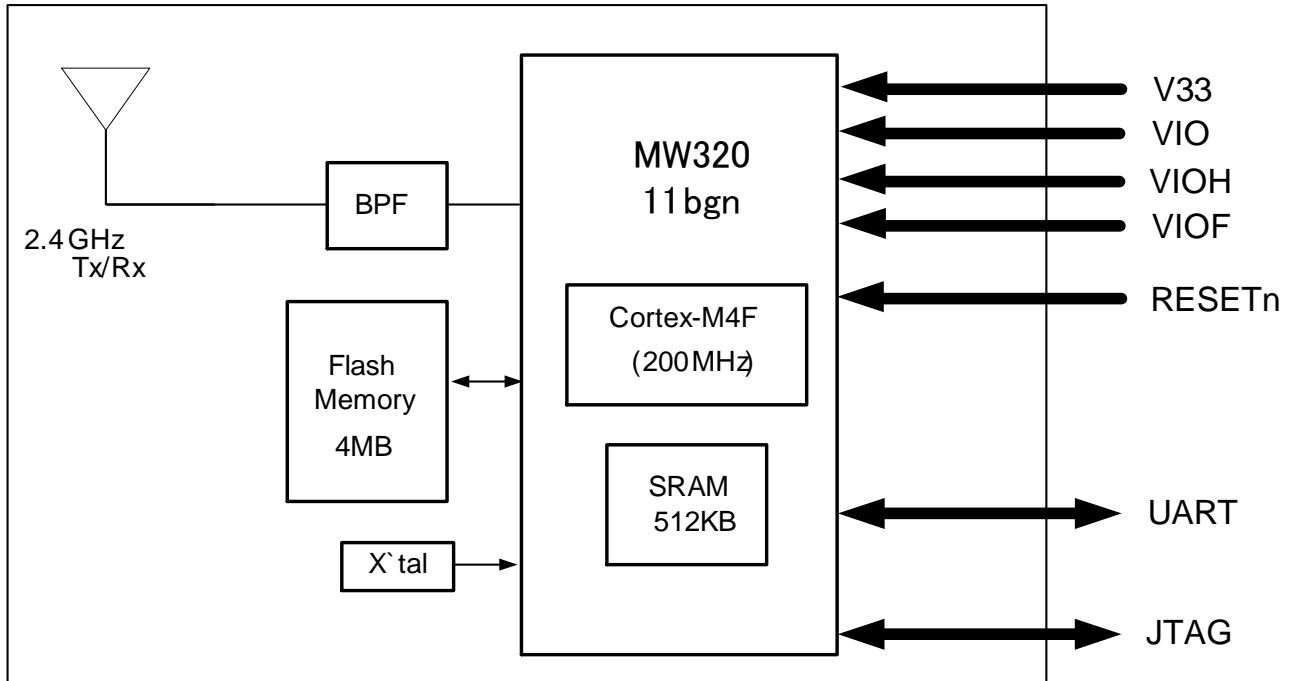

WYSACVLAY-WX

TAIYO YUDEN CO., LTD.

Control No. HD-MC-A191017	(2/2)	Control name Circuit Schematic
------------------------------	-------	-----------------------------------

Example of peripheral circuit schematics

HOST interface : UART 1

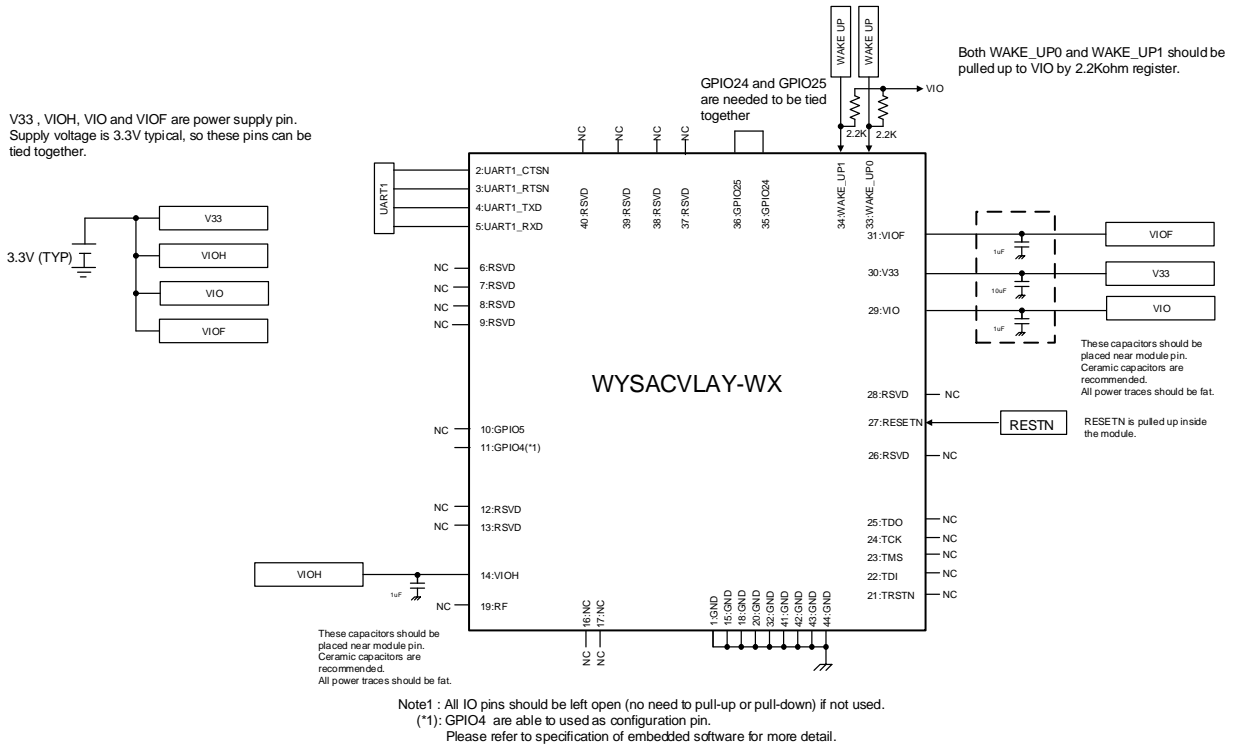

WYSACVLAY-WX

TAIYO YUDEN CO., LTD.

Control No. HD-AD-A191017	(1/5)	Control name Outline/Appearance
------------------------------	-------	------------------------------------

OUTLINE

Unit: mm, Tolerances unless otherwise specified:

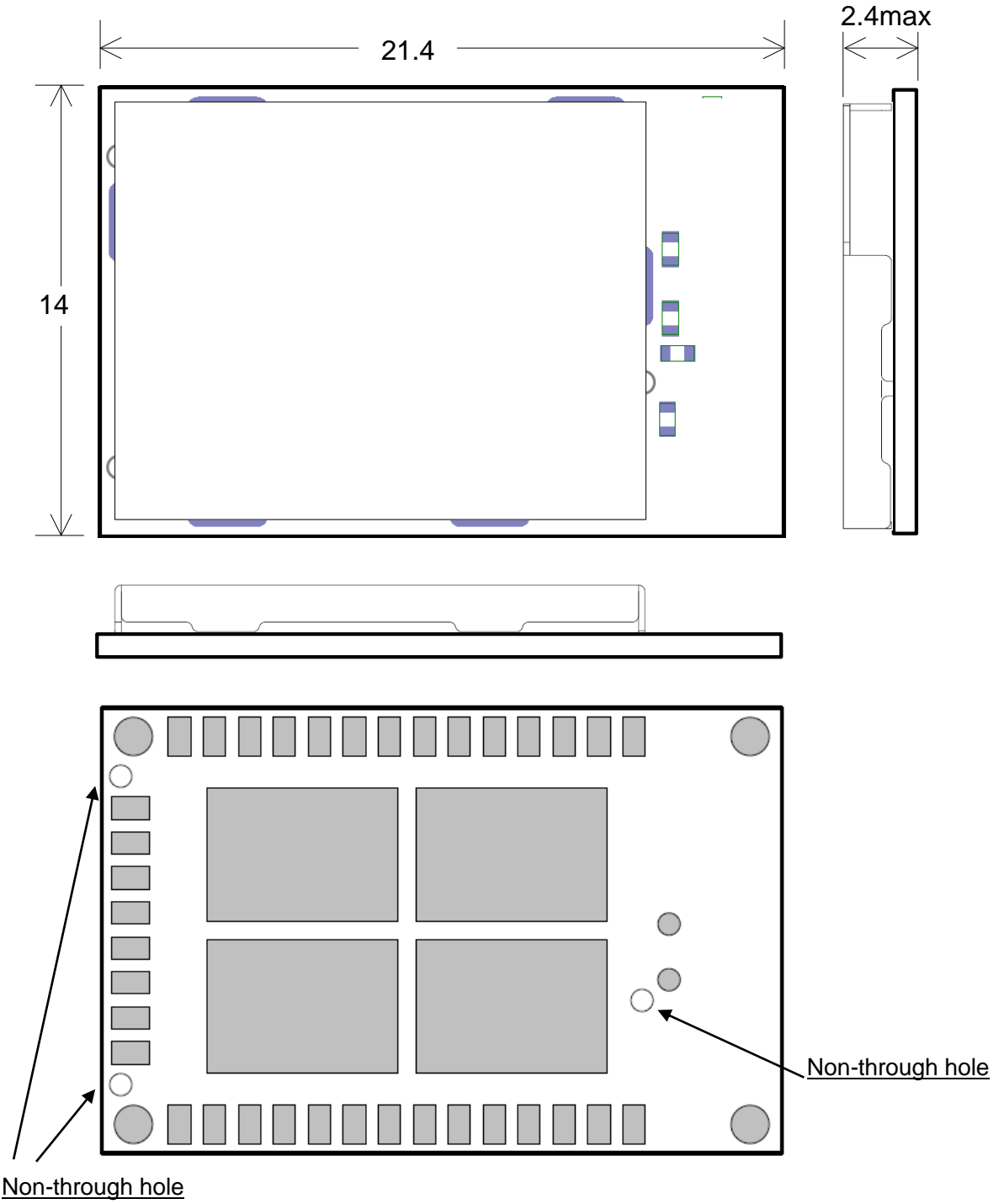

(TOP VIEW)

WYSACVLAY-WX

TAIYO YUDEN CO., LTD.

Control No. HD-AD-A191017	(2/5)	Control name Outline/Appearance
------------------------------	-------	------------------------------------

Indication of Shield Case

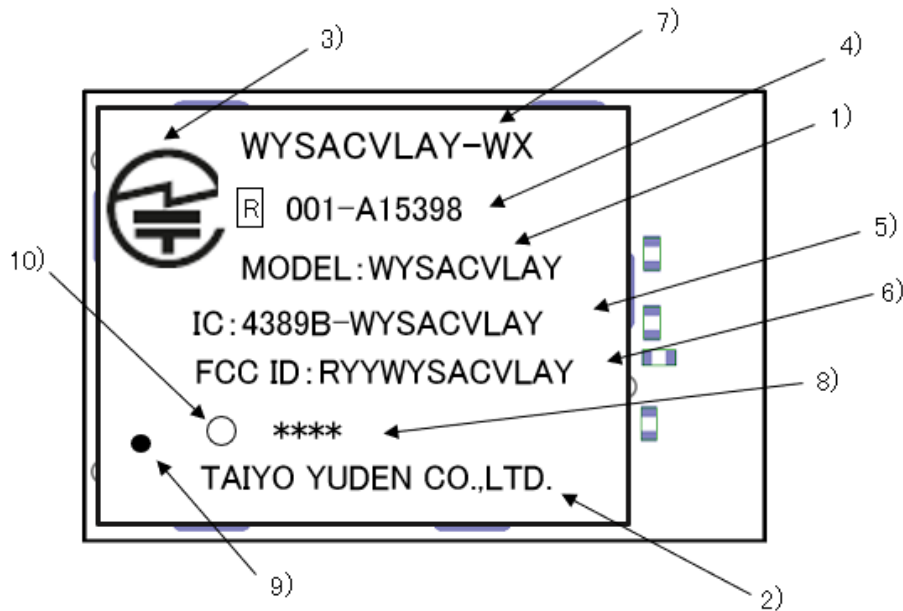

- | | | |
|-----|------------------|---|
| 1) | Model | : WYSACVLAY |
| 2) | Manufacture | : TAIYO YUDEN CO.,LTD. |
| 3) | Japan logo mark | : Specified logo mark |
| 4) | Japan ID | : 001-A15398 |
| 5) | IC ID | : 4389B-WYSACVLAY |
| 6) | FCC ID | : RYYWYSACVLAY |
| 7) | Part Number | : WYSACVLAY-WX |
| 8) | Lot number | : Four digits |
| 9) | 1pin mark | : $\phi 0.6\text{mm}$ hole on the shield case |
| 10) | Identifying mark | |

WYSACVLAY-WX

TAIYO YUDEN CO., LTD.

Control No. HD-AD-A191017	(3/5)	Control name Outline/Appearance
------------------------------	-------	------------------------------------

Module Pad Dimension

Unit: mm

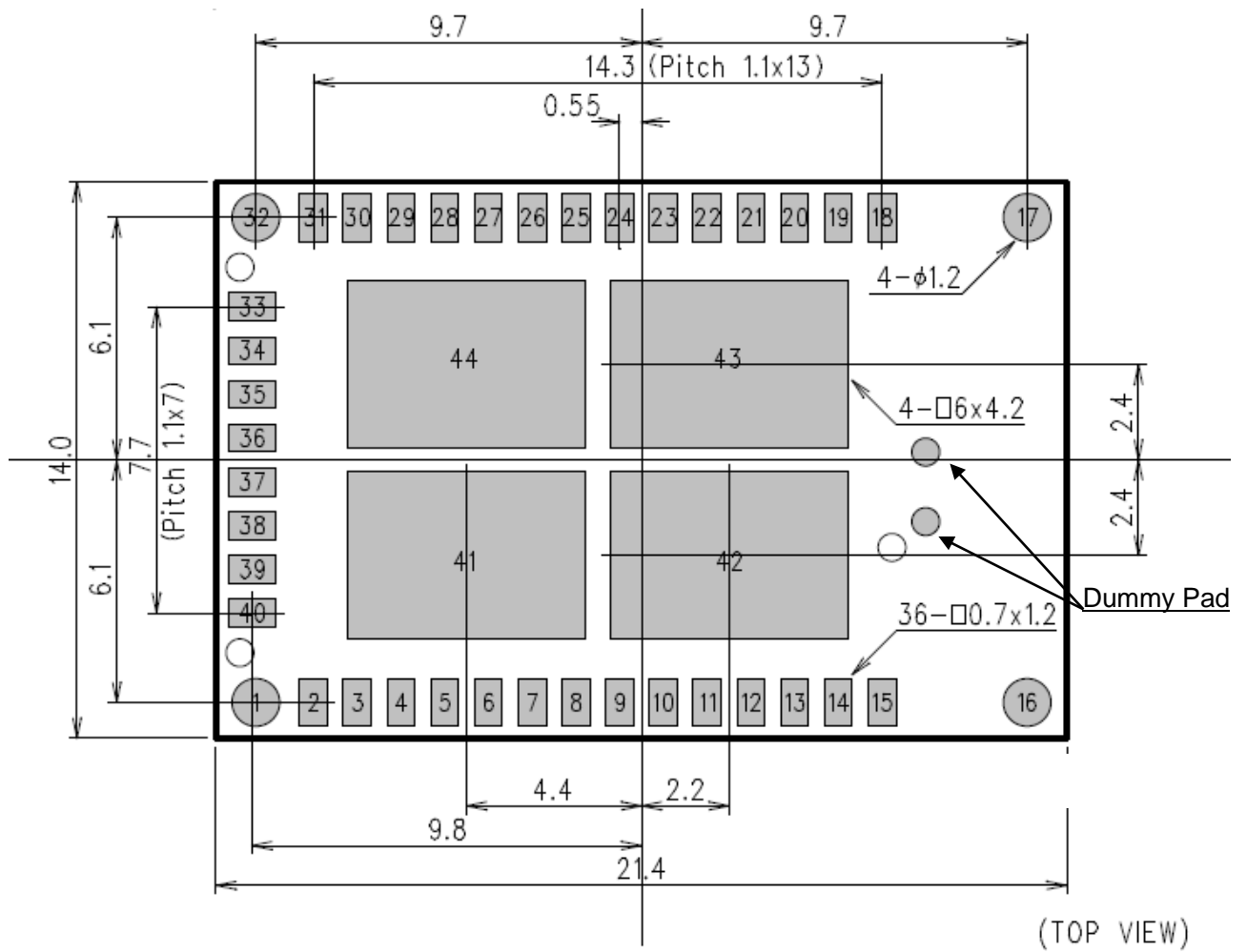

WYSACVLAY-WX

TAIYO YUDEN CO., LTD.

Control No. HD-AD-A191017	(4/5)	Control name Outline/Appearance
------------------------------	-------	------------------------------------

Recommended Land Pattern Dimension

We recommend that pad sizes on mother board and pad sizes on module should be the same except for Pad-16 and Pad-17. Pad-16 and Pad-17 are not needed to solder on mother board and Land patterns for these pads are not needed.

Unit: mm

(Top View)

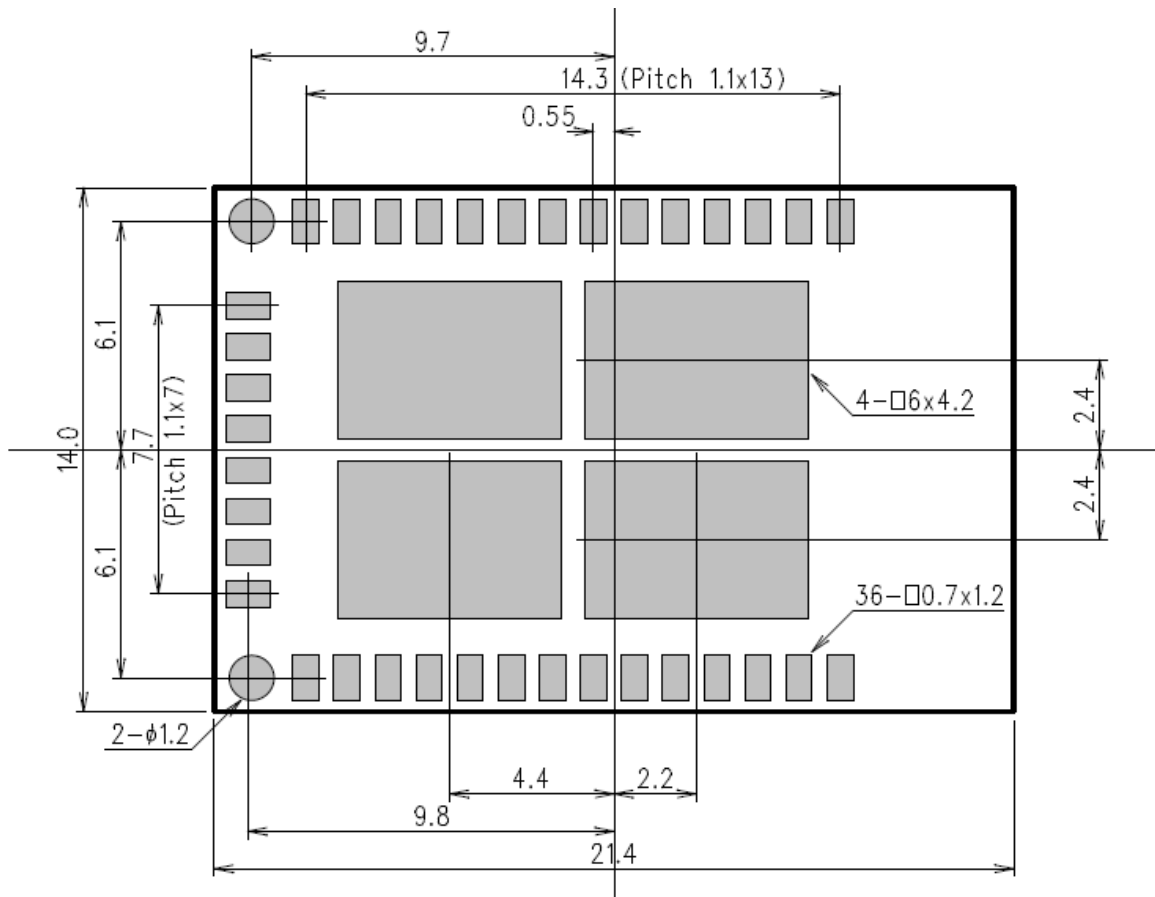

WYSACVLAY-WX

TAIYO YUDEN Co., LTD.

Control No. HD-AD-A191017	(5/5)	Control name Outline/Appearance
------------------------------	-------	------------------------------------

Recommended Metal Mask (Solder Mask) Conditions

Mask size see bellow. Thickness of the Metal Mask should be in the range 0.1 mm

Unit: mm

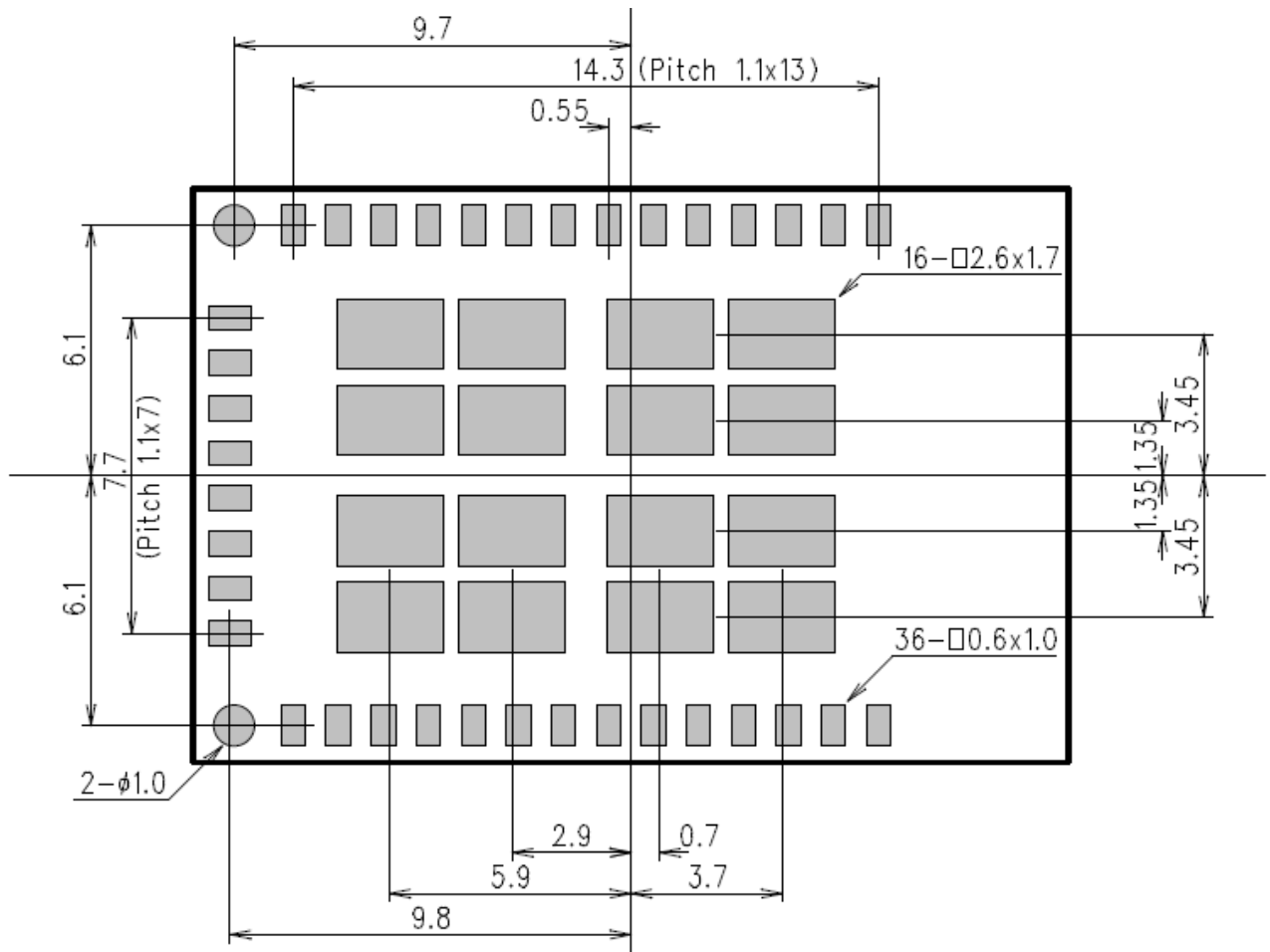

WYSACVLAY-WX

TAIYO YUDEN Co., LTD.

Control No. HD-BA-A191017	(1/2)	Control name Pin Layout
------------------------------	-------	----------------------------

Pin layout

Pin No	module pin name	type	power domain	Description	Note
1	GND	-	Ground	GND	
2	UART1_CTSn	I	VIO	UART1 CTSn (L:Clear to send, H:Not clear to send)	
3	UART1_RTSn	O	VIO	UART1 RTSn(L:Request to send, H:Not request to send)	
4	UART1_TXD	O	VIO	UART1 TXD	
5	UART1_RXD	I	VIO	UART1 RXD	
6	RSVD	-	-	No Connect. Should be left open	
7	RSVD	-	-	No Connect. Should be left open	
8	RSVD	-	-	No Connect. Should be left open	
9	RSVD	-	-	No Connect. Should be left open	
10	GPIO5	I	VIOH	Not used. Should be left open	Not used
11	GPIO4	I	VIOH	Used to force initialization. ^(*)	
12	RSVD	-	-	No Connect. Should be left open.	
13	RSVD	-	-	No Connect. Should be left open.	
14	VIOH	I	VIOH	I/O Digital Power Supply	
15	GND	-	Ground	GND	
16	N.C	-	-	Dummy pad. No connect and do not solder.	
17	N.C	-	-	Dummy pad. No connect and do not solder.	
18	GND	-	Ground	GND	
19	RF	I/O	-	WLAN RF Interface (2.4 GHz Transmit/Receive) Should be left open and do not trace longer than land pattern.	
20	GND	-	Ground	GND	
21	TRSTn	I	VIOH	JTAG-TRSTN (Active L)	Not used
22	TDI	I	VIOH	JTAG-TDI	Not used
23	TMS	I	VIOH	JTAG-TMS	Not used
24	TCK	I	VIOH	JTAG-TCK	Not used
25	TDO	O	VIOH	JTAG-TDO	Not used
26	RSVD	-	-	No Connect. Should be left open.	

WYSACVLAY-WX

TAIYO YUDEN Co., LTD.

Control No. HD-BA-A191017	(2/2)	Control name Pin Layout
------------------------------	-------	----------------------------

Pin No	module pin name	type	power domain	Description	Note
27	RESETn	I	VIO	RESET signal (Active low) Pulled up to VIO by 51K ohm register inside the module.	
28	RSVD	-	-	No Connect. Should be left open.	
29	VIO	I	VIO	I/O Digital Power Supply	
30	V33	I	V33	3.3V Power Supply	
31	VIOF	I	VIO_F	I/O Digital Power Supply	
32	GND	-	Ground	GND	
33	WAKE_UP0	I	VIO	Wakeup-0 signal (Active L). Should be pulled up to VIO with 2.2K ohm register outside the module.	
34	WAKE_UP1	I	VIO	Wakeup-1 signal (Active L). Should be pulled up to VIO with 2.2K ohm register outside the module.	
35	GPIO24	I/O	VIO	GPIO24 and GPIO25 are used to calibrate RC32k inside the module. Tie GPIO24 and GPIO25 outside the module and do not tie other signal.	
36	GPIO25	I/O	VIO	GPIO24 and GPIO25 are used to calibrate RC32k inside the module. Tie GPIO24 and GPIO25 outside the module and do not tie other signal.	
37	RSVD	-	-	No Connect. Should be left open.	
38	RSVD	-	-	No Connect. Should be left open.	
39	RSVD	-	-	No Connect. Should be left open.	
40	RSVD	-	-	No Connect. Should be left open.	
41	GND	-	Ground	GND	
42	GND	-	Ground	GND	
43	GND	-	Ground	GND	
44	GND	-	Ground	GND	

Note: IO pins should be left open if not used, unless otherwise noted.

(*1) Please refer to the specification of embedded software for more detail.

WYSACVLAY-WX

TAIYO YUDEN Co., LTD.

Control No. HQ-BA-537	(1/2)	Control name Handling Precaution
--------------------------	-------	-------------------------------------

This specification describes desire and conditions especially for mounting.

Desire/Conditions

(1) Environment conditions for use and storage

1. Store the components in an environment of < **40deg-C/90%RH** if they are in a moisture barrier bag packed by TAIYO YUDEN.
2. Keep the factory ambient conditions at < **30deg-C/60%RH**.
3. Store the components in an environment of < **25±5deg-C/10%RH** after the bag is opened.
(The condition is also applied to a stay in the manufacture process).

(2) Conditions for handling of products

Make sure all of the moisture barrier bags have no holes, cracks or damages at receiving. If an abnormality is found on the bag, its moisture level must be checked in accordance with 2 in (2).

Refer to the label on the bag.

1. All of the surface mounting process (reflow process) must be completed **in 12 months** from the bag sea date.
2. Make sure humidity in the bag is less than **10%RH** immediately after open, using a humidity indicator card sealed with the components.
3. **All** of the surface mounting process (reflow process including rework process) must be completed in **168 hours** after the bag is opened (inclusive of any other processes).
4. If any conditions in (1) or condition 2 and 3 in (2) are not met, bake the components in accordance with the conditions at **125deg-C 24hours**
5. As a rule, baking the components in accordance with conditions 4 in (2) shall be once.
6. Since semi-conductors are inside of the components, they must be free from static electricity while handled.(<100V) Use ESD protective floor mats, wrist straps, ESD protective footwear, air ionizers etc. , if necessary.
7. Please make sure that there are lessen mechanical vibration and shock for this module, and do not drop it.
8. Please recognize pads of back side at surface mount.
9. Washing the module is not recommended. If washing cannot be avoided, please test module functionality and performance after thoroughly drying the module. We cannot be held responsible for any failure due washing the module..
10. Please perform temperature conditions of module at reflow within the limits of the following.
Please give the number of times of reflow as a maximum of 2 times.

WYSACVLAY-WX

TAIYO YUDEN Co., LTD.

Control No. HQ-BA-537	(2/2)	Control name Handling Precaution
--------------------------	-------	-------------------------------------

Recommended Reflow Profile

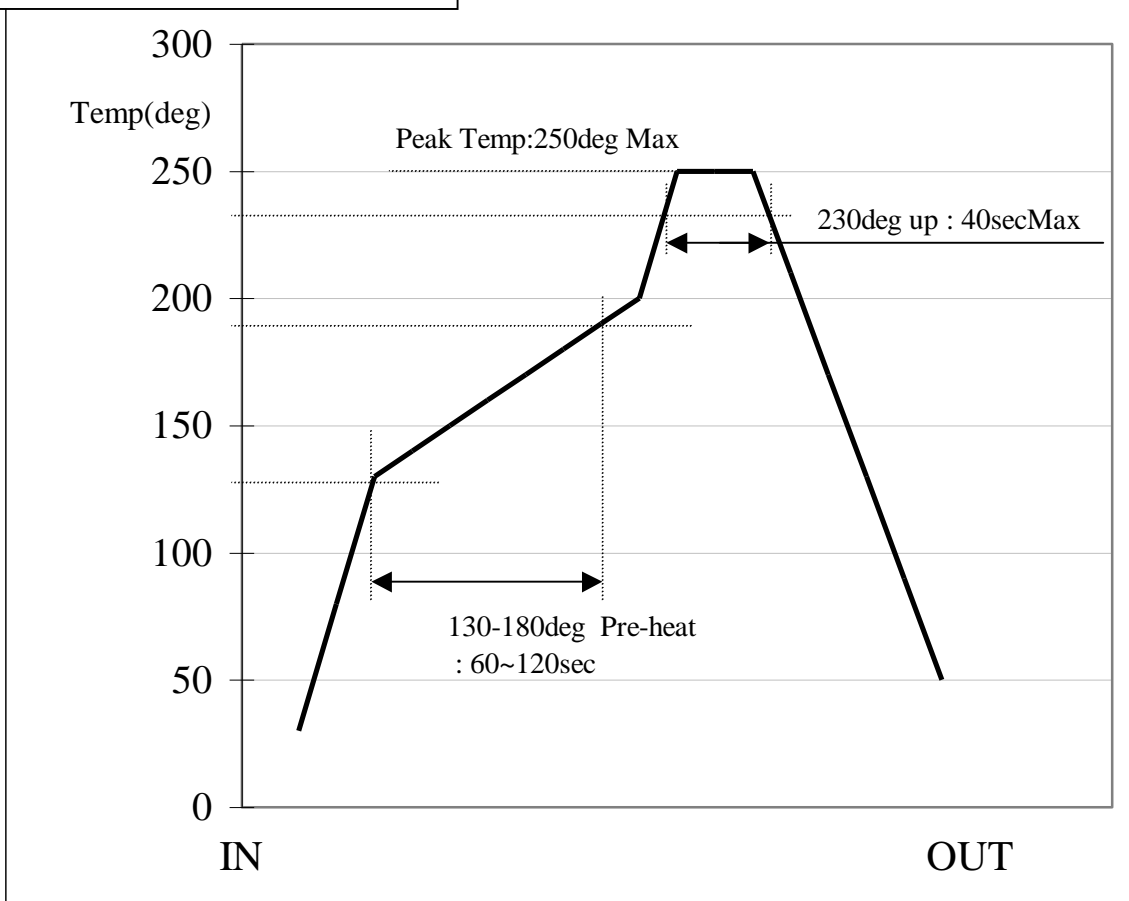

WYSACVLAY-WX

TAIYO YUDEN Co., LTD.

Control No. HD-BB-A191017	(1/2)	Control name Packaging Specification
------------------------------	-------	---

Packaging Specification
梱包仕様(1) Packaging Material
梱包材料

Name 部材名	Outline 概要	Materials 材質	Note 備考
Tray トレイ	315 × 135.9 × 7.62(mm)	Conductive PPE 導電性PPE	84 pieces/tray 84 個/トレイ
Antistatic band 帯電防止結束バンド	8mm wide 8mm幅	Antistatic PP 帯電防止 PP	—
Desiccant 乾燥剤	—	Desi-Pak デシパック	—
Humidity indicator card 湿度インジケータ	—	—	—
Aluminum moisture barrier bag アルミ防湿袋	260 × 460(mm)	(AS)PET/AL/NY/PE(AS)	—
Buffer corrugated paper 緩衝ダンボール	—	Corrugated fiberboard. ダンボール	—
Label ラベル	—	—	—
Corrugated cardboard boxx 個装箱	345 × 205 × 95(mm)	Corrugated fiberboard. ダンボール	—

(2) Packaging Unit
梱包数量

$$84 \text{ pieces/tray} \times 10 \text{ tray} = 840 \text{ pieces}$$

$$84 \text{ 個/トレイ} \times 10 \text{ トレイ} = 840 \text{ 個}$$

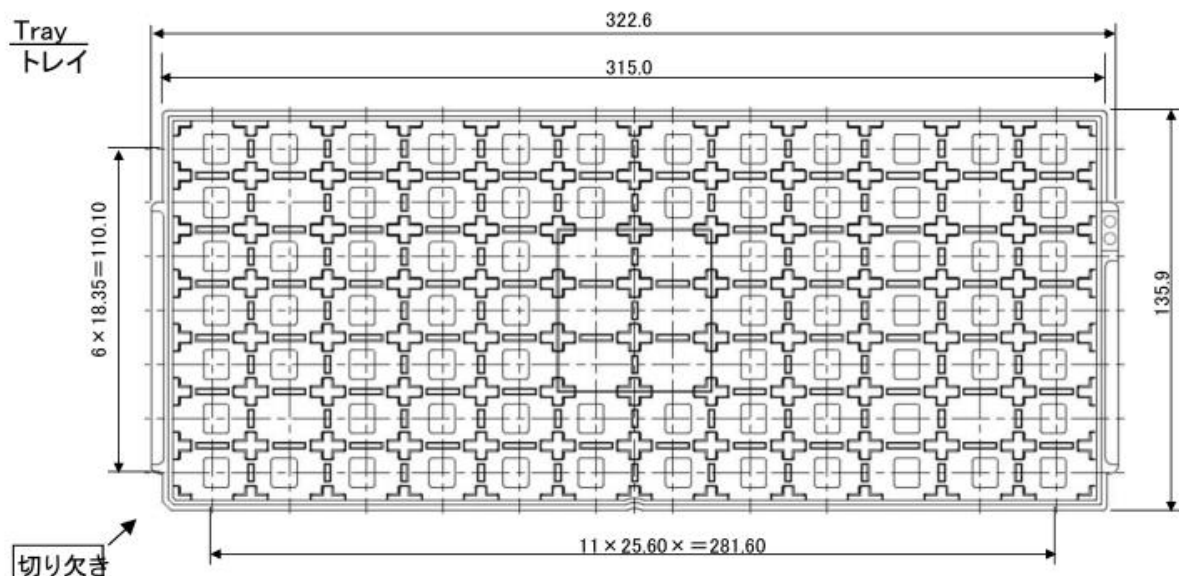
(3) Packaging Figure
梱包形態

WYSACVLAY-WX

TAIYO YUDEN Co., LTD.

Control No. HD-BB-A191017	(2/2)	Control name Packaging Specification
------------------------------	-------	---

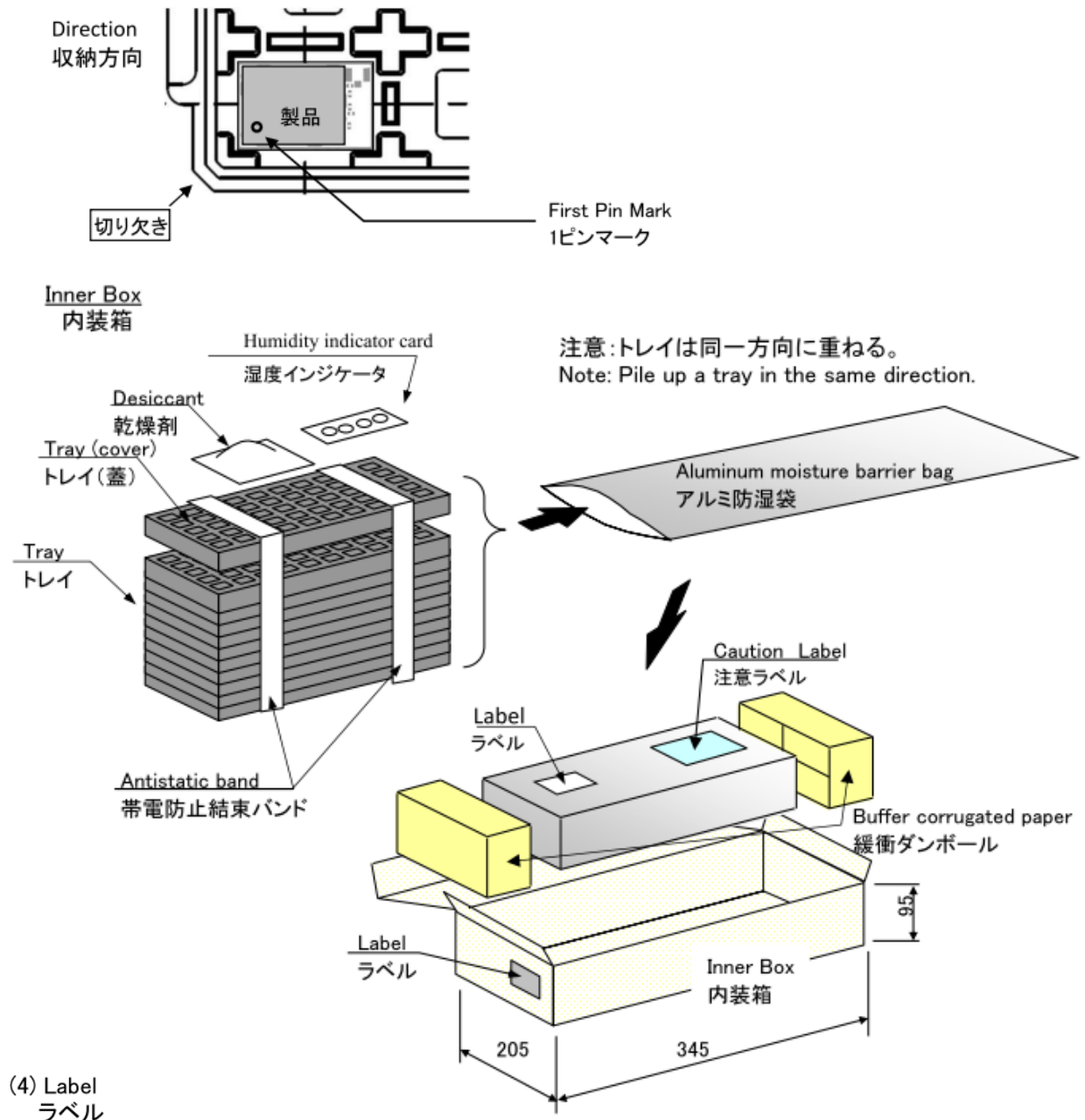

(4) Label
ラベル

The entry item to a label
ラベルへの記載内容

COMPANY NAME	御社名
DESCRIPTION	品名
QUANTITY	納入数量
LotNo.	ロット
NOTE	備考
COUNTRY OF ORIGIN	原産国

WYSACVLAY-WX

TAIYO YUDEN Co., LTD.

Control No. (1/3)	Control name Antenna Application Note
--------------------------	--

1. Recommended module mounting example

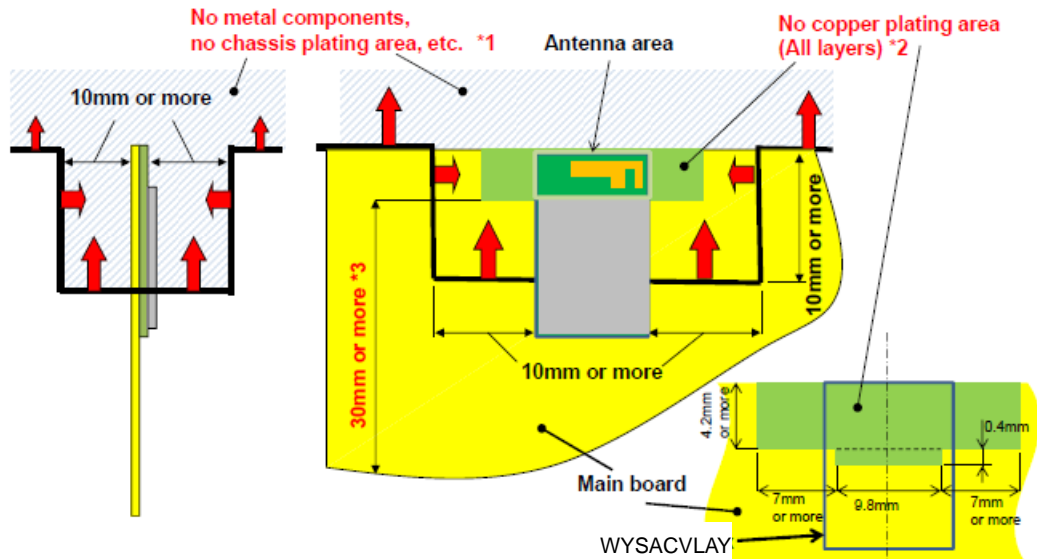

*1 Please do not place any metal components in blue shaded space,(*1) such as signal line and metal chassis as possible except for main board while mounting the components in *1 space on the main board is allowed except for no copper plating area. (*2).
 *2 This area is routing prohibited area on the main board. Please do not place copper on any layer. Please remain use of FR-4 dielectric material. The antenna is tuned with the FR-4.
 *3 Characteristics may deteriorate when GND pattern length is less than 30mm. It should be 30 mm or more as possible.
 Even when above mentioned condition is satisfied, communication performance may be significantly deteriorated depending on the structure of the product.

2. Other module mounting examples

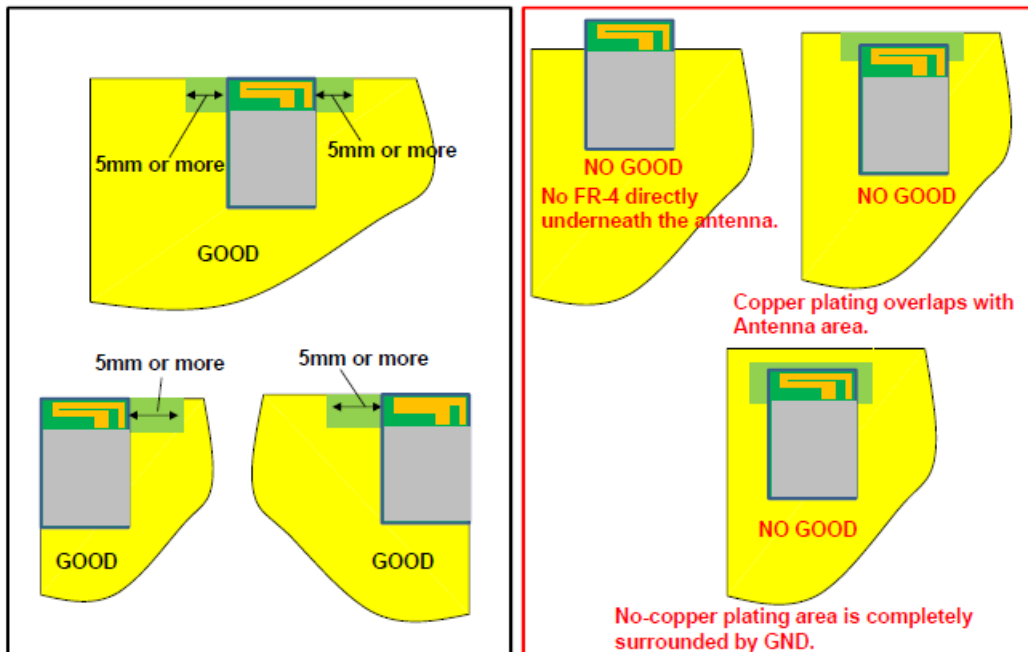

WYSACVLAY-WX

TAIYO YUDEN Co., LTD.

Control No. (2/3)	Control name Antenna Application Note
--------------------------	--

3. Placement of resin or plastic parts

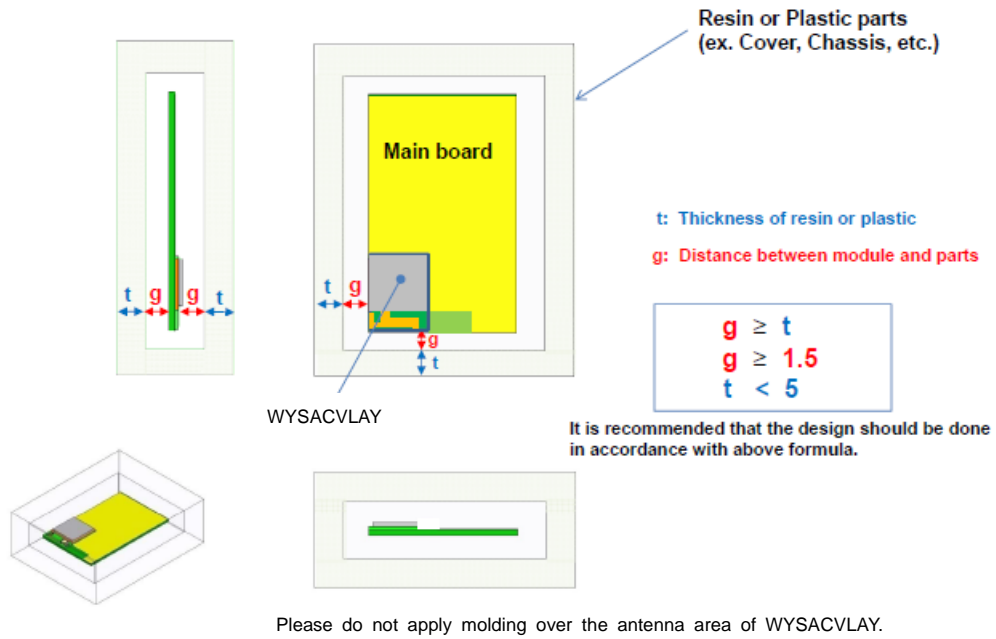

WYSACVLAY-WX

TAIYO YUDEN Co., LTD.

Control No. (3/3)	Control name Antenna Application Note
--------------------------	--

4. Directional characteristics example (when mounted on evaluation board)

Measured in Satimo Stargate system at TAIYO YUDEN R&D CENTER.

Appearance and coordinates definition

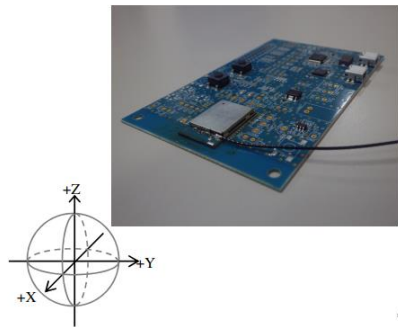

Measurement data of antenna

Frequency [MHz]	@2400	@2450	@2500
Peak gain [dBi]			
3-plane			
TX-H	-2.9	-3.5	-5.8
TX-V	-6.7	-6.5	-8.5
	-2.9	-3.5	-5.8
Average gain [dBi]			
XY-plane			
TX-H	-7.7	-7.6	-9.8
TX-V	-28.0	-27.2	-28.5
Plus(H,V)	-7.6	-7.6	-9.8
YZ-plane			
TX-H	-14.6	-14.0	-14.9
TX-V	-10.1	-9.8	-11.6
Plus(H,V)	-8.8	-8.4	-9.9
ZX-plane			
TX-H	-8.4	-9.2	-11.7
TX-V	-9.5	-9.2	-10.6
Plus(H,V)	-5.9	-6.2	-8.1
3-plane			
TX-H	-9.3	-9.5	-11.7
TX-V	-11.5	-11.2	-12.8
	-7.3	-7.3	-9.2
Efficiency [dB]			
	-6.5	-6.6	-8.6
VSWR [1]			
	1.5	1.9	4.0

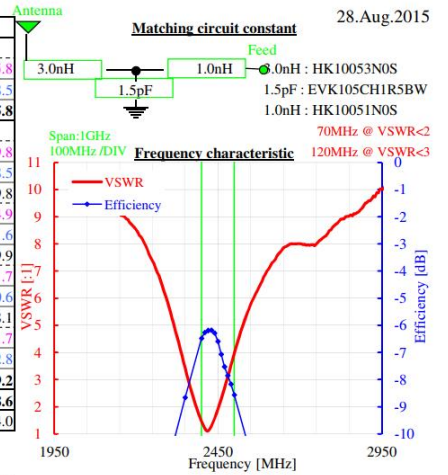

*Note: Peak gain(3-plane)=Peak(XY[H],XY[V],YZ[H],YZ[V],ZX[H],ZX[V])
 *Note:The value is average value in 1 round of each inclination direction angle.
 *Note: Average gain(3-plane)=Average(XY[Plus(H,V)],YZ[Plus(H,V)],ZX[Plus(H,V)])

Radiation pattern

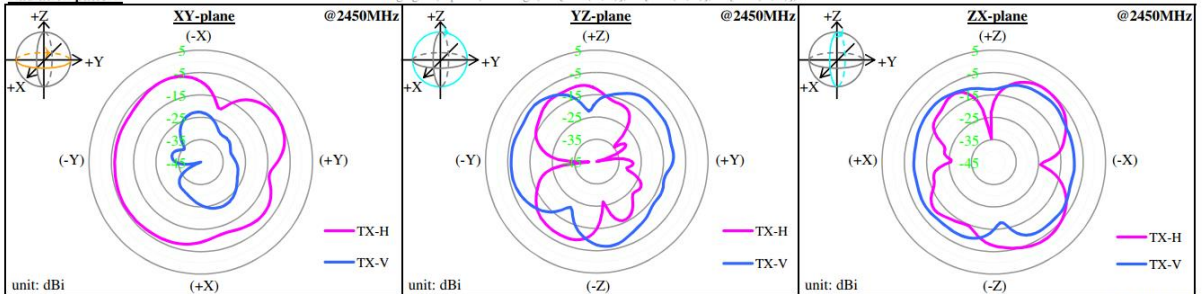

20150828M0982

5. About this Application Note

-This Application Note has been prepared as a reference material to help obtaining the antenna performance mounted on **WYSACVLAY-WX** module better while it is not guaranteed or assured to obtain better communication performance and distance.

-This product "**WYSACVLAY-WX** module" has been certified and matching circuit constant for antenna within module cannot be changed when ambient environment condition changes. The product must be re-certified when matching circuit constant is changed.

その他、注意事項について (Precautions)

- 弊社製品のご使用に際しては、使用する機器に実装された状態および実際の使用環境での評価および確認を必ず行ってください。
- 当仕様書に記載の製品は、一般的な電子機器【AV 機器、OA 機器、家電製品、事務機器、情報・通信機器（携帯電話、パソコンなど）】で使用されることを意図されています。したがって、生命または身体に直接危害を及ぼす可能性のある機器【輸送用機器（自動車駆動制御装置、列車制御装置、船舶制御装置など）、交通用信号機器、防災機器、医療機器（国際分類クラスⅠ、Ⅱ、Ⅲ）、公共性の高い情報通信機器（電話交換機、電話・無線・放送などの基地局）】などへのご使用をご検討の場合は、必ず事前に弊社までお問い合わせをお願いします。

また、高度の安全性や信頼性が求められる機器【宇宙用機器、航空用機器、医療機器（国際分類クラスⅣ）、原子力用制御機器、海底用機器、軍事用機器など】につきましては、弊社製品をご使用されないようお願いします。

なお、一般的な電子機器においても安全性や信頼性の要求が高い機器、回路などに弊社製品をご使用になる場合には、十分な安全性評価を実施され、必要に応じて設計時に保護回路などを追加していただくことをお勧めします。

弊社の書面による事前の承諾を得ることなく、前述の弊社への問い合わせが必要な機器または弊社が使用を禁止する機器に当仕様書に記載の製品を使用したことによりお客様または第三者に生じた損害に関して、弊社は一切の責任を負いかねますのでご了承ください。
- 当仕様書に記載の情報は、製品の代表的動作・応用を説明するためのものであり、その使用に際して弊社および第三者の知的財産権その他の権利に対する保証または実施権の許諾を行うものではありません。
- 弊社製品の保証範囲につきましては、納入された弊社製品単体の保証に限られ、弊社製品の故障や瑕疵から誘発される損害に関して、弊社は一切の責任を負いかねますのでご了承ください。ただし、取引基本契約書、品質保証協定書など別途書面による契約が締結されている場合は、その内容にしたがって保証させていただきます。
- 当仕様書に記載内容につきましては、弊社の営業所・販売子会社・販売代理店（いわゆる「正規販売チャンネル」）からご購入いただいた弊社製品に適用します。上記以外からご購入いただいた弊社製品に関しては適用対象外とさせていただきますのでご了承ください。
- 輸出注意事項
当仕様書に記載の製品の一部には、輸出の際に「外国為替及び外国貿易法」並びに米国の輸出管理関連法規などの規制をご確認の上、必要な手続きをお取りいただく必要のある製品があります。ご不明な場合には弊社までお問い合わせください。
- Please conduct validation and verification of our products in actual condition of mounting and operating environment before using our products.
- The products listed in this specification are intended for use in general electronic equipment (e.g., AV equipment, OA equipment, home electric appliances, office equipment, information and communication equipment including, without limitation, mobile phone, and PC). Please be sure to contact TAIYO YUDEN for further information before using the products for any equipment which may directly cause loss of human life or bodily injury (e.g., transportation equipment including, without limitation, automotive powertrain control system, train control system, and ship control system, traffic signal equipment, disaster prevention equipment, medical equipment classified as Class I, II or III by IMDRF, highly public information network equipment including, without limitation, telephone exchange, and base station).
Please do not incorporate our products into any equipment requiring high levels of safety and/or reliability (e.g., aerospace equipment, aviation equipment, medical equipment classified as Class IV by IMDRF, nuclear control equipment, undersea equipment, military equipment).
When our products are used even for high safety and/or reliability-required devices or circuits of general electronic equipment, it is strongly recommended to perform a thorough safety evaluation prior to use of our products and to install a protection circuit as necessary.
Please note that unless you obtain prior written consent of TAIYO YUDEN, TAIYO YUDEN shall not be in any way responsible for any damages incurred by you or third parties arising from use of the products listed in this specification for any equipment requiring inquiry to TAIYO YUDEN or prohibited for use by TAIYO YUDEN as described above.
- Information contained in this specification is intended to convey examples of typical performances and/or applications of our products and is not intended to make any warranty with respect to the intellectual property rights or any other related rights of TAIYO YUDEN or any third parties nor grant any license under such rights.
- Please note that the scope of warranty for our products is limited to the delivered our products themselves and TAIYO YUDEN shall not be in any way responsible for any damages resulting from a fault or defect in our products. Notwithstanding the foregoing, if there is a written agreement (e.g., supply and purchase agreement, quality assurance agreement) signed by TAIYO YUDEN and your company, TAIYO YUDEN will warrant our products in accordance with such agreement.

HQ-BK-002_02

- The contents of this specification are applicable to our products which are purchased from our sales offices or authorized distributors (hereinafter "TAIYO YUDEN's official sales channel"). Please note that the contents of this specification are not applicable to our products purchased from any seller other than TAIYO YUDEN's official sales channel.
- Caution for Export
Some of our products listed in this specification may require specific procedures for export according to "U.S. Export Administration Regulations", "Foreign Exchange and Foreign Trade Control Law" of Japan, and other applicable regulations. Should you have any questions on this matter, please contact our sales staff.

WLAN Embedded Software Spec.

TAIYO YUDEN Standard Application for WLAN

In case you adopt this module and design some appliance, please ask for the latest specifications from the local sales office.

We wish the customer to request the Specification Report when the design for the mass production begins because the content of this Data Report might change without a previous notice to the customer.

Rev. Record

04-Mar.-2016> Ver.2.00

02-Sep.-2016> Ver.2.01

23-Jun.-2017> Ver.2.02

19-Oct.-2017> Ver.2.03

07-Nov.-2017> Ver.2.04

20-Nov.-2017> Ver.2.05

22-Nov.-2017> Ver.2.06

23-Apr.-2018> Ver.2.07

Revision History

Version	Date	Description
2.00	2016/03/04	First official release
2.01	2016/09/02	Updated content: <ul style="list-style-type: none"> ● Section 4.1 "TCP" : data size ● Section 4.2 "UDP" : data size ● Section 5.9 "Data Transmission" : data size ● Chapter 9 : Note 5, 6
2.02	2017/06/23	Added content: <ul style="list-style-type: none"> ● Chapter 9 : Note 10, 11 ● Chapter 10 : No.5 Updated content: <ul style="list-style-type: none"> ● Section 5.2 "Common Response Events" : DCO response
2.03	2017/10/19	Added content: <ul style="list-style-type: none"> ● Section 5.1 "Common Commands" : SRN , STG , GTG , SCN ● Section 5.2 "Common Response Events" : SHD , GHD , HTT , HTS ● Section 8.6 : HTTP Request ● Section 8.7 : WEB Configuration
2.04	2017/11/07	Updated content: <ul style="list-style-type: none"> ● Section 5.1 "Common Commands" : STC , SHD , SCT ● Section 5.4 "Common Commands" : STI ● Section 5.7 "micro-AP Control Commands" : STU ● Section 6.1 "Common Error Codes" ● Section 5.2 "Common Response Events" : SCN
2.05	2017/11/20	Update content: <ul style="list-style-type: none"> ● Section 5.1 "Common Commands" : SHD , GHD , HTT ● Section 8.6 "HTTP Request"
2.06	2017/11/20	Update content: <ul style="list-style-type: none"> ● Section 5.1 "Common Commands" : HTS
2.07	2018/03/09	Added content: <ul style="list-style-type: none"> ● Section 5.1 "Common Commands" : GT3, SHD ● Section 5.2 "Common Response Events" : VT3, SCN ● Section 5.10 "MQTT" Update content: <ul style="list-style-type: none"> ● Section 5.1 "Common Commands" : DNS ● Section 5.3 "Common value (STC, GTC)" : SSL certificate option for HTTPS ● Section 5.8 " Update Firmware Commands" ● Section 5.9 "Data Transmission" : queue size ● Section 6.1 "Common Error Codes" ● Section 6.2 "Socket Error Codes"

- | | | |
|--|--|---|
| | | <ul style="list-style-type: none">● Chapter 9 : No.12● Chapter 10 : No.3● Appendix B : Common value (STC, GTC)● Appendix C |
|--|--|---|

Copyright Information:

-TAIYO YUDEN CO., LTD. WLAN Embedded Specification Documentation-

TAIYO YUDEN Co., Ltd. lawfully has copyrights and other rights to the Embedded Software. Except as otherwise expressly provided herein, you are not permitted to disclose or offer the Embedded Software, either wholly or partly, to any third party (including uploading to your company or third party (ies)'s web sites and downloading by third parties from such sites), nor to copy, revise, reverse engineer, upgrade, make specification change, or alienate the Embedded Software.

You are requested to fully check and confirm the following by the start of mass production, although TAIYO YUDEN Co., Ltd. sufficiently inspects or verifies quality of the Embedded Software.

- (1) No bug, defect or other failure is included in the Embedded Software
- (2) No bug, defect or other failure arising from installation of the Module into your product
- (3) Software fully meets your intended use

Copyright Year 2014-

Firmware Version is 2.07.04 (Build4.0.r3.1)

There is a possibility of changing a software specification.

Contents

1. OVERVIEW	8
2. PIN CONFIGURATION.....	9
2.1. UART	9
2.2. GPIO	9
2.2.1. <i>Force initialization</i>	9
2.2.2. <i>Labtool</i>	9
3. CONTROL COMMAND SYNTAX.....	10
4. DATA FORMAT	11
4.1. TCP.....	11
4.2. UDP	11
5. COMMAND AND EVENT LIST.....	12
5.1 COMMON COMMANDS.....	12
5.2 COMMON RESPONSE EVENTS	22
5.3 COMMON VALUE (STC, GTC)	27
5.4 INFRASTRUCTURE CONTROL COMMANDS.....	29
5.5 INFRASTRUCTURE RESPONSE EVENTS	31
5.6 PROFILE TABLE (STI, GTI, STU, GTU)	34
5.7 MICRO-AP CONTROL COMMANDS.....	36
5.8 UPDATE FIRMWARE COMMANDS	37
5.9 DATA TRANSMISSION.....	38
5.10 MQTT	39
5.10.1 <i>Command</i>	39
5.10.2 <i>Response</i>	39
5.10.3 <i>Command parameters</i>	40
5.10.4 <i>MQTT Error Codes</i>	43
6 ERROR CODE.....	45
6.1 COMMON ERROR CODES	45
6.2 SOCKET ERROR CODES.....	47
7 FATAL ERROR	51
8 MESSAGE SEQUENCE CHART	52
8.1 SCAN AND SCAN RESULT DETAIL.....	52
8.2 CONNECT	53
8.3 SOCKET INTERFACE USAGE (TCP)	54
8.4 SOCKET INTERFACE USAGE (UDP).....	55
8.5 WPS.....	56
8.5.1 <i>Infrastructure mode (WPS Enrollee)</i>	56
8.5.2 <i>uAP mode (WPS Registrar)</i>	56
8.6 HTTPREQUEST	57
8.6.1 <i>GET</i>	57
8.6.2 <i>POST</i>	57
8.6.3 <i>PUT</i>	57
8.6.4 <i>DELETE</i>	57
8.7 WEB CONFIGURATION	58

9 NOTE..... 59

10 KNOWN ISSUES 60

APPENDIX A. 61

APPENDIX B. 62

APPENDIX C. 64

APPENDIX D. 66

APPENDIX E. 67

1. Overview

This specification is for TAIYO YUDEN Standard Application for WLAN (referred to as TY's App).

Target applications are POS, Handy Terminal, Telemetry, FA, etc.

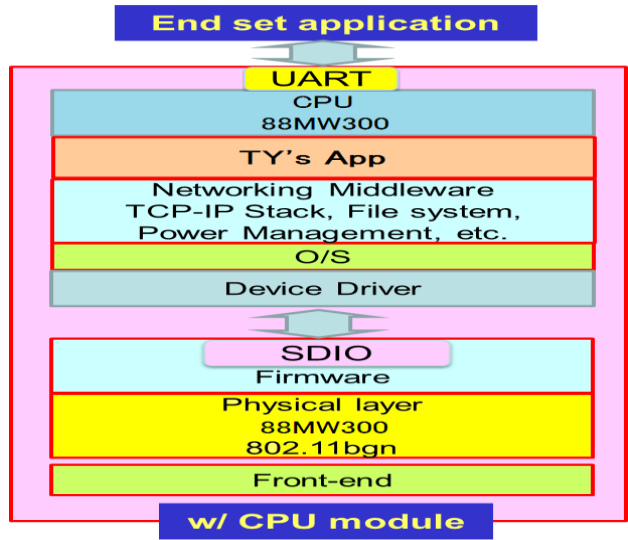

Air conditioner

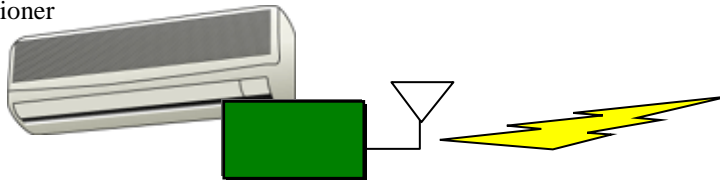

WLAN Embedded Module (Station)

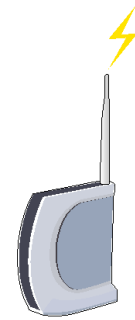

Access Point

Printer

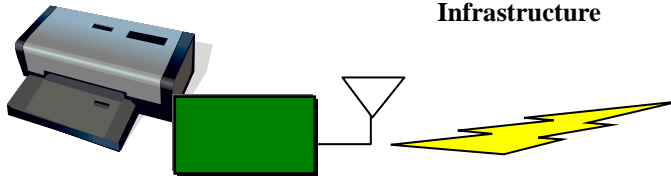

Infrastructure

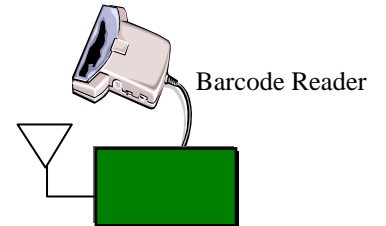

Barcode Reader



Smart Phone (Station)

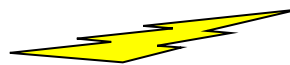

micro-AP

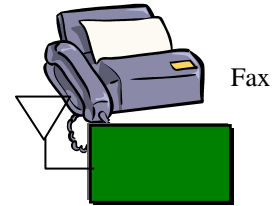

Fax

micro-AP (Infrastructure)



Smart Phone (Station)

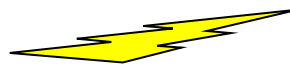

Usage Model

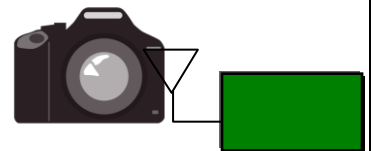

DSC (micro-AP)

2. PIN configuration

2.1. UART

Port : UART1

Baud rate : 115200 bps (default)

Parity : none

Stop bit : 1

Flow control : hardware

Baud rate can be configured by STC command.

See section 5.3 for detail.

2.2. GPIO

2.2.1. Force initialization

PIN : I2C0_SDA (GPIO_4)

Setting : input, pull-up

In case Low input to this pin at startup, format and initialize user data area at startup.

2.2.2. Labtool

PIN : I2C0_SCL (GPIO_5)

Setting : input, pull-up

In case Low input to this pin at startup, Start as Labtool mode that is RF calibration and testing tool.

In Labtool mode, the following message is output at startup (UART1 baud rate is fixed 115200 bps).

<CR><LF>MFG Ver. 2.07.04<CR><LF>

In Normal mode, the following message is output at startup.

<CR><LF>Ver. 2.07.04<CR><LF>

*** Please contact TAIYO YUDEN when you use Labtool.**

3. Control Command Syntax

Control commands which the host sends are based on character strings that start with “W”(ASCII code: 0x57, 87 decimal), and that end with <CR><LF> (ASCII code: 0x0D 0x0A) (decimal values 13, 10).

Response event which host receives are started with <CR><LF> and ended <CR><LF>. Please note that this specification / application does not allow for multiple commands to be sent to the host. The application is not responsible for parsing of packets / command sequences.

Command Mode – Control Command:

“W”{*command characters*}[*Parameter1Parameter2:: Parameter(N)*]<CR><LF>

Response Event:

<CR><LF>{*command characters*}[*Parameter1,Parameter2,::Parameter(N)*]<CR><LF>

4. Data Format

4.1. TCP

To transmit TCP data, the data must be wrapped with STX(0x02), CH and ETX(0x03).

0x03 (ETX) and 0x1b (ESC) inside the data cannot be transmitted without escaping them.

To escape a character you must precede it by the ESC(0x1b).

The character right after ESC is interpreted as a data byte.

The incoming data is delivered in the same format.

<STX><CH><data : up to 1460byte><ETX>

For instance

Data: 0x41, 0x03, 0x41, 0x1b, 0x41

CH: 1

Data			0x41	0x03		0x41	0x1b		0x41	
Format	STX	CH	0x41	ESC	0x03	0x41	ESC	0x1b	0x41	ETX
Binary	0x02	0x01	0x41	0x1b	0x03	0x41	0x1b	0x1b	0x41	0x03

4.2. UDP

To transmit UDP data, in addition to STX, CH and ETX, the destination IP address and Port is required.

The data section must be escaped in the same manner.

The incoming data is delivered in the same format.

IP address and Port are those of the source(sender).

<STX><CH><IP Address : 4byte><Port : 2byte><data : up to 1460byte><ETX>

For instance

IP Address: 192.168.11.5

Port: 3000

Format	STX	CH	IP Address				Port		data	ETX
Binary	0x02	0x01	0xc0	0xa8	0x0b	0x05	0x0b	0xb8	...	0x03

5. Command and Event List

5.1 Common Commands

Command Character	Function	Parameter	Response
Configuration			
STC	Set common setting value <i>For instance</i> <i>WSTC0100</i> <i>No.: 01 (UART baud rate)</i> <i>Value: 00</i>	<u>Parameter 0:</u> Item No. Refer 5.3 <u>Parameter 1:</u> Value Refer 5.3	Successful: ACK Failed: NAK##
GTC	Get common setting value <i>For instance</i> <i>WGTC01</i> <i>No.: 01 (UART baud rate)</i>	<u>Parameter:</u> Item No. Refer 5.3	Successful: Value Failed: NAK##
GT1	Get firmware version		Success: VT1 Failed: NAK##
GT2	Get a MAC address		Success: VT2 Failed: NAK##
GT3	Get Wi-Fi firmware version		Success: VT3 Failed: NAK##
DPS	Turn on/off deep sleep power save of wlan chip * Only wlan chip enters deep sleep mode and it does not affect MCU. * Available when disconnect status, otherwise return NAK.	<u>Parameter:</u> on/off '1': ON '0': OFF	Successful: ACK Failed: NAK##

SBY	<p>Put the module into standby mode.</p> <p>The module wakes up automatically after the timer has expired or when the gpio pin is asserted.</p> <p>Wakeup: WAKE_UP0 (GPIO_22) WAKE_UP1 (GPIO_23)</p> <p>* Only MCU enters low power mode (PM2) and it does not affect wlan chip.</p> <p>* Any command can't be processed in this mode.</p> <p>* The module also wakes up by the data from AP when the module is connected to AP with IEEE power save enabled and micro-AP mode is stopped.</p>	<p><u>Parameter:</u></p> <p>None : wakeup by GPIO '0' : wakeup by GPIO '1' - '172800000' : wakeup by RTC (milliseconds) or GPIO</p> <p>Min: 1 millisecond Max: 48 hour</p>	<p>Successful:</p> <p>ACK : standby WUP : wakeup</p> <p>Failed: NAK##</p>
RST	Soft reset		<p>Successful: ACK</p> <p>Failed: NAK##</p>
STT	<p>Set the time</p> <p><i>For instance</i></p> <p><i>WSTT0time.google.com</i></p> <p><i>NTP</i></p> <p><i>WSTT11420113600</i></p> <p><i>POSIX time (1420113600=2015/01/01 12:00:00)</i></p> <p><i>WSTT220150101120000</i></p> <p><i>Normal in UTC (Coordinated Universal Time)</i> <i>(2015/01/01 12:00:00)</i></p> <p>* The time is reset to 1970/01/01 00:00:00 after Power OFF.</p> <p>* Network access should be available for NTP.</p> <p>* NTP client uses following paramters.</p> <p>Leap Indicator : 00 (no warning) Version Number : 011 (version 3) Mode : 011 (client) others : all 0</p>	<p><u>Parameter 0:</u></p> <p>Format</p> <p>0 : NTP 1 : POSIX time 2 : Normal</p> <p><u>Parameter 1:</u></p> <p>[NTP] Host name (Max length 255)</p> <p>[POSIX time] The number of seconds that have elapsed since 00:00:00, 1 January 1970.</p> <p>[Normal] The time in the following format. 20150101120000 means "2015/01/01 12:00:00"</p>	<p>Successful: ACK</p> <p>Failed: NAK##</p>

GTT	Get the time <i>For instance</i> WGTT1 1420113600 <i>POSIX time (1420113600=2015/01/01 12:00:00)</i> WGTT2 2015/01/01 12:00:00 <i>Normal in UTC (Coordinated Universal Time)</i>	<u>Parameter:</u> format 1 : POSIX time 2 : Normal	Successful: Current module time in the specified format. Failed: NAK##
SCT	Set Certificate <i>For instance</i> WSCT1-----BEGIN CERTIFICATE-----<LF>M... 5Tynh+dXIVtx6quTx8itc2VrbqzPmrC3p/<LF> -----END CERTIFICATE-----<LF><CR><LF> <i>Set certificate in Index 1</i> WSCT2 <i>Erase Index 2</i> * <i>input format</i> - Max length of one line is 64. - Line feed code must be <LF>. - Command termination is <CR><LF>.	<u>Parameter 0:</u> Index ‘1’ ~ ‘5’ <u>Parameter 1:</u> Certificate in PEM format If parameter 1 is omitted, erase the data. (Max length 3072)	Successful: ACK Failed: NAK##
GCT	Get Certificate	<u>Parameter:</u> Index ‘1’ ~ ‘5’	Successful: Certificate in PEM format. Failed: NAK##

ERS	<p>Erase Profile and Setting of STC command</p> <p><i>For instance</i></p> <p>WERS</p> <p><i>all Profiles and Settings of STC command</i></p> <p>WERS01</p> <p><i>micro-AP Profile index : 1</i></p> <p>WERS11</p> <p><i>Infrastructure Profile index : 1</i></p> <p>WERS10</p> <p><i>Infrastructure WPS Profile</i></p> <p>WERS21</p> <p><i>Certificate index : 1</i></p>	<p>Optional</p> <p>If a parameter is omitted, all Profiles and Settings of STC command except UART baud rate will be erased, and then the module will be automatically rebooted.</p> <p><u>Parameter 0:</u></p> <p>'0' : micro-AP profile '1' : Infrastructure profile '2' : Certificate</p> <p><u>Parameter 1:</u></p> <p>'0' ~ '4' : Profile index In micro-AP, only '1' is available here.</p> <p>'1' ~ '5' : Certificate index</p>	<p>Successful: ACK</p> <p>Failed: NAK##</p>
SRN	<p>Setting Reflection Nortification</p> <p>The host notifies WLAN module of the acknowledgment of SCN event receipt.</p>		
STG	<p>Set Generic setting value</p> <p><i>For instance</i></p> <p>WSTG014</p> <p><i>Index : 01</i></p> <p><i>Value : 4</i></p>	<p><u>Parameter0:</u></p> <p>Index. '01' ~ '64'</p> <p><u>Parameter1:</u></p> <p>Value</p>	<p>Successful: ACK</p> <p>Failed: NAK##</p>
GTG	<p>Get Generic Setting Value</p> <p><i>For instance</i></p> <p>WGTG01</p> <p>4</p>	<p><u>Parameter0:</u></p> <p>Index. '01' ~ '64'</p>	<p>Successful: Value</p> <p>Failed: NAK##</p>

Link Control			
GCN	Retrieve the system's current infrastructure network configuration		Successful: CFG Failed: NAK##
SOC	Create Socket <i>For instance</i> <i>WSOC0192.168.011.0033000</i> <i>Socket limitation in number</i> <i>Total : 12</i> <i>TCP : 8</i> <i>UDP : 10</i>	<u>Parameter 0:</u> TCP/UDP '0' : TCP '1' : UDP <u>Parameter 1:</u> IP Address TCP: Server address UDP: 000.000.000.000 <u>Parameter 2:</u> Port TCP: Server port UDP: Local port to bind (If set to 0, a socket will not be bounded to any port. Only TX data is available.)	Successful: SOK Failed: NAK##
SOS	Start TCP Server Listening Socket <i>Socket limitation in number</i> <i>Total : 12</i> <i>TCP : 8</i> <i>UDP : 10</i>	<u>Parameter 0:</u> Port	Successful: SOK Failed: NAK##, SNG
CSO	Close Socket	<u>Parameter 0:</u> Channel	Successful: SCL Failed: NAK##
GLS	Get Listening Socket Channel	<u>Parameter 0:</u> Port	Successful: LSC Failed: NAK##
GSI	Get Socket Information	<u>Parameter 0:</u> Channel	Successful: SOI Failed: NAK##
WPS	Start/Stop WPS Enrollee : when micro-AP is not started	<u>Parameter 0:</u> Start/Stop '1' : Start '0' : Stop	Successful: ACK, Enrollee: WEF, CON Registrar:

	<p>Registrar : when micro-AP is started with “USA” command</p> <p><i>For instance</i> WWPS1060 (Start, Timeout=60sec)</p>	<p><u>Parameter 1:</u> Timeout (Second, 010~999)</p> <p><u>Parameter 2:</u> PIN Code (To the button method if don't set the PIN CODE.)</p>	<p>WRF</p> <p>Failed: NAK##</p>
PNG	<p>ICMP Ping</p> <p><i>For instance</i> <u>command (default parameter)</u> WPNG0192.168.003.002<CR><LF></p> <p><u>response</u> <CR><LF> PING 192.168.3.2 (192.168.3.2) 56(84) bytes of data<CR><LF> <CR><LF> 64 bytes from 192.168.3.2: icmp_req=1 ttl=128 time=1 ms<CR><LF> <CR><LF> 64 bytes from 192.168.3.2: icmp_req=2 ttl=128 time=1 ms<CR><LF> <CR><LF> 64 bytes from 192.168.3.2: icmp_req=3 ttl=128 time=0 ms<CR><LF> <CR><LF> 64 bytes from 192.168.3.2: icmp_req=4 ttl=128 time=1 ms<CR><LF> <CR><LF> 64 bytes from 192.168.3.2: icmp_req=5 ttl=128 time=1 ms<CR><LF> <CR><LF> --- 192.168.3.1 ping statistics ---<CR><LF> <CR><LF> 5 packets transmitted, 5 received, 0% packet loss<CR><LF></p> <p><u>command (custom parameter)</u> WPNG1192.168.003.002030720001002<CR><LF></p> <p><i>Option : 1</i> <i>IP Address : 192.168.3.2</i> <i>Length : 3072 bytes</i> <i>Count : 10 times</i> <i>Timeout : 2 seconds</i></p>	<p><u>Parameter 0:</u> Option ‘0’: default ‘1’: custom</p> <p><u>Parameter 1:</u> IP Address DDD.DDD.DDD.DDD (Decimal)</p> <p>Below parameter is available when Parameter 0 = 1</p> <p><u>Parameter 2:</u> Length (byte) DDDDD (Decimal) default 00056 maximum 03072</p> <p><u>Parameter 3:</u> Count DDDDD (Decimal) default 00005 maximum 99999</p> <p><u>Parameter 4:</u> Timeout (second) DD (Decimal) default 02 maximum 99</p>	<p>Successful: Response</p> <p>Failed: NAK##</p>
DNS	Get IP Address of given host name	<u>Parameter:</u>	Successful: Value

	<p><i>For instance</i></p> <p><u>command</u></p> <p>WDNSwww.google.co.jp<CR><LF></p> <p>Host name : www.google.co.jp</p> <p><u>response</u></p> <p><CR><LF>174.125.235.215<CR><LF></p> <p><u>command</u></p> <p>WDNSyahoo.co.jp<CR><LF></p> <p>Host name : yahoo.co.jp</p> <p><u>response</u></p> <p><CR><LF> 183.079.135.206<CR><LF></p>	<p>Host name (Max length 255)</p>	<p>Failed: NAK##</p>
<p>TTC</p>	<p>ttcp (Test TCP)</p> <p>ttcp is a utility for measuring network throughput.</p> <p><i>For instance</i></p> <p><u>TCP TX</u></p> <p>WTTC01192.168.003.002050010102420000<CR><LF></p> <p>Protocol : TCP, Role : TX, IP Address : 192.168.3.2</p> <p>Port : 5001, Length : 1024, Number : 20000</p> <p><u>response</u></p> <p><CR><LF></p> <p>ttcp-t: connecting to server<CR><LF></p> <p><CR><LF></p> <p>ttcp-t: 20480000 bytes in 20876 ms = 7848 Kbit/sec +++<CR><LF></p> <p><CR><LF></p> <p>ttcp-t: 20000 I/O calls, msec/call = 1, calls/sec = 958<CR><LF></p> <p><u>TCP RX</u></p> <p>WTTC00000.000.000.00000000000000000000<CR><LF></p> <p>Protocol : TCP, Role : RX, IP Address : -</p> <p>Port : 5001, Length : 8192, Number : -</p> <p><u>response</u></p> <p><CR><LF></p> <p>ttcp-r: waiting for connection<CR><LF></p> <p><CR><LF></p> <p>ttcp-r: net_accept from 192.168.3.2<CR><LF></p> <p><CR><LF></p>	<p>If a parameter is omitted, stop ongoing ttcp execution.</p> <p><u>Parameter 0:</u></p> <p>Protocol</p> <p>'0': TCP</p> <p>'1': UDP</p> <p><u>Parameter 1:</u></p> <p>Role</p> <p>'0': RX</p> <p>'1': TX</p> <p><u>Parameter 2:</u></p> <p>IP Address</p> <p>DDD.DDD.DDD.DDD</p> <p>(Decimal)</p> <p>* ignored in RX role</p> <p><u>Parameter 3:</u></p> <p>Port</p> <p>DDDDD</p> <p>(Decimal)</p> <p>default: 05001</p> <p>(in case 00000)</p>	<p>Successful: Response</p> <p>Failed: NAK##</p>

	<pre> tcp-r: 20480000 bytes in 7646 ms = 21424 Kbit/sec +++<CR><LF> <CR><LF> tcp-r: 19630 I/O calls, msec/call = 0, calls/sec = 2567<CR><LF> UDP TX WTTC11192.168.003.002050010102420000<CR><LF> Protocol : UDP, Role : TX, IP Address : 192.168.3.2 Port : 5001, Length : 1024, Number : 20000 response <CR><LF> tcp-t: starting udp stream<CR><LF> <CR><LF> tcp-t: 5753856 bytes in 2024 ms = 22736 Kbit/sec +++<CR><LF> <CR><LF> tcp-t: 20002 I/O calls, msec/call = 0, calls/sec = 9882<CR><LF> UDP RX WTTC10000.000.000.00000000000000000000<CR><LF> Protocol : UDP, Role : RX, IP Address : - Port : 5001, Length : 8192, Number : - response <CR><LF> tcp-r: waiting for connection<CR><LF> <CR><LF> tcp-r: 20480000 bytes in 7388 ms = 22176 Kbit/sec +++<CR><LF> <CR><LF> tcp-r: 20002 I/O calls, msec/call = 0, calls/sec = 2707<CR><LF> Stop tcp WTTC<CR><LF> </pre>	<p><u>Parameter 4:</u> Length (byte) DDDDD (Decimal) default: 08192 (in case 00000) maximum: 99999</p> <p><u>Parameter 5:</u> Number DDDDD (Decimal) default: 4294967295 (in case 00000) maximum: 99999 * ignored in RX role</p>	
<p>SHD</p>	<p>Set HTTP custom header</p> <p><i>For instance</i></p> <p>WSHD01Content-Type:text/html</p> <p>Index : 01</p> <p>Name : "Content-Type"</p> <p>Value : "text/html"</p>	<p><u>Parameter 0:</u> Index. '01' ~ '15'</p> <p><u>Parameter 1:</u> Name Index'1'~'12' : Max 30characters Index'13'~'15' : Max 50characters</p>	<p>Successful: ACK</p> <p>Failed: NAK##</p>

		<p>The following characters is unaccepted :</p> <p>"(),/;:<=>?@[¥]{}</p> <p>(Put a ‘.’ in the edge of the Name)</p> <p><u>Parameter 2:</u></p> <p>Value</p> <p>Index‘1’~‘12’ : Max 50characters</p> <p>Index‘13’~‘14’ : Max 105characters</p> <p>Index‘11’~‘15’ : Max 600characters</p> <p>Printable US-ASCII</p>	
GHD	<p>Get HTTP custom header</p> <p><i>For instance</i></p> <p><i>WGHD01</i></p> <p><i>Content-Type:text/html</i></p>	<p><u>Parameter:</u></p> <p>Index.</p> <p>‘01’ ~ ‘15’</p>	<p>Successful: Value</p> <p>Failed: NAK##</p>
HTT	<p>Send HTTP request</p> <p><i>For instance</i></p> <p><i>WHTT10003http/www.test.org/index.html*abc=1234&def=5678</i></p> <p><i>Method : POST</i></p> <p><i>Use HTTP custom Header : Index1 , Index2</i></p>	<p><u>Parameter0:</u></p> <p>Method.</p> <p>0 : GET</p> <p>1 : POST</p> <p>2 : PUT</p> <p>3 : DELETE</p> <p><u>Parameter1:</u></p> <p>Use HTTP Custom Header.</p> <p>Bit0 : Index1</p> <p>Bit1 : Index2</p> <p>...</p> <p>Bit13 : Index14</p> <p>Bit14 : Index15</p> <p>The same index of SHD and GHD command/</p> <p><u>Parameter2:</u></p> <p>URI.</p>	<p>Successful: RCT</p> <p>Failed: NAK##</p> <p>* NAK31 is followed by RCT response.</p>

		(Put a '*' in the edge of the URI.) (Max length 1024 without '*') <u>Parameter3:</u> Content. (Up to 3072byte, ASCII data)	
HTS	HTTP Server Startup <i>For instance</i> <i>WHTS2</i> <i>HTTP Server Start</i> Only one client can connect at the same time. About Firmware Update feature, See Section 5.8 "Update Firmware Commands" for details.	<u>Parameter0:</u> Start/Stop 0 : Stop 1 : Start (HTTP Server for Firmware Update) 2 : Start (HTTP Server)	Successful: ACK Failed: NAK##

5.2 Common Response Events

Response Events	Function	Parameters
ACK	Successful	
NAK##	Failed	Failed Reason – See Error Chapter 6. For further details.
FTL##	Fatal Error	Error Reason – See Error Chapter 7. For further details.
VT1	Firmware Version <i>For instance</i> VT12.07.04(Build4.0.r3.1)	<u>Parameter:</u> Version
VT2	MAC address <i>For instance</i> VT2002258ABC659	<u>Parameter:</u> MAC address
VT3	Wi-Fi firmware <i>For instance</i> VT314.76.36.p126	<u>Parameter:</u> Wi-Fi firmware version
RCS	Handle <i>For instance</i> RCS01 Handle : 01	<u>Parameter 0:</u> Handle
RCT	Content Data <i>For instance</i> RCTXXXXXXXXXX	<u>Parameter 0:</u> Content Data * When there is not Content data, it means termination. * <CR> in Content Data is removed. * If <LF> appears, current RCT response is terminated after <LF> (plus <CR><LF>) and further data is output as next RCT response.
CON	Connection successful <i>For instance</i> CON1,MOBILE AP-A CON0,123456789ABC	<u>Parameter 0:</u> Mode ‘0’ : micro-AP ‘1’ : Infrastructure [micro-AP] <u>Parameter 1:</u> MAC address

		<p>[Infrastructure]</p> <p><u>Parameter 1:</u></p> <p>SSID</p>
DCO	<p>Disconnect</p> <p>* In Infrastructure mode, Link Lost is notified when beacon is missed for 60 consecutive times. (beacon interval) * 60 millisecond</p> <p>* When "Auto connect flag" is OFF, Link Lost response delays 3 seconds in addition above.</p>	<p><u>Parameter 0:</u></p> <p>Mode</p> <p>‘0’ : micro-AP</p> <p>‘1’ : Infrastructure</p> <p>[micro-AP]</p> <p><u>Parameter 1:</u></p> <p>MAC address</p> <p>[Infrastructure]</p> <p><u>Parameter 1:</u></p> <p>Reason</p> <p>‘0’ : User Disconnect</p> <p>‘1’ : Link Lost</p> <p>‘2’ : Disconnected from AP side</p>
CFG	<p>Current network configuration</p> <p><i>For instance</i></p> <p><i>CFG</i></p> <p><i>0022581234,06,0,192.168.11.2,TAIYO AP</i></p>	<p><u>Parameter 0:</u></p> <p>BSSID</p> <p><u>Parameter 1:</u></p> <p>Channel</p> <p><u>Parameter 2:</u></p> <p>Security</p> <p>‘0’ : Not use security</p> <p>‘1’ : WEP with open key.</p> <p>‘2’ : WEP with shared key</p> <p>‘3’ : WPA or WPA/WPA2 with PSK mixed</p> <p>‘4’ : WPA2 with PSK</p> <p><u>Parameter 3:</u></p> <p>IP Address</p> <p><u>Parameter 4:</u></p> <p>SSID</p>
SOK	<p>Create socket successful</p>	<p><u>Parameter:0</u></p> <p>Channel</p>

		<p><u>Parameter 1:</u> '0' : TCP Client '1' : TCP Server (Listening) '2' : TCP Server (Accepted) '3' : UDP</p> <p><u>Parameter 2:</u> Local Port Return 0 in TCP Client</p> <p><u>Parameter 3:</u> Remote IP Return 0.0.0.0 in TCP Server (Listening) or UDP</p> <p><u>Parameter 4:</u> Remote Port Return 0 in TCP Server (Listening) or UDP</p>
SNG	Create socket failed	<p><u>Parameter 0:</u> Listen Channel</p> <p><u>Parameter 1:</u> Remote IP address</p>
DOK	Data send successful	
DNG	Data send failed	
SCL	Close socket successful	<p><u>Parameter:</u> Channel</p>
LSC	Listening Socket Channel	<p><u>Parameter:</u> Channel</p>
SOI	Socket Information	<p><u>Parameter 0:</u> '0' : TCP Client '1' : TCP Server (Listening) '2' : TCP Server (Accepted) '3' : UDP</p> <p><u>Parameter 1:</u> Local Port Return 0 in TCP Client</p> <p><u>Parameter 2:</u> Remote IP Return 0.0.0.0 in TCP Server (Listening) or UDP</p>

		<u>Parameter 3:</u> Remote Port Return 0 in TCP Server (Listening) or UDP
WUP	Wakeup	
WRF	WPS Registrar Finish	
WEF	WPS Enrollee Finish	
UBG	Server mode update begins	
UEN	Server mode update ends in success	
SCN	Setting Change Notification When any parameters of the module is changed through the web page, the module notifies the host of the changed items. <i>For instance</i> SCN0186148761B3315FA24D85313C5DE953F0 Initialization flag : False Profile : STA index 1 Updated items : Bit0-3 : 0x0 (Item No.1-4 are unchanged) Bit4-7 : 0xF (Item No.5-8 are changed) Bit8-11 : 0x3 (Item No.9 and 10 are changed. Item No.11 and 12 are unchanged.) Bit12-15 : 0x5 (Item No.13 and 15 are changed. Item No.14 and 16 are unchanged.) ... SCN10000000000000000000000000000000 Initialization flag : True	<u>Parameter0:</u> Initialization flag 0 : False 1 : True When "1" is set to Parameter0, - Parameter1 and Parameter2 are all 0. - In the module, default value is set to all parameters except UART baud rate. <u>Parameter1:</u> Profile index (STI/STU command) 0 : STA index 0 1 : STA index 1 2 : STA index 2 3 : STA index 3 4 : STA index 4 5 : UAP index 1 One profile can be updated at one time. Updated items is indicated in Parameter 2. <u>Parameter2:</u> Updated items (Hexadecimal Number in ASCII) Each bit value : 0 (unchanged) / 1 (changed) Bit 0-31 : Profile items (STI/STU command) Refer 5.6 From Item No.1 in order. Bit 0 : Item No.1 Bit 1 : Item No.2 ... Bit 32-39 : Common value (STC command) Refer 5.3

		<p>From Item No.1 in order.</p> <p>Bit 32 : Item No.1</p> <p>Bit 33 : Item No.2 ...</p> <p>Bit 40 : Current time (STT command)</p> <p>Bit 41 : User Certificate (SCT command Index1)</p> <p>Bit 42-47 : Unused</p> <p>Bit 48-63 : HTTP custom header (SHD command)</p> <p>Refer 5.1</p> <p>From Index 1 in order.</p> <p>Bit 48 : Index 1</p> <p>Bit 49 : Index 2 ...</p> <p>Bit 64-127 : Generic setting value (STG command)</p> <p>Refer 5.1</p> <p>From Index 1 in order.</p> <p>Bit 64 : Index 1</p> <p>Bit 65 : Index 2 ...</p>
--	--	--

5.3 Common value (STC, GTC)

No.	Item Name	
01	UART baud rate (bps)	<p>"00" - "11"</p> <p>00 : 115200 (default)</p> <p>01 : 9600</p> <p>02 : 19200</p> <p>03 : 38400</p> <p>04 : 57600</p> <p>05 : 115200</p> <p>06 : 230400</p> <p>07 : 250000</p> <p>08 : 500000</p> <p>09 : 1000000</p> <p>10 : 1500000</p> <p>11 : 2000000</p> <p>* Baud rate setting will be updated after reboot.</p>
02	Auto connect flag	<p>"00" / "01"</p> <p>00 : OFF (default)</p> <p>01 : ON</p> <p>In infrastructure mode, keep attempt to connect to Access Point until stop with IDC command.</p>
03	IEEE PS	<p>"00" / "01"</p> <p>00 : OFF (default)</p> <p>01 : ON</p> <p>IEEE power save enable / disable In infrastructure mode. While micro-AP is active, IEEE power save is force to be disabled.</p>

04	SSL certificate option for HTTPS	<p>"01" - "03"</p> <p>01 : pre-installed certificates only (default) 02 : user certificates only 03 : none (disable server verification)</p> <p>Set the certificate option for HTTPS connection in HTT command. See Appendix C for pre-installed certificates. User certificates can be set with SCT command.</p>
05	Energy Detection for ETSI R&TTE EN 300 328 adaptivity requirement	<p>"00" / "01"</p> <p>00 : OFF (default) 01 : ON</p> <p>* Energy Detection setting will be updated after reboot.</p>
06	Listen Interval for IEEE power save mode (Common value No.03)	<p>"01" - "49"</p> <p>01 : receive all beacon (default) 02 : receive every 2nd beacon ... 49 : receive every 49th beacon</p> <p>* The configured listen interval will be used in subsequent association attempt. * Actual listen interval set will be a multiple of DTIM closest to the value.</p>

5.4 Infrastructure Control Commands

Command Character	Function	Parameter	Response
Link Control			
ISC	Scan for wireless networks * up to 30 th Access Point		Successful: SCR, ACK (ACK is termination) Failed: NAK##
ISD	Request a scan result detail. <i>For instance</i> <i>WISD02 (Index = 2)</i>	<u>Parameter:</u> Scan Index	Successful: SCD Failed: NAK##
ICO	Connect to a network <i>For instance</i> <i>WICO1</i> Before this command is issued, List Index corresponding to AP information must be set using STI command.	<u>Parameter:</u> List Index '0' - '4' '0' : Configured by WPS '1' - '4' : Profile Index	Successful: CON Failed: NAK##
IDC	Disconnect from the current network		Successful: ACK : command accepted DCO : disconnected Failed: NAK##

Configuration			
STI	Set infrastructure configuration. <i>For instance</i> WSTI101ACCESS POINTA <i>List: 1</i> <i>No.: 01 (SSID)</i> <i>Value: ACCESS POINTA</i> WSTI10312345678 <i>List: 1</i> <i>No.: 03 (PSK)</i> <i>Value: 12345678</i>	<u>Parameter 0</u> List Index “1” ~ “4” <u>Parameter 1</u> Item No. “01” ~ “99” Refer 5.6 <u>Parameter 2</u> Value Refer 5.6	Successful: ACK Failed: NAK##
GTI	Get infrastructure configuration <i>For instance</i> WGTI101 <i>List: 1</i> <i>No.: 01 (SSID)</i>	<u>Parameter 0</u> List Index “0” ~ “4” ‘0’ : configured by WPS Enrollee ‘1’ – ‘4’ : Profile Index <u>Parameter 1</u> Item No. “01” ~ “99” Refer 5.6	Successful: Value Failed: NAK##
GSS	Get current RSSI and Signal to Noise ratio <i>For instance</i> WGSS -46,51 <i>RSSI : -46 (decimal value)</i> <i>SNR : 51 (decimal value)</i> * available only when connected to AP	/	Successful: Value1 (RSSI), Value2 (SNR) Failed: NAK##

5.5 Infrastructure Response Events

Response Events	Function	Parameters
SCR	List of Scan results <i>For instance</i> <i>SCR01,0022581234AB,TAIYO AP</i>	<u>Parameter 0:</u> Scan Index “01” ~ “30” (It is added in turn.) <u>Parameter 1:</u> BSSID <u>Parameter 2:</u> SSID

Parameter 9:

Rssi

Parameter 10:

SSID

5.6 Profile Table (STI, GTI, STU, GTU)

No.	Item Name	
01	ssid	Max 32characters
02	security type	'0' : No security '1' : WEP with open key. '2' : WEP with shared key '3' : WPA/WPA2 with PSK mixed '4' : WPA2 with PSK In STU/GTU, only '0' or '4' can be accepted.
03	security key	Max 64 characters <i>WEP : ASCII (5 or 13byte) / HEX (10 or 26byte)</i> <i>WPA/WPA2 : ASCII</i>
04	addr_type '0' in STU/GTU	'0' : Static '1' : DHCP
05	IP address (static addr type)	"XXX.XXX.XXX.XXX"
06	subnet mask (static addr type)	"XXX.XXX.XXX.XXX"
07	default gateway (static addr type)	"XXX.XXX.XXX.XXX"
08	primary DNS server (static addr type)	"XXX.XXX.XXX.XXX"
09	secondary DNS server (static addr type)	"XXX.XXX.XXX.XXX"
10	bssid (option)	"000000000000"~"FFFFFFFFFFFF"
11	channel (option)	"00" ~ "11" 00 in Infrastructure : scan AP in all 1-11 channel. 00 in micro-AP : automatically select the least congested channel.

12	bssid specific (option)	'0' : Connect to any network whose SSID matches. '1' : Not connect to any other network with the same SSID unless the BSSID matches.
13	channel specific (option)	'0' : available channel '1' : specific channel

STU/GTU only

20	MAC Address filtering	'0' : Disable '1' : Enable
21	Allowed MAC Address 1	"000000000000"~"FFFFFFFFFFFF" Ignored when "FFFFFFFFFFFF" is set.
22	Allowed MAC Address 2	"000000000000"~"FFFFFFFFFFFF" Ignored when "FFFFFFFFFFFF" is set.
23	Allowed MAC Address 3	"000000000000"~"FFFFFFFFFFFF" Ignored when "FFFFFFFFFFFF" is set.
24	Allowed MAC Address 4	"000000000000"~"FFFFFFFFFFFF" Ignored when "FFFFFFFFFFFF" is set.
25	Allowed MAC Address 5	"000000000000"~"FFFFFFFFFFFF" Ignored when "FFFFFFFFFFFF" is set.

5.7 micro-AP Control Commands

Command Character	Function	Parameter	Response
Link Control			
USA	Start / Stop uAP network * uAP Stop command will also stop DHCP server.	<u>Parameter:</u> Start / Stop '1' : Start '0' : Stop	Successful: ACK Failed: NAK##
UDC	Start / Stop DHCP server * This command can be called after micro-AP is started with USA command	<u>Parameter:</u> Start / Stop '1' : Start '0' : Stop	Successful: ACK Failed: NAK##
Configuration			
STU	Set micro-AP (uAP) configuration. <i>For instance</i> <i>WSTU101UAP Module</i> <i>List: 1</i> <i>No.: 01 (SSID)</i> <i>Value: UAP Module</i> <i>WSTU10312345678</i> <i>List: 1</i> <i>No.: 03 (PSK)</i> <i>Value: 12345678</i>	<u>Parameter 0</u> List Index '1' : List 1 <u>Parameter 1</u> Item No. "01" ~ "99" Refer 5.6 <u>Parameter 2</u> Value Refer 5.6	Successful: ACK Failed: NAK##
GTU	Get micro-AP (uAP) configuration <i>For instance</i> <i>WGTU101</i> <i>List: 1</i> <i>No.: 01 (SSID)</i>	<u>Parameter 0</u> List Index '1' : List 1 <u>Parameter 1</u> Item No. Refer 5.6	Successful: Value Failed: NAK##

5.8 Update Firmware Commands

Command Character	Function	Parameter	Response
Link Control			
UFW	Update Firmware in HTTP Client mode <i>For instance</i> WUFW1 http://set-your-host/fw.bin <i>Kind: 1 (Module Firmware)</i> <i>URI: http://set-your-host/fw.bin</i> WUFW2 http://set-your-host/wifi.xz <i>Kind: 2 (Wi-Fi Firmware)</i> <i>URI: http://set-your-host/wifi.xz</i> About 10 seconds after "UEN" response, the module reboots and loads the new firmware.	<u>Parameter 0:</u> Kind '1' : Module Firmware '2' : Wi-Fi Firmware '3' : FTFS <u>Parameter 1:</u> Firmware file URI (Max length 1024)	Successful: ACK : Server Start/Stop UBG : Update Begin UEN : Update End Failed: NAK##
HTS	Update Firmware in HTTP Server mode About 10 seconds after "UEN" response, the module reboots and loads the new firmware.	<u>Parameter 0:</u> Start/Stop 0 : Stop HTTP Server 1 : Start HTTP Server for Firmware Update	Successful: ACK : Server Start/Stop UBG : Update Begin UEN : Update End Failed: NAK##

In server mode, use the form in <http://<TY's App's IP Address>/index.html> or "curl" command as follows:

Module Firmware

```
curl -F "filename=@/tmp/fw.bin" 192.168.100.100/sys/firmware
```

Wi-Fi Firmware

```
curl -F "filename=@/tmp/wifi.xz" 192.168.100.100/sys/wifi-firmware
```

FTFS

```
curl -F "filename=@/tmp/new.ftfs" 192.168.100.100/sys/filesystem
```

Important notes

- Do not turn the power off while updating firmware.
- Before this command, IP Address should be assigned by ICO or USA command.
- Do not use the firmware image which is not released by our company.

5.9 Data Transmission

Command Character	Function	Parameter	Response
Data Transmission			
Refer to chapter4	<p>Transmit data with a socket</p> <p>TCP: <STX><CH><data><ETX></p> <p>UDP: <STX><CH><IPAddress><Port><data><ETX></p> <p>A transmission data size is limited to 1460byte or smaller.</p> <p>If you transmit a data over 1460byte, divide so that each data is within the limitation.</p> <p>If you need flow control for every packet, send next data after DOK of previous data.</p> <p>When you send data continuously, you can go on adding the data to the queue (size is 2) before DOK is respond until NAK23 (full queue) response.</p> <p>* Maximum TCP retransmission timeout is about 40 minutes.</p> <p>Therefore it is possible that the response of DOK or DNG delays up to 40 minutes.</p>		<p>Successful: ACK, DOK</p> <p>Failed: NAK##, DNG</p> <p>ACK : the data is queued DOK : the data is sent</p>
BST	<p>Burst transmission mode</p> <p>When enabled, it omits ACK or DOK response from above transmission command.</p> <p>However, negative acknowledgement (NAK, DNG) is available in any mode.</p> <p>The setting is dynamically reflected and isn't saved to the flash.</p>	<p><u>Parameter:</u></p> <p>on/off</p> <p>'0' : OFF (default) both ACK and DOK</p> <p>'1' : output only ACK</p> <p>'2' : output only DOK</p> <p>'3' : no output</p>	<p>Successful: ACK</p> <p>Failed: NAK##</p>

5.10 MQTT

5.10.1 Command

Command Character	Function	Parameter	Response
Data Transmission			
MQT	MQTT	<u>Parameter 0:</u> Operation ‘0’ : Set the configuration ‘1’ : Get the configuration ‘2’ : Connect to the broker ‘3’ : Subscribe ‘4’ : Publish ‘5’ : Get (AWS IoT Thing Shadow only) ‘6’ : Delete (AWS IoT Thing Shadow only) Refer 5.10.3 for the parameters of each operation.	Refer 5.10.3 for the Responses of each operation.

5.10.2 Response

Response Events	Function	Parameters
ACK	Successful	
NAK##	Failed	Failed Reason – See 5.10.4 For further details.
RCM	MQTT response	<u>Parameter 0:</u> (1byte) Operation – See 5.10.1 For further details. <u>Parameter 1:</u> (2byte) Error code – See 5.10.4 For further details. <u>Parameter 2:</u> Operation 3 (Subscribe) : 1-5 : Subscribe index Operation 5 (Get) : 0 The Others : Null <u>Parameter 3:</u> Operation 3, 5 : Data The Others : Null

5.10.3 Command parameters

Param 0	Param 1	Param 2	Param 3	Param 4	Param 5	Description	Response	
0	0	0	0	-		AWS IoT Thing Shadow	Successful: ACK	
			1			Normal MQTT		
		1	1024byte			MQTT broker endpoint		
		2	80byte			Client ID		
		3	3072byte PEM			root ca cert		
						device certificate (client cert)		
		4	3072byte PEM			device private key (client key)		
		5	3072byte PEM			Publish QoS 0		
						Publish QoS 1		
		6	0			Subscribe QoS 0		
	Subscribe QoS 1							
	7	0	Subscribe QoS 0					
			Subscribe QoS 1					
	1	1	1	0	-	90byte	device thing name	Failed: NAK##
				1	0-9 Primitive Type	90byte	Subscribe JSON key 1 *1	
				2		90byte	Subscribe JSON key 2 *1	
				3		90byte	Subscribe JSON key 3 *1	
				4		90byte	Subscribe JSON key 4 *1	
				5		90byte	Subscribe JSON key 5 *1	
	2	0		1	90byte	Subscribe topic No.1		
				2	90byte	Subscribe topic No.2		
				3	90byte	Subscribe topic No.3		
				4	90byte	Subscribe topic No.4		
				5	90byte	Subscribe topic No.5		
		1		0	-		CleanSession : false	
				1			CleanSession : true	
		2	32byte	username				
		3	32byte	password				
		4	16bit decimal	keep alive interval in second				
		5	0	will flag : 0				
				1			will flag : 1	
		6	0			retain flag (publish) : 0		

			1			retain flag (publish) : 1	
1	0	0	-		0: AWS IoT Thing Shadow	Successful: ACK Failed: NAK##	
		1			1: Normal MQTT		
		2			MQTT broker endpoint		
		3			Client ID		
		4			root ca cert		
		5			device certificate (client cert)		
		6			device private key (client key)		
		7			0: Publish QoS 0		
					1: Publish QoS 1		
					0: Subscribe QoS 0		
		1: Subscribe QoS 1					
	1	0	-		device thing name		
	2	0	1	-			Subscribe topic No.1 *2
			2				Subscribe topic No.2 *2
			3				Subscribe topic No.3 *2
			4				Subscribe topic No.4 *2
			5				Subscribe topic No.5 *2
		1	1	-			0: CleanSession : false
							1: CleanSession : true
			2				username
3			password				
4			keep alive interval in second				
5			0: will flag : 0				
			1: will flag : 1				
			0: retain flag (publish) : 0				
6			1: retain flag (publish) : 1				
2	0	-		Disconnect			
	1			Connect			
3	1	0	-		Unsubscribe topic No.1 (*1 / *2)		
		1			Subscribe topic No.1 (*1 / *2)		
	2	0			Unsubscribe topic No.2 (*1 / *2)		
		1			Subscribe topic No.2 (*1 / *2)		
	3	0	-		Unsubscribe topic No.3 (*1 / *2)		
		1			Subscribe topic No.3 (*1 / *2)		
	4	0			Unsubscribe topic No.4 (*1 / *2)		
		1			Subscribe topic No.4 (*1 / *2)		
	5	0			Unsubscribe topic No.5 (*1 / *2)		
		1			Subscribe topic No.5 (*1 / *2)		

4	0	90byte	-	Set Publish topic (Normal MQTT)	RCM
	1	1024byte		*2	
				Publish data	
5	-			Get (AWS only)	RCM
6	-			Delete (AWS only)	RCM

AWS IoT Shadow PING Interval (keep alive interval) : 600 seconds

5.10.4 MQTT Error Codes

#	Description
06	NETWORK_PHYSICAL_LAYER_CONNECTED
05	NETWORK_MANUALLY_DISCONNECTED
04	NETWORK_ATTEMPTING_RECONNECT
03	NETWORK_RECONNECTED
02	MQTT_NOTHING_TO_READ
01	MQTT_CONNACK_CONNECTION_ACCEPTED
00	AWS_SUCCESS
FF	AWS_FAILURE
FE	NULL_VALUE_ERROR
FD	TCP_CONNECTION_ERROR
FC	SSL_CONNECTION_ERROR
FB	TCP_SETUP_ERROR
FA	NETWORK_SSL_CONNECT_TIMEOUT_ERROR
F9	NETWORK_SSL_WRITE_ERROR
F8	NETWORK_SSL_INIT_ERROR
F7	NETWORK_SSL_CERT_ERROR
F6	NETWORK_SSL_WRITE_TIMEOUT_ERROR
F5	NETWORK_SSL_READ_TIMEOUT_ERROR
F4	NETWORK_SSL_READ_ERROR
F3	NETWORK_DISCONNECTED_ERROR
F2	NETWORK_RECONNECT_TIMED_OUT_ERROR
F1	NETWORK_ALREADY_CONNECTED_ERROR
F0	NETWORK_MBEDTLS_ERR_CTR_DRBG_ENTROPY_SOURCE_FAILED
EF	NETWORK_SSL_UNKNOWN_ERROR
EE	NETWORK_PHYSICAL_LAYER_DISCONNECTED
ED	NETWORK_X509_ROOT_CERT_PARSE_ERROR
EC	NETWORK_X509_DEVICE_CERT_PARSE_ERROR
EB	NETWORK_PK_PRIVATE_KEY_PARSE_ERROR
EA	NETWORK_ERR_NET_SOCKET_FAILED
E9	NETWORK_ERR_NET_UNKNOWN_HOST
E8	NETWORK_ERR_NET_CONNECT_FAILED
E7	NETWORK_SSL_NOTHING_TO_READ
E6	MQTT_CONNECTION_ERROR
E5	MQTT_CONNECT_TIMEOUT_ERROR
E4	MQTT_REQUEST_TIMEOUT_ERROR
E3	MQTT_UNEXPECTED_CLIENT_STATE_ERROR

E2	MQTT_CLIENT_NOT_IDLE_ERROR
E1	MQTT_RX_MESSAGE_PACKET_TYPE_INVALID_ERROR
E0	MQTT_RX_BUFFER_TOO_SHORT_ERROR
DF	MQTT_TX_BUFFER_TOO_SHORT_ERROR
DE	MQTT_MAX_SUBSCRIPTIONS_REACHED_ERROR
DD	MQTT_DECODE_REMAINING_LENGTH_ERROR
DC	MQTT_CONNACK_UNKNOWN_ERROR
DB	MQTT_CONNACK_UNACCEPTABLE_PROTOCOL_VERSION_ERROR
DA	MQTT_CONNACK_IDENTIFIER_REJECTED_ERROR
D9	MQTT_CONNACK_SERVER_UNAVAILABLE_ERROR
D8	MQTT_CONNACK_BAD_USERDATA_ERROR
D7	MQTT_CONNACK_NOT_AUTHORIZED_ERROR
D6	JSON_PARSE_ERROR
D5	SHADOW_WAIT_FOR_PUBLISH
D4	SHADOW_JSON_BUFFER_TRUNCATED
D3	SHADOW_JSON_ERROR
D2	MUTEX_INIT_ERROR
D1	MUTEX_LOCK_ERROR
D0	MUTEX_UNLOCK_ERROR
CF	MUTEX_DESTROY_ERROR

6 Error Code

6.1 Common Error Codes

#	Error Name	Program Logic Cause	Action taken by host
FF	System Error	There is the possibility that the hardware is out of order.	Please inquire Taiyo Yuden.
00	Command Not Recognized	It confirms whether or not the command is correct.	Send the command once again.
01	Bad Parameter	It confirms whether or not the parameter is correct.	Send the command once again.
04	Connection Error	General connection error	Check parameter and retry. Reconnect or reboot.
05	Profile Error	UAP / ICO command is called with invalid profile setting.	Set micro-AP / Infrastructure profile
06	WPS running Error	Input commands while WPS is running.	Wait or stop WPS.
07	FlashRom Access Error	It failed in FlashROM access of STC / SHD / STI / STU / SCT / GTC / GHD / GTI / GTU / GCT command.	Please inquire Taiyo Yuden.
10	Network Not Found	Access Point is not exist.	Check Access Point setting.
11	Authentication Failed	Authentication error occurs in association to Access Point.	Check parameter and retry.
12	DHCP Failed	IP address is not assigned after association to Access Point.	Check Access Point setting.
14	Other Infrastructure Connection error	Other error occurs in connection to Access Point.	Check Access Point setting.
15	Infrastructure is connected	ICO / WPS command is called while infrastructure is connected.	Disconnect infrastructure with IDC command.
16	Firmware update Failed	It failed in Firmware update.	Check if firmware file is valid and the command parameters.
20	TCP socket full	Create TCP socket over the limit	Close socket.
21	UDP socket full	Create UDP socket over the limit	Close socket.
22	Socket full	Create socket over the limit	Close socket.
23	Socket TX queue full	Socket TX queue is full	Wait until the queued data is sent.

30	HTTP connection error	Can not access HTTP server	Check WLAN connection and HTTP address. In HTTPS, check whether the server's certificate is installed.
31	HTTP status code Error	HTTP status code is not 200 (OK). Status code will be added after a comma. For instance NAK31,301 NAK31,404	Check HTTP status code.
32	Invalid User certificates	There is one or more invalid user certificates.	Check User certificates.
33	HTTP Header Invalid	Cannot add HTTP header	Check HTTP Custom Header Setting
34	HTTP Server is running	HTTP Server is running and SSL certificate option for HTTPS is pre-installed certificates.	Stop HTTP Server or Change SSL certificate option for HTTPS
35	WEB is updating internal setting values.	Internal setting values are being updated by Request from WEB.	Send the command once again.

6.2 Socket Error Codes

51	EPERM	Not owner	
52	ENOENT	No such file or directory	
53	ESRCH	No such process	
54	EINTR	Interrupted system call	
55	EIO	I/O error	
56	ENXIO	No such device or address	
57	E2BIG	Arg list too long	
58	ENOEXEC	Exec format error	
59	EBADF	Bad file number	
5A	ECHILD	No children	
5B	EAGAIN EWOULDBLOCK	No more processes	
5C	ENOMEM	Not enough space	
5D	EACCES	Permission denied	
5E	EFAULT	Bad address	
5F	ENOTBLK	Block device required	
60	EBUSY	Device or resource busy	
61	EEXIST	File exists	
62	EXDEV	Cross-device link	
63	ENODEV	No such device	
64	ENOTDIR	Not a directory	
65	EISDIR	Is a directory	
66	EINVAL	Invalid argument	
67	ENFILE	Too many open files in system	
68	EMFILE	File descriptor value too large	
69	ENOTTY	Not a character device	
6A	ETXTBSY	Text file busy	
6B	EFBIG	File too large	
6C	ENOSPC	No space left on device	
6D	ESPIPE	Illegal seek	
6E	EROFS	Read-only file system	
6F	EMLINK	Too many links	
70	EPIPE	Broken pipe	
71	EDOM	Mathematics argument out of domain of function	
72	ERANGE	Result too large	
73	ENOMSG	No message of desired type	
74	EIDRM	Identifier removed	

75	ECHRNG	Channel number out of range	
76	EL2NSYNC	Level 2 not synchronized	
77	EL3HLT	Level 3 halted	
78	EL3RST	Level 3 reset	
79	ELNRNG	Link number out of range	
7A	EUNATCH	Protocol driver not attached	
7B	ENOCSE	No CSI structure available	
7C	EL2HLT	Level 2 halted	
7D	EDEADLK	Deadlock	
7E	ENOLCK	No lock	
7F	-		
80	-		
81	-		
82	EBADE	Invalid exchange	
83	EBADR	Invalid request descriptor	
84	EXFULL	Exchange full	
85	ENOANO	No anode	
86	EBADRQC	Invalid request code	
87	EBADSLT	Invalid slot	
88	EDEADLOCK	File locking deadlock error	
89	EBFONT	Bad font file fmt	
8C	ENOSTR	Not a stream	
8D	ENODATA	No data (for no delay io)	
8E	ETIME	Stream ioctl timeout	
8F	ENOSR	No stream resources	
90	ENONET	Machine is not on the network	
91	ENOPKG	Package not installed	
92	EREMOTE	The object is remote	
93	ENOLINK	Virtual circuit is gone	
94	EADV	Advertise error	
95	ESRMNT	Srmount error	
96	ECOMM	Communication error on send	
97	EPROTO	Protocol error	
98	-		
99	-		
9A	EMULTIHOP	Multihop attempted	
9B	ELBIN	Inode is remote (not really error)	
9C	EDOTDOT	Cross mount point (not really error)	
9D	EBADMSG	Bad message	
9E	-		

9F	EFTYPE	Inappropriate file type or format	
A0	ENOTUNIQ	Given log. Name not unique	
A1	EBADFD	f.d. invalid for this operation	
A2	EREMCHG	Remote address changed	
A3	ELIBACC	Can't access a needed shared lib	
A4	ELIBBAD	Accessing a corrupted shared lib	
A5	ELIBSCN	.lib section in a.out corrupted	
A6	ELIBMAX	Attempting to link in too many libs	
A7	ELIBEXEC	Attempting to exec a shared library	
A8	ENOSYS	Function not implemented	
A9	ENMFILE	No more files	
AA	ENOTEMPTY	Directory not empty	
AB	ENAMETOOLONG	File or path name too long	
AC	ELOOP	Too many symbolic links	
AD	-		
AE	-		
AF	EOPNOTSUPP	Operation not supported on socket	
B0	EPFNOSUPPORT	Protocol family not supported	
B1	-		
B2	-		
B3	-		
B4	-		
B5	-		
B6	-		
B7	-		
B8	ECONNRESET	Connection reset by peer	
B9	ENOBUFS	No buffer space available	
BA	EAFNOSUPPORT	Address family not supported by protocol family	
BB	EPROTOTYPE	Protocol wrong type for socket	
BC	ENOTSOCK	Socket operation on non-socket	
BD	ENOPROTOPT	Protocol not available	
BE	ESHUTDOWN	Can't send after socket shutdown	
BF	ECONNREFUSED	Connection refused	
C0	EADDRINUSE	Address already in use	
C1	ECONNABORTED	Software caused connection abort	
C2	ENETUNREACH	Network is unreachable	
C3	ENETDOWN	Network interface is not configured	
C4	ETIMEDOUT	Connection timed out	
C5	EHOSTDOWN	Host is down	

C6	EHOSTUNREACH	Host is unreachable	
C7	EINPROGRESS	Connection already in progress	
C8	EALREADY	Socket already connected	
C9	EDESTADDRREQ	Destination address required	
CA	EMSGSIZE	Message too long	
CB	EPROTONOSUPPORT	Unknown protocol	
CC	ESOCKTNOSUPPORT	Socket type not supported	
CD	EADDRNOTAVAIL	Address not available	
CE	ENETRESET	Connection aborted by network	
CF	EISCONN	Socket is already connected	
D0	ENOTCONN	Socket is not connected	
D1	ETOOMANYREFS	Too many references: cannot splice	
D2	EPROCLIM	Too many process	
D3	EUSERS	Too many users	
D4	EDQUOT	Quota exceeded	
D5	ESTALE	Stale NFS file handle	
D6	ENOTSUP	Not supported	
D7	ENOMEDIUM	No medium (in tape drive)	
D8	ENOSHARE	No such host or network path	
D9	ECASECLASH	Filename exists with different case	
DA	EILSEQ	Illegal byte sequence	
DB	E_OVERFLOW	Value too large for defined data type	
DC	ECANCELED	Operation canceled	
DD	ENOTRECOVERABLE	State not recoverable	
DE	EOWNERDEAD	Previous owner died	
DF	ESTRPIPE	Streams pipe error	

7 Fatal Error

After output Fatal error response, the module will be rebooted.

#	Name	Description
00	Hardware fault	Hardware fault
01	Critical error	WLAN initialization failure
02	Critical error	Application Framework initialization failure
03	Critical error	Application Framework critical error
04	SDK critical error	SDK critical error
05	SDK panic	SDK panic
06	Stack overflow	Stack overflow
07	Heap overflow	Heap overflow

8 Message Sequence Chart

8.1 Scan and scan result detail

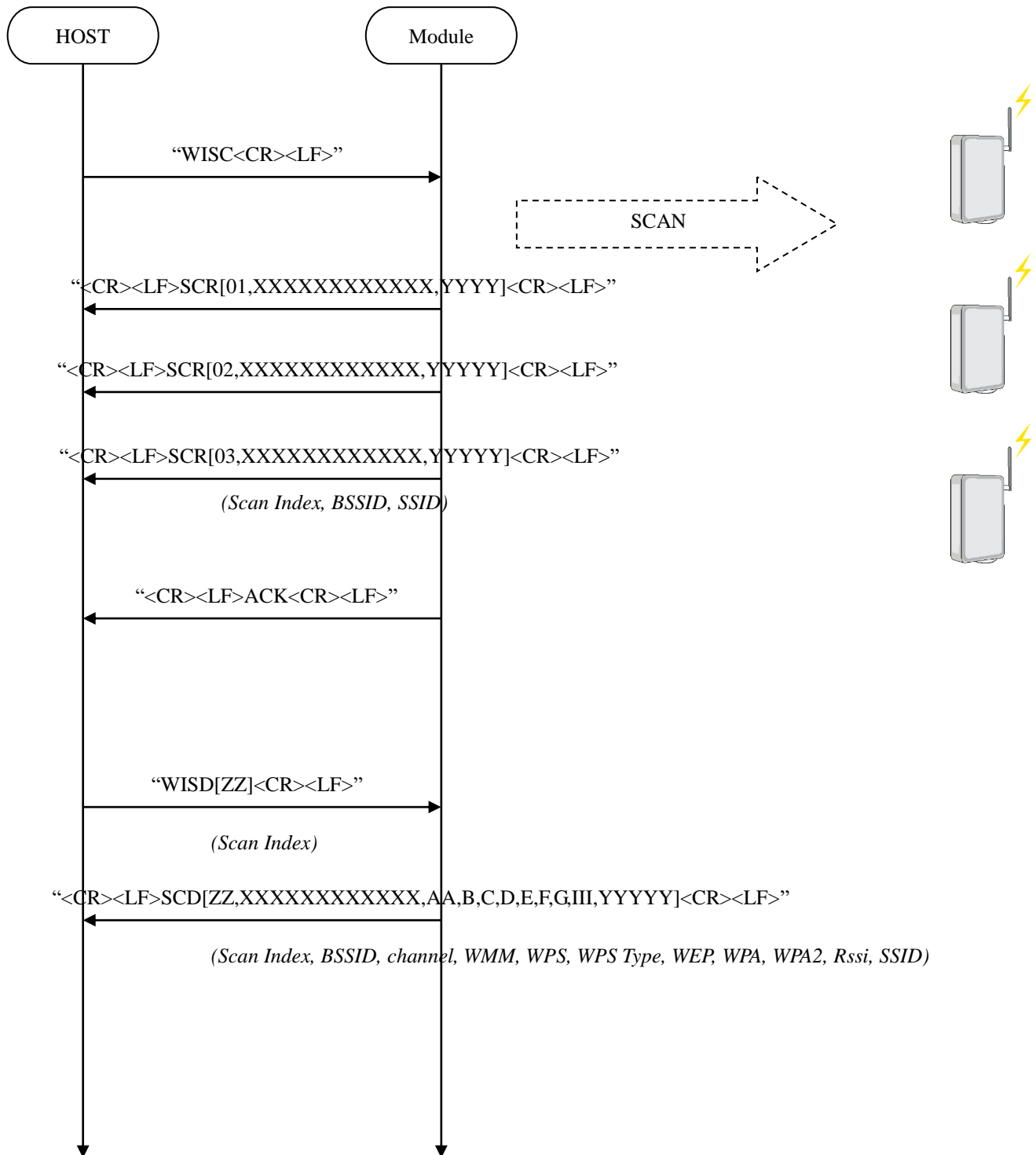

8.2 Connect

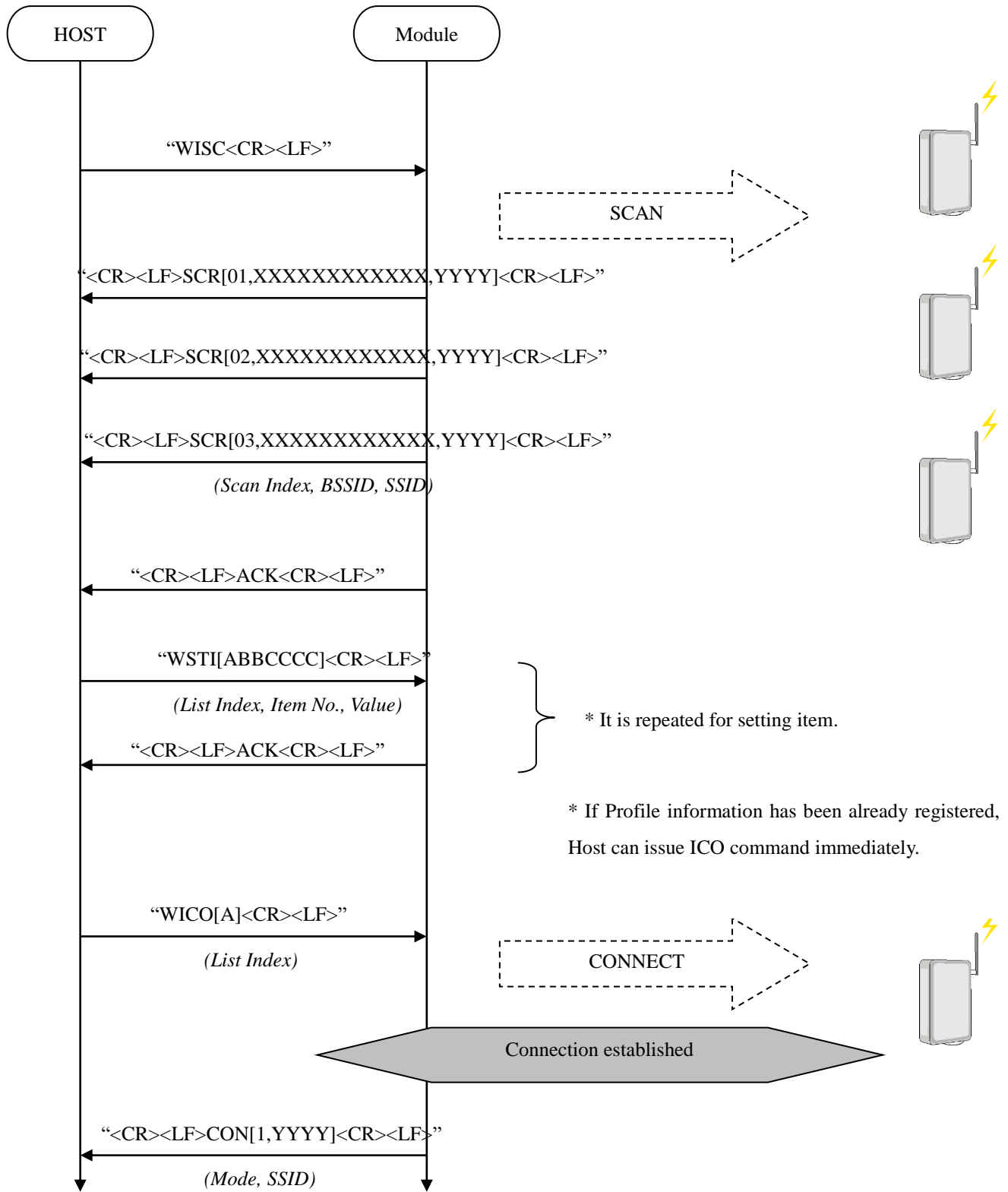

8.3 Socket Interface usage (TCP)

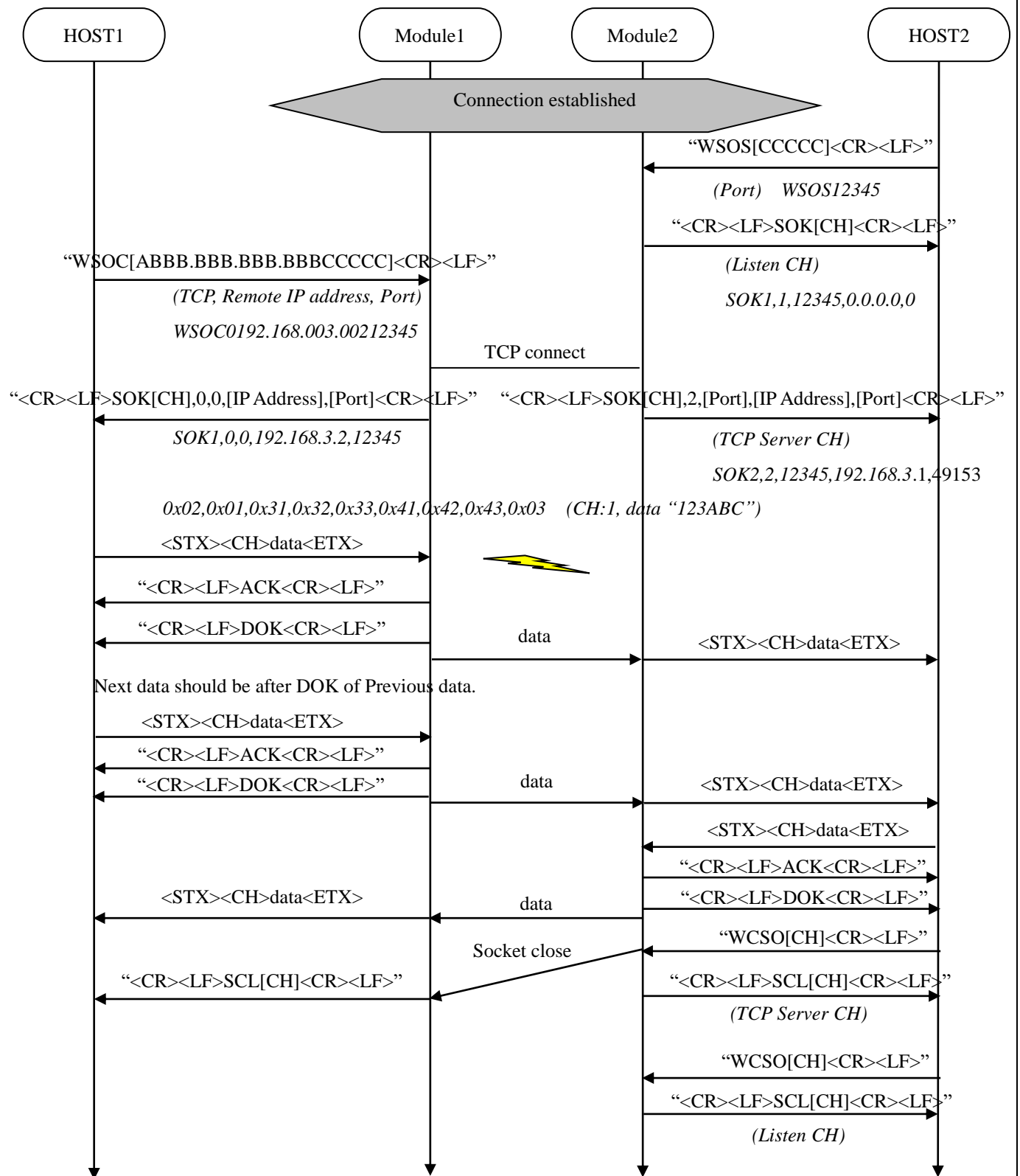

8.4 Socket Interface usage (UDP)

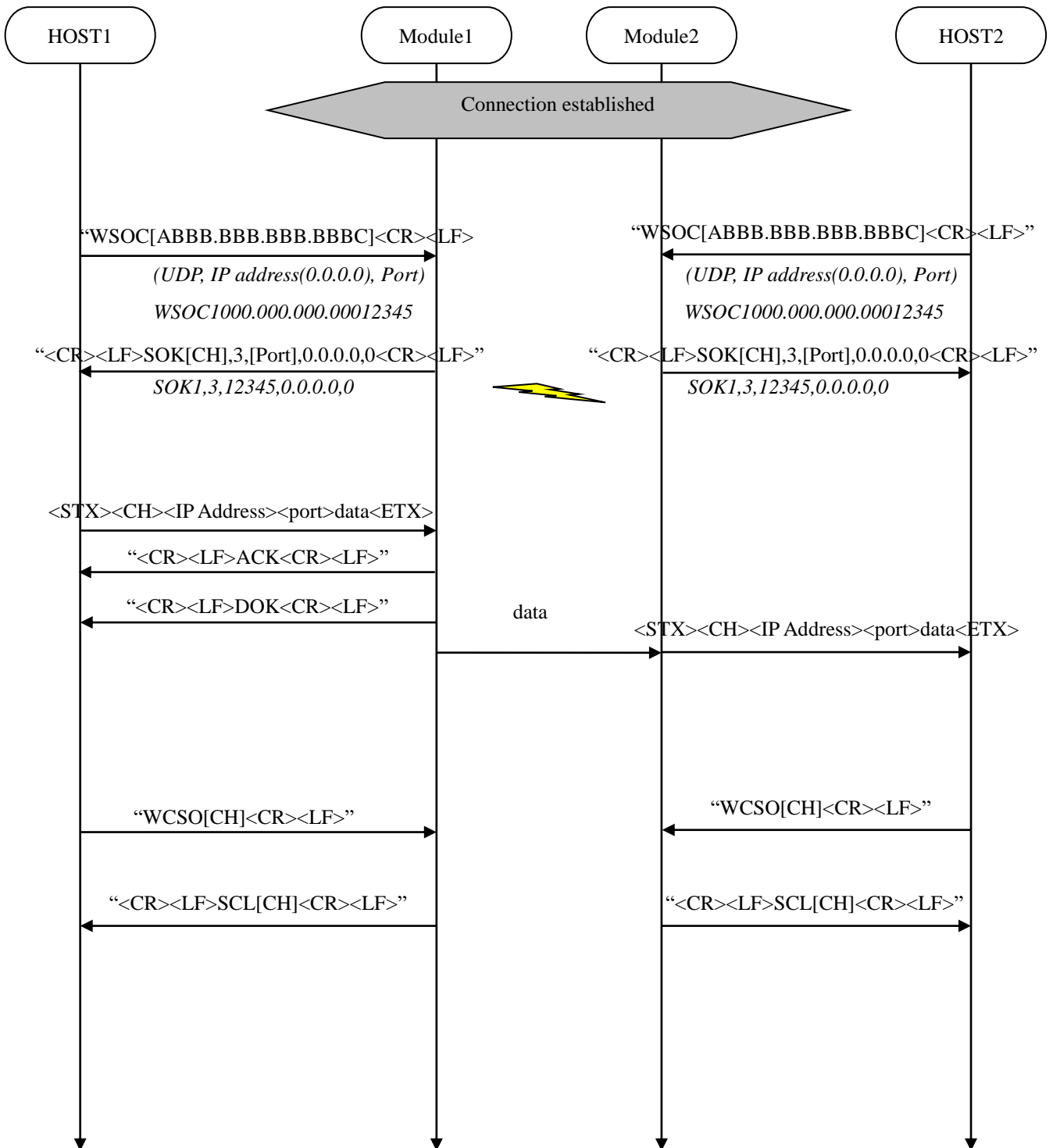

8.5 WPS

8.5.1 Infrastructure mode (WPS Enrollee)

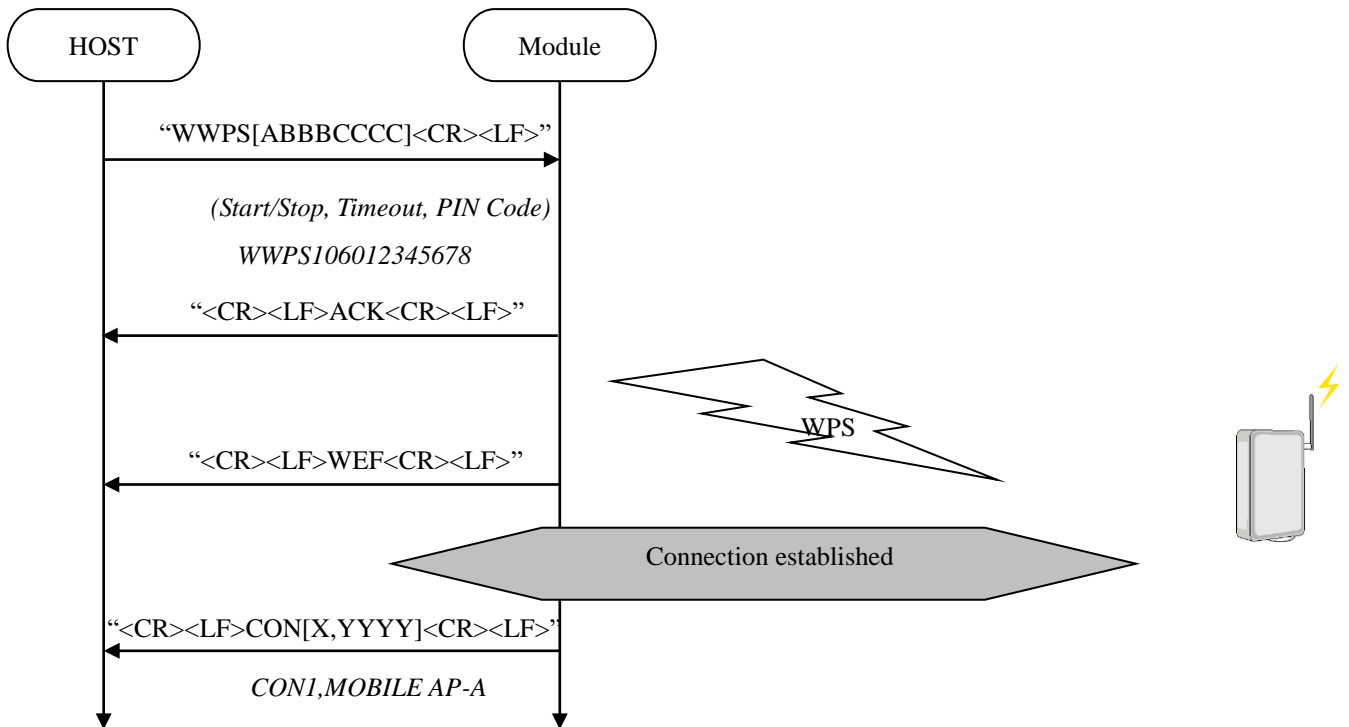

8.5.2 uAP mode (WPS Registrar)

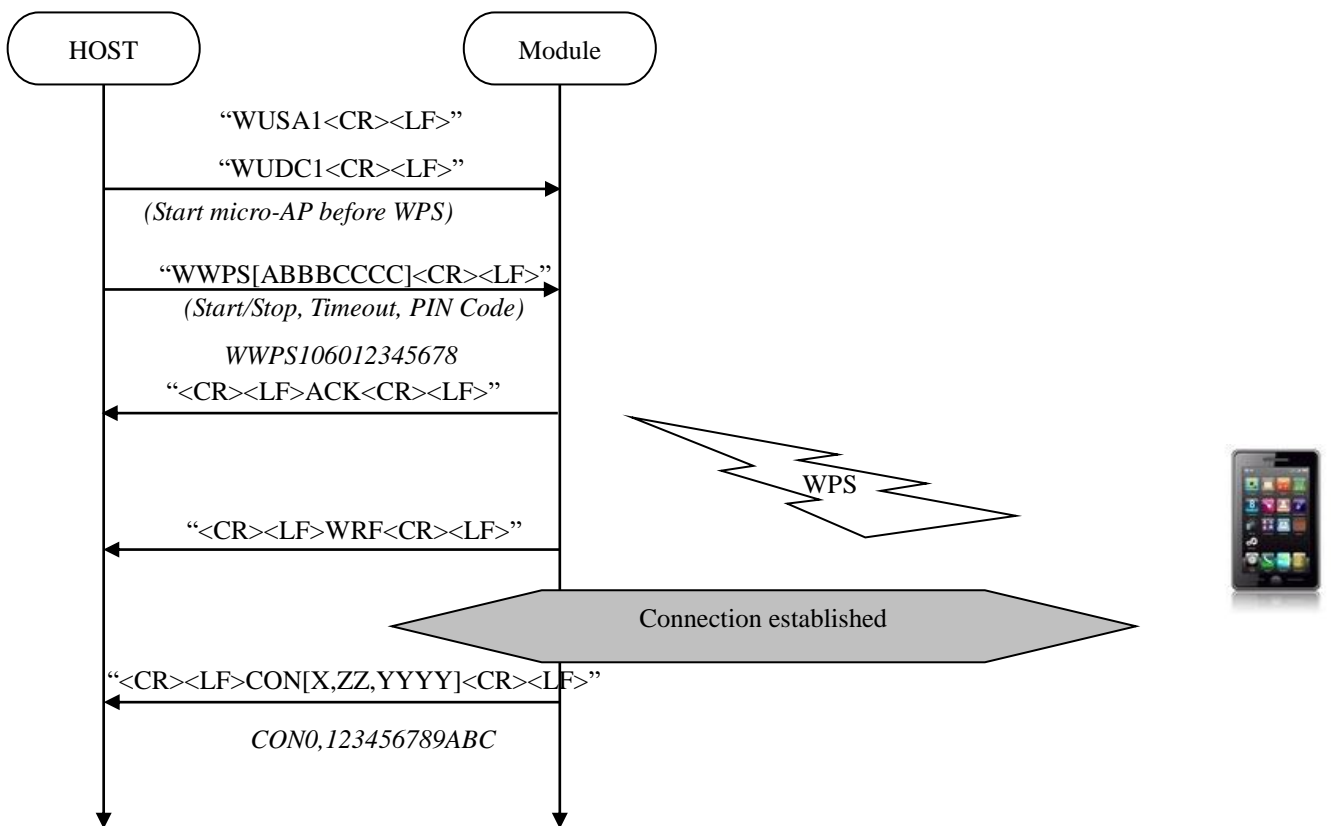

8.6 HTTP Request

8.6.1 GET

8.6.2 POST

8.6.3 PUT

8.6.4 DELETE

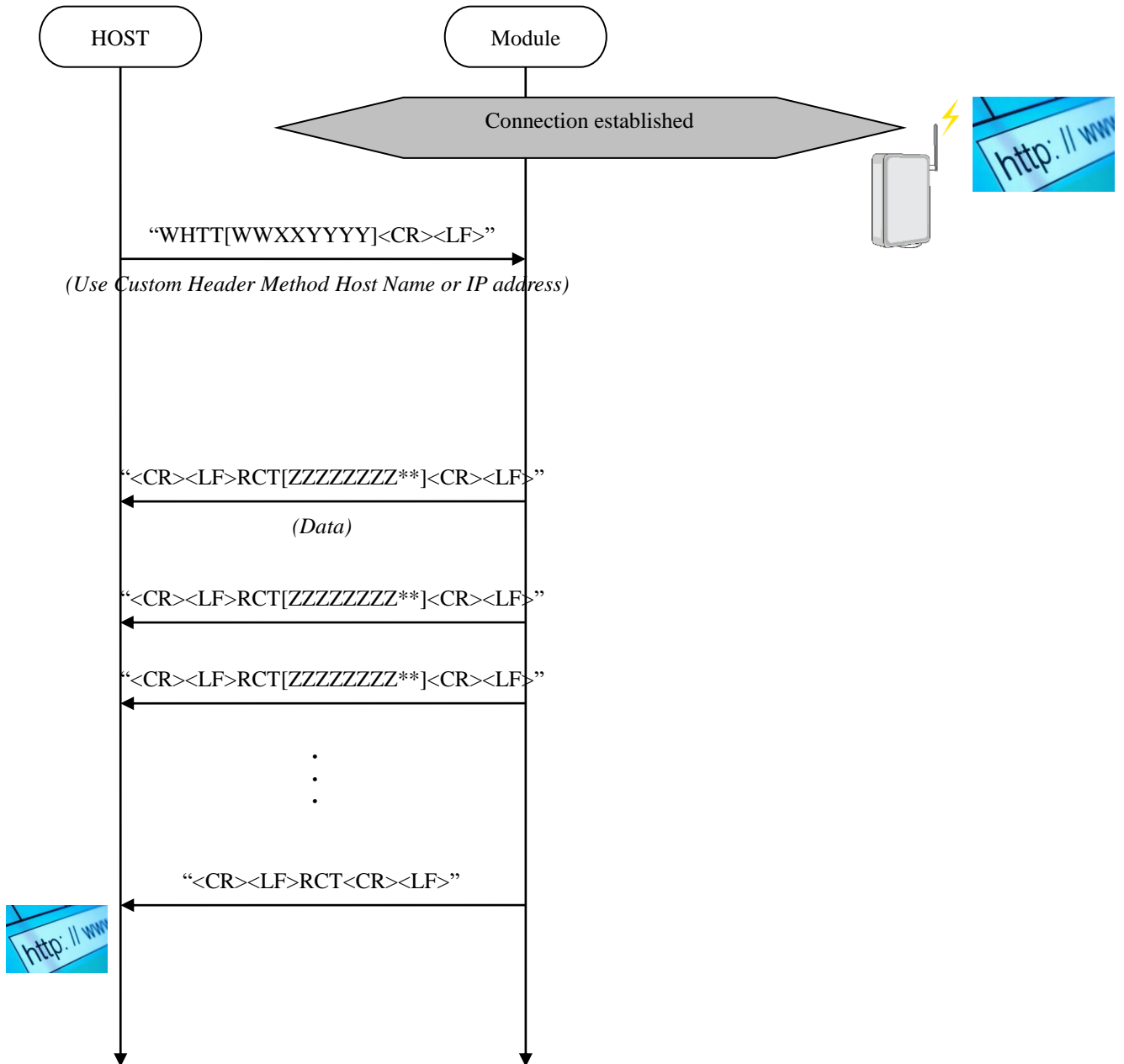

8.7 WEB Configuration

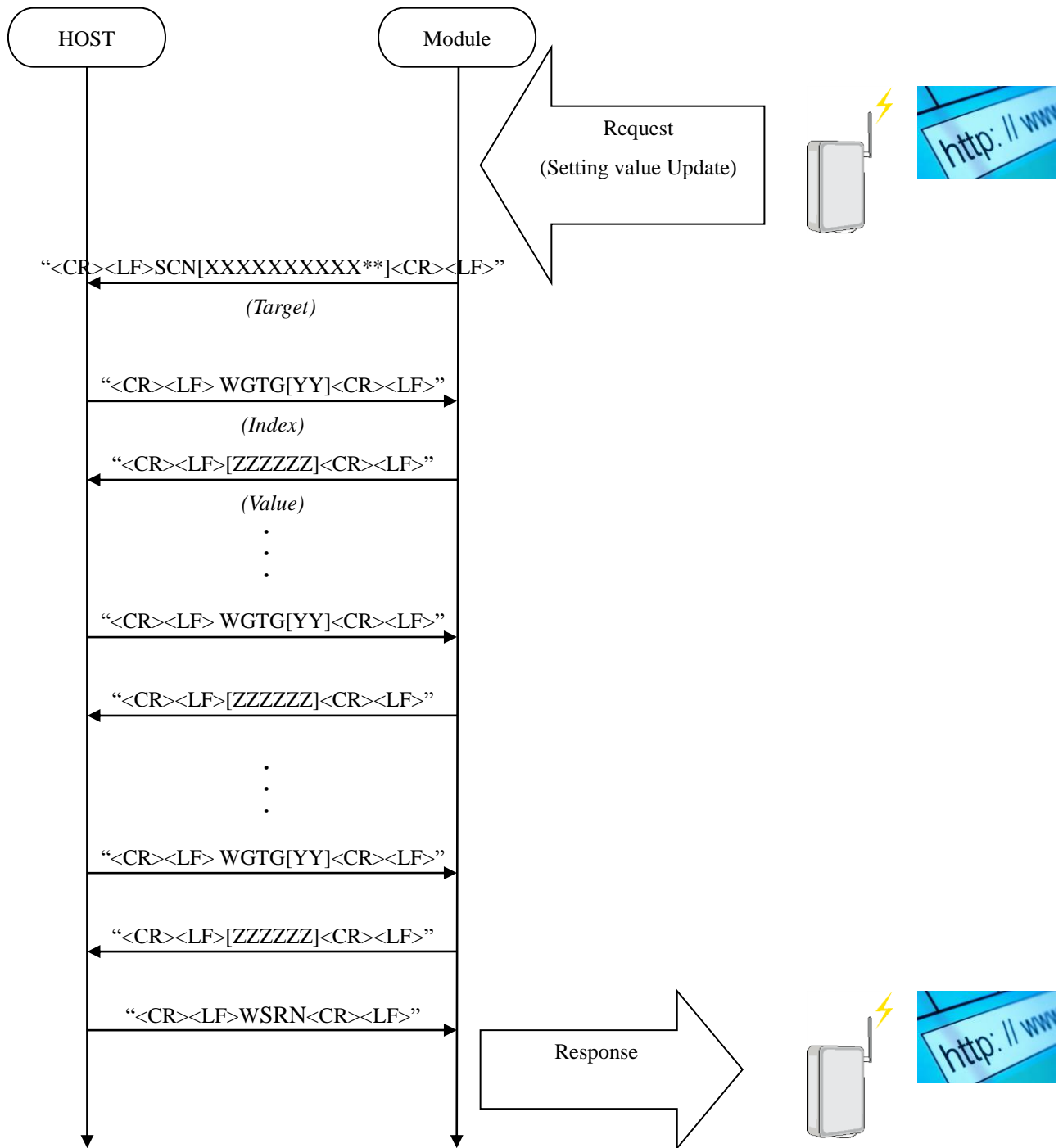

9 Note

1. When the module receives HTTP content and Socket data at the same time, there is a possibility that they are mixed in UART output.
2. While infrastructure network is connected, micro-AP can start only under the following condition.
channel = 00 and channel specific = 0
3. The maximum number of micro-AP clients is 8.
4. The security of micro-AP mode can be set only either “No security” or “WPA2-PSK (AES)”.
5. Received TCP/UDP socket data is divided into maximum 730byte data and converted into TY's App format then sent to the host in order.
Therefore, if whole data don't need to be escaped, maximum size of each data from TY's App is 730byte.
6. Maximum UDP packet size that TY's App can receive is 3072byte.
Received UDP data is sent to the host every 730byte until 3072byte and further data is discard.
7. When user certificates option is enabled in STC command and invalid certificate is included, NAK32 is returned in HTT command.
In HTTPS communication, when TY's App fails in the server verification, NAK30 is returned in HTT command.
It is necessary for the server verification to set the time with STT command.
8. To comply with ETSI R&TTE EN 300 328 adaptivity requirement, enable Energy Detection with STC command.
9. DPS command affects only wlan chip and SBY command affects only MCU.
Therefore, when both wlan chip and MCU put into low power mode, execute both commands in turn.
10. When the module run concurrently in micro-AP mode and Infrastructure mode, each network shall be set diffent subnets.
Running these modes in the same subnetwork is not guaranteed.
11. When the module is connected to AP by DHCP in Infrastructure mode, “TCP Client” and “TCP Server (Accepted)” socket will be closed.
12. While HTTP Server is running and SSL certificate option for HTTPS is pre-installed certificates, HTT command returns NAK34.
Please stop HTTP Server before HTT command or change SSL certificate option for HTTPS if both functions run concurrently.
13. If the writing to FLASH command (STC, STI, STU, SCT, STG and SHD) is repeated, FLASH access performance gradually drops. Therefore, the FLASH compaction (relocation) is processed so that the worst performance falls within about 100ms without UART output.
The compaction is performed every 3000 times write commands or about total 300KB write size, whichever comes earlier, in the write command and it takes about 3500ms to complete the process.

10 Known issues

1. If you send data in a socket while receiving data in two or more sockets at the same time at high speed, it may cause IP stack hang up.
In that case, the module needs reset for a recovery.
2. GSS command rarely returns NAKFF when IEEE PS is enabled.
In that case, wait more than 30 seconds for retrying GSS command or reset then reconnect.
3. HTT command cannot connect to some web server which uses the following root certificate.
DigiCert Assured ID Root G3
4. UFW command may not be executed again before reboot **once firmware update ends in success**.
If the last UFW command fails or is suspended, the module will not boot and can not recover.
5. Immediately after writing to FLASH command (STC, STI, STU, SCT, STG and SHD), reading command (GTC, GTI, GTU, GCT, GTG and GHD) may fails.
In that case, put the wait between writing and reading.

Appendix A.

Configuration Table (This information is written in flash memory.)

1. Infrastructure configuration

Profile table

List Index	S	Security Type	P	Addr Type	IP Addr	Subnet Mask	Default GW	Primary DNS Server	Secondary DNS Server	b	channel	bssid Specific	Channel Specific
0										s			
1										s			
2										s			
3										i			
4										d			

2. micro-AP configuration

Profile Table

List Index	S	Security Type	P	Addr Type	IP Addr	Subnet Mask	Default GW	Primary DNS Server	Secondary DNS Server	b	channel	bssid Specific	Channel Specific
1				-									

List Index	MAC Address filtering	Allowed MAC Address 1	Allowed MAC Address 2	Allowed MAC Address 3	Allowed MAC Address 4	Allowed MAC Address 5
1						

Appendix B.

Factory reset value

Factory setting / ERS command without parameter / Force Initialization (GPIO_4 (I2C0_SDA, PIN11))

* In ERS command, UART baud rate is not initialized.

Common value (STC, GTC)

No.	Item Name	value
01	UART baud rate (bps)	00 : 115200
02	Auto connect flag	00 : OFF
03	IEEE PS	00 : OFF
04	SSL certificate option for HTTPS	01 : pre-installed certificates only
05	Energy Detection	00 : OFF
06	Listen Interval	01 : 1

Profile (STI, GTI, STU, GTU)

Infrastructure profile 0 : unavailable

The values of other profiles are below.

No.	Item Name	Value
01	ssid	Null
02	security type	0 : No security
03	security key	Null
04	addr_type	0 : Static
05	IP address	000.000.000.000
06	subnet mask	000.000.000.000
07	default gateway	000.000.000.000
08	primary DNS server	000.000.000.000
09	secondary DNS server	000.000.000.000
10	bssid	000000000000
11	channel	00 : any channel.
12	bssid specific	0 : connect to any network whose SSID matches.
13	channel specific	0 : any available channel
20 (STU/GTU)	MAC Address filtering	0 : Disable
21-25 (STU/GTU)	Allowed MAC Address	FFFFFFFFFFFF

User certificates (SCT, GCT)

No.	Value
1	Null
2	Null
3	Null
4	Null
5	Null

Appendix C.

Pre-installed certificates

2018/02/05

<https://pki.google.com/roots.pem> (in <https://pki.google.com/faq.html>)

label	pre-installed	
Comodo AAA Services root	○	
AddTrust Low-Value Services Root	○	
AddTrust External Root	○	
AddTrust Public Services Root	○	
AddTrust Qualified Certificates Root	○	
COMODO Certification Authority	○	
COMODO ECC Certification Authority	×	
COMODO RSA Certification Authority	○	
Comodo Secure Services root	○	
Comodo Trusted Services root	○	
USERTrust ECC Certification Authority	×	
USERTrust RSA Certification Authority	○	
UTN USERFirst Hardware Root CA	○	
Baltimore CyberTrust Root	○	
Cybertrust Global Root	○	
DigiCert Assured ID Root CA	○	
DigiCert Assured ID Root G2	○	
DigiCert Assured ID Root G3	×	See Known issues
DigiCert Global Root CA	○	
DigiCert Global Root G2	○	
DigiCert Global Root G3	×	
DigiCert High Assurance EV Root CA	○	
DigiCert Trusted Root G4	○	
Entrust Root Certification Authority	○	
Entrust Root Certification Authority - EC1	×	
Entrust Root Certification Authority - G2	○	
Entrust.net Premium 2048 Secure Server CA	○	
GlobalSign Root CA	○	
GlobalSign Root CA - R2	○	
GlobalSign Root CA - R3	○	
GlobalSign ECC Root CA - R4	×	
GlobalSign ECC Root CA - R5	×	
GlobalSign Root CA - R6	○	
GlobalSign Root CA - R8	○	

Go Daddy Root Certificate Authority - G2	○	
Starfield Root Certificate Authority - G2	○	
Starfield Class 2 CA	○	
Go Daddy Class 2 CA	○	
Equifax Secure CA	○	
GeoTrust Global CA	○	
GeoTrust Global CA 2	○	
GeoTrust Primary Certification Authority	○	
GeoTrust Primary Certification Authority - G2	○	
GeoTrust Primary Certification Authority - G3	○	
GeoTrust Universal CA	○	
GeoTrust Universal CA 2	○	
thawte Primary Root CA	○	
thawte Primary Root CA - G2	×	
thawte Primary Root CA - G3	×	
Verisign Class 3 Public Primary Certification Authority - G3	○	
VeriSign Class 3 Public Primary Certification Authority - G4	○	
VeriSign Class 3 Public Primary Certification Authority - G5	○	
VeriSign Universal Root Certification Authority	○	
AffirmTrust Commercial	○	
AffirmTrust Networking	○	
AffirmTrust Premium	○	
AffirmTrust Premium ECC	×	
GTS Root R1	○	
GTS Root R2	○	
GTS Root R3	○	
GTS Root R4	○	

Appendix D.

Usage in EU

Set the following common value when you use in EU.

[Adaptivity requirement of ETSI R&TTE EN 300 328]

Enable Energy Detection

STC command No.05

WSTC0501<CR><LF>

Energy Detection ON

Appendix E.

Open Source Licenses

FreeRTOS GNU General Public License Exception

Any FreeRTOS source code, whether modified or in its original release form, or whether in whole or in part, can only be distributed by you under the terms of the GNU General Public License plus this exception. An independent module is a module which is not derived from or based on FreeRTOS.

EXCEPTION TEXT:

Clause 1

Linking FreeRTOS statically or dynamically with other modules is making a combined work based on FreeRTOS. Thus, the terms and conditions of the GNU General Public License cover the whole combination.

As a special exception, the copyright holder of FreeRTOS gives you permission to link FreeRTOS with independent modules that communicate with FreeRTOS solely through the FreeRTOS API interface, regardless of the license terms of these independent modules, and to copy and distribute the resulting combined work under terms of your choice, provided that

1. Every copy of the combined work is accompanied by a written statement that details to the recipient the version of FreeRTOS used and an offer by yourself to provide the FreeRTOS source code (including any modifications you may have made) should the recipient request it.
2. The combined work is not itself an RTOS, scheduler, kernel or related product.
3. The independent modules add significant and primary functionality to FreeRTOS and do not merely extend the existing functionality already present in FreeRTOS.

Clause 2

FreeRTOS may not be used for any competitive or comparative purpose, including the publication of any form of run time or compile time metric, without the express permission of Real Time Engineers Ltd. (this is the norm within the industry and is intended to ensure information accuracy).

lwIP LICENSE

lwIP is licenced under the BSD licence:

Copyright (c) 2001-2004 Swedish Institute of Computer Science.

All rights reserved.

Redistribution and use in source and binary forms, with or without modification, are permitted provided that the following conditions are met:

1. Redistributions of source code must retain the above copyright notice, this list of conditions and the following disclaimer.
2. Redistributions in binary form must reproduce the above copyright notice, this list of conditions and the following disclaimer in the documentation and/or other materials provided with the distribution.
3. The name of the author may not be used to endorse or promote products derived from this software without specific prior written permission.

THIS SOFTWARE IS PROVIDED BY THE AUTHOR "AS IS" AND ANY EXPRESS OR IMPLIED WARRANTIES,

INCLUDING, BUT NOT LIMITED TO, THE IMPLIED WARRANTIES OF MERCHANTABILITY AND FITNESS FOR A PARTICULAR PURPOSE ARE DISCLAIMED. IN NO EVENT SHALL THE AUTHOR BE LIABLE FOR ANY DIRECT, INDIRECT, INCIDENTAL, SPECIAL, EXEMPLARY, OR CONSEQUENTIAL DAMAGES (INCLUDING, BUT NOT LIMITED TO, PROCUREMENT OF SUBSTITUTE GOODS OR SERVICES; LOSS OF USE, DATA, OR PROFITS; OR BUSINESS INTERRUPTION) HOWEVER CAUSED AND ON ANY THEORY OF LIABILITY, WHETHER IN CONTRACT, STRICT LIABILITY, OR TORT (INCLUDING NEGLIGENCE OR OTHERWISE) ARISING IN ANY WAY OUT OF THE USE OF THIS SOFTWARE, EVEN IF ADVISED OF THE POSSIBILITY OF SUCH DAMAGE.