

## U.FL Series

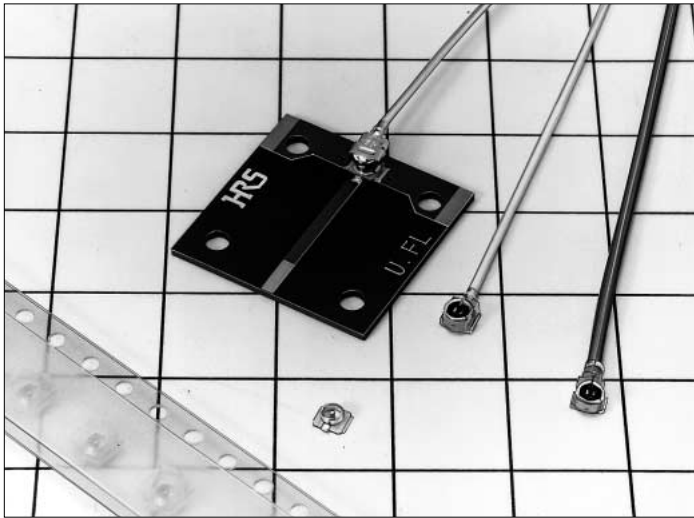

### ■ Features

#### 1. Mating Heights Owing to World's Lowest Profile

Height from the printed circuit board when mates a receptacle with a (right-angle) plug is 2.5 mm maximum. This low Profile is at the world's shortest level.

#### 2. Extremely Small Board Occupation Area

In comparison with our E.FL Series of SMT coaxial connectors, the receptacles offer a reduction of approximately 18% of the board occupation area resulting in an area of just 7.7 mm<sup>2</sup>.

#### 3. World's Lightest

These are the world's lightest coaxial connectors.

Receptacle: 15.7 mg

Right-angle plugs + Female center contacts

For  $\phi$  0.81 mm cable: 53.7 mg

For  $\phi$  1.13 & 1.32 mm cable: 59.1 mg

#### 4. Can Be Used Up to a Frequency of 6 GHz

To meet the frequency requirements of a wide variety of miniature equipment, these connectors offer high frequency performance from DC to 6 GHz.

#### 5. Can Be Used with Automatic Mounting

The embossed tape packaging specification of the receptacles permits automatic mounting.

#### 6. Use of Ultra-Fine Teflon Cable

From among the types of suitable cable,  $\phi$  0.8 mm (single shield) outside diameter ultra-fine Teflon coaxial cable has been made a standard specification in consideration of improving the construction qualities and construction area.

An external diameter  $\phi$ 1.32 mm (double shield) &  $\phi$ 1.13mm (single shield) ultra-fine Teflon coaxial cable specification is also available.

#### 7. Simple Removal of Connectors

The extraction jig permits simple removal of connectors.

#### 8. Mating Checks Are Easy

Subminiature size notwithstanding, the lock sensation permits a check of sure mating.

### Meets up to 6 GHz Requirement

Figure 1. Mating Height Comparison (with Hirose Electric Products)

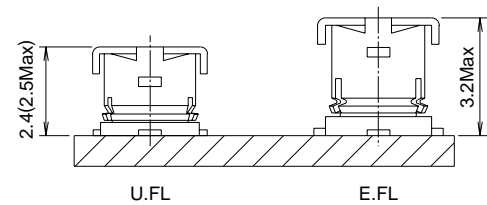

### ● Space Factor of Mated Connector

Figure 2. U.FL-LP-040 and U.FL-R-SMT

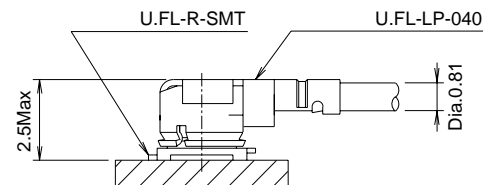
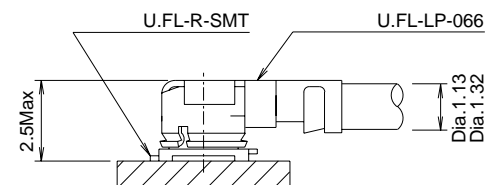

Figure 3. U.FL-LP-066 and U.FL-R-SMT



### ■ Applications

Mobile phones, wireless communications equipment, electronic measuring instruments, GPS, wireless LAN, Bluetooth etc.

## ■ Product Specifications

Ratings	Nominal characteristic impedance Rated voltage Rated frequency	50Ω 60 V AC (rms) DC to 6 GHz	Operating temperature range Operating humidity	-40°C to +90°C 90% max.
---------	--	-------------------------------------	---	----------------------------

Item	Specification	Conditions
1. Contact resistance	Center: 20 mΩ max. Outside: 10 mΩ max.	Measured at 10 mA max.
2. Insulation resistance	500 MΩ min.	Measured at 100 V DC
3. Withstand voltage	No line or insulation breakdown	200 V AC for 1 minute
4. V.S.W.R.*	1.3 max.	
	Dia.0.81Cable	1.35
	Dia.1.13Cable	1.4
	Dia.1.32Cable	1.5
5. Female contact holding force	0.15 N min.	Measured with a $\phi$ 0.475 pin gauge
6. Repetitive operation	Contact resistance 25 mΩ max. (Center) 15 mΩ max. (Outside)	30 cycles of insertion and disengagement
7. Vibration	No momentary disconnections of 1 $\mu$ s min. No damage, cracks, or parts looseness min.	Frequency of 10 to 100 Hz, single amplitude of 1.5 mm, acceleration of 59 m/s <sup>2</sup> , for 5 cycles in the direction of each of the 3 axes
8. Shock	No momentary disconnections of 1 $\mu$ s min. No damage, cracks, or parts looseness	Acceleration of 735 m/s <sup>2</sup> , 11 ms duration, sine half-wave waveform, for 6 cycles in the direction of each of the 3 axes
9. Humidity resistance (Steady state)	No damage, cracks, or parts looseness Insulation resistance 100 MΩ min.(High temperature) Insulation resistance 500 MΩ min.(Pry)	Temperature of 40°C, humidity of 95%, let stand for 96 hours
10. Temperature cycle	No damage, cracks, or parts looseness Contact resistance 25 mΩ max. (Center) 15 mΩ max. (Outside)	Temperature: +40°C → 5 to 35°C → +90°C → 5 to 35°C Time: 30 min. → Within 5 min. → 30 min. → Within 5 min. Cycles: 5
11. Salt spray test	No excessive corrosion	48 hours continuous exposure to 5% salt water

\*V.S.W.R. Measurement System

The above V.S.W.R. standard values were measured using the measurement system of the diagram below.

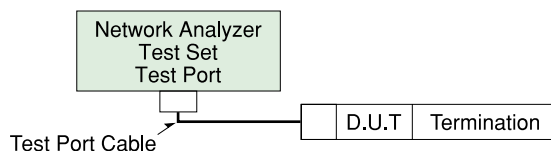

NOTE 1: Cable type connectors were measured with SMA conversion adapters attached to both ends of the harness product of a suitable 100-cm cable.

NOTE 2: Board type connectors were mounted to a 50Ω glass epoxy board and measurements were conducted with SMA conversion adapters attached.

## ■ Materials

Part	Material	Finish	Remarks
Shell	Phosphor bronze	Silver plating	————
Male center contact	Brass	Gold plating	————
Female center contact	Phosphor bronze	Gold plating	————
Insulator	Plug	PBT	Black UL94V-0
	Receptacle	LCP	Beige UL94V-0

## Plugs

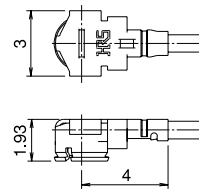

Form of Plug After Cable Wiring

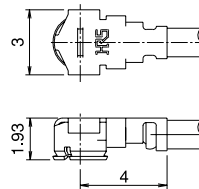

Form of Plug After Cable Wiring

Item	HRS No.	Part No.	Applicable Cable	Weight (mg)
Right-angle plug shell (for $\phi$ 0.81 cable)	CL331-0451-2	U.FL-LP-040	RF-MF5010 Manufactured by Nissei Electric Co., Ltd. CO-6F-SB-CX50 Manufactured by Hitachi Cable, Ltd. F12B0074-B Manufactured by Junkosha Co., Ltd.	53.7/unit
Right-angle receptacle (for $\phi$ 1.13 cable)	CL331-0452-5	U.FL-LP-066	RF-MF5016 Manufactured by Nissei Electric Co., Ltd. A12B1054 Manufactured by Junkosha Co., Ltd.	59.1/unit
Right-angle receptacle (for $\phi$ 1.32 cable)	CL331-0452-5	U.FL-LP-066	J12B0733 Manufactured by Junkosha Co., Ltd. CO-6F-DSB-CX-50 Manufactured by Hitachi Cable, Ltd.	59.1/unit

Please order plugs with the cable assembly specifications.

## Cable Assembly

Dimension of U.FL Series assembly products should be made as indicated below.

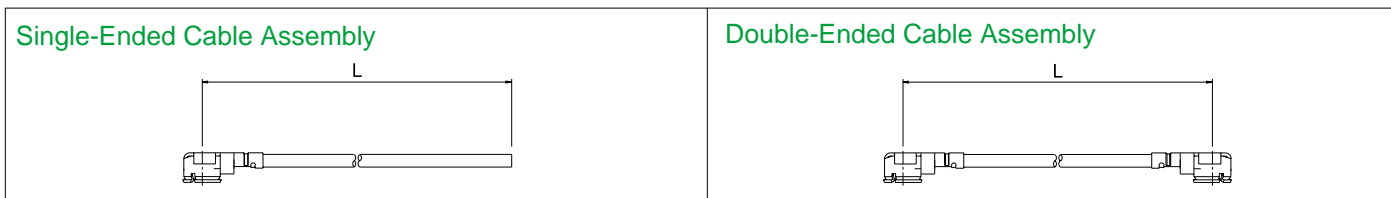

### Ordering Information

**U.FL - [1] LP - [2] - A - (L)**

①      ②      ③      ④

① Series name	U.FL
② Assembly type	Blank: Single ended 2: Double ended
③ Cable type	04 : For use with $\phi$ 0.81 cable 5016 : For use with $\phi$ 1.13 cable 066 : For use with $\phi$ 1.32 cable
④ Overall length (mm)	Length L is expressed in mm units.

### Cable Assembly Overall Length Standard Tolerance

Overall Length L (mm)	Standard Tolerance (mm)
$35 \leq L \leq 200$	$\pm 4$
$200 < L \leq 500$	$\pm 8$
$500 < L \leq 1000$	$\pm 12$
$1000 < L$	$\pm 1.5\%$

Note: Shortest length L is 35 mm.

Part No. of Cable Assembly	CL No.	Description
U.FL-2LP-04-A-(L)	321-1937-2-**	Dia. 0.81mm Double Ended Cable Assembly
U.FL-LP-04-A-(L)	321-1998-7-**	Dia. 0.81mm Single Ended Cable Assembly
U.FL-2LP-5016-A-(L)	321-2493-6-**	Dia. 1.13mm Double Ended Cable Assembly
U.FL-LP-5016-A-(L)	321-2492-3-**	Dia. 1.13mm Single Ended Cable Assembly
U.FL-2LP-066-A-(L)	321-2170-7-**	Dia. 1.32mm Double Ended Cable Assembly
U.FL-LP-066-A-(L)	321-2573-3-**	Dia. 1.32mm Single Ended Cable Assembly

Please contact Hirose Sales Representative about cable length and cable end treatment.

## ■ Receptacles

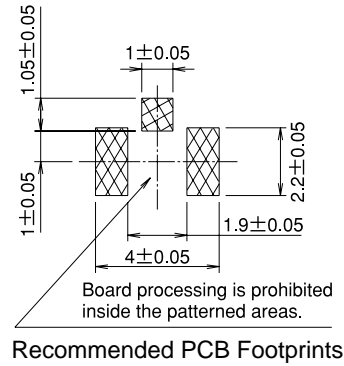
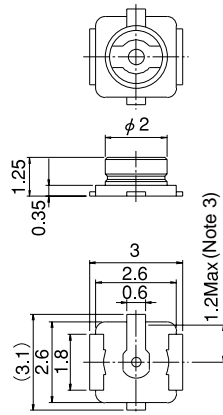
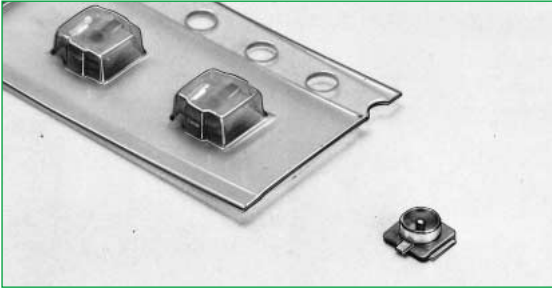

NOTE 1: Receptacles of the (01) specification are sold by the pack with 100 pieces per pack. Please order in pack units.

NOTE 2: Receptacles of the (10) specification are sold by the reel (which contains 2,500 pieces). Please order in reel units.

NOTE 3: Permissible value for mold resin which gets onto the center contact.

HRS No.	Part No.	Sales Quantity	Weight (mg)
CL331-0471-0-01	U.FL-R-SMT(01)	Pack sales (100 pieces per pack)	15.7/unit
CL331-0471-0-10	U.FL-R-SMT(10)	Reel sales (2,500 pieces per reel)	

## ● Packaging Specifications

### Embossed Carrier Tape Dimensions

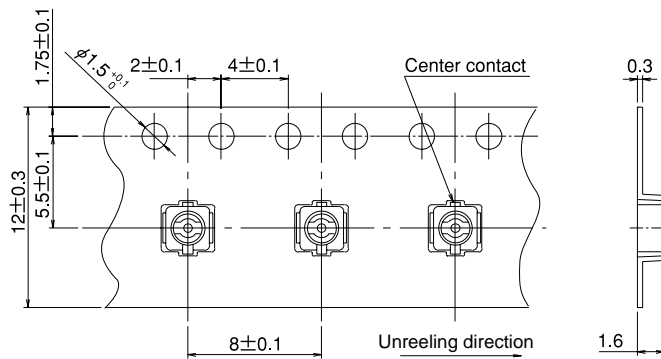

### Reel Dimensions

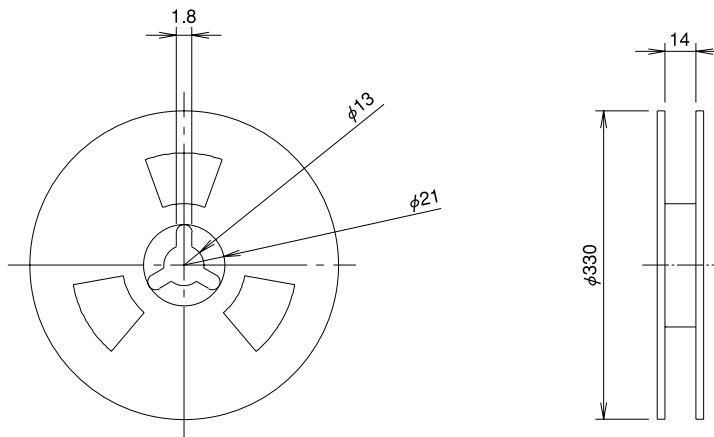

## ■ Conversion Adapter

### ● SMA Conversion Adapter

(Coupling portion: U.FL side jack - SMA side plug)



NOTE: The U.FL side coupling portion has a weaker lock than the regular product and, therefore, cannot be used for purposes other than performance measurements.

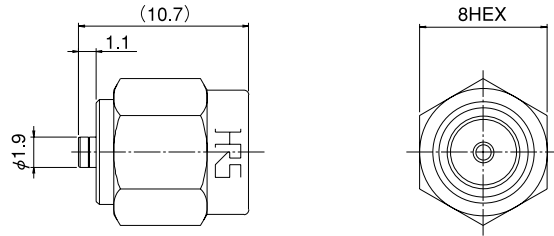

HRS No.	Product No.
CL311-0300-2	HRMP-U.FLJ

### ● SMA Conversion Adapter

(Coupling portion: U.FL side plug - SMA side jack)



NOTE: The U.FL side coupling portion has a weaker lock than the regular product and, therefore, cannot be used for purposes other than performance measurements.

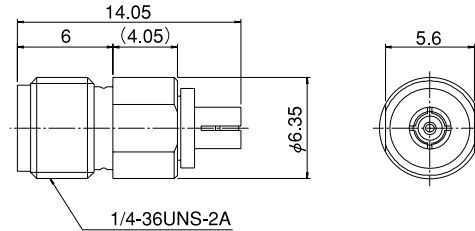

HRS No.	Product No.
CL311-0301-5	HRMJ-U.FLP

## ■ Inspection Receptacle

This receptacle is used for inspecting the continuity, withstand voltage, and other aspects of the harness product.



NOTE: The U.FL side coupling portion does not have a lock and, therefore, cannot be used for purposes other than continuity and withstand voltage inspections.

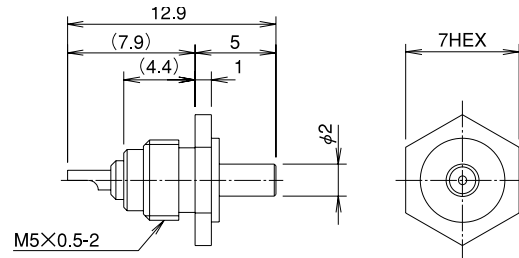

HRS No.	Product No.
CL331-0466-0	U.FL-R-1

## ■ Extraction Jig

This jig is used for extraction from a coupled condition.



NOTE: The extraction jig is the same one used with the E.FL Series

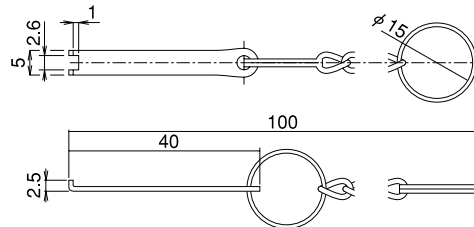

HRS No.	Product No.
CL331-0441-9	E.FL-LP-N

## Usage Precautions

### 1. Plugs

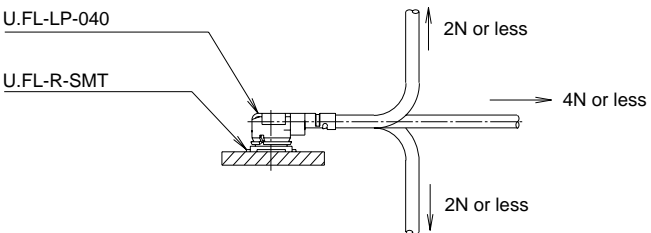
<p>(1) Connection/ disconnection of connectors</p>	<p>1) To disconnect connectors, hook the end portion of E.FL-LP-N onto the connector cover and pull off vertically in the direction of the connector coupling axis. To remove the connector directly, hold the connector cover and pull off vertically in the direction of the connector coupling axis. (Please exercise caution so as not to injure fingertips or nails.)</p> <p>2) To couple the connectors, the coupling axes of both connectors are aligned and the connectors are inserted as perpendicularly as possible. Do not attempt to insert on an extreme angle.</p>
<p>(2) Permissible load on the cable after connector coupling.</p>	<p>After the connectors are coupled, do not apply a load to the cable in excess of the values indicated in the diagram below.</p> 
<p>(3) Precautions</p>	<p>Please note that excessive twisting in the action of insertion or removal will cause damage.</p>

### 2. Receptacles

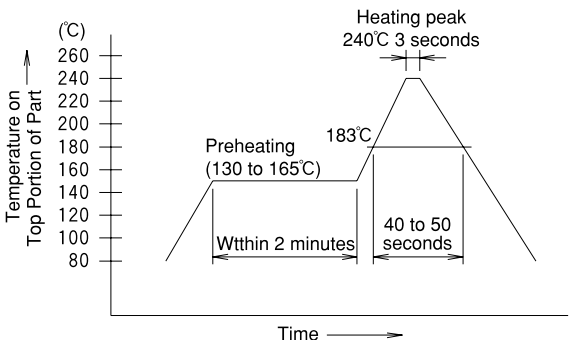
<p>(1) Recommended temperature profile (Reference)</p>	<p>Recommended Temperature Profile (Reference)</p>  <p>1) The temperature indicates the printed circuit board surface temperature of the connector lead portion. 2) The reflow soldering method should be performed at a peak temperature of 240°C or less at the surface of the printed circuit board. 3) The temperature profile will change depending on conditions which include such factors as the size of the board, the solder used, and the solder thickness.</p>
<p>(2) Recommended hand soldering conditions (Reference)</p>	<p>Soldering iron temperature: 350°C Soldering time: Within 5 seconds</p>
<p>(3) Recommended screen thickness</p>	<p>0.15 mm</p>



**HIROSE ELECTRIC CO., LTD.**

5-23, OSAKI 5-CHOME, SHINAGAWA-KU, TOKYO 141-8587, JAPAN

PHONE: 81-3-3491-9741

FAX : 81-3-3493-2933