

03 SGR

Circular connectors with threaded joint M16 acc. to IEC 61076-2-106, IP40/IP67/IP68



Chassis plug acc. to IEC 61076-2-106, IP 40, with threaded joint, for printed circuit boards, for back side mounting

03 SGR

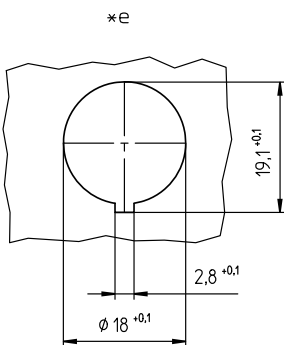
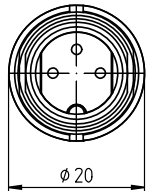
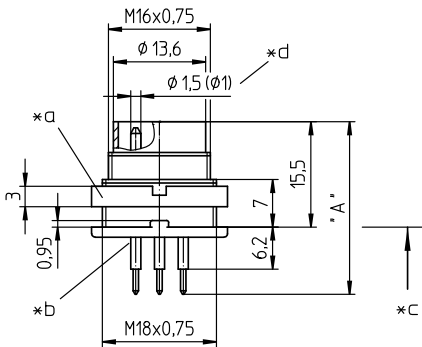
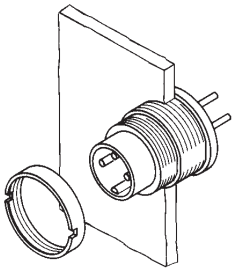

Environmental conditions

Temperature range -40 °C/+85 °C

Materials

Insulating body PA GF, V-0 according to UL94
 Contact pin CuZn, silver-plated and flash gold-plated, tin-plated in solder area (3-8 poles)
 CuZn, pre-nickel and gold-plated, tin-plated in solder area (12 poles)
 Housing Zn diecast, pre-copper and nickel-plated
 Ring screw CuZn, nickel-plated

Mechanical data

Tightening torque connector 1-3 Nm
 Tightening torque nut 1-3 Nm
 Protection class IP40¹

¹ according to IEC DIN EN 60529, only in locked condition with an appropriate counterpart

Electrical data (at T_{amb} 20 °C)

Rated current 5 A (T_{amb} 40 °C, 3-8 poles)
 3 A (T_{amb} 40 °C, 12 poles)
 Rated voltage with pollution degree 1:
 300 V (versions 30, 40, 50/6, 60, 70)
 100 V (versions 50, 71, 80, 81)
 160 V (Polbild 120)
 with pollution degree 2:
 250 V (versions 30, 40)
 32 V (versions 50, 71, 80, 81)
 160 V (versions 50/6, 60, 70, 120)
 Rated impulse voltage 1500 V (versions 30, 40, 50/6, 60, 70, 120)
 500 V (versions 50, 71, 80, 81)
 Material group II (IEC)/I (UL) (400 ≤ CTI < 600)
 Overvoltage category I
 Insulation resistance > 100 MΩ

Associated products

Counterparts
 ☞ KV ☞ KV ...-8 ☞ WKV
 Accessories
 ☞ 0383 ☞ 038399 ☞ 0384
 ☞ 038899

03 SGR

Pin configurations, solder side view

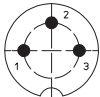

03-a
SGR 30



04-a
SGR 40



05-b
SGR 50



05-a
SGR 50/6

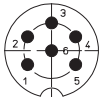

06-a
SGR 60



07-a
SGR 70



07-b
SGR 71



SGR 80

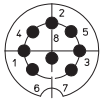

08-a
SGR 81



12-a
SGR 120

03 SGR

Printed circuit board layout, solder side view

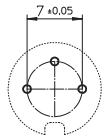

03-a
SGR 30

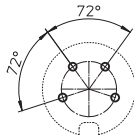

04-a
SGR 40

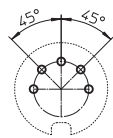

05-b
SGR 50

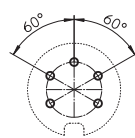

05-a
SGR 50/6

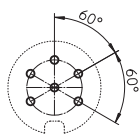

06-a
SGR 60

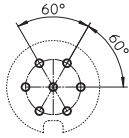

07-a
SGR 70

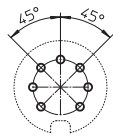

07-b
SGR 71

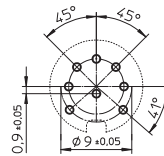

SGR 80

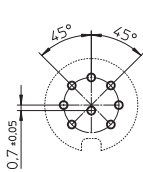

08-a
SGR 81

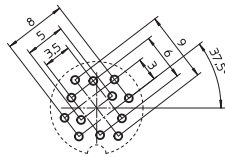

12-a
SGR 120

- *a nut enclosed separately
- *b for bore hole of printed circuit board
Ø 1.0 mm (SGR 30–81)
Ø 0.7 mm (SGR 120)
- *c mounting direction
- *d 12 pole version Ø 1.0 mm
- *e port in mounting plate

03 SGR

Designation	Pole Number	PU (Pieces)	MDQ (Pieces)	Dimensions A (mm)
SGR 30	3	50	100	25.4
SGR 40	4	50	100	25.4
SGR 50	5	50	100	25.4
SGR 50/6	5	50	100	25.4
SGR 60	6	50	100	25.4
SGR 70	7	50	100	25.4
SGR 71	7	50	100	25.4
SGR 80	8	50	100	25.4
SGR 81	8	50	100	25.4
SGR 120	12	50	100	24.8

Packaging:
in a cardboard box