

KEMET, Z-PMS, Ferrite Beads, Noise Suppression, 50 mOhms

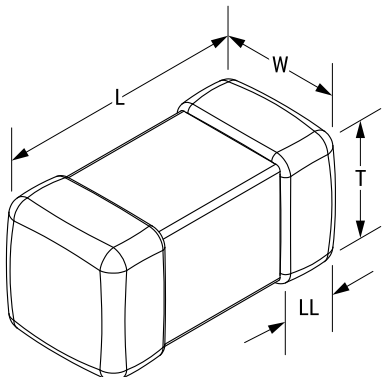

Dimensions	
Chip Size	0402
L	1mm +/-0.05mm
W	0.5mm +/-0.05mm
T	0.5mm +/-0.05mm
B	0.25mm +/-0.1mm

Packaging Specifications	
Packaging:	T&R
Packaging Quantity:	10000

General Information	
Series:	Z-PMS
Style:	SMD Chip
Description:	Chip Bead, Power Line
Features:	Suppresses The XL Component; Helps Stop The Reduction Of The Wave-Form Integrity
RoHS:	Yes

Specifications	
Impedance:	33 Ohms (100 mHz)
Impedance Tolerance:	25%
Ripple Current:	1700 mA (MAX)
Temperature Range:	-55/+85°C
Resistance:	0.05 Ohms