

Digital Controller

E5CK

Advanced, Compact Digital Controllers

- IP66/NEMA4 (indoor use) front face.
- Modular structure, one-stock type.
- Heat/Cool control.
- Serial communications (RS-232C and RS-485).
- Temperature and analog inputs.
- High-accuracy: 100 ms sampling (for analog input).
- Advanced tuning which includes fuzzy self-tuning.
- Conforms to international EMC and safety standards.
- AC/DC24V types are also available.



Ordering Information

Description	Model	Specification
Base Unit	E5CK-AA1 AC100-240	Base Unit
	E5CK-AA1-500 AC100-240	Base Unit with terminal cover
	E5CK-AA1 AC/DC24	Base Unit
	E5CK-AA1-500 AC/DC24	Base Unit with terminal cover

Note: A single Output Unit and Option Unit can be mounted to each Base Unit.

Description	Model	Specification
Output Unit	E53-R4R4	Relay/Relay
	E53-Q4R4	Pulse (NPN)/Relay
	E53-Q4HR4	Pulse (PNP)/Relay
	E53-C4R4	Linear (4 to 20 mA)/Relay
	E53-C4DR4	Linear (0 to 20 mA)/Relay
	E53-V44R4	Linear (0 to 10 V)/Relay
	E53-Q4Q4	Pulse (NPN)/Pulse (NPN)
	E53-Q4HQ4H	Pulse (PNP)/Pulse (PNP)

Description	Model	Specification
Option Unit	E53-CK01	RS-232C
	E53-CK03	RS-485
	E53-CKB	Event input: 1 point
	E53-CKF	Transfer output (4 to 20 mA)

Inspection Report

The Digital Controller can be provided together with an inspection report.

Refer to the following legend with the suffix "K" when ordering a model provided together with an inspection report.

E5CK-AA1-K, E53-CKF-K

■ Accessories (Order Separately)

Name	Model
Terminal Cover	E53-COV07

■ Temperature Ranges

Platinum Resistance Thermometer

Input (switch selectable)		JPt100	Pt100
Range	°C	199.9 to 650.0	199.9 to 650.0
	°F	199.9 to 999.9	199.9 to 999.9
Resolution (°C/°F) (main setting and alarm)		0	1

Thermocouple

Input (switch selectable) (see note)		K1	K2	J1	J2	T	E	L1	L2	U	N	R	S	B	W	PL II
Range	°C	200 to 1,300	0.0 to 500.0	100 to 850	0.0 to 400.0	199.9 to 400.0	0 to 600	100 to 850	0.0 to 400.0	199.9 to 400.0	200 to 1,300	0 to 1,700	0 to 1,700	100 to 1,800	0 to 2,300	0 to 1,300
	°F	300 to 2,300	0.0 to 900.0	100 to 1,500	0.0 to 750.0	199.9 to 700.0	0 to 1,100	100 to 1,500	0.0 to 750.0	199.9 to 700.0	300 to 2,300	0 to 3,000	0 to 3,000	300 to 3,200	0 to 4,100	0 to 2,300
Resolution (°C/°F) (main setting and alarm)		2	3	4	5	6	7	8	9	10	11	12	13	14	15	16

Note: Setting number is factory-set to 2 (K1).
Thermocouple W is W/Re 5-26 (tungsten rhenium 5, tungsten rhenium 26).

Current/Voltage

Input (switch selectable)	Current input		Voltage input		
	4 to 20 mA	0 to 20 mA	1 to 5 V	0 to 5 V	0 to 10 V
Range	One of following ranges depending on results of scaling 1999 to 9999 199.9 to 999.9 19.99 to 99.99 1.999 to 9.999				
Resolution (°C/°F) (main setting and alarm)	17	18	19	20	21

■ Model Number Legend

Refer to the following when ordering set models.

E5CK- j j j
1 2 3

- | | |
|---|--|
| <p>1. Control Output 1/Control Output 2</p> <p>AA: Without Output Unit (field interchangeable)</p> <p>RR: Relay/Relay</p> <p>QR: Pulse (NPN)/Relay</p> <p>CR: Linear (4 to 20 mA)/Relay</p> <p>VR: Linear (0 to 10 V)/Relay</p> <p>QQ: Pulse (NPN)/Pulse (NPN)</p> | <p>2. Auxiliary Output</p> <p>1: Auxiliary output (1 point)</p> <p>3. Option</p> <p>01: RS-232C serial communication</p> <p>03: RS-485 serial communication</p> <p>B: Event input (1 point)</p> <p>F: Transfer output (4 to 20 mA)</p> |
|---|--|

Note: E5CK-VR1 and E5CK-QQ1 are not available, but with options.

Specifications

■ Ratings

Item	AC100-240V type	AC/DC24V type
Supply voltage	AC100 240V~, 50/60 Hz	AC/DC24V~, 50/60 Hz
Power consumption	15 VA	6 VA, 3.5 W
Operating voltage range	85% to 110% of rated supply voltage	
Input	Thermocouple: K, J, T, E, L, U, N, R, S, B, W, PLII Platinum resistance thermometer: JPt100, Pt100 Current input: 4 to 20 mA, 0 to 20 mA Voltage input: 1 to 5 V, 0 to 5 V, 1 to 10 V	
Input impedance	Current input: 150 Ω Voltage input: 1 M Ω min.	
Control output	According to Output Unit (see "Output Unit Ratings and Characteristics")	
Auxiliary output	SPST-NO, 1 A at 250 VAC (resistive load)	
Control method	ON/OFF or advanced PID control	
Setting method	Digital setting using front panel keys	
Indication method	7-segment digital display and LEDs	
Other functions	According to Option Unit (see "Option Unit Ratings and Characteristics")	

■ Characteristics

Indication accuracy (see note)	Thermocouple: ($\pm 0.3\%$ of indication value or $\pm 1^\circ\text{C}$, whichever greater) 1 digit max. Platinum resistance thermometer: ($\pm 0.2\%$ of indication value or 0.8°C , whichever greater) 1 digit max. Analog input: $\pm 0.2\%$ FS ± 1 digit max.
Hysteresis	0.01% to 99.99% FS (in units of 0.01% FS)
Proportional band (P)	0.1% to 999.9% FS (in units of 0.1% FS)
Integral (reset) time (I)	0 to 3,999 s (in units of 1 s)
Derivative (rate) time (D)	0 to 3,999 s (in units of 1 s)
Control period	1 to 99 s (in units of 1 s)
Manual reset value	0.0% to 100.0% (in units of 0.1%)
Alarm setting range	1,999 to 9,999 or 199.9 or 999.9 (decimal point position dependent on input type)
Sampling period	Temperature input: 250 ms Analog input: 100 ms
Insulation resistance	20 M Ω min. (at 500 VDC)
Dielectric strength	2,000 VAC, 50/60 Hz for 1 min between terminals of different polarities
Vibration resistance	Malfunction: 10 to 55 Hz, 10 m/s ² (approx. 1G) for 10 min each in X, Y, and Z directions Destruction: 10 to 55 Hz, 20 m/s ² (approx. 2G) for 2 hrs each in X, Y, and Z directions
Shock resistance	Malfunction: 200 m/s ² min. (approx. 20G), 3 times each in 6 directions (100 m/s ² (approx. 10G) applied to the relay) Destruction: 300 m/s ² min. (30G), 3 times each in 6 directions
Ambient temperature	Operating: 10°C to 55°C (with no icing)/3-year warranty period: 10°C to 50°C Storage: 25°C to 65°C (with no icing)
Ambient humidity	Operating: 35% to 85%
Enclosure ratings	Front panel: NEMA4 for indoor use (equivalent to IP66) Rear case: IEC standard IP20 Terminals: IEC standard IP00
Memory protection	Non-volatile memory (number of writings: 100,000 operations)
Weight	Approx. 170 g; Adapter: approx. 10 g
EMC	Emission Enclosure: EN55011 Group 1 class A Emission AC Mains: EN55011 Group 1 class A Immunity ESD: EN61000-4-2: 4kV contact discharge (level 2) 8kV air discharge (level 3) Immunity RF-interference: ENV50140: 10V/m (amplitude modulated, 80 MHz to 1 GHz) (level 3) 10 V/m (pulse modulated, 900 MHz) Immunity Conducted Disturbance: ENV50141: 10V (0.15 to 80 MHz) (level 3) Immunity Burst: EN61000-4-4: 2kV power-line (level 3) 2kV I/O signal-line (level 4)
Approved standards	UL1092, CSA22.2 No. 14, CSA22.2 No. 1010-1 Conforms to EN50081-2, EN50082-2, EN61010-1 (IEC1010-1) Conforms to VDE0106/ part 100 (Finger Protection), when the separately-ordered terminal cover is mounted.

Note: The indication accuracy of the K1, T, and N thermocouples at a temperature of -100°C or less is $\pm 2^\circ\text{C} \pm 1$ digit maximum. The indication accuracy of the U, L1, and L2 thermocouples at any temperature is $\pm 2^\circ\text{C} \pm 1$ digit maximum.
The indication accuracy of the B thermocouple at a temperature of 400°C or less is unrestricted.
The indication accuracy of the R and S thermocouples at a temperature of 200°C or less is $\pm 3^\circ\text{C} \pm 1$ digit maximum.
The indication accuracy of the W thermocouple at any temperature is (0.3% of the indicated value or $\pm 3^\circ\text{C}$, whichever is greater) 1 digit maximum.
The indication accuracy of the PLII thermocouple at any temperature is ($\pm 0.3\%$ or $\pm 2^\circ\text{C}$, whichever is greater) 1 digit maximum.

■ Output Unit Ratings and Characteristics

Relay output	SPST, 250 VAC, 3 A (resistive load) Mechanical life expectancy: 10,000,000 operations min. Electrical life expectancy: 100,000 operations min.
Voltage output	NPN: 20 mA at 12 VDC (with short-circuit protection) PNP: 20 mA at 12 VDC (with short-circuit protection)
Linear voltage output	0 to 10 VDC: Permissible load impedance: 1 k Ω min. Resolution: approx. 2,600
Linear current output	4 to 20 mA: Permissible load impedance: 500 Ω max. Resolution: approx. 2,600

■ Option Unit Ratings and Characteristics

Event inputs	Contact input: ON: 1 k Ω max., OFF: 100 k Ω min. No-contact input: ON: residual voltage 1.5 V max., OFF: leakage current 0.1 mA max.
Communications	Interface: RS-232C or RS-485 Transmission method: Half-duplex Synchronization method: Start-stop synchronization (asynchronous method) Baud rate: 1.2/2.4/4.8/9.6/19.2 kbps
Transfer output	4 to 20 mA: Permissible load impedance: 500 Ω max. Resolution: approx. 2,600

Nomenclature

Operation Indicators

OUT1

Lit when the pulse output function assigned to control output 1 turns ON.

OUT2

Lit when the pulse output function assigned to control output 2 turns ON.

SUB1

Lit when the output function assigned to auxiliary output 1 turns ON.

MANU

Lit when the manual operation mode.

STOP

Lit during operation has stopped.

RMT

Lit during remote operation.

AT

Flashes during auto-tuning.

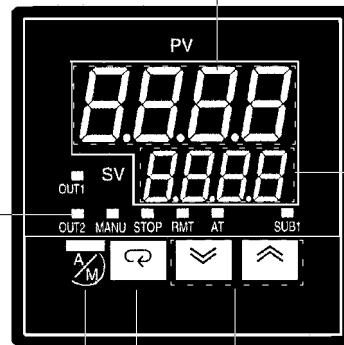

No. 1 Display

Displays the process value or parameter symbols.

No. 2 Display

Displays the set point, set point during SP ramp, manipulated variable, or parameter settings.

Up Key/Down Key

Press to increase or decrease the value on the No.2 display.

Display Key

Press for less than 1 s to shift the display to the next parameter. When this key is pressed for 1 s or more, the menu screen will be displayed in any case.

A/M Key

Press to select the auto operation or manual operation.

Operation

Parameter Operation List

Switching to modes other than manual or protect mode is carried out using mode selection in the menu display.

The figure below shows all parameters in the order that they are displayed. Some parameters are not displayed depending on the protect mode setting and conditions of use.

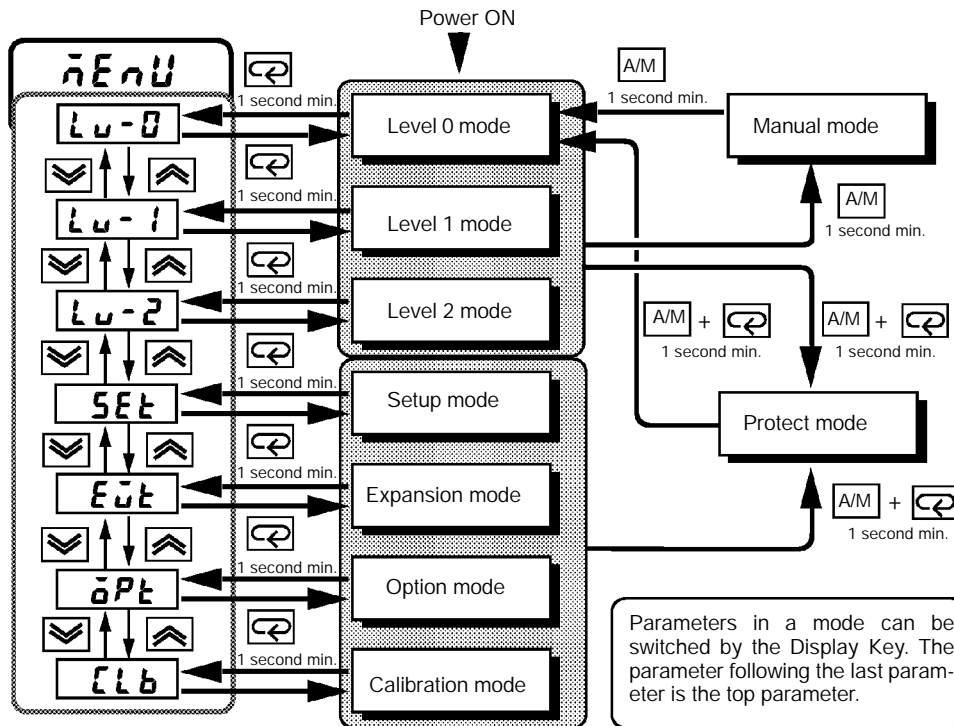

Parameters and Menus

Note: For more details on the functions of each part and display contents, refer to the *E5CK User's Manual (H78)*.

- Protect Mode** Limits use of the menu and A/M Keys. The protect function prevents unwanted modification of parameters and switching between the auto and manual operation.
- Manual Mode** The Controller can be switched to manual operation. The manipulated variable can be manipulated manually only in this mode.
- Level 0 Mode** Set the Controller to this mode during normal operation. In this mode, change the set point during operation, and start or stop Controller operation. The process value, ramp SP, and manipulated variable can only be monitored in this mode.
- Level 1 Mode** The main mode for adjusting control. In this mode, execute AT (auto-tuning), and set alarm values, the control period, and PID parameters.
- Level 2 Mode** The auxiliary mode for adjusting control. In this mode, set the parameters for limiting the manipulated variable and set point, switch between the remote and local modes, and set the loop break alarm (LBA), alarm hysteresis, and the digital filter value of inputs.
- Setup Mode** The mode for setting the basic specifications. In this mode, set parameters that must be checked or set before operation such as the input type, scaling, output assignments and direct/reverse operation.
- Expansion Mode** The mode for setting expanded functions. In this mode, set ST (self-tuning), SP setting limiter, select advanced PID or ON/OFF control, specify the standby sequence resetting method, initialize parameters, and set the time for automatic return to the monitoring display.
- Option Mode** The mode for setting option functions. Select this mode only when the Option Unit is set in the Controller. In this mode, set the communications conditions, transfer output and event input parameters to match the type of Option Unit set in the Controller.
- Calibration Mode** The mode for calibrating inputs and transfer output. When calibrating input, the selected input type is calibrated. Whereas, transfer output can be calibrated only when the Communications Unit (E53-CKF) is set in the Controller.

■ Parameters Operation

Level 0 Mode

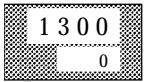

PV/SV

The process value is displayed on the No.1 display and the set point is displayed on the No.2 display. When the multi-SP function is in use, the value of whichever is set, set point 0 or 1, is linked.

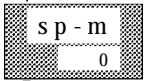

Set Point During SP Ramp

Monitors the set point when the SP ramp function is used.

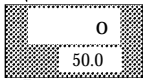

MV Monitor (Heat)

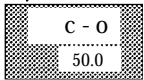

MV Monitor (Cool)

Used when the Unit is in heating and cooling control operation.

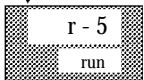

Run/Stop



Security

Any mode marked with "X" in the following table is not displayed on the menu when this parameter is set to "0" to "3."

Mode	Set value				
	0	1	2	3	4
Calibration		X	X	X	X
Option			X	X	X
Expansion			X	X	X
Setup			X	X	X
Level 2				X	X
Level 1, 0					X

The Unit will be in only level 0 mode and the menu will not be available when this parameter is set to "4" to "6."

Only the "PV/SP monitor" and "set point" parameter can be used when this parameter is set to "5."

Only the "PV/SP monitor" parameter can be used when this parameter is set to "6."

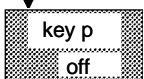

A/M Key Protect

Invalidate the function of the A/M Key.

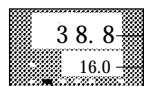

MV Manual

Process value
Manipulated variable
MANU indicator

Level 1 Mode

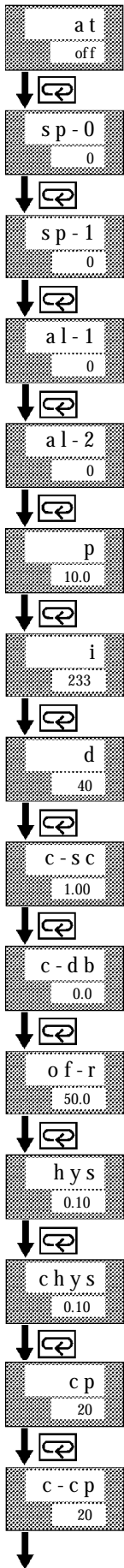

AT Execute/Cancel

Set Point 0

Used with multi-SP function.

Set Point 1

Used with multi-SP function.

Alarm Value 1

Available only when the alarm output function of the Controller is selected.

Alarm Value 2

Available only when the alarm output function of the Controller is selected.

Proportional Band

Integral Time

Derivative Time

Cooling Coefficient

Used when the Controller is in heating and cooling control.

Dead Band

Used when the Controller is in heating and cooling control.

Manual Reset Value

Available when the integral time parameter of the Controller in standard control is "0."

Hysteresis (Heat)

Available when the Controller is in ON/OFF control.

Hysteresis (Cool)

Available when the Controller is in ON/OFF control in heating and cooling control.





Control Period (Heat)

Available when the Controller has a relay or voltage output, or is in advanced PID control.

Control Period (Cool)

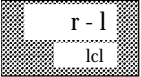
Available when the Controller has a relay or voltage output, or is in advanced PID control in heating and cooling control.

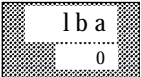
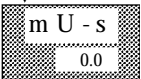
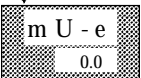
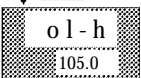
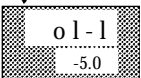
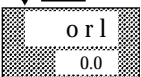
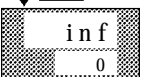
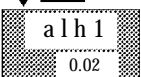
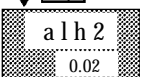
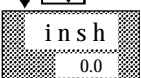
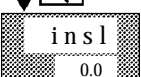
Level 2 Mode

	Remote/Local Used for the communications function.
	SP Ramp Time Unit
	SP Ramp Set Value
	LBA Detection Time Available only when the LBA (loop break alarm) function of the Controller is selected.
	MV at Stop
	MV at PV Error
	MV Upper Limit
	MV Lower Limit
	MV Change Rate Limit
	Input Digital Filter
	Alarm 1 Hysteresis Available only when the Controller has an alarm output.
	Alarm 2 Hysteresis Available only when the Controller has an alarm output.
	Input Shift Upper Limit Available if the input type connected to the Controller is a thermocouple or platinum resistance thermometer.
	Input Shift Lower Limit Available if the input type connected to the Controller is a thermocouple or platinum resistance thermometer.
	

Setup Mode

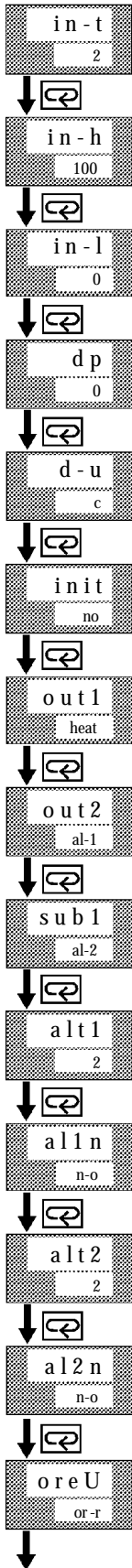

Input Type

Codes are used to determine the input types connected to terminals 6 to 8.

Scaling Upper Limit

Used if the input type connected to the Controller is an analog input (voltage or current input).

Scaling Lower Limit

Used if the input type connected to the Controller is an analog input (voltage or current input).

Decimal Point

Used if the input type connected to the Controller is an analog input (voltage or current input).

°C/°F Selection

Used if the input type connected to the Controller is a temperature input (thermocouple or platinum resistance thermometer).

Parameter Initialize

Control Output 1 Assignment

Enables the Controller to have heating control, cooling control, alarm 1, alarm 2, alarm 3, and LBA (loop break alarm) outputs.

Control Output 2 Assignment

Enables the Controller to have heating control, cooling control, alarm 1, alarm 2, alarm 3, and LBA (loop break alarm) outputs.

Auxiliary Output 1 Assignment

Enables the Controller to have alarm 1, alarm 2, alarm 3, LBA (loop break alarm), error 1, and error 2 outputs.

Alarm 1 Type

Available only when the Controller has an alarm output (see the table on the next page).

Alarm 1 Open in Alarm

Alarm 2 Type

Alarm 2 Open in Alarm

Direct/Reverse Operation

Switch setting	Alarm operation	Alarm output	
		When X is positive	When X is negative
1	Upper- and lower-limit alarm (deviation)		Always ON
2	Upper-limit alarm (deviation)		
3	Lower-limit alarm (deviation)		
4	Upper- and lower-limit range alarm (deviation)		Always OFF
5	Upper- and lower-limit alarm with standby sequence (deviation)		Always OFF
6	Upper-limit alarm with standby sequence (deviation)		
7	Lower-limit alarm with standby sequence (deviation)		
8	Absolute-value upper-limit alarm		
9	Absolute-value lower-limit alarm		
10	Absolute-value upper-limit alarm with standby sequence		
11	Absolute-value lower-limit alarm with standby sequence		

Expansion Mode

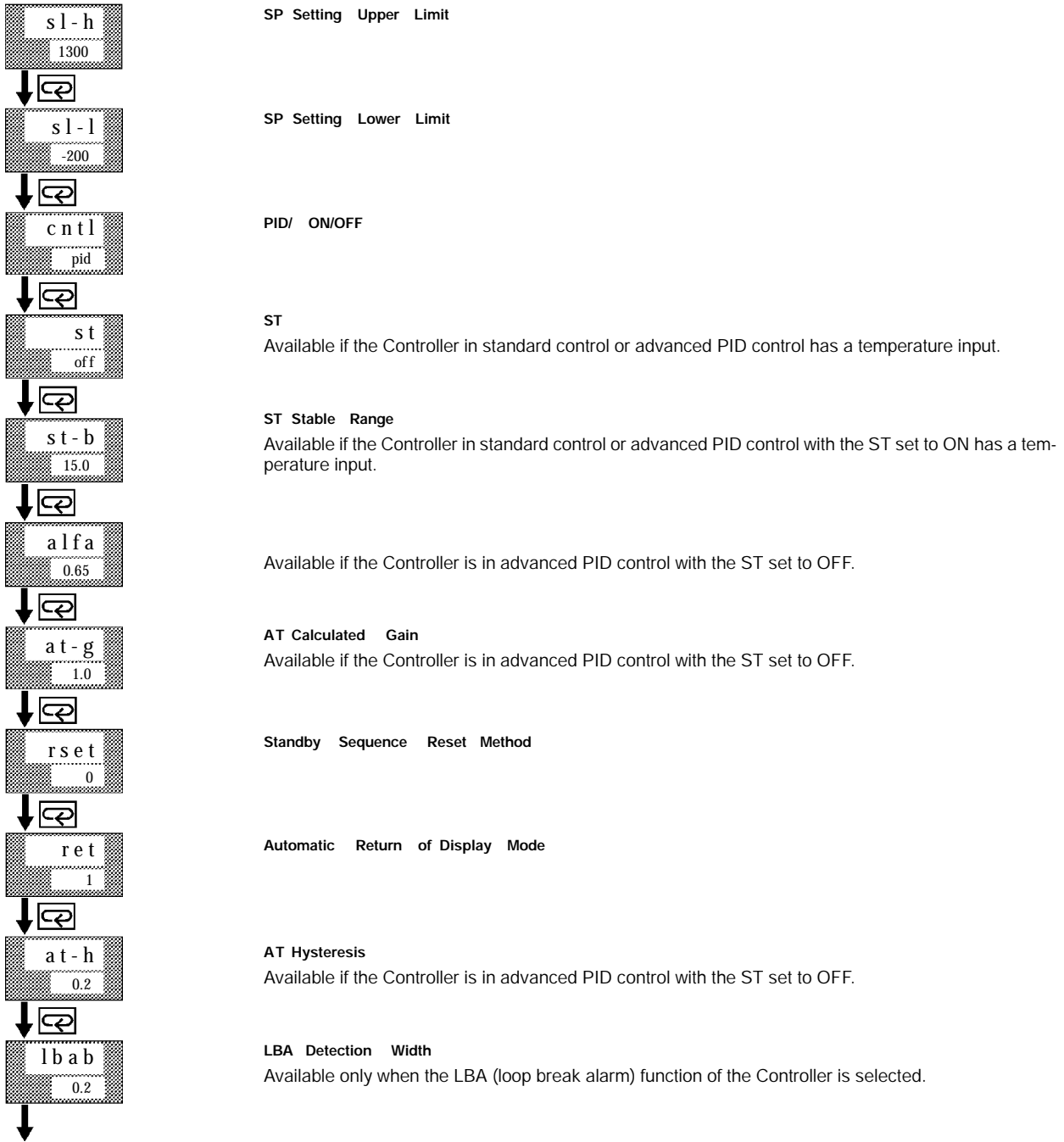

Option Mode

eU - m
0



eU - 1
stop



sbit
2



len
7



prty
eUe



bps
96



u - no
0



tr - t
sp



tr - h
1300



tr - l
-200

**Multi-SP Function**

Available for the event input function.

Event Input Assignment 1

Available for the event input function.

Communication Stop Bit

Used when the communications function is being used.

Communication Data Length

Used when the communications function is being used.

Communication Parity

Used when the communications function is being used.

Communication Baud Rate

Used when the communications function is being used.

Communication Unit No.

Used when the communications function is being used.

Transfer Output Type

Set when the transfer output function is being used.

Transfer Output Upper Limit

Set when the transfer output function is being used.

Transfer Output Lower Limit

Set when the transfer output function is being used.

■ How to Use the Error Display

When an error has occurred, the No.1 display alternately indicates error codes together with the current display item.

This section describes how to check error codes on the display, and the actions that must be taken to remedy the problem.

Input Error

Meaning	Input is in error.
Action	Check the wiring of inputs, disconnections, and shorts, and check the input type and the input type jumper connector.
Operation at Error	For control output functions, output the manipulated variable matched to the setting of the "MV at PV error" parameter (level 2 mode). Alarm output functions are activated when the upper limit is exceeded.

Memory Error

Meaning	Internal memory operation is in error
Action	First, turn the power OFF then back ON again. If the display remains the same, the E5CK Controller must be repaired. If the display is restored to normal, the probable cause may be external noise affecting the control system. Check for external noise.
Operation at Error	Control output functions turn OFF (2 mA max. at 4 to 20 mA output, and output equivalent to 0% in case of other outputs). Alarm output functions turn OFF.

A/D Converter Error

Meaning	Internal circuits are in error.
Action	First, turn the power OFF then back ON again. If the display remains the same, the E5CK Controller must be repaired. If the display is restored to normal, the probable cause may be external noise affecting the control system. Check for external noise.
Operation at Error	Control output functions turn OFF (2 mA max. at 4 to 20 mA output, and output equivalent to 0% in case of other outputs). Alarm output functions turn OFF.

Calibration Data Error

	This error is output only during temperature input and is displayed for two seconds when the power is turned ON.
Meaning	Calibration data is in error.
Action	Must repair.
Operation at Error	Both control output functions and alarm output functions are active. However, note that the readout accuracy is not assured.

Display Range Over

Meaning	Though not an error, this is displayed when the process value exceeds the display range when the control range (setting range 10%) is larger than the display range (1999 to 9999). When less than "1999" When greater than "9999"
Operation	Control continues, allowing normal operation.

■ Fuzzy Self-tuning

Fuzzy self-tuning is a function that enables the E5CK to calculate the most suitable PID constants for the controlled object.

Features

The E5CK determines by itself when to perform fuzzy self-tuning.

Fuzzy Self-tuning Function

The fuzzy self-tuning function has three modes.

In SRT (step response tuning) mode, the PID constants are tuned using a step response method at the time the set point is changed.

In DT (disturbance tuning) mode, the PID constants are amended so that the controlled temperature will be within the target range set in advance when there is external disturbance.

In HT (hunting tuning) mode, when hunting occurs, the PID constants are amended to suppress the hunting.

Note: Be sure to turn on the power supply to the load either before or simultaneously with the start of Temperature Controller operation.

Dead time will be measured from the time the Temperature Controller starts operating. If a load such as a heater is turned on after the Temperature Controller is turned on, dead time longer than the actual value will be measured and inappropriate PID constants will be obtained. If an extremely large amount of dead time is measured, the control amount will be set to 0% for a short period of time before being returned to 100%, and the constants will then be re-tuned. Retuning is performed only for large amounts of dead time, so be sure to follow the precaution given above when starting operation.

Startup Conditions of SRT

SRT will start if the following conditions are satisfied simultaneously when the E5CK is turned on or the set point is changed.

At the time the E5CK starts operating	At the time set point is changed
<ol style="list-style-type: none"> The set point at the time the E5CK starts operating is different from the set point used at the time SRT was last executed (see note). The process value at the time the E5CK starts operating is smaller than the set point in reverse operation and larger than the set point in normal operation. 	<ol style="list-style-type: none"> The new set point is different from the set point used at the time SRT was last executed (see note). The process value is in stable condition before the set point is changed. A larger set point value is set in reverse operation and a smaller set point is set in normal operation.

Note: The last SRT-executed set point is set to 0 before shipping and when changing from advanced PID control to advanced PID control with fuzzy self-tuning.

PID Constant Refreshing Conditions

If the step control amount is applied before the maximum temperature slope (R) is obtained, SRT will not renew any PID constant. If the proportional band obtained from the R and L values that were measured before the imposition had been completed is larger than the present proportional band, the PID constants will be renewed because the measured value is in the direction towards the suitable proportional band value, and the set point at that time will be the SRT-executed set point.

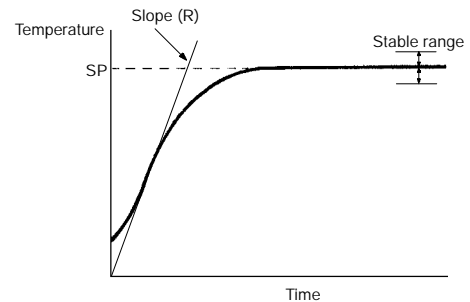

Stable Temperature Status

If the temperature is within the stable range for a certain time, it is deemed that the temperature is stable. This time is called stability judgement time. Like PID constants, stability judgement time is adjusted with fuzzy self-tuning according to the characteristics of the object to be controlled. Fuzzy self-tuning will not be activated if the temperature is stable because the Temperature Controller deems that temperature control is smooth.

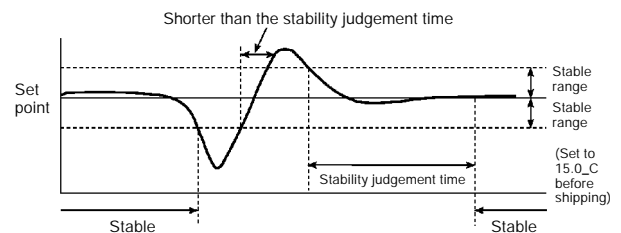

Balanced Status

If the process value is within the stable range for 60 s when there is no output, it is deemed that the the temperature is balanced.

Startup Conditions of DT

- DT will start if the temperature that has been stable varies due to external disturbance and the deflection of the temperature exceeds the stable range, and then the temperature becomes stable, provided that the number of maximum temperature values is less than four.
- DT will start if the set point is changed under the condition that SRT does not start and the temperature becomes stable, provided that the number of maximum temperature values is less than four. If there are four or more maximum temperature values, HT will start.

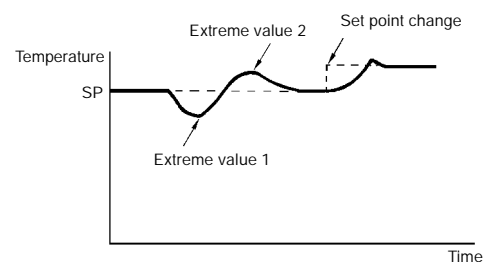

Startup Conditions of HT

HT will be ON when there is hunting with four or more maximum temperature values (extreme values) while SRT is not being executed.

Note: In specific applications where temperature varies periodically due to disturbance, internal parameters need to be adjusted. For details, refer to the *E5CK User's Manual*.

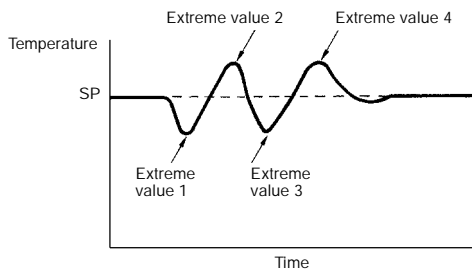

Dimensions

Note: All units are in millimeters unless otherwise indicated.

E5CK

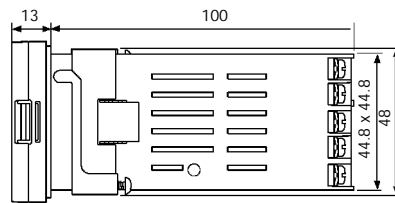
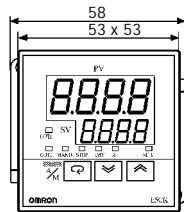
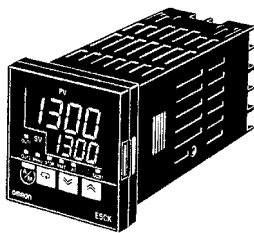

Panel Cutouts

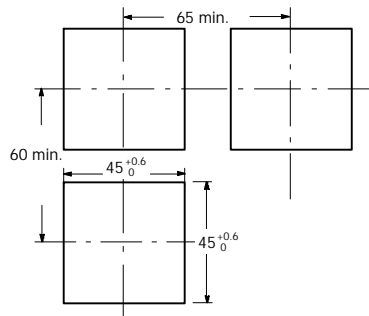

- Note:**
1. Recommended panel thickness is 1 to 5 mm.
 2. Maintain the specified vertical and horizontal mounting space between each Unit. Units must not be closely mounted vertically or horizontally.

Installation

■ Installation

Main Parts

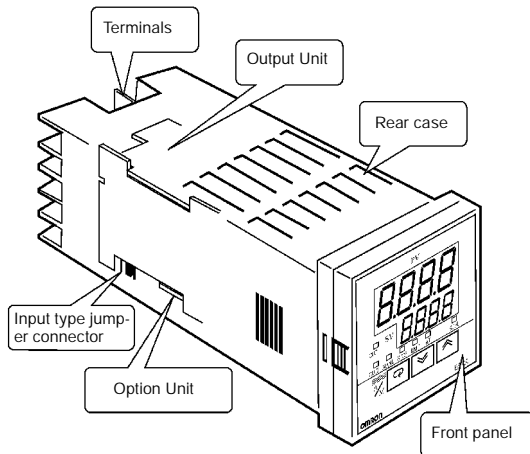

Draw-out

First, draw out the internal mechanism from the housing. Pull out the internal mechanism while pressing the hooks on the left and right sides of the front panel.

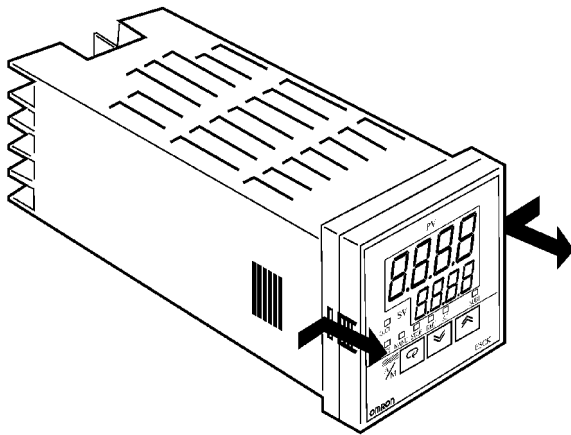

Setting Up the Output Unit

1. Two rectangular holes are provided on the power board (right side of Controller). Fit the two protrusions of the Output Unit into these two holes.
2. With the Output Unit fitted into the power board, fit the Output Unit into the connector on the control board (left side of Controller).

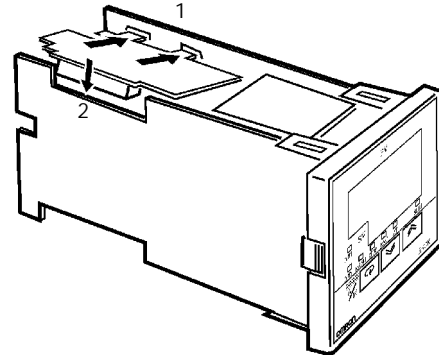

Setting Up the Option Unit

1. Place the Controller with its bottom facing up, and fit the board horizontally into the Connector on the power board (right side of controller).
2. With the power board connected, fit the board vertically into the Connector on the control board (left side of controller).

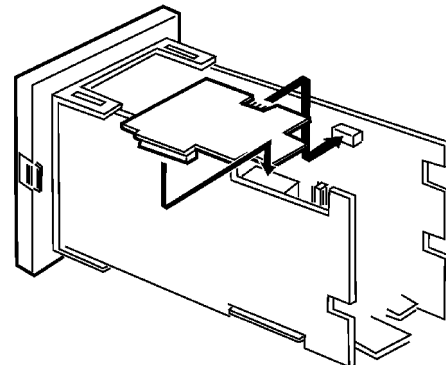

■ Mounting

1. Insert the E5CK Controller into the panel's mounting hole at the position shown in the figure below.
2. Push the adapter along the Controller body from the terminals up to the panel, and fasten temporarily.
3. Tighten the two fixing screws on the adapter. When tightening screws, tighten the two screws alternately keeping the torque to approximately 0.29 to 0.39 N S m, or 3 to 4 kgf S cm.

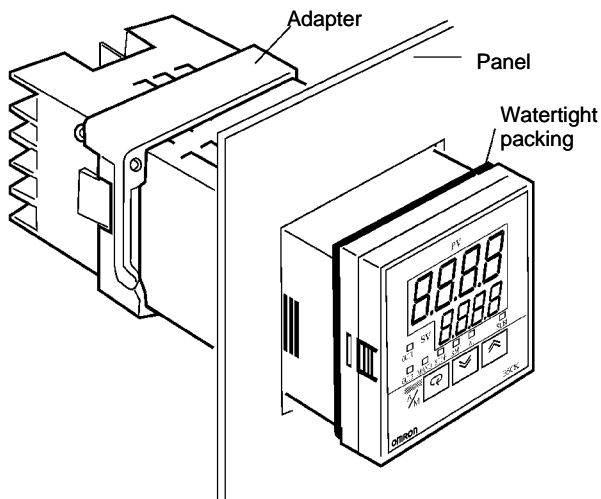

Terminal Cover

The E5CK-AA1-500 Controller is provided with a Terminal Cover (E53-COV07). Fasten the Terminal Cover as follows by using the snap pin.

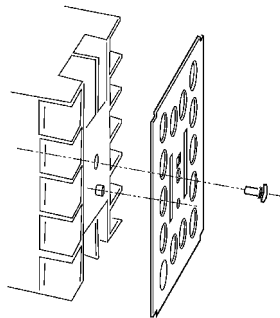

■ Wiring

Terminal Arrangement

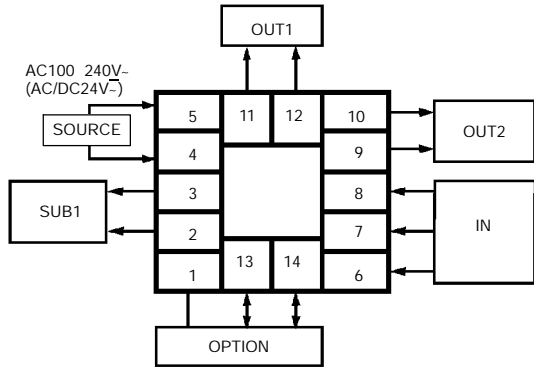

Solderless terminals are recommended when wiring the Controller. Tighten the terminal screws using a torque no greater than 0.78 N S m, or 8 kgf S cm max. Take care not to tighten the terminal screws too tightly.

Power Blocks

The E5CK has independent power supplies for each of the terminal blocks shown below. However, note that the power supplies for blocks C (exclude relay output) and D are shared for the following option unit.

Option unit: E53-CKB or E53-CKF

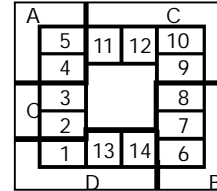

Precautions

Use ducts to separate input leads and power lines in order to protect the Controller and its lines from external noise.

Wiring

Power Supply

Input 100 to 240 VAC or AC/DC 24 V to terminal numbers 4 and 5 according to the specification.

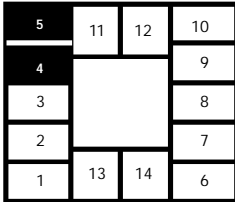

Input

Connect the input to terminal numbers 6 to 8 as follows according to the input type.

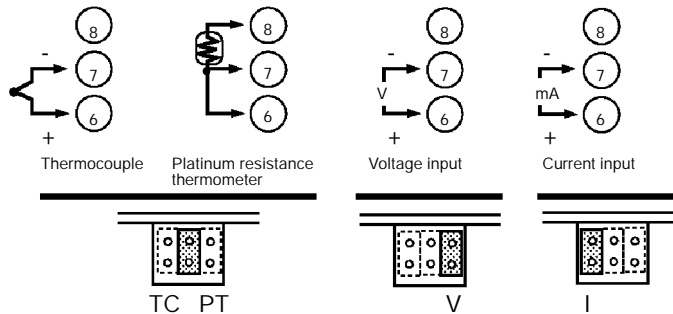
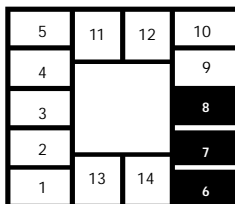

Match the inputs with the internal jumper settings for each input type. For thermocouple or platinum resistance thermometer inputs, set the inputs to a common position (TC/PT) as the temperature input.

Control Output

Terminal numbers 11 and 12 are for control output 1 (OUT1). The five output types and internal equalizing circuits are available according to the Output Unit.

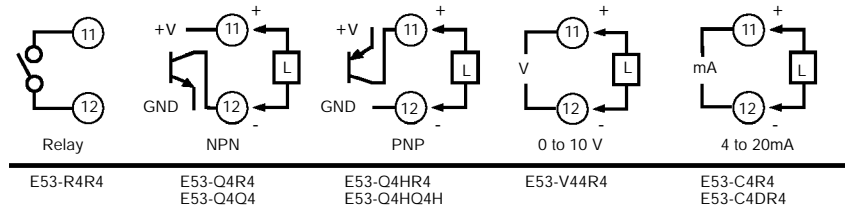
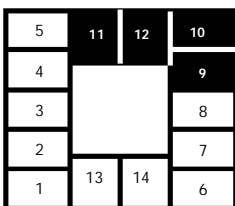

Precautions

■ Period and Scope of Guarantee

Unit with Standard Specifications

Scope of Guarantee

Should the Unit malfunction during the guarantee period, OMRON shall repair the Unit or replace any parts of the Unit at the expense of OMRON.

The above does not apply in the following cases.

1. Any malfunction of the Unit due to the incorrect use or improper handling of the Unit.
2. Any malfunction of the Unit not originating from the Unit.
3. Any malfunction of the Unit due to a modification of the Unit or repairs to the Unit carried out by any person not authorized by OMRON.
4. Any malfunction of the Unit due to any natural disaster.

OMRON shall not be responsible for any damage or loss induced by any malfunction of the Unit.

Three-year Guarantee

Period of Guarantee

The guarantee period of the Unit is three years starting from the date the Unit is shipped from the factory.

Scope of Guarantee

The Unit is guaranteed under the following operating conditions.

1. Average Operating Temperature (see note): 10°C to 50°C
2. Mounting Method: Standard mounting

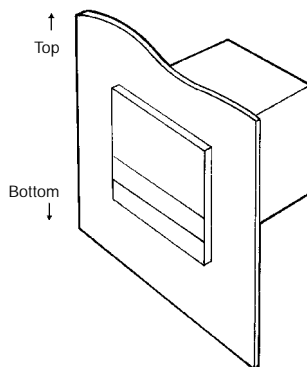

Note: Average Operating Temperature

Refer to the process temperature of the Unit mounted to a control panel and connected to peripheral devices on condition that the Unit is in stable operation, sensor input type K is selected for the Unit, the positive and negative thermocouple input terminals of the Unit are short-circuited, and the ambient temperature is stable.

ALL DIMENSIONS SHOWN ARE IN MILLIMETERS.

To convert millimeters into inches, multiply by 0.03937. To convert grams into ounces, multiply by 0.03527.

Cat. No. H79-E1-4 In the interest of product improvement, specifications are subject to change without notice.

OMRON Corporation

Systems Components Division
28th Fl., Crystal Tower Bldg.
1-2-27, Shiromi, Chuo-ku,
Osaka 540 Japan
Phone: 06-949-6012 Fax: 06-949-6021

Printed in Japan
0297-2M (0995) a