

Contents

Miniature Circuit Breakers (MCB's)	3-2
Protecta Type B Pan Assemblies	3-12
High Performance MCB's.....	3-14
Residual Current Devices	3-19
RCBO's	3-21
Residual Current Relays	3-23
Switch Disconnectors	3-24
Installation Contactors.....	3-25
Latching Relays.....	3-26
Pushbuttons & Indicator Lamps	3-27
Time Switches	3-28
Power Failure Signalling Lamps.....	3-29
Bell Transformers	3-30
Twilight Switches	3-31
Smisline.....	3-32
Surge Protection.....	3-36
Technical Details.....	3-44
Dimensions.....	3-46

[Return to main index](#)

System ProM Overview

Breaking capacities

Short circuit rupturing capacity

Switching sequence acc. to DIN VDE 0641 part 11, EN 60898, IEC 898

Ratings with AC in kA / cos φ, with DC in kA / T ms

Range	Tripping characteristic	Rated current	AC		2/3 phase 230V~ 133/230V~ kA/cos	400V~ 230/400V~ kA/cos	DC ¹⁾ Single Pole up to 60V kA/T ms	Max. Back-up Protection		Max. Short-circuit rupturing capacity of the range								
			1-Phase 133V~ kA/cos	230V~ kA/cos				fuse	Main circuit breaker ²⁾									
S260-B	6	10/0.5	6/0.7	10/0.5	6/0.7	10/4		63A	100A	6000 3								
	10...20							100A	100A									
	25...32							100A	100A									
	40							125A	100A									
	50...63							160A	100A									
S260-C, D	0.5...2	Unlimited						not necessary		unlimited								
	3...4	10/0.5	6/0.7	10/0.5	6/0.7	10/4		20A	-	6000 3								
	6							40A	-									
	8							63A	100A									
	10...20							100A	100A									
	25...32							100A	100A									
	40							125A	100A									
	50...63							160A	100A									
	S270-B							6	10/0.5		6/0.7	10/0.5	6/0.7	10/4		63A	100A	10000 3
								10...20								80A	100A	
25...32								100A								100A		
40		125A	100A															
50...63		160A	100A															
S270-C	0.5...2	Unlimited						not necessary		unlimited								
	3...4	10/0.5	10/0.5	10/0.5	10/0.5	10/4		20A	-	10000 3								
	6							40A	-									
	8							63A	100A									
	10...20							80A	100A									
	25...32							100A	100A									
	40							125A	100A									
50...63	160A							100A										
S270-K	0.5...2	Unlimited						not necessary		unlimited								
	3	10/0.5	6/0.7	10/0.5	6/0.7	10/4		20A	-	6000								
	4							25A	-									
	6...10							63A	100A									
	16...20							80A	100A									
	25...32							100A	100A									
	40							125A	100A									
50...63	160A							100A										
S270-Z	0.5...2	Unlimited						not necessary		unlimited								
	3...4	10/0.5	6/0.7	10/0.5	6/0.7	10/4		20A	-	6000								
	6							35A	100A									
	8							40A	100A									
	10...16							63A	100A									
	20...25							80A	100A									
	32...40							100A	100A									
	50...63							125A	100A									

Return to main index

System ProM Overview

Breaking capacities

Short circuit rupturing capacity

Switching sequence acc. to DINVDE 0641 part 11, EN 60898, IEC 898
Ratings with AC in kA / cos φ, with DC in kA / T ms

Range	Tripping characteristic	AC				DC ¹⁾ Single Pole up to 60V $\overline{\text{---}}$	Max. Back-up Protection		Max. Short-circuit rupturing capacity of the range
		1-Phase 133V~ kA/cos φ	230V~ kA/cos φ	2/3 phase 230V~ 133/230V~ kA/cos φ	400V~ 230/400V~ kA/cos φ		fuse	Main circuit breaker ²⁾	
S280-B	6	15/0.25	10/0.5	15/0.25	10/0.5	10/4	63 A	100 A	up to 25000
	10...13	25/0.25	25/0.25	25/0.25	25/0.25		15/4	80 A	
	16...25					100 A		100 A	
	32...40	20/0.25	15/0.25	20/0.25	15/0.25	125 A	100 A		
	50...63	15/0.25	10/0.25	15/0.25	10/0.5	10/4	160 A	100 A	
S280-C	0.5...2	Unlimited				not necessary		unlimited	
	3, 4	15/0.25	10/0.5	15/0.25	10/0.5	10/4	35 A	-	up to 25000
	6, 8						63 A	100 A	
	10, 13	80 A	100 A						
	16...25	25/0.25	25/0.25	25/0.25	25/0.25	15/4	100 A	100 A	
	32...40	20/0.25	15/0.25	20/0.25	15/0.25	125 A	100 A		
	50...63	15/0.25	10/0.5	15/0.25	10/0.5	10/4	160 A	100 A	
S280-K,Z,D	0.2...2 ³⁾	Unlimited				not necessary		unlimited	
	3	15/0.25	10/0.5	15/0.25	10/0.5	10/4	25 A	-	up to 25000
	4						35 A	-	
	6						63 A	100 A	
	8						80 A	100 A	
	10...20	25/0.25	25/0.25	25/0.25	25/0.25		15/4	100 A	
	25...32	20/0.25	15/0.25	20/0.25	15/0.25	15/4	125 A	100 A	
	40...63	15/0.25	10/0.5	15/0.25	10/0.5	10/4	160 A	100 A	

1) In symmetrical earth-ground AC networks 2 pole MCB's (two poles in series) are applicable up to 100V $\overline{\text{---}}$. In this case the rated rupturing capacity is one step higher than the 1 pole version. Direction of connection is optional.

2) The max. back-up protection is only required if the prospective short circuit current may exceed the short circuit rupturing capacity of the MCB.

3) K from 0.2 A, Z from 0.5 A rated current.

Short Circuit rupturing capacity

Switching sequence according to DINVDE 0660 Part 101, IEC 947.

For the short circuit rupturing capacities listed the time constant $T = L/R$ 15 ms is valid in the case of DC.

In the case of AC for 10kA; cos φ 0.6 – for 8 and 6kA: cos φ 0.8 and for 2kA: cos φ 0.9.

S280 UC	1 pole			2/4 pole				Max. fuse ⁴⁾ for back-up protection: operating class gI (DINVDE 0636/IEC269)
For DC	up to 60V $\overline{\text{---}}$	100V $\overline{\text{---}}$	220V $\overline{\text{---}}$	up to 60V $\overline{\text{---}}$	110V $\overline{\text{---}}$	220V $\overline{\text{---}}$	440V $\overline{\text{---}}$	
For AC	up to 60V ~	127V ~	240V ~	up to 60V ~	127V ~	240V ~	415V ~	
B6 ...25 A	10kA	10kA	6kA	10kA	10kA	10kA	6kA	100A
K, Z 0.2...2 A ⁵⁾	unlimited	unlimited	unlimited	unlimited	unlimited	unlimited	unlimited	not necessary
K, Z 3...4 A	10kA	10kA	6kA	10kA	10kA	10kA	6kA	35A
K, Z 6...8 A	10kA	10kA	6kA	10kA	10kA	10kA	6kA	63A
K, Z 10...32 A	10kA	10kA	6kA	10kA	10kA	10kA	6kA	100A
K, Z 40...63 A	6kA	6kA	4.5kA	10kA	6kA	6kA	4.5kA	125A

4) Back-up protection is only necessary when, at the point of installation the maximum rated short circuit rupturing capacity is expected to be exceeded

5) Z 0.5A...2A

Return to main index

System proM

Miniature Circuit Breakers B, C, and D trip curves.

BS EN 60898. Ratings 0.5 to 100A.

Description, Installation and Task

- Current limiting MCB's with undelayed magnetic and delayed thermal trips, with fixed setting. Metal framed trip-free switching mechanism.

- For installation in ABBProtecta Final Distribution Boards, Pan Assemblies or on symmetrical DIN rail.

- Protection and control of electrical wires, cables and appliances in the case of overcurrent due to overloads and short circuits.

Technical Data

- Current ratings 0.5 to 100A at 30 degrees C to BS EN 60898.

- Rated voltage 230 - 400V AC

- Maximum operating voltage 440V AC, single pole 60V DC, double pole 110V DC.

- Minimum operating voltage 12V AC/DC.

- Breaking capacity: BS EN 60898 - S270B & C 10kA, S260D 6kA, S280B & C 6kA.

- Mechanical service life: 20,000 operations

- Cable capacity: 25mm² up to 40A, 35mm² for 50 and 63A, 50mm² for 80 & 100A.

- Tightening torque: 2Nm up to 63A, 2.5Nm for 80 & 100A.

- Ambient temperature: -25°C to +55°C.

- Weight per pole: 0.125g up to 40A, 0.145g for 50 & 63A, 0.160 for 80 & 100A.

- Dimensions: see page 3/46

- Accessories: see page 3/10, 3/11

- Add on earth leakage: see page 3/20

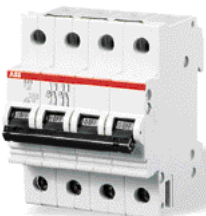
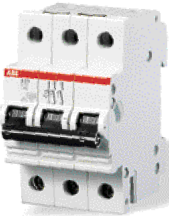

[Return to main index](#)

System proM

Miniature Circuit Breakers B, C, and D trip curves.

BS EN 60898. Ratings 0.5 to 100A.

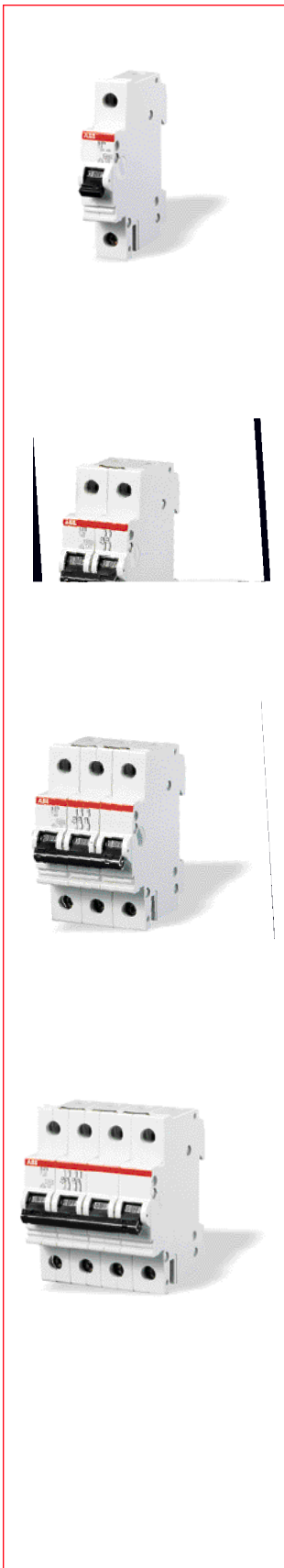

Type B (3-5 In) BS EN 60898.

Small inrush or switching surges, heating loads, tungsten lighting

Rated Current (A)	Breaking Capacity	Single Pole	Double Pole	Triple Pole	Four Pole
6	10kA	S271B6	S272B6	S273B6	S274B6
10	10kA	S271B10	S272B10	S273B10	S274B10
13	10kA	S271B13	S272B13	S273B13	S274B13
16	10kA	S271B16	S272B16	S273B16	S274B16
20	10kA	S271B20	S272B20	S273B20	S274B20
25	10kA	S271B25	S272B25	S273B25	S274B25
32	10kA	S271B32	S272B32	S273B32	S274B32
40	10kA	S271B40	S272B40	S273B40	S274B40
50	10kA	S271B50	S272B50	S273B50	S274B50
63	10kA	S271B63	S272B63	S273B63	S274B63
80	6kA	S281B80	S282B80	S283B80	S284B80
100	6kA	S281B100	S282B100	S283B100	S284B100

Type C (5-10 In) BS EN 60898.

Moderate switching surges for short durations

Rated Current (A)	Breaking Capacity	Single Pole	Double Pole	Triple Pole	Four Pole
0.5	10kA	S271C0.5	S272C0.5	S273C0.5	S274C0.5
1	10kA	S271C1	S272C1	S273C1	S274C1
2	10kA	S271C2	S272C2	S273C2	S274C2
3	10kA	S271C3	S272C3	S273C3	S274C3
4	10kA	S271C4	S272C4	S273C4	S274C4
6	10kA	S271C6	S272C6	S273C6	S274C6
10	10kA	S271C10	S272C10	S273C10	S274C10
13	10kA	S271C13	S272C13	S273C13	S274C13
16	10kA	S271C16	S272C16	S273C16	S274C16
20	10kA	S271C20	S272C20	S273C20	S274C20
25	10kA	S271C25	S272C25	S273C25	S274C25
32	10kA	S271C32	S272C32	S273C32	S274C32
40	10kA	S271C40	S272C40	S273C40	S274C40
50	10kA	S271C50	S272C50	S273C50	S274C50
63	10kA	S271C63	S272C63	S273C63	S274C63
80	6kA	S281C80	S282C80	S283C80	S284C80
100	6kA	S281C100	S282C100	S283C100	S284C100

Type D (10-14 In) BS EN 60898.

High inrush applications

Rated Current (A)	Breaking Capacity	Single Pole	Double Pole	Triple Pole	Four Pole
0.5	6kA	S261D0.5	S262D0.5	S263D0.5	S264D0.5
1	6kA	S261D1	S262D1	S263D1	S264D1
2	6kA	S261D2	S262D2	S263D2	S264D2
3	6kA	S261D3	S262D3	S263D3	S264D3
4	6kA	S261D4	S262D4	S263D4	S264D4
6	6kA	S261D6	S262D6	S263D6	S264D6
10	6kA	S261D10	S262D10	S263D10	S264D10
13	6kA	S261D13	S262D13	S263D13	S264D13
16	6kA	S261D16	S262D16	S263D16	S264D16
20	6kA	S261D20	S262D20	S263D20	S264D20
25	6kA	S261D25	S262D25	S263D25	S264D25
32	6kA	S261D32	S262D32	S263D32	S264D32
40	6kA	S261D40	S262D40	S263D40	S264D40
50	6kA	S261D50	S262D50	S263D50	S264D50
63	6kA	S261D63	S262D63	S263D63	S264D63

[Return to main index](#)

System proM

Miniature Circuit Breakers K tripping curve.

BS EN 60947-2. UL 1077 File No E76126, CSA C22.2 No 235, Report No LR98793-9. (277/480 V).
Ratings 0.2 to 63A.

Description

The K characteristic - the optimal solution for the safe protection of motors.

Motor protection can be achieved by the selection of the MCB with the correct rated current corresponding to the motor data. The electro-magnetic trip is set in such a way that the motor starting current does not lead to tripping. As a result cable sizes can be reduced and more importantly contactors can be used up to their AC3 rating without the need for additional thermal overload protection.

Technical Data

- Current ratings 0.2 to 63A at 20°C to BSEN 60947-2
- Rated voltage 230 - 400V AC
- Maximum operating voltage 440VAC, single pole 60V DC, double pole 110V DC
- Minimum operating voltage 12VAC/DC
- Breaking capacity: BSEN 60947-2 – S270K 6kA, S280K 0.2 - 8A 10kA, 10 to 20A 25kA, 25 to 32A 15kA, 40 to 63A 10kA.
- Mechanical service life: 20,000 operations.
- Cable capacity: S270K 25mm² up to 40A, 35mm² for 50 and 63A, S280K 35mm².
- Tightening torque: 2Nm up to 63A
- Ambient temperature: -25°C to +55°C
- Weight per pole: 0.125g up to 40A, 0.145g for 50 & 63A.
- Accessories: see page 3/10, 3/11
- Add on earth leakage: see page 3/20

Selection rule: (ratings for DOL motors)

The rated current of the K MCB has to be below or equal the rated current of the motor and above the working current of the motor.

Standard Motor KW	[A] at 380 V	[A] at 400V	[In] K-MCB
0,06	0,22	0,2	0,2
0,09	0,33	0,3	0,3
0,12	0,42	0,4	0,3
0,18	0,64	0,6	0,5
0,25	0,88	0,74	0,75/0,5
0,37	1,22	1,1	1
0,55	1,5	1,4	1
0,75	2	2	1,6/2,0
1,1	2,6	2,5	2
1,5	3,5	3,5	3
2,2	5	5	4
3	6,6	6,5	6
4	8,5	8,1	8
5,5	11,5	11	10
7,5	15,5	14,5	16/10
11	22	21	20
15	30	28	25
18,5	37	35	32
22	44	40	40
30	60	55	50
37	72	66	63

[Return to main index](#)

System proM

Miniature Circuit Breakers K tripping curve.

BS EN 60947-2. UL 1077 File No E76126, CSA C22.2 No 235, Report No LR98793-9. (277/480 V).
Ratings 0.2 to 63A.

Type S270K (8-12 In) BS EN 60947-2.

Protection of motors, transformers,
lamps and cable.

Rated Current (A)	Breaking Capacity	Single Pole	Double Pole	Triple Pole	Four Pole
0.5	6kA	S271K0.5	S272K0.5	S273K0.5	S274K0.5
1	6kA	S271K1	S272K1	S273K1	S274K1
1.6	6kA	S271K1.6	S272K1.6	S273K1.6	S274K1.6
2	6kA	S271K2	S272K2	S273K2	S274K2
3	6kA	S271K3	S272K3	S273K3	S274K3
4	6kA	S271K4	S272K4	S273K4	S274K4
6	6kA	S271K6	S272K6	S273K6	S274K6
8	6kA	S271K8	S272K8	S273K8	S274K8
10	6kA	S271K10	S272K10	S273K10	S274K10
16	6kA	S271K16	S272K16	S273K16	S274K16
20	6kA	S271K20	S272K20	S273K20	S274K20
25	6kA	S271K25	S272K25	S273K25	S274K25
32	6kA	S271K32	S272K32	S273K32	S274K32
40	6kA	S271K40	S272K40	S273K40	S274K40
50	6kA	S271K50	S272K50	S273K50	S274K50
63	6kA	S271K63	S272K63	S273K63	S274K63

Type S280K (8-14 In) BS EN 60947-2.

Protection of motors, transformers,
lamps and cable.

Rated Current (A)	Breaking Capacity	Single Pole	Double Pole	Triple Pole	Four Pole
0.2	10kA	S281K0.2	S282K0.2	S283K0.2	S284K0.2
0.3	10kA	S281K0.3	S282K0.3	S283K0.3	S284K0.3
0.5	10kA	S281K0.5	S282K0.5	S283K0.5	S284K0.5
0.75	10kA	S281K0.75	S282K0.75	S283K0.75	S284K0.75
1	10kA	S281K1	S282K1	S283K1	S284K1
1.6	10kA	S281K1.6	S282K1.6	S283K1.6	S284K1.6
2	10kA	S281K2	S282K2	S283K2	S284K2
3	10kA	S281K3	S282K3	S283K3	S284K3
4	10kA	S281K4	S282K4	S283K4	S284K4
6	10kA	S281K6	S282K6	S283K6	S284K6
8	10kA	S281K8	S282K8	S283K8	S284K8
10	25kA	S281K10	S282K10	S283K10	S284K10
13	25kA	S281K13	S282K13	S283K13	S284K13
16	25kA	S281K16	S282K16	S283K16	S284K16
20	25kA	S281K20	S282K20	S283K20	S284K20
25	15kA	S281K25	S282K25	S283K25	S284K25
32	15kA	S281K32	S282K32	S283K32	S284K32
40	10kA	S281K40	S282K40	S283K40	S284K40
50	10kA	S281K50	S282K50	S283K50	S284K50
63	10kA	S281K63	S282K63	S283K63	S284K63

[Return to main index](#)

System proM

Miniature Circuit Breakers UC range (Universal Current).

BS EN 60947-2. UL 1077, File No E76126, CSA C22.2 No 235, Report No LR98793-9.
Ratings 0.5 to 63A.

Description

The S280UC MCB's can be used up to 220V DC for single pole (17.5mm) or up to 440V DC for double pole (35mm) with series connection of 2 poles. This enhanced DC performance is in addition to the AC performance.

They differ from the standard devices in that they are fitted with a permanent magnet which assists in the forced extinguishing of the arc. It is therefore important that care is taken to observe the correct polarity and current flow direction when connecting these breakers.

Technical Data

- Current ratings 0.5 to 63A at 20°C to BSEN 60947-2
- Rated voltage 230 - 400V AC
- Maximum operating voltage 440V AC, single pole 220V DC, double pole 440VDC.
- Minimum operating voltage 12V AC/DC
- Breaking capacity: BS EN 60947-2 – 280UC 0.5 to 32A 6kA, 40 to 63A 4.5kA.
- Mechanical service life: 20,000 operations.
- Cable capacity: S280UC35mm²
- Tightening torque: 2Nm up to 63A
- Ambient temperature: -25°C to + 55°C
- Weight per pole: 0.125g up to 40A, 0.145g for 50 & 63A.
- Accessories: see page 3/10, 3/11

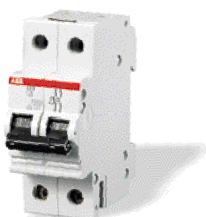

[Return to main index](#)

System proM

Miniature Circuit Breakers UC range (Universal Current).

BS EN 60947-2. UL 1077, File No E76126, CSA C22.2 No 235, Report No LR98793-9.

Ratings 0.5 to 63A.

Type S280UCK (10-14 In) BS EN 60947-2.

Protection of motors, transformers, lamps and cable.



Rated Current InA	Breaking Capacity	Single Pole	Double Pole
0.5	6kA	S281UCK0.5	S282UCK0.5
0.75	6kA	S281UCK0.75	S282UCK0.75
1	6kA	S281UCK1	S282UCK1
1.6	6kA	S281UCK1.6	S282UCK1.6
2	6kA	S281UCK2	S282UCK2
3	6kA	S281UCK3	S282UCK3
4	6kA	S281UCK4	S282UCK4
6	6kA	S281UCK6	S282UCK6
8	6kA	S281UCK8	S282UCK8
10	6kA	S281UCK10	S282UCK10
16	6kA	S281UCK16	S282UCK16
20	6kA	S281UCK20	S282UCK20
25	6kA	S281UCK25	S282UCK25
32	6kA	S281UCK32	S282UCK32
40	4.5kA	S281UCK40	S282UCK40
50	4.5kA	S281UCK50	S282UCK50
63	4.5kA	S281UCK63	S282UCK63

Type S280UCZ (2-3 In) BS EN 60947-2.

Protection of semiconductor devices and voltage transformer circuits

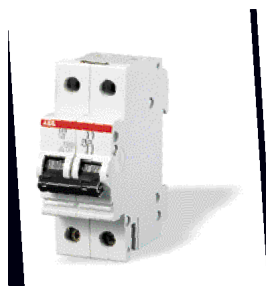

Rated Current InA	Breaking Capacity	Single Pole	Double Pole
0.5	6kA	S281UCZ0.5	S282UCZ0.5
0.75	6kA	S281UCZ0.75	S282UCZ0.75
1	6kA	S281UCZ1	S282UCZ1
1.6	6kA	S281UCZ1.6	S282UCZ1.6
2	6kA	S281UCZ2	S282UCZ2
3	6kA	S281UCZ3	S282UCZ3
4	6kA	S281UCZ4	S282UCZ4
6	6kA	S281UCZ6	S282UCZ6
8	6kA	S281UCZ8	S282UCZ8
10	6kA	S281UCZ10	S282UCZ10
16	6kA	S281UCZ16	S282UCZ16
20	6kA	S281UCZ20	S282UCZ20
25	6kA	S281UCZ25	S282UCZ25
32	6kA	S281UCZ32	S282UCZ32
40	4.5kA	S281UCZ40	S282UCZ40
50	4.5kA	S281UCZ50	S282UCZ50
63	4.5kA	S281UCZ63	S282UCZ63

[Return to main index](#)

System proM

S 260-270-280 series accessories

Electrical Auxiliaries and Accessories

Description	Weight Kg	Order Code
Auxiliary contact		
1 NO + 1 NC	0.040	S2-H11
2 NO	0.040	S2-H20
2 NC	0.040	S2-H02
2 NO + 1 NC	0.050	S2-H21
1 NO + 2 NC	0.050	S2-H12
3 NO	0.050	S2-H30
3 NC	0.050	S2-H03
Signal Contact	0.050	S2-S
Signal and changeover Contact	0.050	S2-S/H
Undervoltage Release		
12V DC	0.070	S2-BM1
24V AC/DC	0.070	S2-BM2
48V AC/DC	0.070	S2-BM3
110V AC/DC	0.070	S2-BM4
220-240V AC / 220V DC	0.070	S2-BM5
380V AC	0.070	S2-BM6
Shunt Trip		
12.....60V AC/DC	0.145	S2-A1
110.....415V AC	0.145	S2-A2
110.....250VDC		
Hand operated neutral		
40A Rated Mounted on R/H side of MCB	0.060	S2-NT
Padlock device		
3mm padlock adapter	0.004	SA1
6mm padlock adapter	0.004	SA1E
Padlock with 2 keys	0.02	SA2
Label carrier (set 100 pieces)	0.1	ST
Label set (300 pieces)	0.1	ST-E

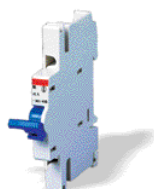
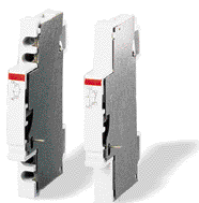

[Return to main index](#)

System proM

S 260-270-280 series Busbars



Busbars

Cross section mm ²	length mm	Poles No.	Weight Kg	Order Code
For single pole MCB's				
12*	988	56 x 1	0.073	SZ-KS1/56
16	1007	56 x 1	0.300	SZ-KS18/56N
36*	988	56 x 1	0.330	SZ-VB45.32

* Uninsulated

For double pole MCB's

16	1035	29 x 2	0.534	SZ-PSB56N (3)
----	------	--------	-------	---------------

For triple pole MCB's

16	1065	20 x 3	0.700	SZ-PSB12N (6)
----	------	--------	-------	---------------

For four pole MCB's

16	1058	15 x 4	0.884	SZ-PSB64N (4)
----	------	--------	-------	---------------

Busbars with aux. contact H... or combined signal contact S/H

Cross section mm ²	length mm	Poles No.	Weight Kg	Order Code
For single pole MCB's				
16	1020	39 x 1	0.283	SZ-KS4/39N

For double pole MCB's

16	1044	24 x 2	0.650	SZ-PSB92N (3)
----	------	--------	-------	---------------

For triple pole MCB's

16	980	16 x 3	0.632	SZ-PSB52N (3)
----	-----	--------	-------	---------------

Insulated end caps

	Weight	Order Code
(3)	0.001	PSB-END3
(4)	0.001	PSB-END4
(6)	0.001	PSB-END6

Cover for unused busbar ways

	Weight	Order Code
5 ways	0.003	SZ-BSK
5 ways SZ-PSB12N only	0.003	SZ-BSK5



[Return to main index](#)

Protecta

Protecta Type B Pan Assemblies

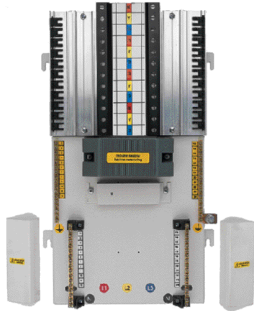

Technical Details

- Designed and manufactured to BSEN 60439-3
- Rated voltage 400V AC
- Busbar rating 250A
- Supplied with Earth and Shrouded Neutral Bars
- Cable capacity Earth and Neutral Bars 25mm²
- Finished in RAL7035

TP&N Pan Assemblies

No. of outgoing TP&Nways	Weight Kg	Order Code
4	3.5	EPB304PA
6	4.3	EPB306PA
8	5.1	EPB308PA
12	6.4	EPB312PA
16	8.2	EPB316PA
20	10.2	EPB320PA
24	12	EPB324PA

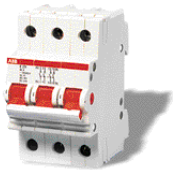

Incomers

Description	Rating	Sensitivity (mA)	Order Code
35mm ² terminal block (requires 3)			SZ-ESK
70mm ² cable block			EPBKIT4
120mm ² cable block			EPBKIT3
Switch disconnecter	100A 3 pole		E273/100rt
Switch disconnecter	125A 3 pole		E273/125rt
RCCB	63A 4 pole	30	F364-63/0.03
RCCB	63A 4 pole	100	F364-63/0.1
RCCB	63A 4 pole	300	F364-63/0.3
RCCB time delay	63A 4 pole	300	F394-63/0.3
Non Auto TPMCCB	250A 3 pole		1SDA051327R1
Front cable connection kit for above MCCB (requires 2)			1SDA051482R1



Incomer Connection Kits

Description	Order Code
RCCB connection kit	EPBKIT2
Non-auto 250A MCCB connection kit	EPBKIT1 - T3
Single phase kit	EPBKIT6



Description	Order Code
Unused way busbar cover (strip of 5)	SZ-BSK

Not suitable for the S500, S290 and S951 MCB's

For Protecta Final Distribution Boards please refer to:
ABB Installer Products Catalogue number 1TXD000001P0201



[Return to main index](#)

Notes

A large grid of red lines for taking notes, consisting of 20 columns and 40 rows of small squares.

[Return to main index](#)

S500 range

High Performance Miniature circuit breakers S500 B,C & D trip curves.
BS EN 60898. Ratings 6 to 63A.

Description

The ever increasing demand for energy is resulting in continually increasing short circuit currents in low voltage electrical networks. This places high demands on the protective switchgear with regard to safety, reliability and breaking capacity.

The High Performance MCB S500 satisfies these requirements by virtue of its special technical features. It is provided with a thermal and/or electromagnetic release to protect circuits, motors, equipment and systems from the results of overload and short circuit currents.

S 500

Standards		EN 60898, IEC 947-2, UL 1077, GE conformity, CAN/CSA-C22.2 N235-M89	
Poles			1P, 2P, 3P, 4P
Rated current I _n	[A]		6 to 63
Rated voltage U _e	[V]		690
Rated breaking capacity acc. to IEC 898	I _{cn} service I _{cs}	[kA] [kA]	25 12.5
Rated breaking capacity acc. to IEC 947-2 - 230/400V	ultimate I _{cu} service I _{cs}	[kA] [kA]	50 25
Rated breaking capacity acc. to IEC 947-2 - 440V	ultimate I _{cu} service I _{cs}	[kA] [kA]	30 22
Rated breaking capacity acc. to IEC 947-2 - 500V	ultimate I _{cu} service I _{cs}	[kA] [kA]	15 11
Rated breaking capacity acc. to IEC 947-2 - 690V	ultimate I _{cu} service I _{cs}	[kA] [kA]	6 3
Rated breaking capacity acc. to UL 1077 and CSA - 240V	I _{cc}	[kA]	30 (up to 25A); 18 (25 to 63 A)
Rated breaking capacity acc. to UL 1077 and CSA - 277/480V	I _{cc}	[kA]	14
Rated breaking capacity acc. to UL 1077 and CSA - 600V	I _{cc}	[kA]	6
Thermomagnetic release characteristics	B: 3 I _n I _m 5 I _n C: 5 I _n I _m 10 I _n D: 10 I _n I _m 20 I _n		• • •
Reference temperature	[°C]		30°C
Rated frequency			16 2/3 ... 60 Hz
Tropicalization			DIN 50016
Current limitation at I _{cc} 30 kA			I _p < 8000A
Total short-circuit breaking time			max. 2.5 ms at I _{cc} 30 kA
Mechanical life			20000
Protection degree			IP20
Ambient temperature (with daily average +35°C)	[°C]		-25...+55
Mounting			on DIN rail EN 50022 (35mm) by means of rapid fixing device
Line connection			top/bottom
Terminal size upper/lower per cable	[mm ²]		25/25

for further technical details please refer to S500 technical catalogue number 10139/A

[Return to main index](#)

S500 Range

High Performance Miniature circuit breakers S500 B,C & D trip curves.
BS EN 60898. Ratings 6 to 63A.



Type S500B (3-5 In) BS EN 60898.

Small inrush or switching surges,
heating loads, tungsten lighting.

Rated Current [A]	1-pole	2-pole	3-pole	4-pole
6	S501-B6	S502-B6	S503-B6	S504-B6
10	S501-B10	S502-B10	S503-B10	S504-B10
13	S501-B13	S502-B13	S503-B13	S504-B13
16	S501-B16	S502-B16	S503-B16	S504-B16
20	S501-B20	S502-B20	S503-B20	S504-B20
25	S501-B25	S502-B25	S503-B25	S504-B25
32	S501-B32	S502-B32	S503-B32	S504-B32
40	S501-B40	S502-B40	S503-B40	S504-B40
50	S501-B50	S502-B50	S503-B50	S504-B50
63	S501-B63	S502-B63	S503-B63	S504-B63



Type S500C (5-10 In) BS EN 60898.

Moderate switching surges for
short durations.

Rated Current [A]	1-pole	2-pole	3-pole	4-pole
6	S501-C6	S502-C6	S503-C6	S504-C6
10	S501-C10	S502-C10	S503-C10	S504-C10
13	S501-C13	S502-C13	S503-C13	S504-C13
16	S501-C16	S502-C16	S503-C16	S504-C16
20	S501-C20	S502-C20	S503-C20	S504-C20
25	S501-C25	S502-C25	S503-C25	S504-C25
32	S501-C32	S502-C32	S503-C32	S504-C32
40	S501-C40	S502-C40	S503-C40	S504-C40
50	S501-C50	S502-C50	S503-C50	S504-C50
63	S501-C63	S502-C63	S503-C63	S504-C63



Type S500D (10-14 In) BS EN 60898.

High inrush applications.

Rated Current [A]	1-pole	2-pole	3-pole	4-pole
10	S501-D10	S502-D10	S503-D10	S504-D10
13	S501-D13	S502-D13	S503-D13	S504-D13
16	S501-D16	S502-D16	S503-D16	S504-D16
20	S501-D20	S502-D20	S503-D20	S504-D20
25	S501-D25	S502-D25	S503-D25	S504-D25
32	S501-D32	S502-D32	S503-D32	S504-D32
40	S501-D40	S502-D40	S503-D40	S504-D40
50	S501-D50	S502-D50	S503-D50	S504-D50
63	S501-D63	S502-D63	S503-D63	S504-D63

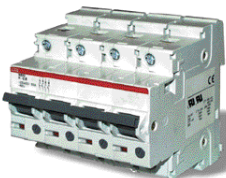

[Return to main index](#)

S500K Range

High Performance Miniature Circuit Breakers S500 K trip curve.

BS EN 60947. Ratings 0.15 to 45A.

Type S500K (8-14 In) BS EN 60947.

Protection of motors, transformers lamps and cable.

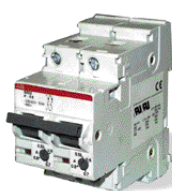

Adjustment Range (A)	1-pole	2-pole	3-pole
0.1 - 0.15	S501K0.15	S502K0.15	S503K0.15
0.14 - 0.21	S501K0.21	S502K0.21	S503K0.21
0.2 - 0.3	S501K0.3	S502K0.3	S503K0.3
0.28 - 0.42	S501K0.42	S502K0.42	S503K0.42
0.38 - 0.58	S501K0.58	S502K0.58	S503K0.58
0.53 - 0.8	S501K0.8	S502K0.8	S503K0.8
0.73 - 1.1	S501K1.1	S502K1.1	S503K1.1
1 - 1.5	S501K1.5	S502K1.5	S503K1.5
1.4 - 2.1	S501K2.1	S502K2.1	S503K2.1
2 - 3	S501K3	S502K3	S503K3
2.8 - 4.2	S501K4.2	S502K4.2	S503K4.2
3.8 - 5.8	S501K5.8	S502K5.8	S503K5.8
5.3 - 8	S501K8	S502K8	S503K8
7.3 - 11	S501K11	S502K11	S503K11
10 - 15	S501K15	S502K15	S503K15
14 - 20	S501K20	S502K20	S503K20
18 - 26	S501K26	S502K26	S503K26
23 - 32	S501K32	S502K32	S503K32
29 - 37	S501K37	S502K37	S503K37
34 - 41	S501K41	S502K41	S503K41
28 - 45	S501K45	S502K45	S503K45

Accessories

Description	Order Code
Auxiliary contact 1no/1nc	S500-H11
Auxiliary contact 2no	S500-H20
Signal contact 1no/1nc	S500-S11
Signal contact 2no	S500-S20
Padlock adaptor	S500-SA
Rotary drive 1 to 3 pole	S500-RD3
Rotary drive 4 to 6 pole	S500-RD4
Undervoltage release 24, 110, 230, 400V AC	UA *
Undervoltage release 24, 110, 230, 400VDC	UA *
Shunt trip 24, 110, 230, 400V AC/DC	AL *

*When ordering shunt or undervoltage trips please add suffix and voltage to the S500 reference number as these devices have to be factory fitted.

For starter co-ordination tables please request S500 catalogue 10107/B

[Return to main index](#)

System proM

Single pole & Switched Neutral Miniature circuit breakers S951N.

C trip curves. BS EN 60898. Ratings 2 to 40A.

Description

SPSN Miniature Circuit Breakers in a single module width. Ideal for applications where regulations require the neutral to be switched such as Petrol Stations and Caravan Sites etc.

Technical Details

- Current ratings 2 to 40 A at 30 degrees C to BS EN 60898
- Rated voltage 230V AC
- Maximum operating voltage 250VAC.
- Minimum operating voltage 12 VAC/DC
- Breaking capacity: BS EN 60898 - 6kA.
- Space saving
- All poles disconnected in event of a fault
- Mechanical service life: 20,000 operations.
- Cable capacity: 16mm² upper and lower terminals.
- Weight: 110g
- Ambient temperature: -25 to +55°C

Type S951NC (5-10 In) BS EN 60898.

Single pole & switched neutral
miniature circuit breakers



Current (A)	Weight (kg)	Order Code
2	0.110	S951NC2
4	0.110	S951NC4
6	0.110	S951NC6
10	0.110	S951NC10
16	0.110	S951NC16
20	0.110	S951NC20
25	0.110	S951NC25
32	0.110	S951NC32
40	0.110	S951NC40

[Return to main index](#)

System proM

Residual Current Devices

BSEN 61008 Ratings 16 to 100A.

Description

- ABB residual current devices have a measuring system consisting of a summation transformer with a permanent magnet tripping device, operating without the need of an auxiliary supply, to open a circuit automatically if an earth leakage fault occurs between phase and earth greater or equal to its rated sensitivity in mA.
- Provision of earth leakage, switching and isolation functionality to electrical circuits.
- Same form and design as the S2 MCB range, allowing easy interconnection with busbar blocks and common mounting in distribution panels.
- Suitable for symmetrical DIN rail or panel mounting.

Technical Data

- Specification to BSEN 61008: F360, F660 Class AC, F370 and F390 Class A
- Rated Voltage: Two pole 230V AC, Four pole 230/400V AC.
- Maximum operating voltage: Rated voltage + 10%.
- Test button range: 100V AC up to 264VAC
- Frequency: 50 to 60 Hz.
- Cable capacity: 25mm² up to 63A, 50mm² for 80 and 100A
- Life expectancy: at least 5,000 operations.
- Maximum tightening torque: 3Nm.
- Ambient temperature: -25°C to +55°C
- Maximum weights: 2pole 0.365kg, 4 pole 0.49kg.
- Dimensions: see page 3-46

Two Pole F362 & F662. Class AC.

Current (A)	Sensitivity			
	10mA	30mA	100mA	300mA
16	F362-16/0.01	-	-	-
25	-	F362-25/0.03	F362-25/0.1	F362-25/0.3
40	-	F362-40/0.03	F362-40/0.1	F362-40/0.3
63	-	F362-63/0.03	F362-63/0.1	F362-63/0.3
80	-	F662-80/0.03	F662-80/0.1	F662-80/0.3
100	-	F662-100/0.03	F662-100/0.1	F662-100/0.3



Four Pole F364 & F664. Class AC.

Current (A)	Sensitivity		
	30mA	100mA	300mA
25	F364-25/0.03	F364-25/0.1	F364-25/0.3
40	F364-40/0.03	F364-40/0.1	F364-40/0.3
63	F364-63/0.03	F364-63/0.1	F364-63/0.3
80	F664-80/0.03	F664-80/0.1	F664-80/0.3
100	F664-100/0.03	F664-100/0.1	F664-100/0.3



Two Pole F372 & F392. Class A (pulsating DC sensitive)

Current (A)	Sensitivity		
	30mA	100mA	300mA
25	F372-25/0.03	F372-25/0.1	F372-25/0.3
40	F372-40/0.03	F372-40/0.1	F372-40/0.3
63	F372-63/0.03	F372-63/0.1	F372-63/0.3
63 time delayed	-	-	F392-63/0.3



Four Pole F374 & F394. Class A (pulsating DC sensitive)

Current (A)	Sensitivity		
	30mA	100mA	300mA
25	F374-25/0.03	F374-25/0.1	F374-25/0.3
40	F374-40/0.03	F374-40/0.1	F374-40/0.3
63	F374-63/0.03	F374-63/0.1	F374-63/0.3
63 time delayed	-	F394-63/0.1	F394-63/0.3



[Return to main index](#)

System proM

Add on Residual Current Blocks DDA60 series

Ratings to 63A. BSEN 61009 when connected to MCB

Application

DDA60 blocks attach to the right hand side of any multipole S260, S270 or S280 MCB to form an RCBO in compliance to BS EN 61009. This standard defines that it shall be possible to assemble the RCBO on site only once, and that any subsequent disassembly shall leave permanent visible damage.

The assembly of the block provides a high level of earth fault protection in addition to the short circuit and overload protection provided by the MCB to which it is coupled.

The assembled RCBO is suitable for mounting on DINrail or into a wide range of DIN enclosures.

Technical Data

- Standard BS EN 61009 when coupled to an MCB. Class AC device.
- Rated voltage 230 - 400V AC.
- Maximum operating voltage 440V AC.
- Minimum operating voltage 195V AC.
- Frequency 50/60Hz
- Mechanical life: 20,000 operations.
- Cable capacity: 25mm² up to 63A
- Weight: two pole 0.21g, three pole 0.27g, four pole 0.33g.



DDA60 blocks. BS EN 61009.

Residual current blocks

Current (A)	Sensitivity		
	30mA	100mA	300mA
Two Pole 63A	DDA62-63/0.03	DDA62-63/0.1	DDA62-63/0.3
Three Pole 63A	DDA63-63/0.03	-	DDA63-63/0.3
Four Pole 63A	DDA64-63/0.03	-	DDA64-63/0.3

[Return to main index](#)

System proM

Single pole and Solid Neutral RCBO DS271 series

Ratings 6 to 32A. BS EN 61009-2-2. Class AC

Application

To provide protection against earth leakage faults, short circuits and overloads in residential, commercial and industrial electrical distribution systems.

Suitable for installation on DIN rail, Housemaster Consumer Units and Protecta Final Distribution Boards and Pan Assemblies.

Technical Data

- BS EN 61009-2-2 Class AC device.
- Current ratings 6 to 32A.
- Rated voltage 230V AC.
- Breaking capacity 10kA to BSEN 60898
- Maximum service voltage 253VAC.
- Minimum service voltage 195V AC.
- Service life at least 5,000 switching cycles.
- Lockable in On or Off position.
- Supplied with 800mm flying neutral and functional earth leads.
- Outgoing cable size 10mm²
- Weight 0.125g



DS271 blocks. BS EN 61009.

Single module width RCBO 17.5mm

Current (A)	Sensitivity	Type B (3-5 In)	Type C (5-10 In)
6	30mA	DS271AC-B6/0.03	DS271AC-C6/0.03
10	30mA	DS271AC-B10/0.03	DS271AC-C10/0.03
16	30mA	DS271AC-B16/0.03	DS271AC-C16/0.03
20	30mA	DS271AC-B20/0.03	DS271AC-C20/0.03
25	30mA	DS271AC-B25/0.03	DS271AC-C25/0.03
32	30mA	DS271AC-B32/0.03	DS271AC-C32/0.03

Devices of 10mA sensitivity available on request.

[Return to main index](#)

System proM

Single pole and switched neutral RCBO DS651 & DS671 series Ratings 6 to 40A. BS EN 61009

Application

To provide protection against earth leakage faults, short circuits and overloads in residential, commercial and industrial electrical distribution systems.

Ideal for applications where regulations require the neutral to be switched such as Petrol Stations and Caravan Sites etc.

Suitable for mounting on DIN rail, in ABB Protecta Distribution Boards or in a wide range of DIN enclosures

Technical Data

- BSEN 61009. Class AC devices
- Current ratings 6 to 40A.
- Rated voltage 230/400V AC
- Breaking capacity: DS651 - 6kA, DS671 - 10kA to BS EN 61009.
- Maximum service voltage 440V AC.
- Minimum operating voltage 110VAC.
- Frequency 50 / 60 Hz
- Life expectancy 10,000 electrical and 20,000 mechanical operations.
- Lockable in On or Off position.
- Weight 0.280g
- DS651 and DS671 RCBO are compatible with the S2 family accessories i.e. auxiliary contacts, shunt trips, signal contacts etc. see page 3/10

DS651 & DS671 RCBO. BS EN 61009.

Type C Curve (5-10 In)

Current (A)	Sensitivity	6 kA	10 kA
6	30mA	DS651C6/0.03	DS671C6/0.03
10	30mA	DS651C10/0.03	DS671C10/0.03
16	30mA	DS651C16/0.03	DS671C16/0.03
20	30mA	DS651C20/0.03	DS671C20/0.03
25	30mA	DS651C25/0.03	DS671C25/0.03
32	30mA	DS651C32/0.03	DS671C32/0.03
40	30mA	DS651C40/0.03	
16	10mA	DS651C16/0.01	



[Return to main index](#)

System proM

RD2 residual current monitors

Application

Residual current monitors (RCMS) with external transformer can detect leakage currents. Through minidips you can set sensitivity and time delay.

Technical Characteristics

Standard		IEC62020
Operating voltage	[V]	110 to 400a.c.; 48 to 110d.c.
Frequency	[Hz]	50 to 60
Sensitivity settings	[I n]	0.03; 0.1; 0.3; 0.5; 1; 2A
Time delay settings	[s]	0.05 (fast); 0.3; 0.5; 1; 2; 5
Contact capacity	[A]	10 at 250V a.c. (ohmic)
Contact type		change over
Operating temperature	[°C]	-5...+40
Power consumption	[W]	0.8 at 110V a.c.; 1.8 at 230V a.c.; 6.8 at 400V a.c. 0.2 at 48V d.c.; 1 at 110V d.c.
Number of modules	[No]	2

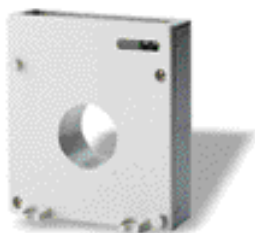

Description

Description	Order Code
Residual current monitor	RD2
Toroidal transformer Ø 35mm	TR35
Toroidal transformer Ø 60mm	TR60
Toroidal transformer Ø 80mm	TR80
Toroidal transformer Ø 110mm	TR110
Toroidal transformer Ø 210mm	TR210
Toroidal transformer Ø 210mm (opening version)	TR210/A
Modular toroidal transformer Ø 29mm	TRM

[Return to main index](#)

System proM

E 240 - E 270 switch disconnectors

Technical Details

Rated Voltage U	[V]	a.c. 230/400
Rated current I	[A]	63....125
Rated frequency	[Hz]	50/60
Rated short-time withstand current	[A]	20 times I _n x 1 second
Utilization category		AC22 (E240); AC23 (E270, 63....100A) AC22 (E270, 125A)
Modules	[No]	2, 3, 4
Standards		BS EN 60947-3
Approvals		E272-4 63A: VDE, SEV; E273 63A: VDE, SEV, DEMKO.

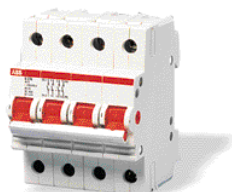
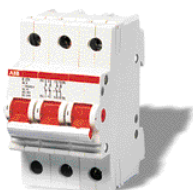
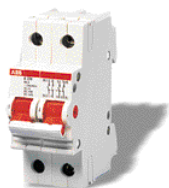

	Order Code
Double Pole switch disconnectors	
63A Rated current (2 module)	E242/63rt
100A rated current (2 module)	E272/100rt
125A rated current (2 module)	E272/125rt
Triple Pole switch disconnectors	
63A Rated current (3 module)	E243/63rt
100A rated current (3 module)	E273/100rt
125A rated current (3 module)	E273/125rt
Four Pole switch disconnectors	
63A Rated current (4 module)	E244/63rt
100A rated current (4 module)	E274/100rt
125A rated current (4 module)	E274/125rt

[Return to main index](#)

System proM

Installation Contactor ESB series

Ratings to 63A.

ESB series contactors

For loads to be automatically controlled through high number of operations; i.e. building automation, controlling of small pumps, ventilations, heating systems, lighting systems, and so on.

This series consists of various models differing in the number of contacts, rated current and control circuit voltage.

Technical Data	ESB 20	ESB24	ESB40	ESB63
Rated Voltage U_n	230VAC	400VAC	400V AC	400VAC
Rated current I_n in AC1	20A	24A	40A	63A
Rated power in AC3	230V	1.3kW	2.2kW	5.5kW
	400V	-	4kW	11kW
Rated frequency	50/60Hz	40/450Hz	40/450Hz	40/450Hz
Control circuit voltage (V)	a.c. 24, 110, 230	a.c./d.c. 24, 230	a.c./d.c. 24, 230	a.c./d.c. 24, 230
Electrical operations	1 million	1 million	1 million	1 million
Mechanical operations	in AC1	150,000	130,000	150,000
	in AC3	150,000	500,000	170,000
Power consumption	1W per pole	1.2W per pole	3W per pole	6W per pole
Modules	1	2	3	3
Standards	IEC60947-4-1	IEC 60947-4-1	IEC60947-4-1	IEC 60947-4-1
	IEC 61095	IEC 61095	IEC 61095	IEC 61095



ESB 20 (20A) Contactors.

	Order Code
Control circuit voltage 24V a.c. - 1NO + 1NC contacts	ESB20-11/24
Control circuit voltage 110V a.c. - 1NO + 1NC contacts	ESB20-11/110
Control circuit voltage 230V a.c. - 1NO + 1NC contacts	ESB20-11/230

Control circuit voltage 110V a.c. - 2NC contacts	ESB 20-02/110
Control circuit voltage 230V a.c. - 2NC contacts	ESB 20-02/230

Control circuit voltage 24V a.c. - 2NO contacts	ESB 20-20/24
Control circuit voltage 110V a.c. - 2NO contacts	ESB 20-20/110
Control circuit voltage 230V a.c. - 2NO contacts	ESB 20-20/230

ESB 24 (24A) Contactors.

	Order Code
Control circuit voltage 24V a.c./d.c. - 4NO contacts	ESB24-40/24
Control circuit voltage 230V a.c./d.c. - 4NO contacts	ESB24-40/230

ESB 40 (40A) Contactors.

	Order Code
Control circuit voltage 24V a.c./d.c. - 4NO contacts	ESB40-40/24
Control circuit voltage 230V a.c./d.c. - 4NO contacts	ESB40-40/230

ESB 63 (63A) Contactors.

	Order Code
Control circuit voltage 24V a.c./d.c. - 4NO contacts	ESB63-40/24
Control circuit voltage 230V a.c./d.c. - 4NO contacts	ESB63-40/230

Auxiliary Elements / Accessories

Available for ESB 24/40/63

	Order Code
2NO contacts	EH04-20
1NO + 1NC contacts	EH04-11
Spacer	ESB-DIS
Terminal Covers for ESB 24	ESB-PLK 24
Terminal Covers for ESB 40/63	ESB-PLK 40/63

[Return to main index](#)

System proM

Latching relays E250 series

Ratings to 16A.

Application

Electro-magnetic latching relays allow contact switching for each impulse sent to coil using normally open pushbuttons. Ideal for lamp controlling from different positions, they are available in various versions according to pick-up voltage and to contact positions. They also allow manual operation on the product and contact position indicator (visual on the product).

Technical Data

Rated Voltage U_n	[V]	a.c. 400 / 250
Rated Current I_n	[A]	10 / 16
Rated Frequency	[Hz]	50 / 60
Contact Capacity	[W]	2300 (incandescent lamps) 1300 (power factor uncorrected fluorescent lamps $\cos \phi=0.6$) 500 (power factor corrected fluorescent lamps in parallel)
Minimum value of control impulse	[mA]	50
Circuit voltage	[V]	8, 12, 24, 230
Electric operations	[No]	100,000
Mechanic operations	[No]	1 million
Power consumption	[W]	2 (1 and 2 contacts);
Modules	[No]	1
Standards		IEC/EN 60669-2
Approvals		DEMKO, NEMKO, SEMKO, SEV, FI

E250 latching relays.

With 1 and 2 contacts

Description	Order Code
relay with 1 contact - 8V a.c.	E251-8V
relay with 1 contact - 12V a.c.	E251-12V
relay with 1 contact - 24V a.c.	E251-24V
relay with 1 contact - 230V a.c.	E251-230V
relay with 2 contacts - 8V a.c.	E252-8V
relay with 2 contacts - 12V a.c.	E252-12V
relay with 2 contacts - 24V a.c.	E252-24V
relay with 2 contacts - 230V a.c.	E252-230V
relay with 1NC + 1NO contact - 8V a.c.	E256-8V
relay with 1NC + 1NO contact - 12V a.c.	E256-12V
relay with 1NC + 1NO contact - 24V a.c.	E256-24V
relay with 1NC + 1NO contact - 230V a.c.	E256-230V
relay with 2 sequential contact - 8V a.c.	E255-8V
relay with 2 sequential contact - 12V a.c.	E255-12V
relay with 2 sequential contact - 24V a.c.	E255-24V
relay with 2 sequential contact - 230V a.c.	E255-230V



[Return to main index](#)

System proM

Pushbuttons and indicator lamps E220 series

Ratings to 16A.

Application

The pushbuttons are used for remote control in every kind of electrical installation (public, tertiary, industrial).

The indicator lamps signal any event in every kind of electric installation (public, tertiary, industrial).

Technical Data

Rated voltage U_n	[V]	a.c. 250
Rated current I_n	[A]	16
Rated frequency	[Hz]	50 / 60
Power consumption	[W]	0.96 ... 1.50
Modules	[No]	1
Standards		IEC/EN 60669-1 IEC/EN 60947-5-1



E225 pushbuttons.

Description	Order Code
Grey pushbutton with contacts 1NO + 1NC	E225-11B
Red pushbutton with contacts 1NO + 1NC	E225-11C
Green pushbutton with contacts 1NO + 1NC	E225-11D
Yellow pushbutton with contacts 1NO + 1NC	E225-11E
Black pushbutton with contacts 1NO + 1NC	E225-11F
Blue pushbutton with contacts 1NO + 1NC	E225-11G

E227 Illuminated pushbuttons.

Description	Order Code
Transparent illuminated pushbutton with contacts 1NO + 1NC	E227-11B
Red illuminated pushbutton with contacts 1NO + 1NC	E227-11C
Green illuminated pushbutton with contacts 1NO + 1NC	E227-11D
Yellow illuminated pushbutton with contacts 1NO + 1NC	E227-11E
Blue illuminated pushbutton with contacts 1NO + 1NC	E227-11G

E229 Indicator lamps.

Description	Order Code
Transparent indicator lamp with 220V a.c. bulb	E229-B
Red indicator lamp with 220V a.c. bulb	E229-C
Green indicator lamp with 220V a.c. bulb	E229-D
Yellow indicator lamp with 220V a.c. bulb	E229-E
Blue indicator lamp with 220V a.c. bulb	E229-G

[Return to main index](#)

System proM

Time switches ETS & DTS series

Application

To control circuit opening and closing according to scheduled planning. The time switches can be set on permanent ON-OFF, available both daily and weekly programmes. Suitable for mounting on DINrail, in ABB Housemaster Consumer unit or DINenclosures.

ETS Time switches.

Electro-Mechanical

Description	Order Code
daily programme without standby battery - 3 modules	ETS-1
daily programme with standby battery (200h) - 3 modules	ETS-1/R
weekly programme with standby battery (200h) - 3 modules	ETS-7/R

Technical Data

Rated Voltage U_n	[V]	a.c. 230 +/- 10%
Rated contact capacity I_n	[A]	16 cos ϕ =1 4 cos ϕ =0.6
Rated frequency	[Hz]	50 / 60
Min. spread between two commands		15 min (daily programme) 2 hours (weekly programme)
Max. number of command per cycle	[No]	96 (daily programme) 84 (weekly programme)
Operating accuracy		1s / 24h
Life cycle	[No]	10 years or 50,000 insertions
Operating temperature	[°C]	-10...+45
Power consumption	[W]	0.5
Modules	[No]	1-3
Standards		IEC 60669-1, EN 60730-1



Application

The range includes single/multichannel daily/weekly programme switches. These are functionally more sophisticated and control several loads or independent groups of loads requiring different time controls with an unique time reference. The EEPROM memory of DTS series devices eliminates the risk of erasing configured programme, regardless the duration of any voltage failure.

DTS Time switches.

Digital time switches

Description	Order Code
daily programme time switch with standby battery (3years), 1 channel	DTS 1/1
daily/weekly programme time switch with standby battery (3years), 1 channel	DTS 7/1
daily/weekly programme time switch with standby battery (3years), 2 channels	DTS 7/2
daily/weekly programme time switch with standby battery (3years), 2 channels + pulse output	DTS 7/2 I
daily/weekly programme time switch with standby battery (150h), 3 channels	DTS 7/3

Technical Data

Rated Voltage U_n	[V]	a.c. 230
Rated contact capacity I_n	[A]	16 cos ϕ =1 2.5 cos ϕ =0.6
Rated frequency	[Hz]	50 / 60
Operating accuracy		\pm 2.5s / 24h
Max. Switching	[Fr ²]	12 (daily programme - 1 channel) 28 (weekly programme - 1 channel) 42 (weekly programme - 2 channels) 322 (daily/weekly programme - 3 channels)
Power consumption	[W]	5
Modules	[No]	2, 6 (3 channels)
Standards		IEC/EN 60730-1



[Return to main index](#)

System proM

Power failure signalling lamps LE

Application

The built-in battery allows the charging of the lamp when the device is connected to network voltage. It automatically switches on when the voltage fails allowing an easy and safe operation within the consumer unit or the switchboard it is installed in. A green led signals the standard operation and a red led indicates the device OFF for battery saving.

Technical Characteristics

Rated voltage Un	[V]	a.c. 230
Rated Frequency	[Hz]	50/60
Power consumption	[W]	10
Number of modules	[No]	2
Max. recharge cycles	[No]	500
Indications		Green led = standard operation Red led = lamp OFF
Standby battery	[min]	45
Lighting level	[lumen]	20



LE Power failure signalling lamp.

Description

Power failure signalling lamp

Order Code

LE-230

[Return to main index](#)

System proM

Bell transformers TM series

Application

These transformers are for feeding bells (discontinuous use) and have very low secondary safety voltage.

Technical Characteristics

Standards		EN 61558-1/2-8
Primary Rated voltage Un	[V]	a.c. 230
Secondary Rated voltage Un	[V]	4, 8, 12, 24
Rated Frequency	[Hz]	50
Power consumption	[VA]	8, 10, 15, 16, 24, 30, 40 (discontinuous service)
Power consumption	[W]	1...4
Number of modules	[No]	2, 3

TM Bell transformers.



Description	Order Code
sec. 4-8-12V (10VA discontinuous)	TM10/12
sec. 12-24V (10VA discontinuous)	TM10/24
sec. 4-8-12V (15VA discontinuous)	TM15/12
sec. 12-24V (15VA discontinuous)	TM15/24
sec. 4-8-12V (30VA discontinuous)	TM30/12
sec. 12-24V (30VA discontinuous)	TM30/24
sec. 4-8-12V (40VA discontinuous)	TM40/12
sec. 12-24V (40VA discontinuous)	TM40/24

[Return to main index](#)

System proM

Twilight switches TWS-1 series

Application

To switch-on and/or switch-off operating illuminating devices at preset level of ambient lighting. Used in combination with sensor detecting if lighting level is higher or lower than preset threshold.

Technical Characteristics

Standards		IEC 60669-1, EN 61000-3-2
Rated voltage Un	[V]	a.c. 230
Rated contact capacity In	[A]	16 (ohmic)
		25 (inductive load cos=0.6)
	[W]	1000 (power factor corrected fluorescent lamps)
Rated Frequency	[Hz]	50/60
Adjustment range	[Lux]	2...300
Hysteresis	[%]	1.3 (of present value)
Delay	[s]	
Switch-on		+50
Switch-off		+50
Max. distance between twilight switch and sensor	[m]	100
Twilight switch operating time	[°C]	-20...+55
Sensor operating time	[°C]	-30...+70
Power consumption	[W]	5
Number of modules	[No]	2



TWS Twilight switches.

Description	Order Code
Twilight switch with sensor	TWS-1
Sensor (as spare part)	LS-1

[Return to main index](#)

The Idea

5 state-of-the-art protection devices of identical design are simply plugged onto a busbar system.

No need for an elaborate power supply and connection work.

In addition to the saving in time and costs, a further advantage of the system is that it permits fast and easy replacement of the devices.

If corresponding spare capacity is planned, subsequent expansion is achieved by simply plugging the additional devices onto the busbar

Combination Module

Using a combination module, you can configure a variety of devices. For instance a motor protection circuit-breaker together with a contactor can be arranged to form one single unit.

Various Power Supply Options

You can supply power, for example, via a residual current circuit-breaker. The busbars can be interrupted by means of isolators so that residual current devices can be configured in groups.

The Trick with the Click

Devices are simply plugged onto the system without the need for any auxiliary adapters. Correction and expansion work couldn't be easier.



Freedom in Concept and Arrangement

Smisline gives you freedom of choice: Mixed-pole arrangements are accommodated with ease.



Vertical Equipment Layout

With a vertical layout you can save even more space as this arrangement renders outgoing terminals unnecessary. The outgoing cables are connected directly to the devices.



Shock-hazard Protection

All busbars can be covered with shock-hazard protection covers. This makes the entire system touch-proof.



Signalling

Signal and auxiliary contacts are available for all devices. They can be powered directly by the use of two auxiliary busbars within the socket base.

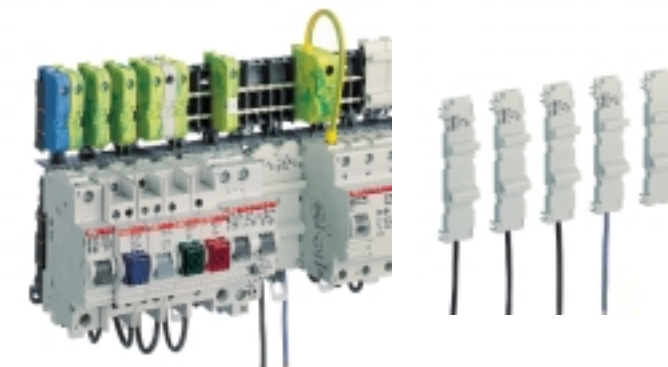

DIN Rail Products

Thanks to the DIN rail adapter, a variety of devices can be integrated into the system.

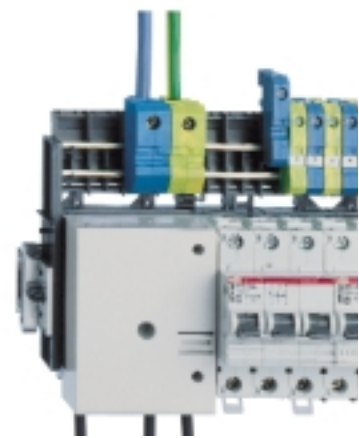

Compact Design

Smisline saves space while providing effective shock-hazard protection. With the outer N-terminal acting as the isolator, a single-pole outgoing circuit L/N/PE up to 32A requires an overall width of just 18mm.

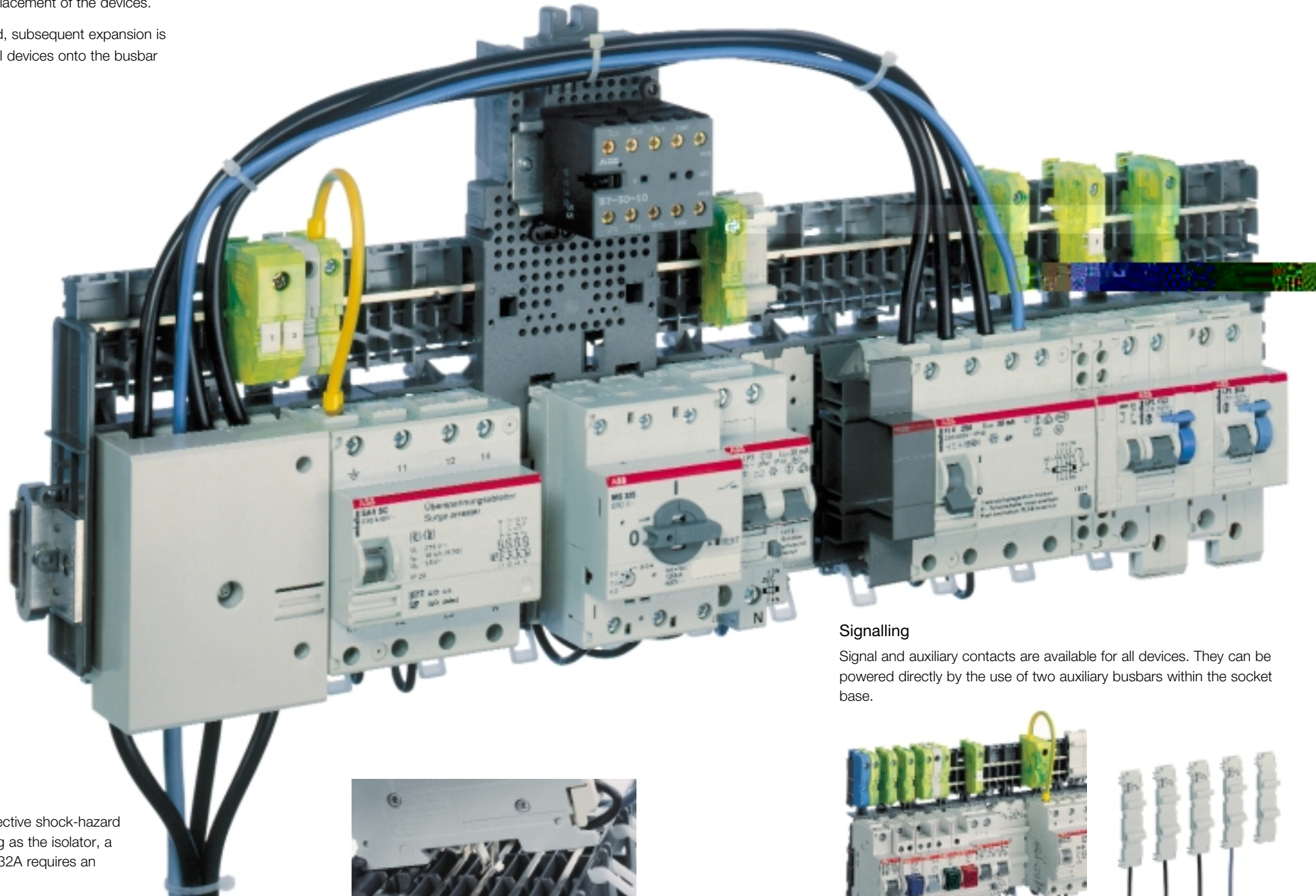

Flexible, Fast, Ideal

Any changes in configuration are carried out quickly, and additional devices are simply plugged on for expansion.



Return to main index

Smisline

Fields of Application: Advantages and Benefits



ABB Smisline flexible distribution system

The ABB Smisline system is a unique concept allowing maximum flexibility in a "plug-in" final distribution system. The assembly consists of a base and busbar system onto which can be "plugged" MCB's, RCD's, RCBO's and Isolators with a complete range of add-on accessories.

For full technical details please request the Smisline catalogue 20165/C, or ask for an ABB sales engineer to demonstrate the Smisline benefits to you.

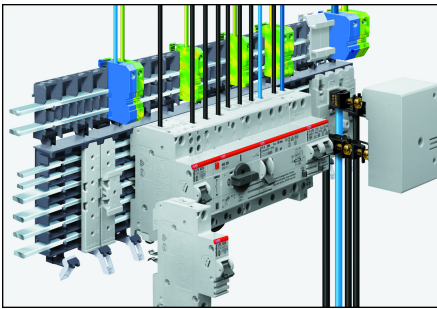

Industrial Buildings

- High Degree of system availability
- Combination module as complete motor starter unit
- Clear allocation of devices and terminals

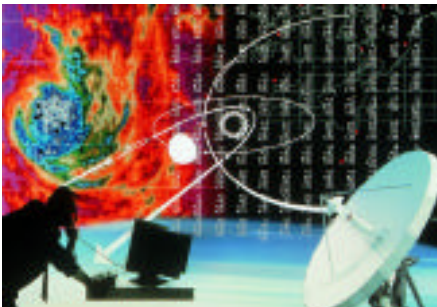

Telecommunications

- Interchangeability of devices
- Overvoltage-protected systems
- Specifically targeted device and circuit protection



Shopping Centres

- Quick change configuration
- Clearly arranged RC protection structure
- Mixed-pole devices can be placed in any position



EDP and Radio Installations

- Central installation monitoring
- Flexible adaptation to building requirements
- Permanent current availability

[Return to main index](#)

Smisline

Fields of Application: Advantages and Benefits



Airports

- High Degree of system availability
- Short realization time
- Cost-effective adaptation



Hospitals, Clinics

- High Degree of safety and reliability for maintenance/service
- Residual current signalling device for monitoring
- Permanent current availability



Banks, Insurance Companies

- Various power supply options
- Clearly arranged RC protection structure
- System modifications can be carried out quickly

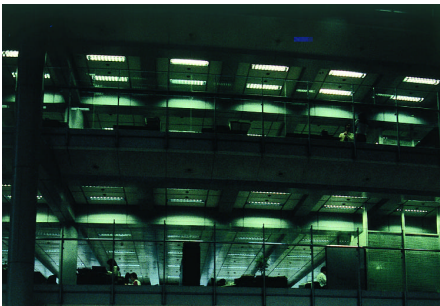

Office Buildings

- Flexibility in lighting and air conditioning systems
- Expansion options
- Flexibility for system modifications



Traffic

- Short time delayed residual current circuit-breakers for long cables
- Overvoltage-protection system
- Fast replacement of combination module as complete motor starter unit



[Return to main index](#)

Surge Protection

Optical Monitoring Block

Surge Protection

Surge Protection

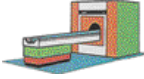
	Electrotechnical equipment	Electrical equipment containing little sensitive electronics	Sensitive electronic equipment	Highly sensitive electronic equipment
Type of equipment to be protected				
Protection Level up	from 1.8 to 2.5kV	from 1.5 to 1.8kV	from 1 to 1.5kV	from 0.5 to 1 kV

Determine Exposure Level

The Exposure level is defined by the number of lightning strikes per km² (Ng) in the concerned area or by the keraunic level (Nk) of this zone (how many times thunder is heard in one year).

Ng and/or Nk are data that regional meteorological offices can give you.

The mean Nk value for Europe is 25.

Empirically, one can estimate the $Ng = 0.10 \times Nk$, i.e. a mean Ng value of 2.50 for Europe.

Refer to the following tables for product selection

Characteristics

For use on 230/400V networks	single phase
Max. number of 17.7mm modules monitored/Type of arresters	15 / PU - PM
Emitter current consumption at 230V in watch state	< 10mA
Receiver current consumption at 230V in watch state	< 10mA
Teleindication contact data	SPDT
- min. voltage / min. current	6V DC / 10mA
- max. voltage (50Hz) / max. current (50Hz)	250V / 5A
Optical link visualization	LED on emitter and receiver
Fault Visualisation (one of the arresters reserved or disconnected)	red indication on receiver
Terminal wire capacity	2.5mm ² solid
Recommended circuit-breaking device	2A fuse
Operating temperature	-20°C to +40°C
Storage temperature	-40°C to +70°C

Selection

Body Colour	Type	Order Code
● Grey	OVR S1GN	2CTB813815R0000

BOS 230



[Return to main index](#)

Surge Protection

Single-pole lightning arresters 15kA

Slightly Exposed Area:
Imax 15kA
Ng 0.5

Equipment Type	Up	Value of the equipment to be protected (in US \$)		
		2,000	20,000	
Electrotechnical	2.5 kV	optional		
Electronic little sensitive	1.8 kV			
Electronic sensitive	1.0 kV		recommended	
Electronic highly sensitive	0.5 kV			

Characteristics

For use on IT or TN-C networks	230V / 400V
Max discharge current (once) 8/20 wave form	15kA
Max. continuous operating voltage Uc	250V / 440V
Nominal discharge current (20 times) 8/20 wave	5kA
Protection level Up	1.2kV / 1.8kV
Internal short circuit withstand current Icc	10kA
Continuous operating current	< 1mA
Follow current	none
Built-in thermal disconnection	yes
Reserve system	none
Visualization of arrester status	yes
Terminal wire gauge (stranded/solid)	Ph/N: 16/25mm ² - Ground 35/50mm ²
Operating temperature	-20°C to +40°C
Storage temperature	-40°C to +70°C

Surge Protection Single-pole lightning arresters 15kA

Selection

Body Colour	Information	Type	Order Code
<input type="radio"/> White	Single-pole lightning arresters non pluggable	OVR 15-440	2CTB813811R0400
<input type="radio"/> White	Single-pole lightning arresters	OVR 15-440P	2CTB813851R1200
<input type="radio"/> White	Single-pole lightning arresters remote control	OVR 15-440PTS	2CTB813851R0600
<input type="radio"/> White	Replacement cartridges	OVR 15-440C	2CTB813854R0600

Surge Protection Double-pole lightning arresters 15kA

Selection

Body Colour	Information	Type	Order Code
<input type="radio"/> White	Double-pole lightning arresters non pluggable	OVRNI 15-275	2CTB813812R0400
<input type="radio"/> White	Double-pole lightning arresters	OVRNI 15-275P	2CTB813852R1200
<input type="radio"/> White	Double-pole lightning arresters remote control	OVRNI 15-275PTS	2CTB813852R0600
<input type="radio"/> White	Replacement cartridges	OVRNI 15-275C	2CTB813854R1200
<input type="radio"/> White	Neutral cartridges	OVRNI 15-275NC	2CTB813854R0000

[Return to main index](#)

Surge Protection

15kA Lightning Arresters

Surge Protection Four-pole lightning arresters 15kA



Selection

Body Colour	Information	Type	Order Code
<input type="radio"/> White	Four-pole lightning arresters non pluggable	OVRN3-15-275	2CTB813813R0400
<input type="radio"/> White	Four-pole lightning arresters pluggable	OVRN3-15-275P	2CTB813853R1200
<input type="radio"/> White	Four-pole lightning arresters remote control	OVRN3-15-275PTS	2CTB813853R0600
<input type="radio"/> White	Replacement cartridges	OVR 15-275C	2CTB813854R1200
<input type="radio"/> White	Neutral cartridges	OVR 65NC	2CTB813854R0000

[Return to main index](#)

Surge Protection

40kA Protection Information

Exposed Area:
I_{max} 40kA
0.5 < Ng 1

Equipment Type	Up	Value of the equipment to be protected (in US \$)		
		2,000	20,000	
Electrotechnical	2.5 kV	optional		
Electronic little sensitive	1.8 kV		recommended	
Electronic sensitive	1.0 kV			
Electronic highly sensitive	0.5 kV			highly

Exposed to very exposed Area:
I_{max} 40kA
1 < Ng 1.3
I_{max} 65kA
1.3 < Ng 1.5

Equipment Type	Up	Value of the equipment to be protected (in US \$)		
		2,000	20,000	
Electrotechnical	2.5 kV		recommended	
Electronic little sensitive	1.8 kV			
Electronic sensitive	1.0 kV			highly
Electronic highly sensitive	0.5 kV			

Characteristics

For use on IT or TN-C networks	230V / 400V
Max discharge current (once) 8/20 wave form	40kA
Max. continuous operating voltage U _c	250V / 440V
Nominal discharge current (20 times) 8/20 wave	15kA
Protection level Up	1.2kV (multipole)
Internal short circuit withstand current I _{cc}	25kA
Continuous operating current	< 1mA
Follow current	none
Built-in thermal disconnection	yes
Reserve system	none
Visualization of arrester status	yes
Terminal wire gauge (stranded/solid)	16/25mm ²
Operating temperature	-20°C to +40°C
Storage temperature	-40°C to +70°C

[Return to main index](#)

Surge Protection

40kA Lightning Arresters

Surge Protection Single-pole lightning arresters 40kA



Selection

Body Colour	Information	Type	Order Code
<input type="radio"/> White	Single-pole lightning arresters non pluggable	OVR 40-440	2CTB813811R0300
<input type="radio"/> White	Single-pole lightning arresters pluggable	OVR 40-440P	2CTB813851R1100
<input type="radio"/> White	Single-pole lightning arresters remote control	OVR 40-440PTS	2CTB813851R0500
<input type="radio"/> White	Replacement cartridges	OVR 40-440C	2CTB813854R0400

Surge Protection Double-pole lightning arresters 40kA



Selection

Body Colour	Information	Type	Order Code
<input type="radio"/> White	Double-pole lightning arresters non pluggable	OVRNI-40-275	2CTB813812R0300
<input type="radio"/> White	Double-pole lightning arresters pluggable	OVRNI-40-275P	2CTB813852R1100
<input type="radio"/> White	Double-pole lightning arresters remote control	OVRNI-40-275PTS	2CTB813852R0500
<input type="radio"/> White	Replacement cartridges	OVR40-275C	2CTB813854R1000
<input type="radio"/> White	Neutral cartridges	OVR 65NC	2CTB813854R0000

Surge Protection Four-pole lightning arresters 40kA



Selection

Body Colour	Information	Type	Order Code
<input type="radio"/> White	Four-pole lightning arresters non pluggable	OVRN3-40-275	2CTB813813R0300
<input type="radio"/> White	Four-pole lightning arresters pluggable	OVRN3-40-275P	2CTB813853R1100
<input type="radio"/> White	Four-pole lightning arresters remote control	OVRN3-40-275PTS	2CTB813853R0500
<input type="radio"/> White	Replacement cartridges	OVR40-275C	2CTB813854R1000
<input type="radio"/> White	Neutral cartridges	OVR 65NC	2CTB813854R0000

[Return to main index](#)

Surge Protection

65kA Protection Information

**Highly Exposed Area:
I_{max} 65kA
1.5 < Ng 2**

Equipment Type	Up	Value of the equipment to be protected (in US \$)		
		2,000	20,000	
Electrotechnical	2.5 kV		recommended	
Electronic little sensitive	1.8 kV			
Electronic sensitive	1.0 kV		highly	
Electronic highly sensitive	0.5 kV			

**Highly Exposed Area:
Maximum Risk
I_{max} 65kA
2 < Ng 2.5**

Equipment Type	Up	Value of the equipment to be protected (in US \$)		
		2,000	20,000	
Electrotechnical	2.5 kV	recommended		
Electronic little sensitive	1.8 kV			
Electronic sensitive	1.0 kV		highly	
Electronic highly sensitive	0.5 kV			

Characteristics

For use on IT or TN-C networks	230V / 400V
Max discharge current (once) 8/20 wave form	65kA
Max. continuous operating voltage U _c	250V / 440V
Nominal discharge current (20 times) 8/20 wave	20kA
Protection level Up	1.5kV; 2kV
Internal short circuit withstand current I _{cc}	25kA
Continuous operating current	< 1mA
Follow current	none
Built-in thermal disconnection	yes
Reserve system	yes
Visualization of arrester status	yes
Terminal wire gauge (stranded/solid)	Ph/N:16/25mm ² - Ground 35/50mm ²
Operating temperature	-20°C to +40°C
Storage temperature	-40°C to +70°C

[Return to main index](#)

Surge Protection

65kA Lightning Arresters

Surge Protection Single-pole lightning arresters 65kA



Selection

Body Colour	Information	Type	Order Code
<input type="radio"/> White	Single-pole lightning arresters non pluggable	OVR 65-440S	2CTB813811R0100
<input type="radio"/> White	Single-pole lightning arresters	OVR 65-440SP	2CTB813851R0700
<input type="radio"/> White	Single-pole lightning arresters remote control	OVR 65-440SPTS	2CTB813851R0100
<input type="radio"/> White	Replacement cartridges	OVR 65-440SC	2CTB813854R0100

Surge Protection Double-pole lightning arresters 65kA



Selection

Body Colour	Information	Type	Order Code
<input type="radio"/> White	Double-pole lightning arresters non pluggable	OVRNI-65-440S	2CTB813812R0100
<input type="radio"/> White	Double-pole lightning arresters	OVRNI-65-275SP	2CTB813852R0700
<input type="radio"/> White	Double-pole lightning arresters remote control	OVRNI-65-275SPTS	2CTB813852R0100
<input type="radio"/> White	Replacement cartridges	OVR-65-275SC	2CTB813854R0700
<input type="radio"/> White	Neutral cartridges	OVR-65NC	2CTB813854R0000

Surge Protection Four-pole lightning arresters 65kA



Selection

Body Colour	Information	Type	Order Code
<input type="radio"/> White	Four-pole lightning arresters non pluggable	OVRN3-65-440S	2CTB813813R0100
<input type="radio"/> White	Four-pole lightning arresters	OVRN3-65-275SP	2CTB813853R0700
<input type="radio"/> White	Four-pole lightning arresters remote control	OVRN3-65-275-SPTS	2CTB813853R0100
<input type="radio"/> White	Replacement cartridges	OVR-65-275SC	2CTB813854R0700
<input type="radio"/> White	Neutral cartridges	OVR-65NC	2CTB813854R0000

[Return to main index](#)

Notes

A large grid of red lines for taking notes, consisting of 20 columns and 30 rows of small squares.

[Return to main index](#)

Technical Details

Tripping Curves

Tripping characteristic	B	C	D
Standard	IEC/EN 60898	IEC/EN 60898	IEC/EN 60898
Rated current I_n	6...100A	0.5...100A	0.5...63A

Thermal trip

Test currents:

non-tripping current I_{nf}	1.13 I_n	1.13 I_n	1.13 I_n
non-tripping time	>1h	>1h (up to 63A)	> 2h (> 63A)
tripping current I_f	1.45 I_n	1.45 I_n	1.45 I_n
tripping time	< 1h	< 1h (up to 63A)	< 2h (> 63A)

Electro-magnetic trip

Test currents:

non-tripping current I_{m1}	3 I_n	5 I_n	10 I_n
non-tripping time	> 0.1s	> 0.1s	> 0.15s
tripping current I_{m2}	5 I_n	10 I_n	20 I_n
tripping time	< 0.1s	< 0.1s	< 0.15s

Characteristic B

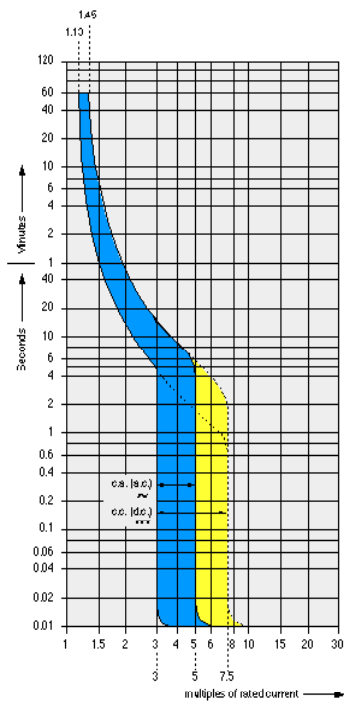

Characteristic C

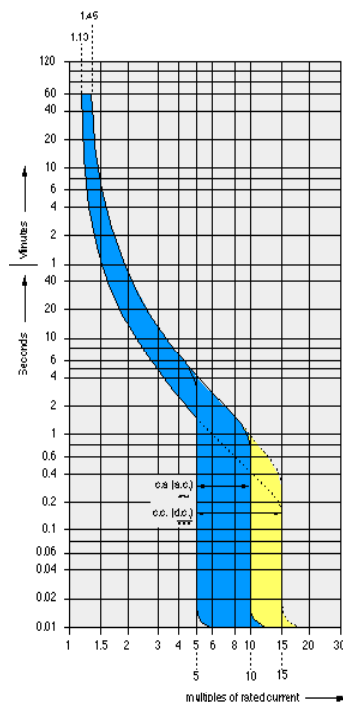

Characteristic D

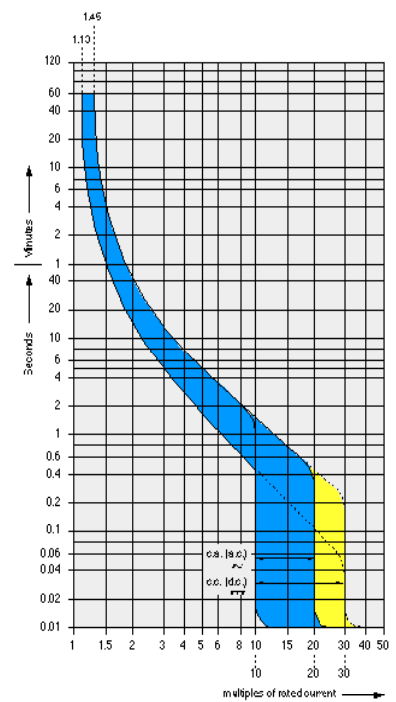

[Return to main index](#)

Technical Details

Tripping Curves

Characteristics K-Z selective

Tripping characteristics according to DIN VDE 0660. Rated currents from 0.5 to 63A, in 16 different values.

They are used to control and protect inductive circuits, power suppliers for semi-conductor electronic circuits and secondary measurement circuits, in the commercial and industrial sectors.

Tripping characteristic	K	Z
Standard	IEC/EN60947	IEC/EN60947
Rated current I_n	0.5...63A	0.5...63A

Thermal trip

Test currents:

non-tripping current I_{nf}	$1.05I_n$	$1.05I_n$
non-tripping time	>2h	>2h
tripping current I_f	$1.2I_n$	$1.2I_n$
tripping time	< 2h	< 2h

Electro-magnetic trip

non-tripping current I_{m1}	$8I_n$	$2I_n$
non-tripping time	> 0.2s	> 0.2s
tripping current I_{m2}	$14I_n$	$3I_n$
tripping time	< 0.2s	< 0.2s

Characteristic K

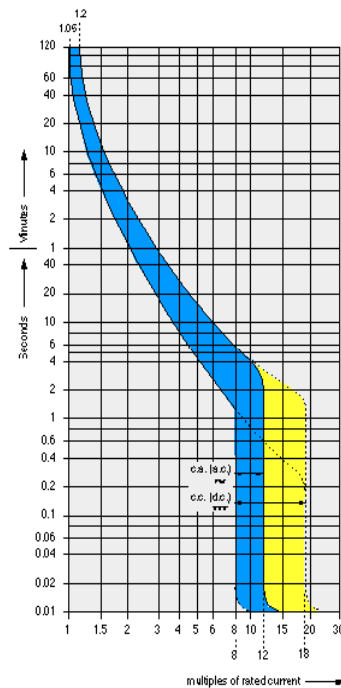

Characteristic Z

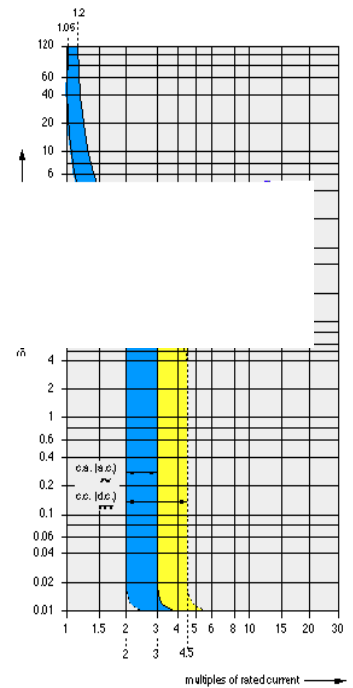

[Return to main index](#)

Dimensions

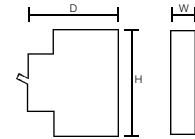

Type	Extra Info	H	W	D
S270 - S280	1P	85	17.5	74
	2P	85	35	74
	3P	85	52.5	74
	4P	85	70	74
S2-H..		85	8.75	68
S2-S - S2S/H		85	8.75	68
S2-BM		85	17.5	68
S500	1P	91	25	92
	2P	91	50	92
	3P	91	75	92
	4P	91	100	92
S951		83	17.8	68
F360	2P	90	35	68
	4P	90	70	68
DDA60	2P	94	35	68
	3P	94	70	68
	4P	94	70	68
DS651 - DS671		97	35	74
RD2		85	35	64.8
E240 - E270	2P	90	35	68
	3P	90	52.5	68
	4P	90	70	68
ESB Contactors	ESB20	85	17.5	58
	ESB24	85	35	58
	ESB40	85	54	58
	ESB63	85	54	58
E250	1P	85	17.5	58
	2P	85	35	58
E220	1P	85	17.5	68
ETS	1P	85	17.5	58
	3P	88.5	52.4	58
DTS	2P	85	35	58
	6P	82	105	53
LE		85	35	58
TM	TM10 - 12	85	35	58
	TM30 - 40	85	52.5	58
TWS		82	35	60
OVR	1P	87	17.5	69
	2P	87	35	69
	4P	87	70	69

[Return to main index](#)