

D-SERIES DRM DRMKITP115VAC 2CO LD/PB

Weidmüller Interface GmbH & Co. KG
 Klingenbergstraße 26
 D-32758 Detmold
 Germany
 Fon: +49 5231 14-0
 Fax: +49 5231 14-292083
 www.weidmueller.com

Product image



Similar to illustration

Our relay kits are particularly convenient to use. The kits are delivered fully assembled and 100 % function-tested. This saves assembly time and reduces the number of parts required.

- Assembled kit consisting of relay, base and retaining clip, incl. label
- 100% function-tested
- 100% control of the dielectric strength input - output
- Optional: test button with coloured control voltage marking (AC coil: red / DC coil: blue) and mechanical switch position indicator
- Bright status LED (AC coil: red / DC coil: green)

General ordering data

Type	DRMKITP115VAC 2CO LD/PB
Order No.	2576000000
Version	D-SERIES DRM, Relay module, Number of contacts: 2, CO contact with test button AgNi 0,15 µm Au, Rated control voltage: 115 V AC, Continuous current: 10 A, PUSH IN
GTIN (EAN)	4050118585759
Qty.	10 pc(s).
Relevant base	7760056362
Relevant relay	7760056075

Creation date 24 August 2020 10:38:19 CEST

D-SERIES DRM
DRMKITP115VAC 2CO LD/PB

Weidmüller Interface GmbH & Co. KG
 Klingenbergstraße 26
 D-32758 Detmold
 Germany
 Fon: +49 5231 14-0
 Fax: +49 5231 14-292083
 www.weidmueller.com

Technical data**Dimensions and weights**

Width	30.6 mm	Width (inches)	1.205 inch
Height	101.8 mm	Height (inches)	4.008 inch
Depth	82.3 mm	Depth (inches)	3.24 inch
Net weight	97.552 g		

Temperatures

Humidity	35...85 % rel. humidity, no condensation	Operating temperature, max.	55 °C
Operating temperature, min.	-40 °C	Storage temperature, max.	70 °C
Storage temperature, min.	-40 °C	Operating temperature	-40 °C...55 °C
Storage temperature	-40 °C...70 °C		

Environmental Product Compliance

REACH SVHC Lead 7439-92-1

Input

Rated control voltage	115 V AC	Rated current AC	12.6 mA (50 Hz), 10.8 mA (60 Hz)
Power rating	1.0...1.2VA (60HZ)	Pull-in/drop-out voltage, typ.	92 V / 34.5 V AC
Coil resistance	400 Ω ± 10 %	Status indicator	red LED

Output

Rated switching voltage	250 V AC	Max. switching voltage, AC	250 V
Continuous current	10 A	AC switching capacity (resistive), max.	2500 VA
DC switching capacity (resistive), max.	240 W @ 24 V	Switch-on delay	< 20 ms
Switch-off delay	< 20 ms	Min. switching power	10 mA @ 12 V, 100 mA @ 5 V
Max. switching frequency at rated load	0.1 Hz		

Contact data

Contact type	2 CO contact with test button (AgNi 0,15 µm Au)	Contact resistance	≤ 50 mΩ
Mechanical service life	20 x 10 ⁶ switching cycles		

General data

Rail	TS 35	Test button	yes (lockable)
Mechanical switch position indicator	Yes	Colour	black

Insulation coordination

Rated voltage	250 V	Surge voltage category	III
Pollution severity	2	Insulating material group	C
Protection degree	IP20	Dielectric strength, Input/Output	1.8 kV _{eff} / 1 min.
Creepage and clearance distance input - output	≥ 5.5 mm	Dielectric strength of neighbouring contacts	1 kV _{eff} / 1 min
Dielectric strength of open contact	1 kV _{eff} / 1 min		

D-SERIES DRM
DRMKITP115VAC 2CO LD/PB

Weidmüller Interface GmbH & Co. KG
 Klingenbergstraße 26
 D-32758 Detmold
 Germany
 Fon: +49 5231 14-0
 Fax: +49 5231 14-292083
 www.weidmueller.com

Technical data**Further details of approvals / standards**

Certificate no. (cURus) relay	E312083	Certificate no. (cURus) base	E355547
-------------------------------	---------	------------------------------	---------

Connection data

Wire connection method	PUSH IN	Stripping length, rated connection	10 mm
Clamping range, rated connection	1.5 mm ²	Clamping range, min.	0.14 mm ²
Clamping range, max.	1.5 mm ²	Wire connection cross section AWG, min.	AWG 26
Wire connection cross section AWG, max.	AWG 16	Wire cross-section, solid, min.	0.14 mm ²
Wire cross-section, solid, max.	1.5 mm ²	Wire connection cross-section, finely stranded, min.	0.14 mm ²
Wire connection cross section, finely stranded, max.	1.5 mm ²	Wire connection cross-section, finely stranded with wire-end ferrules DIN 46228/4, min.	0.14 mm ²
Wire connection cross-section, finely stranded with wire-end ferrules DIN 46228/4, max.	1 mm ²	Conductor cross-section, flexible, AEH (DIN 46228-1), min.	0.14 mm ²
Conductor cross-section, flexible, AEH (DIN 46228-1), max.	1.5 mm ²	Blade size	0.4 x 2.5 mm

Classifications

ETIM 6.0	EC001437	ETIM 7.0	EC001437
eClass 9.0	27-37-16-01	eClass 9.1	27-37-16-01
eClass 10.0	27-37-16-01		

Approvals

Approvals



ROHS Conform

Downloads

Approval/Certificate/Document of Conformity	EU Konformitätserklärung / EU Declaration of Conformity
Engineering Data	EPLAN
Engineering Data	STEP

D-SERIES DRM
DRMKITP115VAC 2CO LD/PB

Weidmüller Interface GmbH & Co. KG
Klingenbergstraße 26
D-32758 Detmold
Germany
Fon: +49 5231 14-0
Fax: +49 5231 14-292083
www.weidmueller.com

Drawings

Wiring diagram

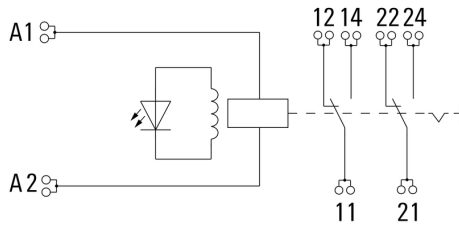

Graph

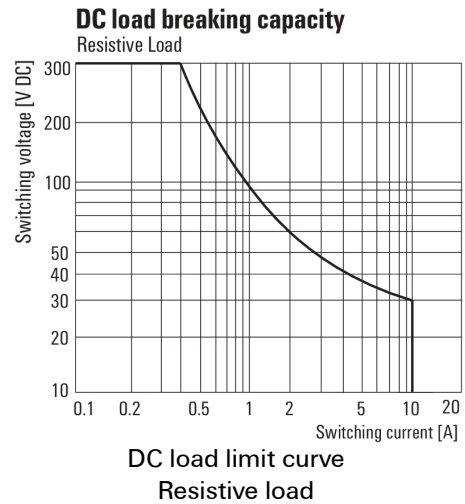

Graph



Graph

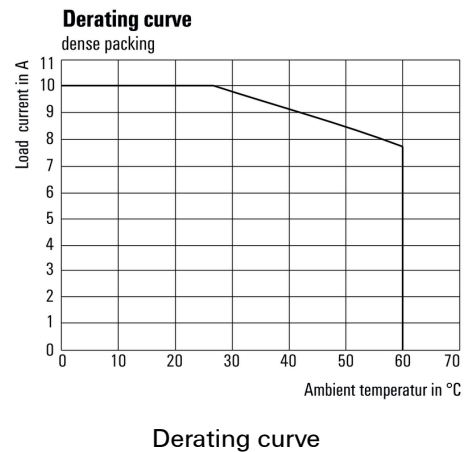

Graph

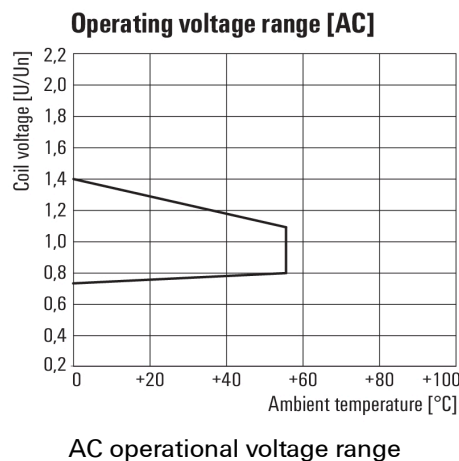

Dimensional drawing

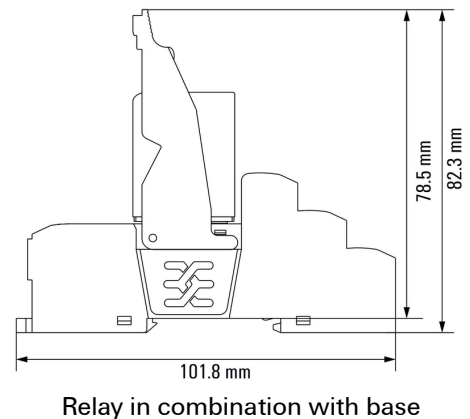

**D-SERIES DRM
DRMKITP115VAC 2CO LD/PB**

Weidmüller Interface GmbH & Co. KG
Klingenbergstraße 26
D-32758 Detmold
Germany
Fon: +49 5231 14-0
Fax: +49 5231 14-292083
www.weidmueller.com

Accessories

Cross-connection for base with PUSH IN connection

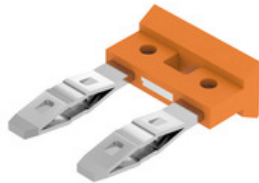

In an industrial environment, service work needs to be carried out quickly, simply and reliably. If components are replaced, bended relay contacts often cause errors which are difficult to locate.

As the handling of components in practice plays an increasingly important role, DRI relays have particularly stable plug contacts for quick and safe mounting. The test button with latching in end position can be operated tool-free. An easily visible, LED illuminated status display also allows clear determination of status.

Both during installation of the cabinet and during subsequent servicing in the machinery and plant engineering sector, DRI relays are the optimum coupling element for confined installation conditions.

General ordering data

Type	SCM/SDI P CC	Version
Order No.	7760056366	D-SERIES, Cross-connector
GTIN (EAN)	6944169773327	
Qty.	10 pc(s).	

Slotted screwdriver

Slotted screwdriver with rounded blade SD DIN 5265, ISO 2380/2, output to DIN 5264, ISO 2380/1. ChromTop tip, SoftFinish grip



General ordering data

Type	SDS 0.4X2.5X75	Version
Order No.	9009030000	Screwdriver, Blade width (B): 2.5 mm, Blade length: 75 mm, Blade thickness (A): 0.4 mm
GTIN (EAN)	4032248266944	
Qty.	1 pc(s).	

D-SERIES DRM
DRMKITP115VAC 2CO LD/PB

Weidmüller Interface GmbH & Co. KG
Klingenbergstraße 26
D-32758 Detmold
Germany
Fon: +49 5231 14-0
Fax: +49 5231 14-292083
www.weidmueller.com

Accessories

Protection modules



Accessories for D-SERIES relays include:

- Relay bases
- LED / Protective modules
- Metal retaining clips

General ordering data

Type	RIM 3 110/230VAC LED	Version
Order No.	7760056045	D-SERIES, RC filter, Rated control voltage: 110...230 V AC, Plug-in connection
GTIN (EAN)	4032248878147	
Qty.	10 pc(s).	

Type	RIM 3 110/230VAC	Version
Order No.	7760056014	D-SERIES, RC filter, Rated control voltage: 110...230 V AC, Plug-in connection
GTIN (EAN)	4032248878109	
Qty.	10 pc(s).	

LED



Accessories for D-SERIES relays include:

- Relay bases
- LED / Protective modules
- Metal retaining clips

General ordering data

Type	RIM 3 110/230VUC	Version
Order No.	7940018455	D-SERIES, LED module, Rated control voltage: 110...230 V UC, Plug-in connection
GTIN (EAN)	4032248878185	
Qty.	20 pc(s).	

D-SERIES DRM DRMKITP115VAC 2CO LD/PB

Weidmüller Interface GmbH & Co. KG
 Klingenbergstraße 26
 D-32758 Detmold
 Germany
 Fon: +49 5231 14-0
 Fax: +49 5231 14-292083
 www.weidmueller.com

Accessories

Retaining clip



Accessories for D-SERIES relays include:

- Relay bases
- LED / Protective modules
- Metal retaining clips

General ordering data

Type	DRM/DRL CLIP M	Version
Order No.	7760056108	D-SERIES, Retaining clip
GTIN (EAN)	4032248855568	
Qty.	10 pc(s).	

MultiCard



The Weidmüller device markers enable users to conform to obligatory equipment labelling regulations. Users can label the device markers themselves by means of suitable software and system-compatible printer systems. ESG is the tried-and-tested marker in MultiCard format. The result is high-quality device marking with a high-contrast appearance.

ESG 9/26 SCM ECO MC... for marking D-SERIES DRM relay sockets:

- Attachable MultiCard markers
- Depending on the relay socket it is attachable on up to 4 levels
- Additional option for attaching the marker on plastic retaining clip: SCM CLIP P
- PrintJet printable

General ordering data

Type	ESG 9/26 SCM ECO MC SDR	Version
Order No.	1525800000	ESG, Device markers x 26 mm, PA 66, Colour: To customer specification
GTIN (EAN)	4050118331875	
Qty.	80 pc(s).	
Type	ESG 9/26 SCM ECO MC NE ...	Version
Order No.	1521000000	ESG, Device markers x 26 mm, PA 66, Colour: grey
GTIN (EAN)	4050118327878	
Qty.	80 pc(s).	
Type	ESG 9/26 SCM ECO MC NE ...	Version
Order No.	1520980000	ESG, Device markers x 26 mm, PA 66, Colour: white
GTIN (EAN)	4050118327939	
Qty.	80 pc(s).	

Data sheet

**D-SERIES DRM
DRMKITP115VAC 2CO LD/PB**

Weidmüller Interface GmbH & Co. KG
Klingenbergstraße 26
D-32758 Detmold
Germany
Fon: +49 5231 14-0
Fax: +49 5231 14-292083
www.weidmueller.com

Accessories

Type	ESG 9/26 SCM ECO MC NE ...	Version
Order No.	1520990000	ESG, Device markers x 26 mm, PA 66, Colour: yellow
GTIN (EAN)	4050118327861	
Qty.	80 pc(s).	

ESG 6/15



Guaranteed long service life: ESG

The multi-colour and multi-format labels have a strong adhesive layer to ensure the best possible adhesion to the underlying surface. Double laminated polyester makes the basic material very thin and yet extremely tear-resistant.

Your benefits with MultiMark

- Double laminated polyester
- Can be used with equipment from many manufacturers
- Device markers with a familiar design

General ordering data

Type	ESG 6/15 MM WS	Version
Order No.	2619940000	ESG, Device markers, 6 x 15 mm, white
GTIN (EAN)	4050118626148	
Qty.	3,000 pc(s).	

Slotted screwdriver

VDE insulated slot-head screwdriver, SDI DIN 7437, ISO 2380/2, drive output acc. to DIN 5264, ISO 2380/1. SoftFinish grip



General ordering data

Type	SDIS 0.4X2.5X75	Version
Order No.	9008370000	Screwdriver, Blade width (B): 2.5 mm, Blade length: 75 mm, Blade thickness (A): 0.4 mm
GTIN (EAN)	4032248056330	
Qty.	1 pc(s).	

**D-SERIES DRM
DRMKITP115VAC 2CO LD/PB**

Weidmüller Interface GmbH & Co. KG
Klingenbergstraße 26
D-32758 Detmold
Germany
Fon: +49 5231 14-0
Fax: +49 5231 14-292083
www.weidmueller.com

Accessories**ESG 6/17****Guaranteed long service life: ESG**

The multi-colour and multi-format labels have a strong adhesive layer to ensure the best possible adhesion to the underlying surface. Double laminated polyester makes the basic material very thin and yet extremely tear-resistant.

Your benefits with MultiMark

- Double laminated polyester
- Can be used with equipment from many manufacturers
- Device markers with a familiar design

General ordering data

Type	ESG 6/17 MM WS	Version
Order No.	2005100000	ESG, Device markers, 6 x 17 mm, white
GTIN (EAN)	4050118390728	
Qty.	3.000 pc(s).	

Data sheet

**D-SERIES DRM
DRMKITP115VAC 2CO LD/PB**

Weidmüller Interface GmbH & Co. KG
 Klingenbergstraße 26
 D-32758 Detmold
 Germany
 Fon: +49 5231 14-0
 Fax: +49 5231 14-292083
 www.weidmueller.com

Drawings

Miscellaneous

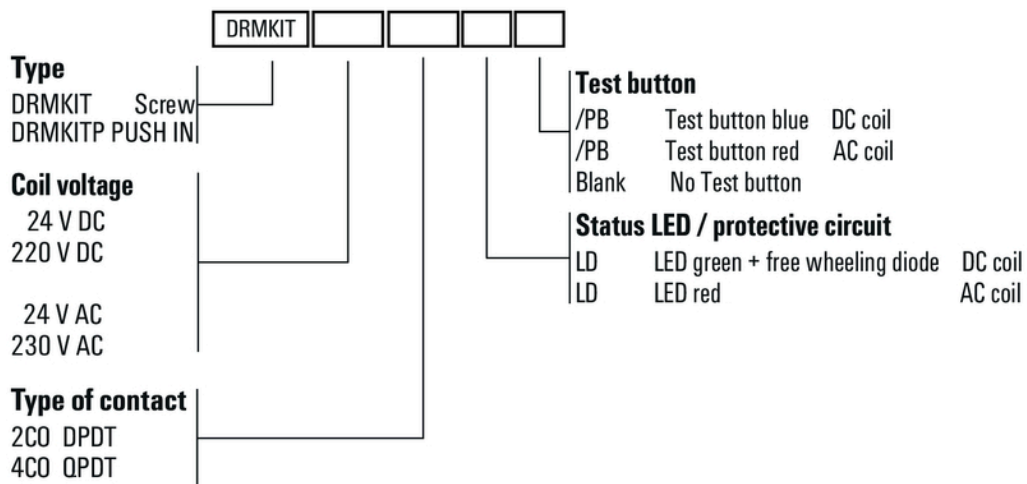

Type codes