

D-SERIES DRM DRMKIT 220VDC 4CO LD/PB

Weidmüller Interface GmbH & Co. KG
 Klingenbergstraße 26
 D-32758 Detmold
 Germany
 Fon: +49 5231 14-0
 Fax: +49 5231 14-292083
 www.weidmueller.com

Product image



Similar to illustration

Our relay kits are particularly convenient to use. The kits are delivered fully assembled and 100 % function-tested. This saves assembly time and reduces the number of parts required.

- Assembled kit consisting of relay, base and retaining clip, incl. label
- 100% function-tested
- 100% control of the dielectric strength input - output
- Optional: test button with coloured control voltage marking (AC coil: red / DC coil: blue) and mechanical switch position indicator
- Bright status LED (AC coil: red / DC coil: green)

General ordering data

Type	DRMKIT 220VDC 4CO LD/PB
Order No.	1542520000
Version	D-SERIES DRM, Relay module, Number of contacts: 4, CO contact with test button AgNi 0,15 µm Au, Rated control voltage: 220 V DC, Continuous current: 5 A, Screw connection
GTIN (EAN)	4050118347319
Qty.	10 pc(s).
Relevant base	7760056264
Relevant relay	7760056100

Creation date 24 August 2020 10:51:40 CEST

D-SERIES DRM
DRMKIT 220VDC 4CO LD/PB

Weidmüller Interface GmbH & Co. KG
 Klingenbergstraße 26
 D-32758 Detmold
 Germany
 Fon: +49 5231 14-0
 Fax: +49 5231 14-292083
 www.weidmueller.com

Technical data
Dimensions and weights

Width	27.2 mm	Width (inches)	1.071 inch
Height	79.9 mm	Height (inches)	3.146 inch
Depth	66.8 mm	Depth (inches)	2.63 inch
Net weight	93.35 g		

Temperatures

Operating temperature, max.	60 °C	Operating temperature, min.	-40 °C
Storage temperature, max.	70 °C	Storage temperature, min.	-40 °C
Operating temperature	-40 °C...60 °C	Storage temperature	-40 °C...70 °C

Environmental Product Compliance

REACH SVHC	Lead 7439-92-1
------------	----------------

Input

Rated control voltage	220 V DC	Rated current DC	5.2 mA
Power rating	1.2 W	Pull-in/drop-out voltage, typ.	154 V / 22 V DC
Coil resistance	42000 Ω ± 10 %	Status indicator	Green LED
Protective circuit	Free-wheeling diode		

Output

Rated switching voltage	250 V AC	Max. switching voltage, AC	250 V
Continuous current	5 A	Inrush current	10 A / 50 ms
AC switching capacity (resistive), max.	1250 VA	DC switching capacity (resistive), max.	120 W @ 24 V
Switch-on delay	< 20 ms	Switch-off delay	< 20 ms
Min. switching power	10 mA @ 12 V, 100 mA @ 5 V	Max. switching frequency at rated load	0.1 Hz

Contact data

Contact type	4 CO contact with test button (AgNi 0,15 µm Au)	Contact resistance	≤ 50 mΩ
Mechanical service life	20 x 10 ⁶ switching cycles		

General data

Rail	TS 35	Test button	yes (lockable)
Mechanical switch position indicator	Yes	Colour	black

Insulation coordination

Rated voltage	250 V	Surge voltage category	III
Pollution severity	2	Insulating material group	C
Protection degree	IP20	Dielectric strength, Input/Output	1.8 kV _{eff} / 1 min.
Creepage and clearance distance input – output	≥ 5.5 mm	Dielectric strength of neighbouring contacts	1 kV _{eff} / 1 min
Dielectric strength of open contact	1 kV _{eff} / 1 min	Impulse withstand voltage	4.8 kV (1.2/50 µs)

Further details of approvals / standards

Certificate no. (cURus) relay	E312083	Certificate no. (cURus) base	E312083
-------------------------------	---------	------------------------------	---------

Creation date 24 August 2020 10:51:40 CEST

Catalogue status 14.08.2020 / We reserve the right to make technical changes.

D-SERIES DRM
DRMKIT 220VDC 4CO LD/PB

Weidmüller Interface GmbH & Co. KG
 Klingenbergstraße 26
 D-32758 Detmold
 Germany
 Fon: +49 5231 14-0
 Fax: +49 5231 14-292083
 www.weidmueller.com

Technical data**Connection data**

Wire connection method	Screw connection	Stripping length, rated connection	7 mm
Tightening torque, min.	0.5 Nm	Tightening torque, max.	0.7 Nm
Clamping range, min.	0.5 mm ²	Clamping range, max.	2.5 mm ²
Wire cross-section, solid, min.	0.5 mm ²	Wire cross-section, solid, max.	2.5 mm ²
Wire connection cross-section, finely stranded, min.	0.5 mm ²	Wire connection cross section, finely stranded, max.	2.5 mm ²
Wire connection cross-section, finely stranded with wire-end ferrules DIN 46228/4, min.	0.5 mm ²	Wire connection cross-section, finely stranded with wire-end ferrules DIN 46228/4, max.	2.5 mm ²
Conductor cross-section, flexible, AEH (DIN 46228-1), min.	0.5 mm ²	Conductor cross-section, flexible, AEH (DIN 46228-1), max.	2.5 mm ²
Wire connection cross section, finely stranded, two clampable wires, min.	0.5 mm ²	Wire cross-section, finely stranded, two clampable wires, max.	1 mm ²
Blade size	size PH1		

Classifications

ETIM 6.0	EC001437	ETIM 7.0	EC001437
eClass 9.0	27-37-16-01	eClass 9.1	27-37-16-01
eClass 10.0	27-37-16-01		

Approvals

Approvals



ROHS

Conform

Downloads

Approval/Certificate/Document of Conformity	EU Konformitätserklärung / EU Declaration of Conformity
Engineering Data	EPLAN, WSCAD, Zuken E3.S
Engineering Data	STEP

**D-SERIES DRM
DRMKIT 220VDC 4CO LD/PB**

Weidmüller Interface GmbH & Co. KG
 Klingenbergstraße 26
 D-32758 Detmold
 Germany
 Fon: +49 5231 14-0
 Fax: +49 5231 14-292083
 www.weidmueller.com

Drawings

Wiring diagram

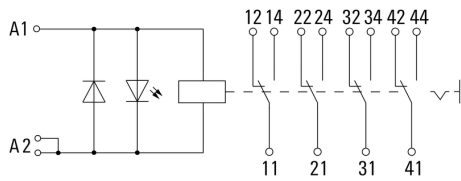

Graph

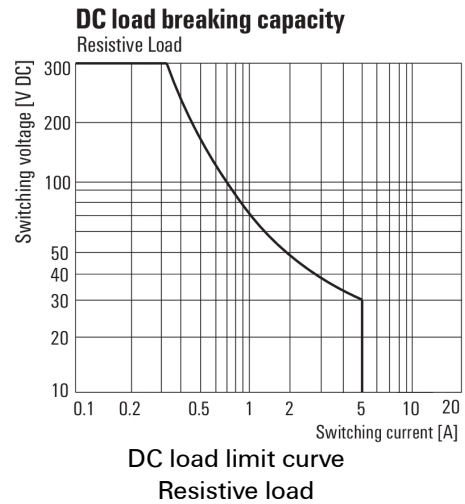

Graph

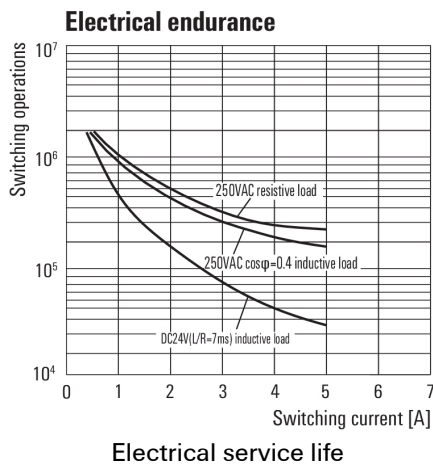

Graph

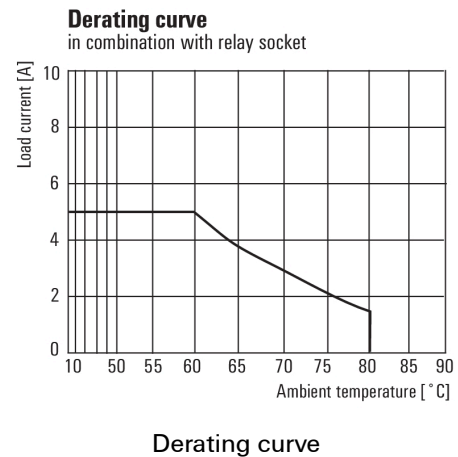

Graph

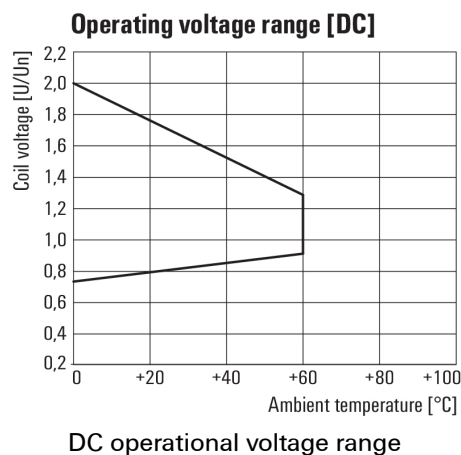

Dimensional drawing

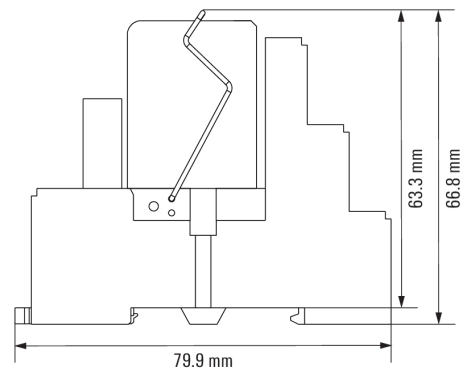

**D-SERIES DRM
DRMKIT 220VDC 4CO LD/PB**

Weidmüller Interface GmbH & Co. KG
 Klingenbergstraße 26
 D-32758 Detmold
 Germany
 Fon: +49 5231 14-0
 Fax: +49 5231 14-292083
 www.weidmueller.com

Accessories

Crosshead screwdriver, Phillips



VDE insulated screwdriver sets, for working on live parts up to 1000 V AC and 1500 V DC, DIN EN 60900. IEC 900. Each piece is "GS" safety tested. Blade made from fully hardened, high-alloy chromium-vanadium-molybdenum steel, gun-metal finish.

General ordering data

Type	SDIK PH1 SL	Version
Order No.	1274710000	Mounting tool, Blade length: 80 mm
GTIN (EAN)	4050118073249	
Qty.	1 pc(s).	

Crosshead screwdriver Phillips



VDE insulated crosshead screwdriver, for Phillips screws, SDIK PH DIN 7438, ISO 8764/2-PH, output to ISO 8764-PH, SoftFinish grip

General ordering data

Type	SDIK PH1	Version
Order No.	9008570000	Screwdriver, Blade length: 80 mm
GTIN (EAN)	4032248056569	
Qty.	1 pc(s).	

**D-SERIES DRM
DRMKIT 220VDC 4CO LD/PB**

Weidmüller Interface GmbH & Co. KG
Klingenbergstraße 26
D-32758 Detmold
Germany
Fon: +49 5231 14-0
Fax: +49 5231 14-292083
www.weidmueller.com

Accessories

Protection modules



Accessories for D-SERIES relays include:

- Relay bases
- LED / Protective modules
- Metal retaining clips

General ordering data

Type	RIM 1 6/230VDC	Version
Order No.	7760056169	D-SERIES, Free-wheeling diode, Rated control voltage: 6...230 V, Plug-
GTIN (EAN)	4032248967728	in connection
Qty.	10 pc(s).	

LED



Accessories for D-SERIES relays include:

- Relay bases
- LED / Protective modules
- Metal retaining clips

General ordering data

Type	RIM 3 110/230VUC	Version
Order No.	7940018455	D-SERIES, LED module, Rated control voltage: 110...230 V UC, Plug-in
GTIN (EAN)	4032248878185	connection
Qty.	20 pc(s).	

**D-SERIES DRM
DRMKIT 220VDC 4CO LD/PB**

Weidmüller Interface GmbH & Co. KG
 Klingenbergstraße 26
 D-32758 Detmold
 Germany
 Fon: +49 5231 14-0
 Fax: +49 5231 14-292083
 www.weidmueller.com

Accessories**LED / free-wheel diode**

Accessories for D-SERIES relays include:

- Relay bases
- LED / Protective modules
- Metal retaining clips

General ordering data

Type	RIM 2 110/230VDC	Version
Order No.	7760056017	D-SERIES, LED module with freewheel diode, Rated control voltage:
GTIN (EAN)	4032248896615	110...230 V DC, Plug-in connection
Qty.	10 pc(s).	

Cross-connection for base with screw connection

You place stringent demands on your relay combinations in industrial environments. Our D-SERIES relay modules were designed specifically for challenging industrial applications. Let's connect.

In many industrial applications voltages between 110 and 220 V are used to control actuators. With load currents exceeding 100 mA these high voltages produce arcing that causes a great deal of wear on the relay contacts.

We have designed our D-SERIES relay modules specifically for universal usage in a wide range of industrial applications. They are much more reliable than conventional solutions, which minimises costs for maintenance and replacement.

Thanks to series connected contacts, built-in blow magnets and low-wear contacts, arcing is effectively suppressed with D-SERIES products – resulting in a noticeably longer service life.

General ordering data

Type	SCM-I QV S	Version
Order No.	1132080000	RIDERSERIES RCM, Cross-connector
GTIN (EAN)	4032248912193	
Qty.	10 pc(s).	

Data sheet

**D-SERIES DRM
DRMKIT 220VDC 4CO LD/PB**

Weidmüller Interface GmbH & Co. KG
Klingenbergstraße 26
D-32758 Detmold
Germany
Fon: +49 5231 14-0
Fax: +49 5231 14-292083
www.weidmueller.com

Accessories

Crosshead screwdriver Phillips

Crosshead screwdriver, Phillips, SDK PH DIN 5262, ISO 8764/2-PH, output to ISO 8764-PH, ChromTop tip, SoftFinish grip



General ordering data

Type	SDK PH1	Version
Order No.	9008480000	Screwdriver, Blade width (B): 4.5 mm, Blade length: 80 mm
GTIN (EAN)	4032248056477	
Qty.	1 pc(s).	

Retaining clip

Accessories for D-SERIES relays include:

- Relay bases
- LED / Protective modules
- Metal retaining clips



General ordering data

Type	SCM CLIP P	Version
Order No.	7760056367	D-SERIES DRM, Retaining clip
GTIN (EAN)	6944169773334	
Qty.	5 pc(s).	

D-SERIES DRM DRMKIT 220VDC 4CO LD/PB

Weidmüller Interface GmbH & Co. KG
 Klingenbergstraße 26
 D-32758 Detmold
 Germany
 Fon: +49 5231 14-0
 Fax: +49 5231 14-292083
 www.weidmueller.com

Accessories

MultiCard



The Weidmüller device markers enable users to conform to obligatory equipment labelling regulations. Users can label the device markers themselves by means of suitable software and system-compatible printer systems. ESG is the tried-and-tested marker in MultiCard format. The result is high-quality device marking with a high-contrast appearance.

ESG 9/26 SCM ECO MC... for marking D-SERIES DRM relay sockets:

- Attachable MultiCard markers
- Depending on the relay socket it is attachable on up to 4 levels
- Additional option for attaching the marker on plastic retaining clip: SCM CLIP P
- PrintJet printable

General ordering data

Type	ESG 9/26 SCM ECO MC SDR	Version
Order No.	1525800000	ESG, Device markers x 26 mm, PA 66, Colour: To customer specification
GTIN (EAN)	4050118331875	
Qty.	80 pc(s).	
Type	ESG 9/26 SCM ECO MC NE ...	Version
Order No.	1521000000	ESG, Device markers x 26 mm, PA 66, Colour: grey
GTIN (EAN)	4050118327878	
Qty.	80 pc(s).	
Type	ESG 9/26 SCM ECO MC NE ...	Version
Order No.	1520980000	ESG, Device markers x 26 mm, PA 66, Colour: white
GTIN (EAN)	4050118327939	
Qty.	80 pc(s).	
Type	ESG 9/26 SCM ECO MC NE ...	Version
Order No.	1520990000	ESG, Device markers x 26 mm, PA 66, Colour: yellow
GTIN (EAN)	4050118327861	
Qty.	80 pc(s).	

**D-SERIES DRM
DRMKIT 220VDC 4CO LD/PB**

Weidmüller Interface GmbH & Co. KG
Klingenbergstraße 26
D-32758 Detmold
Germany
Fon: +49 5231 14-0
Fax: +49 5231 14-292083
www.weidmueller.com

Accessories

ESG 6/15



Guaranteed long service life: ESG

The multi-colour and multi-format labels have a strong adhesive layer to ensure the best possible adhesion to the underlying surface. Double laminated polyester makes the basic material very thin and yet extremely tear-resistant.

Your benefits with MultiMark

- Double laminated polyester
- Can be used with equipment from many manufacturers
- Device markers with a familiar design

General ordering data

Type	ESG 6/15 MM WS	Version
Order No.	2619940000	ESG, Device markers, 6 x 15 mm, white
GTIN (EAN)	4050118626148	
Qty.	3,000 pc(s).	

ESG 6/17



Guaranteed long service life: ESG

The multi-colour and multi-format labels have a strong adhesive layer to ensure the best possible adhesion to the underlying surface. Double laminated polyester makes the basic material very thin and yet extremely tear-resistant.

Your benefits with MultiMark

- Double laminated polyester
- Can be used with equipment from many manufacturers
- Device markers with a familiar design

General ordering data

Type	ESG 6/17 MM WS	Version
Order No.	2005100000	ESG, Device markers, 6 x 17 mm, white
GTIN (EAN)	4050118390728	
Qty.	3,000 pc(s).	

Data sheet

**D-SERIES DRM
DRMKIT 220VDC 4CO LD/PB**

Weidmüller Interface GmbH & Co. KG
 Klingenbergstraße 26
 D-32758 Detmold
 Germany
 Fon: +49 5231 14-0
 Fax: +49 5231 14-292083
 www.weidmueller.com

Drawings

Miscellaneous

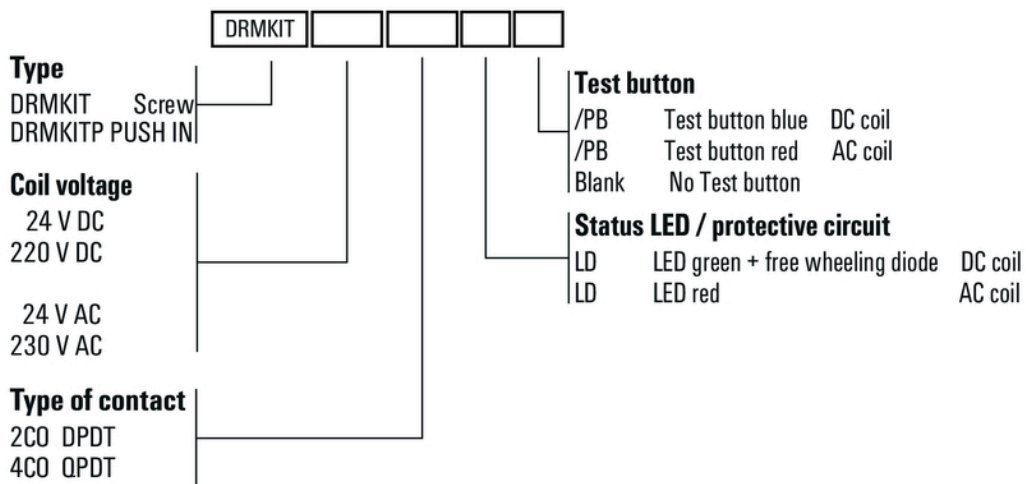

Type codes