

Title	<i>Reference Design Report for a 42 W Dual Port Isolated Flyback Power Supply with 30 W USB PD 3.0 and 12 W USB-A Port Using InnoSwitch™ 3-Pro PowiGaN™ INN3379C-H302</i>
Specification	Input: 90 VAC – 265 VAC USB Type-C Output: 5 V / 3 A, 9 V / 3 A, 12 V / 2.5 A, 15 V / 2 A, 20 V / 1.5 A, USB Type-A Output: 5 V / 2.4 A
Application	Wall Outlet, Power Strip and Surge Protectors
Author	Applications Engineering Department
Document Number	RDR-848
Date	July 28, 2020
Revision	1.2

Summary and Features

- Dual USB charging ports
 - USB Type-C receptacle with USB PD 3.0
 - USB Type-A receptacle for standard USB charging
- PowiGaN based InnoSwitch3-Pro
 - Highly integrated switcher IC with integrated high-voltage MOSFET, synchronous rectification and FluxLink™ feedback
 - PowiGaN enables compact, heat sink-less design
 - Digitally controllable CV/CC via I²C interface enables the use of cost effective 8 pin PD controller IC
- Low component count (73 pcs)
- Up to 50 °C ambient temperature operation
- Meets DOE6 efficiency requirement
- <75 mW System no-load input power
- Integrated protection and reliability features
 - Output short-circuit protection for both USB ports
 - OVP, OCP and OTP protection

PATENT INFORMATION

Power Integrations

5245 Hellyer Avenue, San Jose, CA 95138 USA.
Tel: +1 408 414 9200 Fax: +1 408 414 9201
www.power.com

The products and applications illustrated herein (including transformer construction and circuits external to the products) may be covered by one or more U.S. and foreign patents, or potentially by pending U.S. and foreign patent applications assigned to Power Integrations. A complete list of Power Integrations' patents may be found at www.power.com. Power Integrations grants its customers a license under certain patent rights as set forth at <https://www.power.com/company/intellectual-property-licensing/>.



Table of Contents

1	Introduction	6
2	Power Supply Specification	10
3	Schematic	11
3.1	Main Board Schematic.....	11
3.2	Daughter Board Schematic	12
4	Circuit Description	13
4.1	Input EMI Filter and Rectifier.....	13
4.2	InnoSwitch3-Pro Primary-Side Control Block.....	13
4.3	InnoSwitch3-Pro Secondary-Side Control Block.....	14
4.4	DC/DC Converter for USB Type-A Output Receptacle	15
5	PCB Layout	16
5.1	Main Board.....	16
5.2	Daughter Board	17
5.3	Main Board BOM.....	18
5.4	Daughter Board BOM	20
6	Power Transformer Specification (T1).....	21
6.1	Electrical Diagram.....	21
6.2	Electrical Specifications	21
6.3	Material List	21
6.4	Transformer Build Diagram	22
6.5	Winding Illustrations	23
7	Transformer (T1) Spreadsheet	30
8	Common Mode Choke Specification (L1).....	33
8.1	Electrical Diagram.....	33
8.2	Electrical Specifications	33
8.3	Material List	33
8.4	Inductor Build Diagram	33
8.5	Inductor Construction	33
9	Common Mode Choke Specification (L2).....	34
9.1	Electrical Diagram.....	34
9.2	Electrical Specifications	34
9.3	Material List	34
9.4	Inductor Build Diagram	35
9.5	Inductor Construction	35
10	Performance Data	36
10.1	System Full Load Efficiency	36
10.2	Main Flyback Full Load Efficiency w/o DC-DC Converter	37
10.3	Average System Efficiency.....	38
10.4	System Efficiency vs. Load	38
10.4.1	$V_{IN} = 115 \text{ VAC } 60 \text{ Hz}$	38
10.4.2	$V_{IN} = 230 \text{ VAC } 50 \text{ Hz}$	39
10.5	No-Load Input Power	40
10.6	Output Voltage Regulation at Full Load	41

10.6.1	USB Type-C Receptacle Output Voltage Regulation	41
10.6.2	USB Type-A Receptacle Output Voltage Regulation	42
10.7	Cross Regulation at $V_{USB-C} = 5\text{ V}$	43
10.7.1	$V_{IN} = 90\text{ VAC } 60\text{ Hz}$	43
10.7.2	$V_{IN} = 265\text{ VAC } 50\text{ Hz}$	45
10.8	Cross Regulation at $V_{USB-C} = 20\text{ V}$	47
10.8.1	$V_{IN} = 90\text{ VAC}$	47
10.8.2	$V_{IN} = 265\text{ VAC}$	49
10.9	Output Ripple Voltage.....	51
10.9.1	USB-C Receptacle Output Ripple Voltage	51
10.9.2	USB-A Receptacle Ripple Voltage	56
10.10	Transient Load Response Test Data.....	60
10.10.1	USB Type-C Transient Load Response at $V_{USB-C} = 20\text{ V}$	60
10.10.2	USB Type-C Transient Load Response at $V_{USB-C} = 5\text{ V}$	60
10.10.3	USB Type-A Transient Load Response at $V_{USB-C} = 20\text{ V}$	61
10.10.4	USB Type-A Transient Load Response at $V_{USB-C} = 20\text{ V}$	61
10.11	Overcurrent Protection.....	62
11	Thermal Performance.....	63
11.1	Thermal Scan at 25 °C Ambient.....	63
11.2	Thermal Scan Summary	63
11.2.1	90 VAC Input USB-C: 20 V / 1.5 A, USB-A: 5 V / 2.4 A	64
11.2.2	265 VAC Input USB-C: 20 V / 1.5 A, USB-A: 5 V / 2.4 A	66
11.2.3	90 VAC Input USB-C: 9 V / 3 A, USB-A: 5 V / 2.4 A.....	68
11.2.4	265 VAC Input USB-C: 9 V / 3 A, USB-A: 5 V / 2.4 A	70
11.3	Thermal Performance at 50 °C Chamber Ambient Temperature.....	72
11.3.1	Component Thermal Profile at USB-C: 20 V / 1.5 A, USB-A: 5 V / 2.4 A....	73
11.3.2	Component Thermal Profile at USB-C: 12 V / 2.5 A, USB-A: 5 V / 2.4 A....	75
11.3.3	Component Thermal Profile at USB-C: 9 V / 3 A, USB-A: 5 V / 2.4 A	77
11.3.4	OTP Test at USB-C: 20 V / 1.5 A, USB-A: 5 V / 2.4 A.....	79
12	Waveforms.....	81
12.1	Start-up Profile at USB-C 5 V / 3 A.....	81
12.2	USB-C Transient Voltage Step Change (5 V - 9 V - 12 V - 15 V - 20 V).....	81
12.3	USB-C Transient Voltage Step Change (5 V - 20 V).....	82
12.4	Transient Load Response	83
12.4.1	USB Type-C Transient Load at $V_{USB-C} = 5\text{ V}$	83
12.4.2	USB Type-C Transient Load at $V_{USB-C} = 20\text{ V}$	84
12.4.3	USB Type-A Transient Load at $V_{USB-C} = 5\text{ V}$	85
12.4.4	USB Type-A Transient Load at $V_{USB-C} = 20\text{ V}$	86
12.5	Output Ripple Voltage.....	87
12.5.1	Output Ripple Voltage at $V_{USB-C} = 5\text{ V} / 3\text{ A}$, $V_{USB-A} = 5\text{ V} / 2.4\text{ A}$	87
12.5.2	Output Ripple Voltage at $V_{USB-C} = 9\text{ V} / 3\text{ A}$, $V_{USB-A} = 5\text{ V} / 2.4\text{ A}$	88
12.5.3	Output Ripple Voltage at $V_{USB-C} = 12\text{ V} / 2.5\text{ A}$, $V_{USB-A} = 5\text{ V} / 2.4\text{ A}$	88
12.5.4	Output Ripple Voltage at $V_{USB-C} = 20\text{ V} / 1.5\text{ A}$, $V_{USB-A} = 5\text{ V} / 2.4\text{ A}$	89
12.6	Output Short-Circuit.....	89

12.6.1	USB-C Output Short-Circuit at $V_{\text{USB-C}} = 5 \text{ V}$, Full Load	89
12.6.2	USB-C Output Short-Circuit at $V_{\text{USB-C}} = 20 \text{ V}$, Full Load.....	90
12.6.3	Start-up with USB-C Output Shorted	90
12.6.4	Start-up with USB-A Output Shorted	91
12.6.5	USB-A Full Load Short at $V_{\text{USB-C}} = 5 \text{ V}$	91
12.6.6	USB-A Full Load Short at $V_{\text{USB-C}} = 20 \text{ V}$	92
12.7	Drain Voltage and Current Waveforms at $V_{\text{USB-C}} = 20 \text{ V}$	92
12.8	Drain Voltage and Current Waveforms at $V_{\text{USB-C}} = 5 \text{ V}$	93
12.9	SR FET Drain Voltage.....	94
13	Conducted EMI	96
13.1	Test Set-up	96
13.2	Equipment and Load Used.....	96
13.3	Conducted EMI at $V_{\text{USB-C}} = 20 \text{ V}$ Full Load with Output Floating.....	97
13.4	Conducted EMI at $V_{\text{USB-C}} = 12 \text{ V}$ Full Load with Output Floating.....	99
13.5	Conducted EMI at $V_{\text{USB-C}} = 5 \text{ V}$ Full Load with Output Floating	100
13.6	Conducted EMI at $V_{\text{USB-C}} = 20 \text{ V}$ Full Load, Earth Grounded	103
14	Line Immunity	105
14.1	Differential Surge Test Results.....	105
14.2	Ring Wave Surge Test Results	106
15	ESD.....	107
15.1	ESD Discharge at the End of the Output Cable	107
15.2	ESD Discharge at the End of the PCB (Output Receptacle)	108
16	Brown-Out / Brown-Out Recovery Test.....	109
16.1	Brown-Out Test at $V_{\text{USB-C}} = 5 \text{ V}$, $V_{\text{USB-A}} = 5 \text{ V}$ Full Load	109
16.2	Brown-Out Recovery Test at $V_{\text{USB-C}} = 20 \text{ V}$, $V_{\text{USB-A}} = 5 \text{ V}$ Full Load	109
17	Revision History	110

Important Note: Although this board is designed to satisfy safety isolation requirements, the engineering prototype has not been agency approved. Therefore, all testing should be performed using an isolation transformer to provide the AC input to the prototype board.

1 Introduction

This engineering report describes a 42 W dual USB port switching power supply for wall outlet and power strip pad application. The main power supply is an isolated flyback controlled by InnoSwitch3-Pro. It is designed to deliver 30 W USB PD 3.0 (USB Type-C) and at the same time, provide DC input supply for 5 V / 2.4 A output (USB Type-A) DC/DC converter.

The DER board is designed to operate at input voltage range from 90 VAC to 265 VAC.

InnoSwitch3-Pro is a highly integrated digitally controllable quasi-resonant flyback switcher IC designed for high efficiency USB PD 3.0 application. It integrates a high-voltage switch, primary and secondary side control and fluxLink feedback which simplifies the development of fully programmable, highly efficient power supplies, particularly those in compact enclosures. InnoSwitch3-Pro has built-in 3.3 V linear regulator that provides a bias supply for the microprocessor in stand-alone implementations. The IC uses the universal I²C interface that enables dynamic control of output voltage and current along with many configurable features.

DER-848 offers low component count and heat sink-less design for compact enclosure applications. The key design goals were high efficiency and compact design.

The document contains the power supply specification, schematic, bill of materials, transformer documentation, printed circuit layout, design spreadsheet, and performance data.

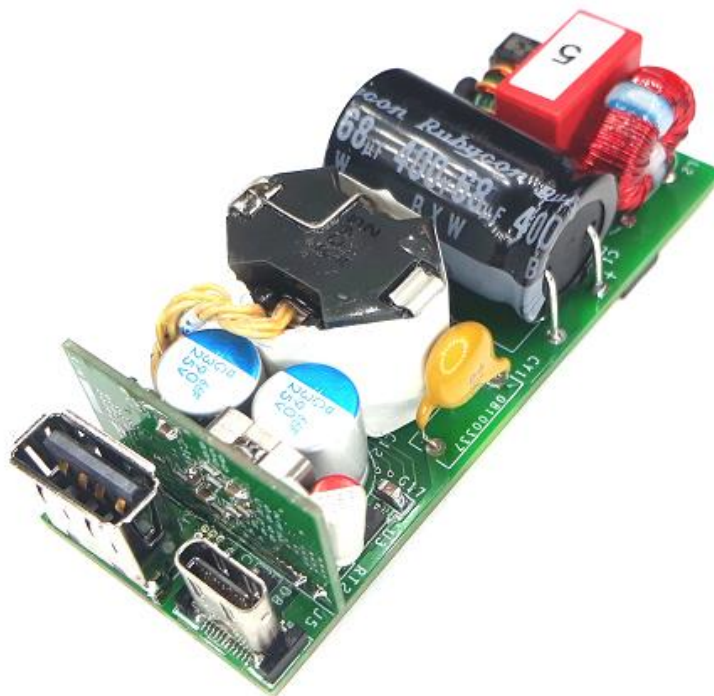

Figure 1 – Populated Circuit Board.

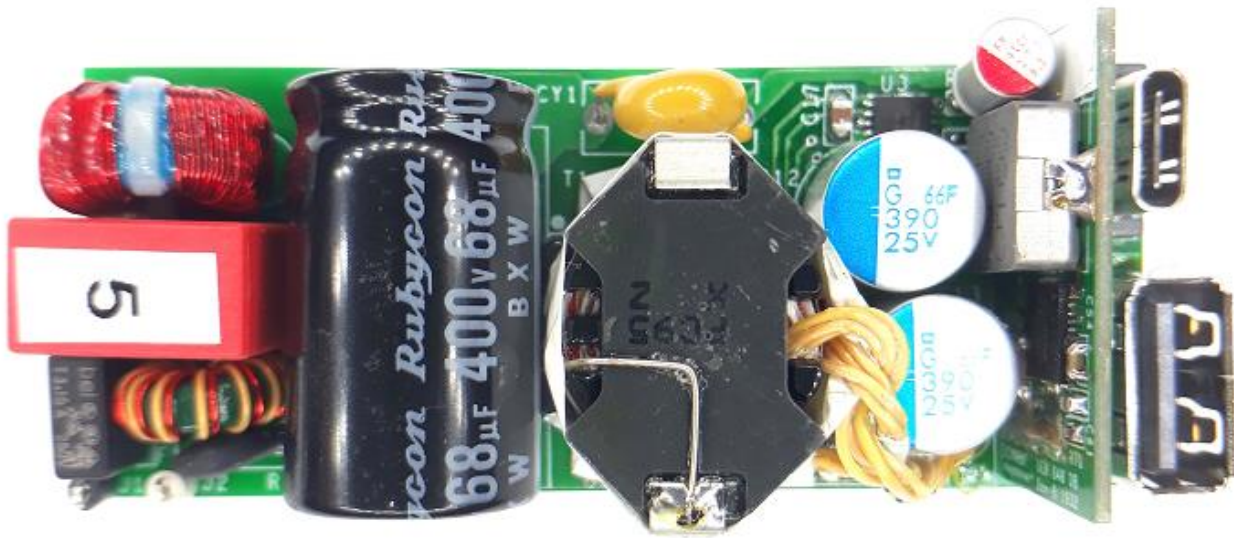

Figure 2 – Populated Circuit Board, Top View.

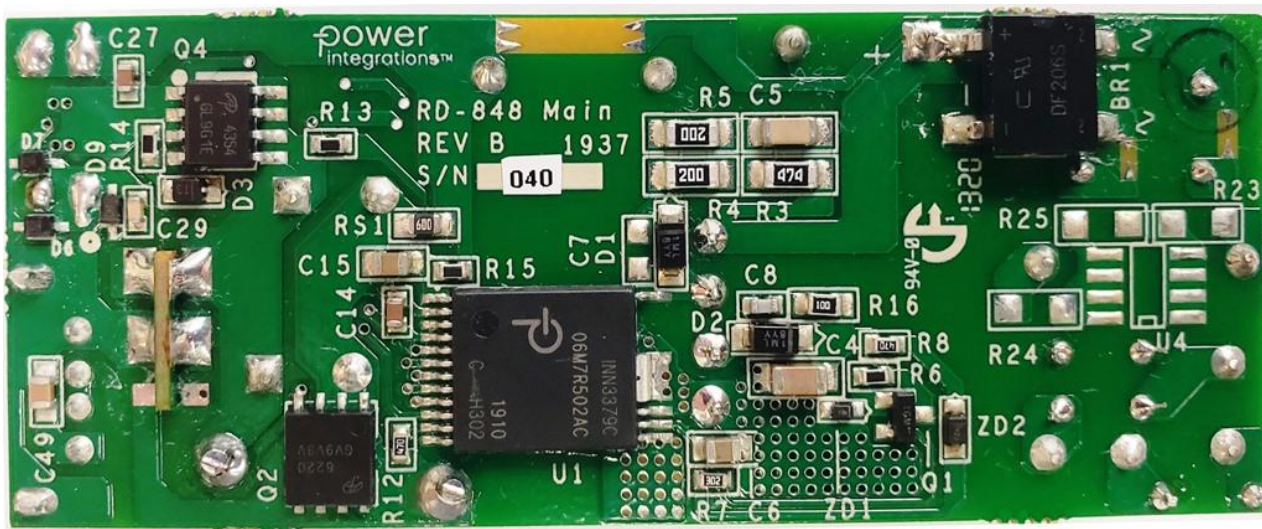

Figure 3 – Populated Circuit Board, Bottom View.



Figure 4 – Populated Daughter Board, Top View.



Figure 5 – Populated Daughter Board, Bottom View.

2 Power Supply Specification

The table below represents the minimum acceptable performance of the design. Actual performance is listed in the results section.

Description	Symbol	Min	Typ	Max	Units	Comment
Input						
Voltage	V_{IN}	90		265	VAC	2 Wire – no P.E.
Frequency	f_{LINE}	50	50/60	60	Hz	
No-load Input Power				75	mW	115 VAC and 230 VAC.
USB-C Output						
USB-C Output Voltage	V_{O-USBC}		20		V	Output Voltage measured the end of the PCB
Output Current	I_{O-USBC}		1.5		A	
Output Power	P_{O-USBC}		30		W	
Output Ripple	V_{R-USBC}			200	mV	Ripple measured with 100mΩ cable
Full Load Efficiency with USB-A	η_{FL}	88			%	115 VAC to 230 VAC.
Average Efficiency with USB-A	η_{AVE}	87			%	DOE6 Limit (84.13%)
USB-C Output						
Output Voltage	V_{O-USBC}		15		V	Output Voltage measured at the end of the PCB
Output Current	I_{O-USBC}		2.0		A	
Output Power	P_{O-USBC}		30		W	
Output Ripple	V_{R-USBC}			200	mV	Ripple measured with 100mΩ cable
Full Load Efficiency with USB-A	η_{FL}	88			%	115 VAC to 230 VAC.
Average Efficiency with USB-A	η_{AVE}	88			%	DOE6 Limit (84.13%)
USB-C Output						
Output Voltage	V_{O-USBC}		12		V	Output Voltage measured at the end of the PCB
Output Current	I_{O-USBC}		2.5		A	
Output Power	P_{O-USBC}		30		W	
Output Ripple	V_{R-USBC}			200	mV	Ripple measured with 100mΩ cable
Full Load Efficiency with USB-A	η_{FL}	88			%	115 VAC to 230 VAC.
Average Efficiency with USB-A	η_{AVE}	89			%	DOE6 Limit (84.13%)
USB-C Output						
Output Voltage	V_{O-USBC}		9		V	Output Voltage measured at the end of the PCB
Output Current	I_{O-USBC}		3		A	
Output Power	P_{O-USBC}		27		W	
Output Ripple	V_{R-USBC}			200	mV	Ripple measured with 100mΩ cable
Full Load Efficiency with USB-A	η_{FL}	88			%	115 VAC to 230 VAC.
Average Efficiency with USB-A	η_{AVE}	89			%	DOE6 Limit (83.58%)
USB-C Output						
Output Voltage	V_{O-USBC}		5		V	Output Voltage measured at PCB
Output Current	I_{O-USBC}		3		A	
Output Power	P_{O-USBC}		15		W	
Output Ripple	V_{R-USBC}			200	mV	Ripple measured with 100mΩ cable
Full Load Efficiency with USB-A	η_{FL}	86			%	115 VAC to 230 VAC.
Average Efficiency with USB-A	η_{AVE}	88			%	DOE6 Limit (80.82%)
USB-A Output						
Output Voltage	V_{O-USBA}		5		V	Output Voltage measured at the end of the PCB
Output Current	I_{O-USBA}		2.4		A	
Output Power	P_{O-USBA}		12		W	
Output Ripple	V_{R-USBA}			100	mV	Ripple measured with 100mΩ cable
Full Load Efficiency	η_{FL}	90			%	DC-DC Stand Alone
Environmental						
Conducted EMI			CISPR22B / EN55022B			Output Floating or Grounded
ESD Immunity	$\pm V_{ESD}$		15 kV			No Damage.
Combination Wave Surge	V_{SURGE}		2 kV			No Damage.
Ring Wave Surge	V_{SURGE}		2.5 kV			No Damage.
Safety			IEC950 / UL1950 Class II			Designed to Meet.



3 Schematic

3.1 Main Board Schematic

The circuit incorporates the main flyback circuit using INN3379C-H302 and the PD controller.

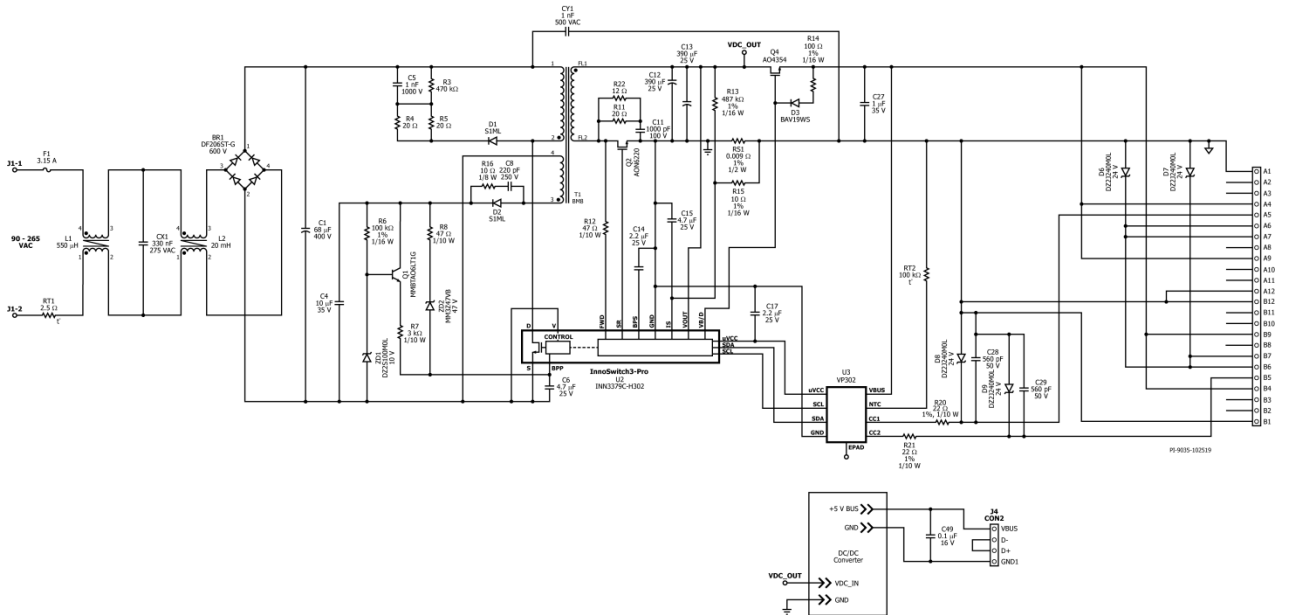

Figure 6 – Main Board Schematic.



3.2 Daughter Board Schematic

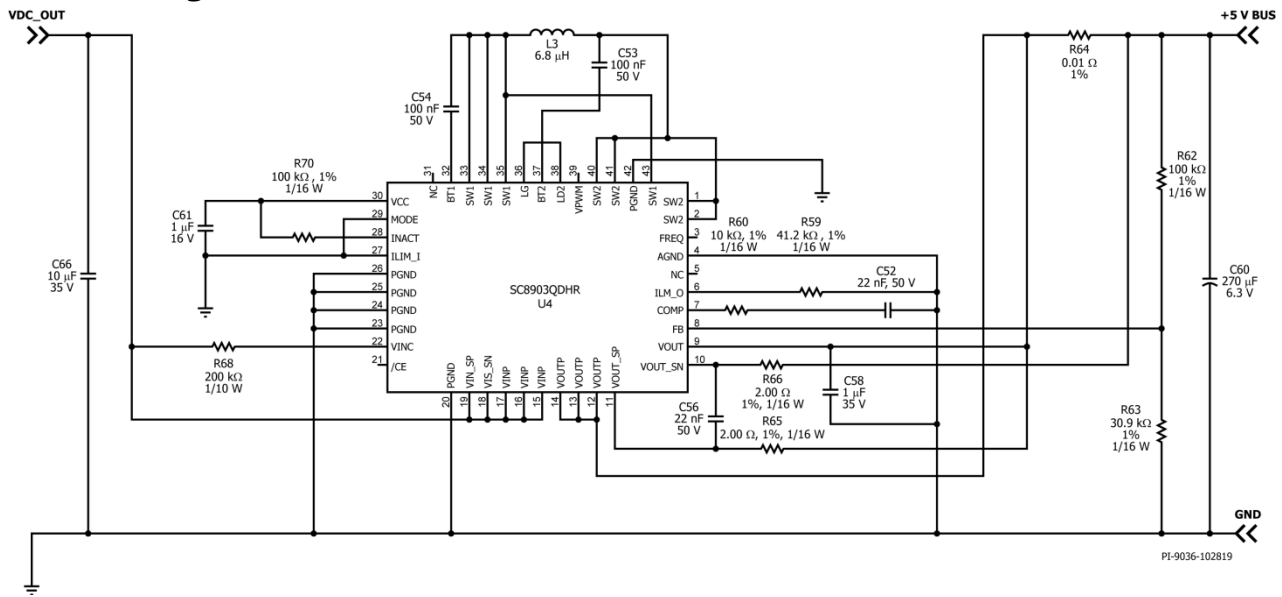

Figure 7 – Daughter Board Schematic.

4 Circuit Description

The flyback circuit is controlled by InnoSwitch3-Pro IC. The controller IC incorporates the primary and secondary side controller circuit along with a high-voltage power MOSFET in one single package.

4.1 *Input EMI Filter and Rectifier*

The input fuse (F1) provides safety protection from component failures. The AC input voltage is full wave rectified by the bridge rectifier (BR1) and then filtered by the bulk capacitor (C1). This provides a smooth DC input voltage supply to the flyback circuit. Capacitor C1, CX1, L1 and L2 provide common mode and differential mode noise filtering generated during switching actions. A low ESR electrolytic capacitor is recommended for the bulk capacitor (C1) for better differential mode noise filtering on first band frequency. Y capacitor (CY1) diverts common mode noise back to the primary where the EMI input filter is located. Thermistor (RT1) limits the inrush current when AC line is connected.

4.2 *InnoSwitch3-Pro Primary-Side Control Block*

The power transformer is designed for flyback topology power conversion. The start winding terminal (pin 3) of the transformer primary is connected to the DRAIN pin of the power MOSFET inside the InnoSwitch3-Pro while the finish terminal (pin 1) of the primary winding is connected to the positive terminal of the bulk capacitor (C1). RCD primary snubber (C5, R3, R4, R5 and D1) limits the primary DRAIN (D) to SOURCE (S) pin voltage spike caused by the transformer leakage inductance. The RCD clamp values should be optimized to achieve better efficiency and standby power.

The InnoSwitch3-Pro uses an internal high-voltage current source to charge the PRIMARY BYPASS BPP pin decoupling capacitor (C6) when AC is first applied. The BPP pin capacitor (C6) value also allows the user to program the current limit (ILIM) setting through the selection of capacitance value (0.47 μ F and 4.7 μ F for setting standard and increased ILIM settings respectively). In this design, 4.7 μ F (increased ILIM) was selected for a more optimized constant current operation at low output voltage. During normal operation, the primary-side of the IC is powered from the auxiliary winding of transformer (T1). The auxiliary winding voltage is rectified using diode D2 and filtered by the bias capacitor (C4). A linear regulator formed by resistor R6, R7, Q1 and ZD1 is needed to control the current being supplied to the PRIMARY BYPASS pin of the InnoSwitch3-Pro IC (U1) all throughout the output voltage range from 5 V to 20 V. Zener diode ZD2 and R8 provide latching drive current to the PRIMARY BYPASS pin in the event of output overvoltage. RC snubber network formed by C8 and R16 limit high frequency ringing across D2 that would otherwise radiate EMI noise.

The V pin is shorted to ground disabling the input under voltage and overvoltage functionality. This implementation reduces component count and prevents output power interruption during input voltage surge events.

4.3 ***InnoSwitch3-Pro Secondary-Side Control Block***

The secondary start terminal (FL1) of the transformer (T1) is connected to the positive terminal of output capacitor C12 and C13 while the finished terminal is connected to the DRAIN pin of the SRFET (Q2). The secondary winding voltage is rectified by the SRFET (Q2) in a quasi-resonant switching and filtered by the output capacitors C12 and C13. High leakage voltage spike across SRFET drain to source during off time is reduced through RC snubber, R11, R22 and C11.

The secondary-side block of the IC is powered from either the secondary winding forward voltage (FW) or the output voltage (VO). Capacitor C14, connected to SECONDARY BYPASS pin of InnoSwitch3-Pro IC (U1) serve as bypass capacitor for the 4.4V internal regulator. During CC operation, when the output voltage falls, the device will power itself from the secondary winding. During the on-time of the primary-side power switch, the forward voltage the secondary winding is use to charge the SECONDARY BYPASS pin decoupling capacitor C14 via FORWARD pin resistor R12 and an internal 4.4 V regulator. This allows output current regulation to be maintained down to the minimum auto-restart threshold set by the I²C interface. Below this level the unit enters auto-restart until the output load is reduced. A 47 Ω resistor is recommended for FORWARD pin resistor (R12) to ensure sufficient IC supply current.

The forward voltage sensed by FWD pin from secondary winding is also use for both handshaking and quasi-resonant timing for the SRFET (Q2), which is driven by the SYNCHRONOUS RECTIFIER DRIVE (SR) pin. The FWD pin voltage is use to determine when to turn off the SR FET in discontinuous conduction mode operation. This is when the voltage across the $R_{DS(ON)}$ of the SR FET (Q1) drops below zero volts with respect to the GND pin. In continuous conduction mode (CCM) the SR FET is turned off when the feedback pulse is sent to the primary to demand the next switching cycle, providing excellent synchronous operation, free of any overlap for the FET turn-off.

Output current is sensed by monitoring the voltage drop across resistor RS1 between the IS and SECONDARY GROUND pins. The internal constant current sense threshold is approximately 32 mV. Once the internal current sense threshold is exceeded, the device regulates the number of switch pulses to maintain a fixed output current.

Below the CC threshold, the device operates in constant voltage mode. The output voltage is set by the I²C data pulse fed by the PD controller (U3) through SDA and SCL. The PD controller gets its DC supply from the μ VCC pin of the InnoSwitch3-Pro IC. Capacitor C17 served as a decoupling capacitor for μ VCC pin.

USB PD protocol is communicated over either CC1 or CC2 line depending on the orientation in which the Type-C male receptacle is connected. N-channel FET Q4 serve as a bus switch that make the USB Type-C receptacle cold socket when no device is attached to the charger as per the USB Type-C specification. Resistor R14 and diode D3



are needed from the Source of the FET to the gate for providing a voltage discharge path when the bus switch is opened. Capacitor C27 limits high frequency noise and voltage spike caused by ESD.

4.4 ***DC/DC Converter for USB Type-A Output Receptacle***

For compact design, the DC-DC converter circuit is mounted on a daughter board. The DC input terminal is connected directly across the output capacitor C12 and C13. The DC input supply voltage level is dictated by the USB-C output voltage which is from 5 V to 20 V.

The circuit topology is a bi-directional synchronous buck-boost using SC8903QDHR from Southchip Semiconductor. It can deliver 12 W (5 V 2.4 A) from a wide DC input range from 5 V to 20 V. The topology is simple with few component counts and it only needs positive and negative Vbus supply from the main flyback to operate. Please check SC8903QDHR data sheet for more details on the circuit operation and design recommendations.

5 PCB Layout

5.1 Main Board

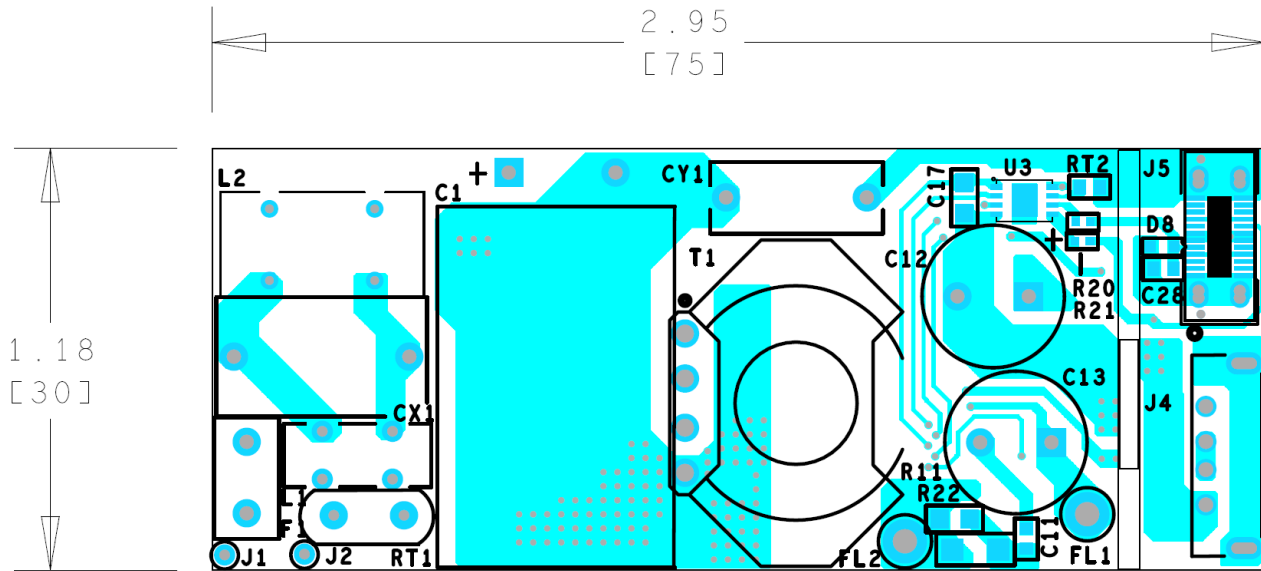

Figure 8 – Top Side.

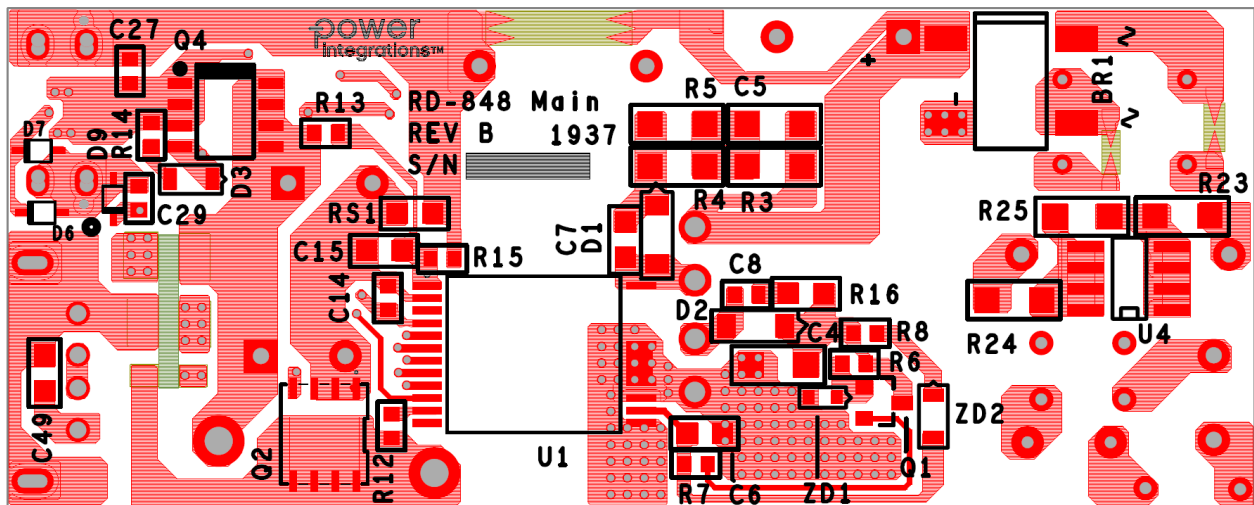

Figure 9 – Bottom Side.

5.2 **Daughter Board**

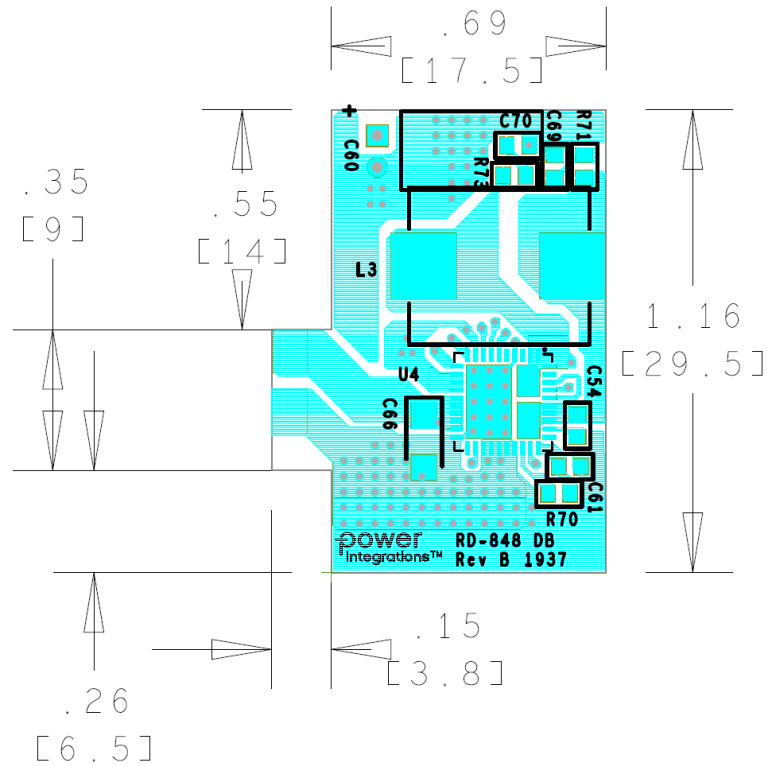

Figure 10 – Top Side.

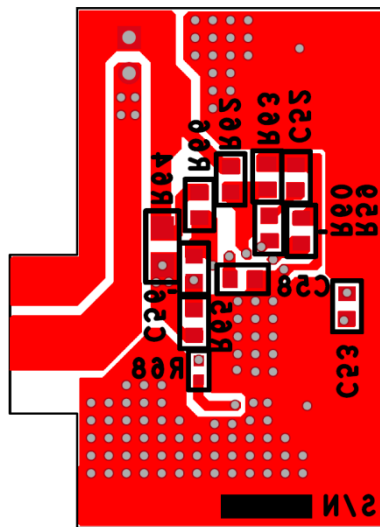

Figure 11 – Bottom Side.



Bill of Materials

5.3 Main Board BOM

Item	Qty	Ref Des	Description	Mfg Part Number	Mfg
1	1	BR1	600 V, 2 A, Bridge Rectifier, SMD, DFS	DF206ST-G	Comchip
2	1	C1	68 μ F, 400 V, Aluminum Electrolytic	400BXW68MEFR16X25	Rubycon
3	1	C4	10 μ F, 10%, 35 V, Ceramic, X7R, -55°C	CL31B106KLHNNNE	Samsung
4	1	C5	1 nF, 1000 V, Ceramic, X7R, 1206	CC1206KKX7RCBB102	Yageo
5	2	C6 C15	4.7 μ F \pm 10%, 25 V, X7R, 0805	TMK212AB7475KG-T	Taiyo Yuden
6	1	C8	220 pF, 250 V, Ceramic, COG, 0603	C1608COG2E221J	TDK
7	1	C11	1000 pF, \pm 10%, 100 V, Ceramic, X7R, 0603	C0603C102K1RACTU	Kemet
8	2	C12 C13	390 μ F, 25 V, Al Organic Polymer, Gen. Purp	APSG250ELL391MJB5S	United Chemi-Con
9	1	C14	2.2 μ F, \pm 10%, 25 V, Ceramic, X7R, 0603	GRM188Z71E225KE43D	Murata
10	1	C17	2.2 μ F, 25 V, Ceramic, X7R, 0805	C2012X7R1E225M	TDK
11	1	C27	1 μ F, \pm 10%, 35 V, Ceramic, X7R, AEC-Q200	CGA3E1X7R1V105K080AC	TDK
12	2	C28 C29	560 pF, 50V, Ceramic, X7R, 0603	CL10B561KB8NNNC	Samsung
13	1	C49	0.1 μ F, \pm 5%, 16 V, X7R, 0805	C0805C104J4RACTU	Kemet
14	1	CX1	330 nF, \pm 10%, 275 VAC, Polypropylene Film	890324024003CS	Würth
15	1	CY1	1 nF, 500 VAC, Ceramic, Y1	VY1102M35Y5UG63V0	Vishay
16	2	D1 D2	1 kV, 1 A, Standard Recovery, SMA	S1ML	TAIWAN SEMI
17	1	D3	100 V, 0.2 A, Fast Switching, 50 ns, SOD-323	BAV19WS-7-F	Diodes, Inc.
18	4	D6 D7 D8 D9	DIODE, ZENER, 24 V, 200 mW, SC-90	DZ2J240M0L	Panasonic
19	1	F1	3.15 A, 250V, Slow, RST	507-1181	Belfuse
20	1	L1	CMC, 550 μ H @ 100 kHz, Toroidal	30-00469-00	Power Integrations
21	1	L2	20 mH, Toroidal CMC, custom	32-00389-00	Power Integrations
22	1	Q1	NPN, Small Signal BJT, 80 V, 0.5 A, SOT-23	MMBTA06LT1G	On Semi
23	1	Q2	MOSFET, N-CH, 100 V, 48 A (Tc), 113.5 W	AON6220	Alpha & Omega Semi
24	1	Q4	MOSFET, N-CH, 30 V, 23 A (Ta), 3.1 W (Ta)	AO4354	Alpha & Omega Semi
25	1	R3	RES, 470 k Ω , 5%, 1/4 W, 1206	ERJ-8GEYJ474V	Panasonic
26	2	R4 R5	RES, 20 Ω , 5%, 1/4 W, 1206	ERJ-8GEYJ200V	Panasonic
27	1	R6	RES, 100 k Ω , 1%, 1/16 W, 0603	ERJ-3EKF1003V	Panasonic
28	1	R7	RES, 3 k Ω , 5%, 1/10 W, 0603	ERJ-3GEYJ302V	Panasonic
29	2	R8 R12	RES, 47 Ω , 5%, 1/10 W, 0603	ERJ-3GEYJ470V	Panasonic
30	1	R11	RES, 20 Ω , 5%, 1/8 W, 0805	ERJ-6GEYJ200V	Panasonic
31	1	R13	RES, 487 k Ω , 1%, 1/16 W, 0603	ERJ-3EKF4873V	Panasonic
32	1	R14	RES, 100 Ω , 1%, 1/16 W, 0603	ERJ-3EKF1000V	Panasonic
33	1	R15	RES, 10 Ω , 1%, 1/16 W, 0603	ERJ-3EKF10R0V	Panasonic
34	1	R16	RES, 10 Ω , 5%, 1/8 W, 0805	ERJ-6GEYJ100V	Panasonic
35	2	R20 R21	RES, 22 Ω , 1%, 1/10 W, 0402	ERJ-2RKF22R0X	Panasonic
36	1	R22	RES, 12 Ω , 5%, 1/4 W, 1206	ERJ-8GEYJ120 V	Panasonic
37	1	RS1	RES, 0.009 Ω , \pm 1%, 0.5 W, 0805	CRF0805-FZ-R009ELF	Bourns
38	1	RT1	NTC Thermistor, 2.5 Ω , 3 A	SL08 2R503	Ametherm
39	1	RT2	NTC Thermistor, 100 k Ω , 3%, 0603	NCP18WF104E03RB	Murata
40	1	T1	Bobbin, RM8, Vertical, 6 pins (4+2)	SX-813-1	Shenzhen Sanxiangyuan
41	1	U1	InnoSwitchPro, InSOP24D	INN3379C-H302	Power Integrations
42	1	U3	IC, USB PD Type-C Controller for SMPS, DFN-8	VP302	VIA Labs
43	1	ZD1	10 V, 5%, 150 mW, SSMINI-2	DZ2S100M0L	Panasonic
44	1	ZD2	DIODE, ZENER, 47 V, 200 mW, \pm 2%, SOD323F	MM3Z47VB	ON Semi

Miscellaneous Parts

Item	Qty	Ref Des	Description	Mfg Part Number	Mfg
1	1	J4	CONN, USB TYPE A 2.0, VERT, FEMALE, PCB 4 POS	SS-52100-002	Stewart Connector
2	1	J5	Connector, USB - C, USB 3.1, 10 pin, Through Hole	DX07S024WJ3R400	JAE Electronics



5.4 **Daughter Board BOM**

Item	Qty	Ref Des	Description	Mfg Part Number	Mfg
1	2	C52 C56	22 nF 50 V, Ceramic, X7R, 0603	C1608X7R1H223K	TDK
2	2	C53 C54	100 nF, $\pm 10\%$, 50 V, Ceramic, X7R, 0603	GCM188R71H104KA57J	Murata
3	1	C58	1 μ F, $\pm 10\%$, 35 V, Ceramic, X7R, 0603	CGA3E1X7R1V105K080AC	TDK
4	1	C60	270 μ F, 6.3 V, Electrolytic, (5 x 9)	RNE0J271MDS1	Nichicon
5	1	C61	1 μ F, $\pm 20\%$, 16 V, Ceramic, X7R	C0603X105M4RAC7867	Kemet
6	1	C66	10 μ F, 10%, 35 V, Ceramic, X7R 1206	CL31B106KLHNNNE	Samsung
7	1	L3	6.8 μ H, Shielded, Molded, Inductor, 8.5 A	104CDMCCDS-6R8MC	Sumida America
8	1	R59	RES, 41.2 k Ω , 1%, 1/16 W 0603	ERJ-3EKF4122V	Panasonic
9	1	R60	RES, 10 k Ω , 1%, 1/16 W, 0603	ERJ-3EKF1002V	Panasonic
10	2	R62 R70	RES, 100 k Ω , 1%, 1/16 W, 0603	ERJ-3EKF1003V	Panasonic
11	1	R63	RES, 30.9 k Ω , 1%, 1/16 W, 0603	ERJ-3EKF3092V	Panasonic
12	1	R64	RES, 0.01 Ω , 0.4 W, 1%, 0805	PF0805FRM7W0R01L	Yageo
13	2	R65 R66	RES, 2.00 Ω , 1%, 1/16 W, , 0603	RC0603FR-072RL	Panasonic
14	1	R68	RES, 200 k Ω , 5%, 1/10 W, 0402	ERJ-2GEJ204X	Panasonic
15	1	U4	IC, REG, High Efficiency, Synchronous,	SC8903QDHR	Southchip Semi

6 Power Transformer Specification (T1)

6.1 Electrical Diagram

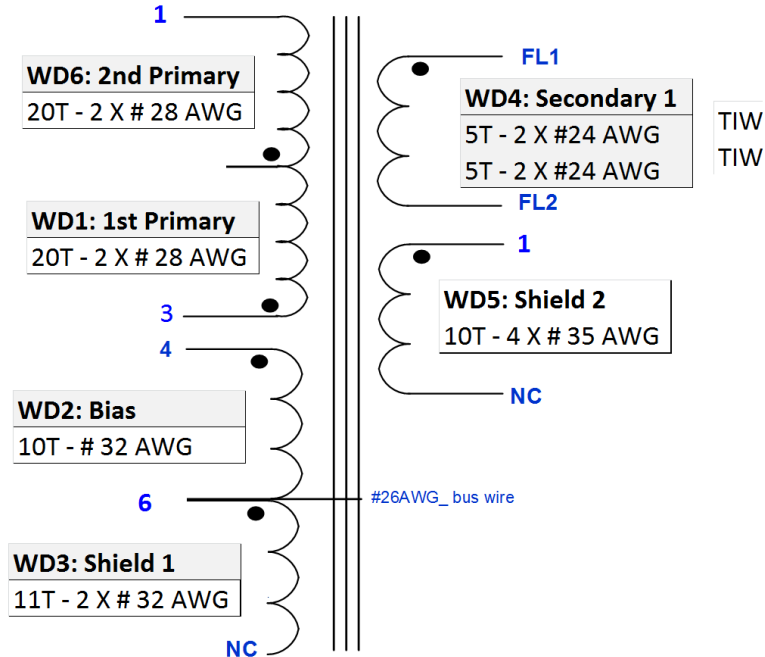

Figure 12 – Transformer Electrical Diagram.

6.2 Electrical Specifications

Parameter	Condition	Spec.
Nominal Primary Inductance	Measured at 1-10 V_{PK-PK} , 100 kHz switching frequency, between pin 1 and pin 3, with all other windings open.	373 μ H
Tolerance	Tolerance of Primary Inductance.	$\pm 7\%$
Leakage Inductance	Short all bias windings and secondary windings. Measured at 1 V_{PK-PK} , 100 kHz switching frequency, across pin 1 and pin 3.	<7 μ H

6.3 Material List

Item	Description
[1]	Core: RM8 PC95 or Equivalent.
[2]	Bobbin, RM8, Vertical, 6 pins (4+2). Part No. : 25-01163-00.
[3]	Magnet Wire: #28 AWG.
[4]	Magnet Wire: #32 AWG.
[5]	Magnet Wire: #35 AWG.
[6]	TIW Wire: #24 AWG.
[7]	Polyester Tape 8 mm.
[8]	Polyester Tape 36 mm.
[9]	RM8 Clip.

6.4 **Transformer Build Diagram**

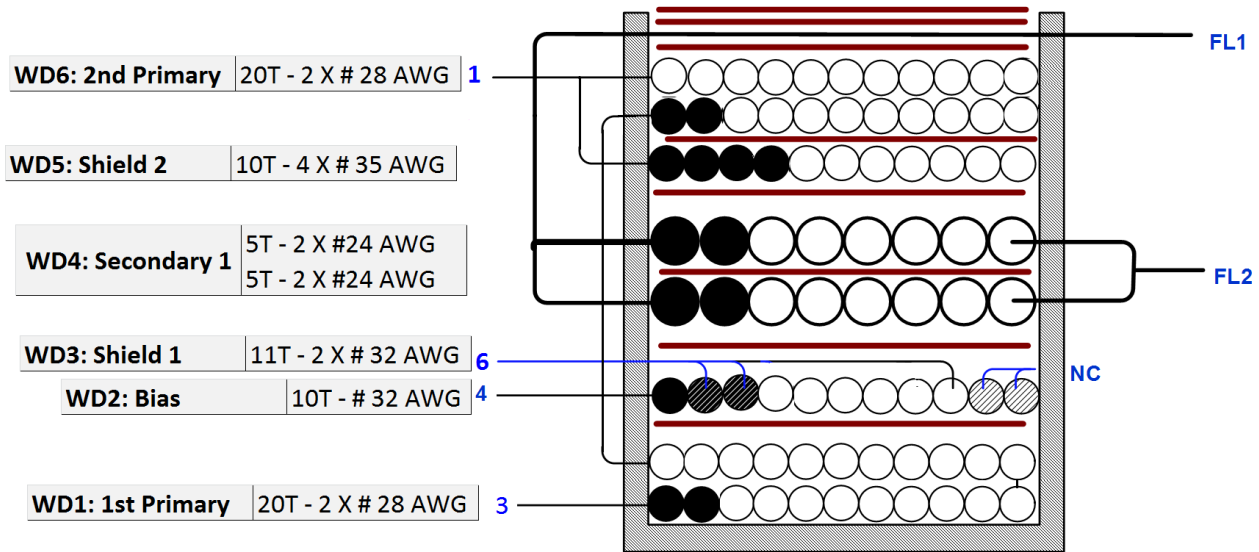

Figure 13 – Transformer Build Diagram.

6.5 *Winding Illustrations*

Winding Directions

Bobbin is oriented on winder jig such that terminal Pin 1- 6 are in the left side facing upward. The winding direction is clockwise.

Winding 1- 1st Primary

Use magnetic wire, Item [3]. Prepare two (bifilar) wires. Start at Pin 3 and wind 20 turns (Bifilar) evenly for 2 layers.

Set aside around 1m long wire extension on the left side of the winding jig and cut the wire. This remaining magnetic wire is for Winding 6.

Insulation

Apply 1 layer of polyester tape, Item [7] for insulation

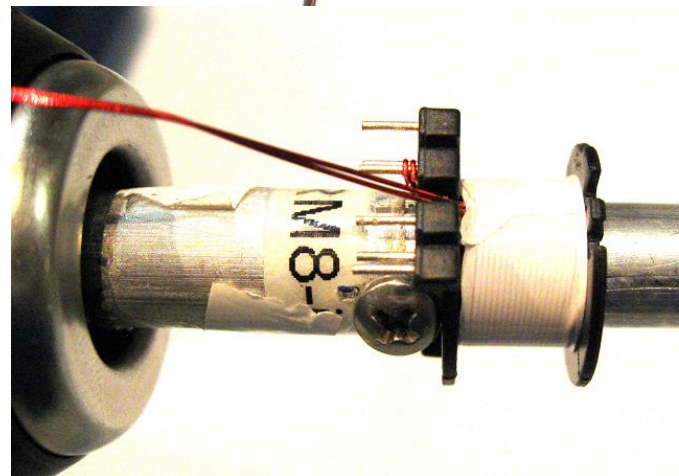
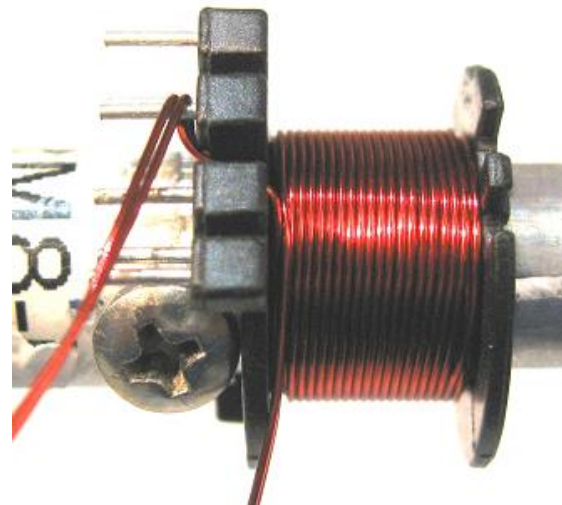
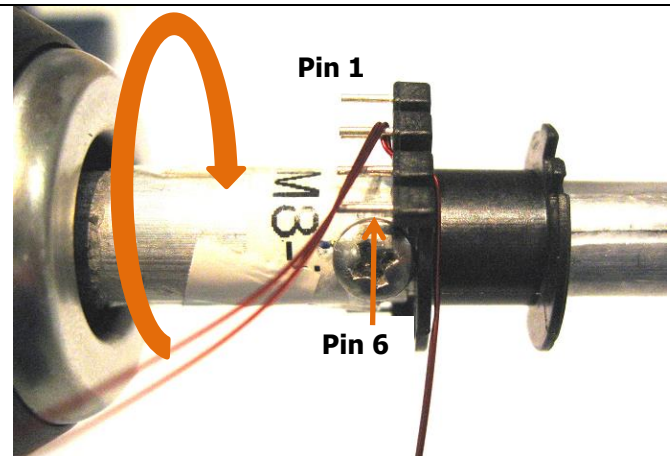

Winding 2 and 3 – Bias and shield 1

Use magnetic wire, Item [4] - AWG#32 for winding 2 and 3. Prepare single wire for winding 2 and two (bifilar) wires for winding 3. For Winding 2, start at pin 4 while for winding 3, start at pin 6.

Wind 10 turns for windings 2 and 3 evenly together from left to right.

For winding 2, Finish the winding back to the left on Pin 6.

For winding 3, add 1 more turn to make it 11 turns and cut the finish terminal as shown in the figure.

Insulation

Apply 1 layer of polyester tape, Item [7] for insulation

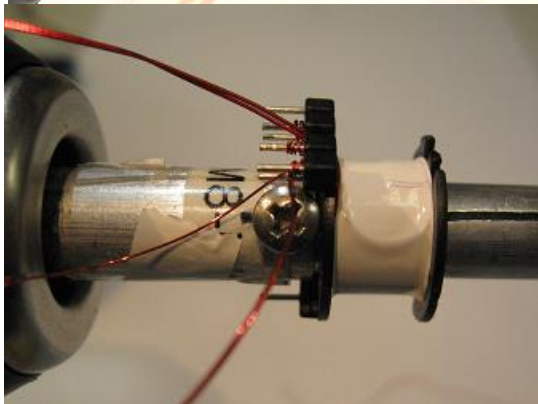
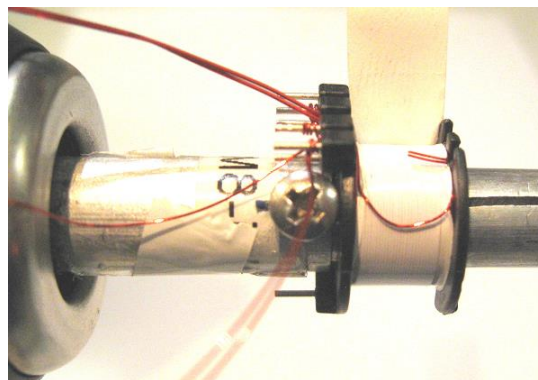
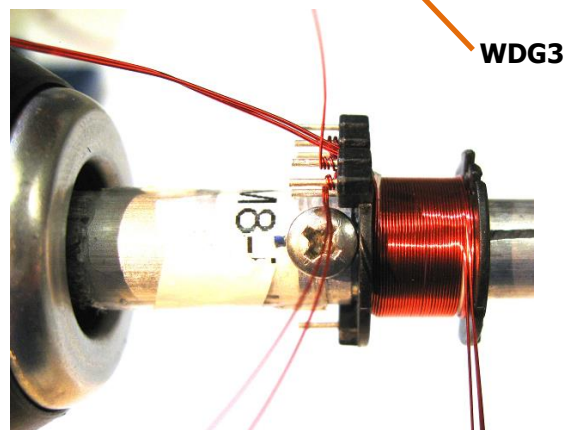
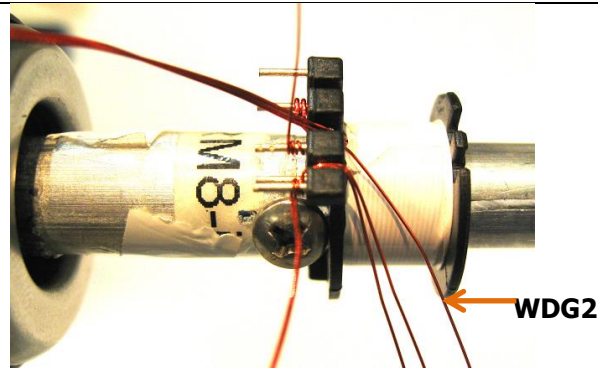

Winding 4- Secondary Winding

Position the bobbin so that Pin 7 and 8 are facing upward. Use TIW wire Item [6] – TIW AWG#24. Prepare 2 (Bifilar) wires for the first layer. Secure 70 mm fly lead (FL1) extension on the left side and wind 5 turns evenly from left to right for 1 layer. Fix the finish fly lead terminal (FL2) on the right side of the jig and cut with around 60mm wire extension.

Apply 1 layer of polyester tape, Item [6] to fix the first layer of winding 4.

Prepare another 2 (Bifilar) wires for the second layer. Secure 70 mm fly lead (FL1) extension on the left side and wind 5 turns evenly from left to right for 1 layer. Fix the finish fly lead terminal (FL2) on the right side of the jig and cut with around 60mm wire extension.

Insulation

Apply 1 layer of polyester tape, Item [7] for insulation

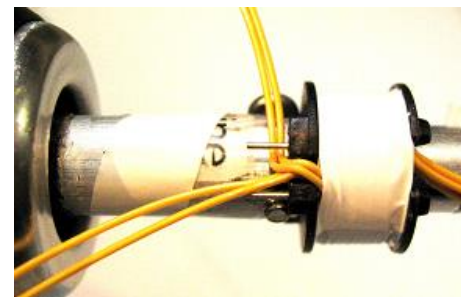
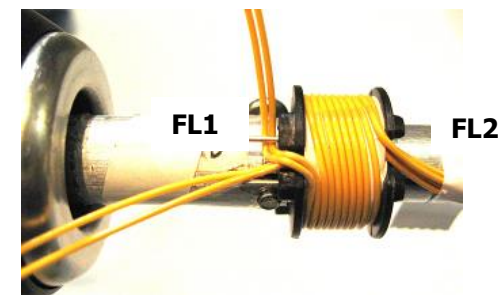
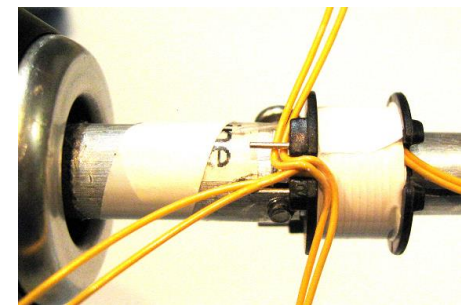
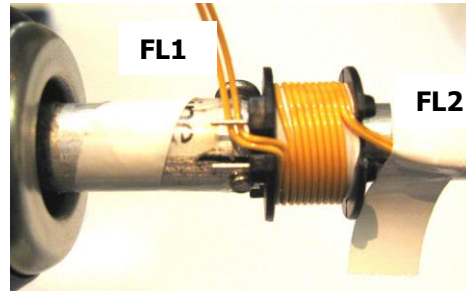
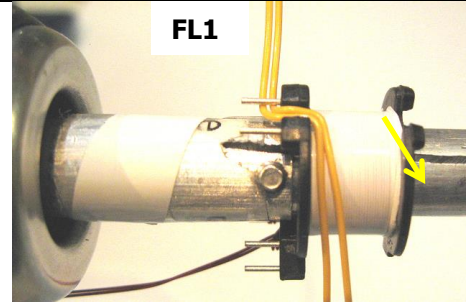

Winding 5- Shield 2

Use magnetic wire, Item 5 - AWG#35.
Prepare 4 wires (quadrifilar). Start at Pin 1
and wind 10 turns evenly for 1 layer.

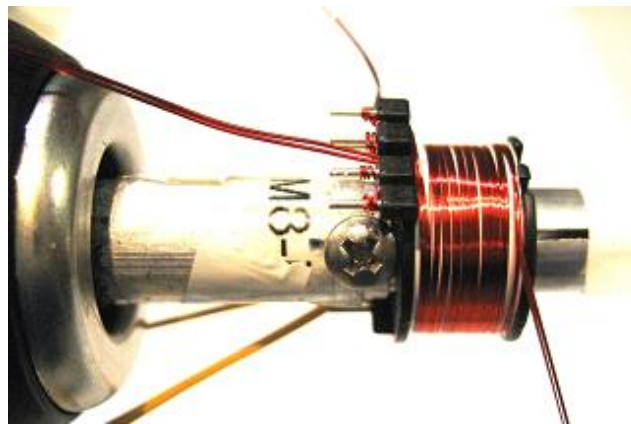
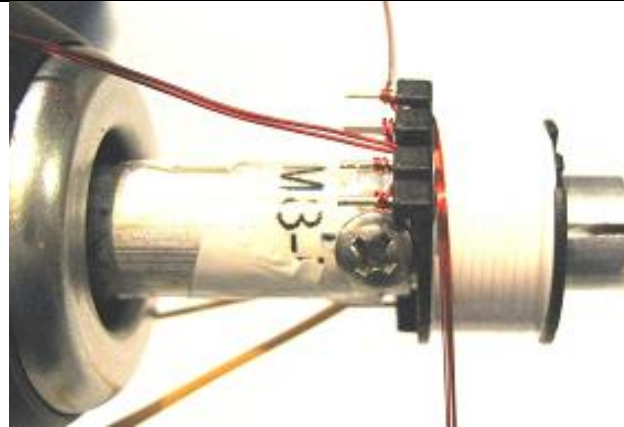

Finish the winding at the right side of the bobbin and cut the wire as shown in the figure.

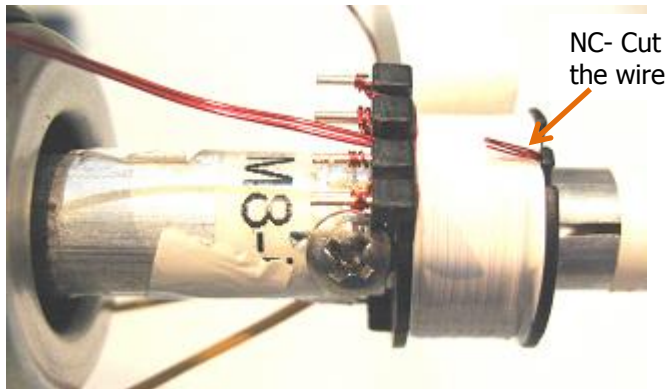

Insulation

Apply 1 layer of polyester tape, Item [7]
for insulation

Winding 5- 2nd Primary

Use the remaining wires set aside from winding 1. Start at the middle of the bobbin and wind 20 turns evenly for 2 layers. Finish the winding on Pin 1.

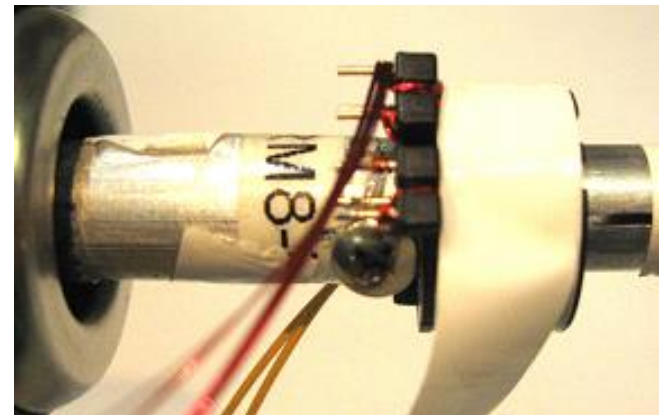
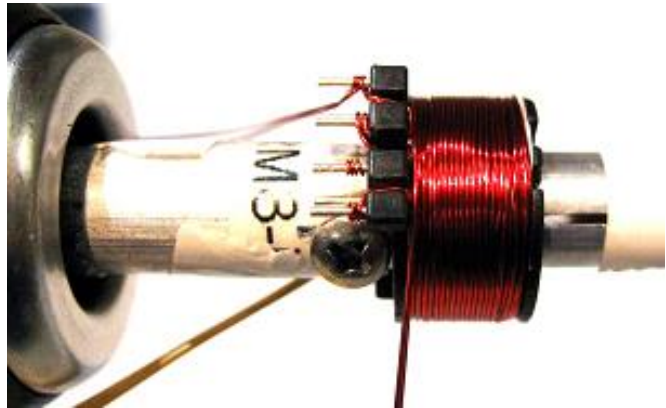
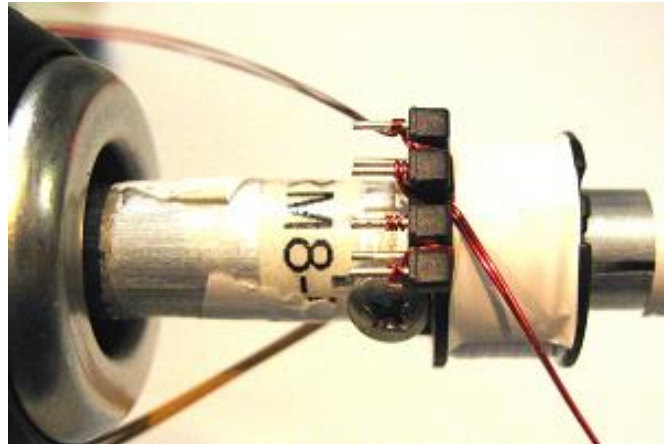
**Insulation**

Apply 1 layer of polyester tape, Item [7] for insulation

Secondary Wire

Fold the secondary fly lead wires (FL1) from left to right as shown in the figure.

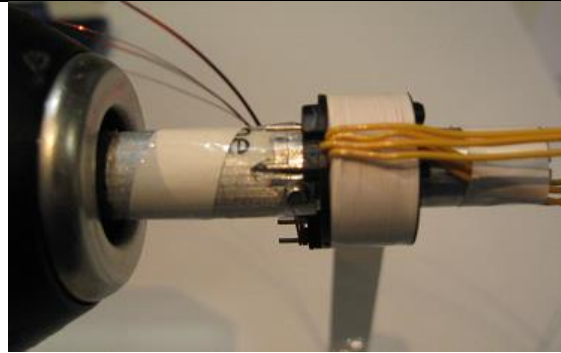

Apply 2 layers of polyester tape (item 7) to fix the Secondary fly lead wire (FL1).

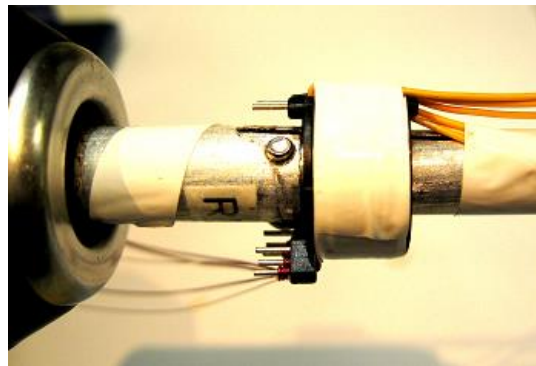

Core Fixing and Varnishing

Grind the center leg of the core until it meets the desired inductance (373 uH measured at 100kHz between pin 1 and 3). Use RM8 clip (item 9) to fix the top and bottom cores.

Note: The terminal pins of the RM8 Clip must be oriented on the top core facing upward (Upside down). This is to avoid piercing the safety insulation tape around the core. Cut the unused RM8 Clip pins

Add Core termination as shown in the figure and connect to Pin 6

Varnish the transformer and removed the unused pins 2, 5 7 and 8

Clip terminal Pins must be oriented here facing upward (upside down).

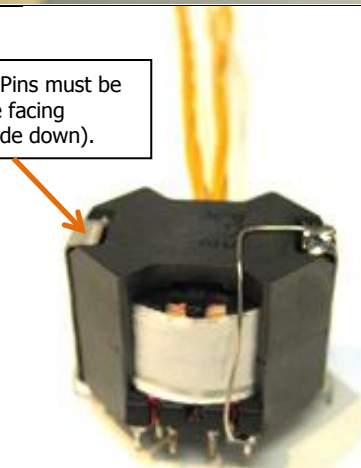

Safety Insulation Tape

Apply 2 layers polyester tape around the transformer as shown in the figure for reinforce safety insulation between core and secondary components.

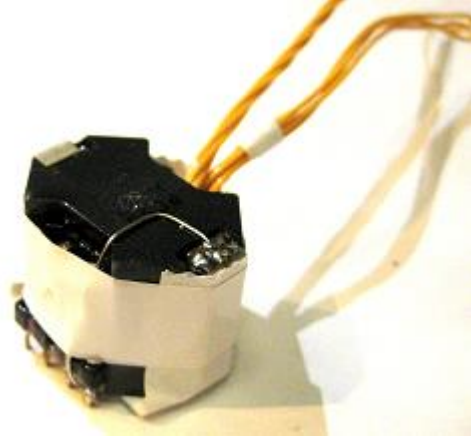

7 Transformer (T1) Spreadsheet

1	ACDC_InnoSwitch3-Pro_Flyback_072619; Rev.1.3; Copyright Power Integrations 2018	INPUT	INFO	OUTPUT	UNITS	InnoSwitch3-Pro Flyback Design Spreadsheet
2	APPLICATION VARIABLES					
3	VAC_MIN	90		90	V	Minimum AC line voltage
4	VAC_MAX			265	V	Maximum AC input voltage
5	VAC_RANGE			UNIVERSAL		AC line voltage range
6	FLINE			60	Hz	AC line voltage frequency
7	CAP_INPUT	68.0		68.0	uF	Input capacitance
9	SET-POINT 1					
10	VOUT1	20.00		20.00	V	Output voltage 1, should be the highest output voltage required
11	IOUT1	2.200		2.200	A	Output current 1
12	POUT1			44.00	W	Output power 1
13	EFFICIENCY1	0.90		0.90		Converter efficiency for output 1
14	Z_FACTOR1	0.50		0.50		Z-factor for output 1
16	SET-POINT 2					
17	VOUT2	15.00		15.00	V	Output voltage 2
18	IOUT2	2.940		2.940	A	Output current 2
19	POUT2			44.10	W	Output power 2
20	EFFICIENCY2	0.90		0.90		Converter efficiency for output 2
21	Z_FACTOR2	0.50		0.50		Z-factor for output 2
23	SET-POINT 3					
24	VOUT3	12.00		12.00	V	Output voltage 3
25	IOUT3	3.670		3.670	A	Output current 3
26	POUT3			44.04	W	Output power 3
27	EFFICIENCY3	0.90		0.90		Converter efficiency for output 3
28	Z_FACTOR3	0.50		0.50		Z-factor for output 3
30	SET-POINT 4					
31	VOUT4	9.00		9.00	V	Output voltage 4
32	IOUT4	4.500		4.500	A	Output current 4
33	POUT4			40.50	W	Output power 4
34	EFFICIENCY4	0.90		0.90		Converter efficiency for output 4
35	Z_FACTOR4	0.50		0.50		Z-factor for output 4
37	SET-POINT 5					
38	VOUT5	5.00		5.00	V	Output voltage 5
39	IOUT5	5.500		5.500	A	Output current 5
40	POUT5			27.50	W	Output power 5
41	EFFICIENCY5	0.88		0.85		Converter efficiency for output 5
42	Z_FACTOR5	0.5		0.50		Z-factor for output 5
73	VOLTAGE_CDC	0.000		0.000	V	Cable drop compensation desired at full load
77	PRIMARY CONTROLLER SELECTION					
78	ENCLOSURE	ADAPTER		ADAPTER		Power supply enclosure
79	ILIMIT_MODE	INCREASED		INCREASED		Device current limit mode
80	VDRAIN_BREAKDOWN	750		750	V	Device breakdown voltage
81	DEVICE_GENERIC	AUTO		INN33X9		Device selection
82	DEVICE_CODE			INN3379C		Device code
83	PDEVICE_MAX			65	W	Device maximum power capability
84	RDSON_25DEG			0.44	Ω	Primary switch on-time resistance at 25°C
85	RDSON_100DEG			0.62	Ω	Primary switch on-time resistance at 100°C
86	ILIMIT_MIN			1.980	A	Primary switch minimum current limit
87	ILIMIT_TYP			2.130	A	Primary switch typical current limit
88	ILIMIT_MAX			2.279	A	Primary switch maximum current limit
89	VDRAIN_ON_PRSW			0.36	V	Primary switch on-time voltage drop
90	VDRAIN_OFF_PRSW			603.31	V	Peak drain voltage on the primary switch during turn-off



94 WORST CASE ELECTRICAL PARAMETERS						
95	FSWITCHING_MAX	74000		74000	Hz	Maximum switching frequency at full load and the valley of the minimum input AC voltage
96	VOR	160.0		160.0	V	Voltage reflected to the primary winding (corresponding to set-point 1) when the primary switch turns off
97	VMIN	80.00	Info	80.00	V	A manual overwrite of VMIN voids the value of input capacitor calculated by the tool or manually entered by the user and will be used for all calculations
98	KP			0.757		Measure of continuous/discontinuous mode of operation
99	MODE_OPERATION			CCM		Mode of operation
100	DUTYCYCLE			0.620		Primary switch duty cycle
101	TIME_ON			10.49	us	Primary switch on-time
102	TIME_OFF			5.33	us	Primary switch off-time
103	LPRIMARY_MIN			347.5	uH	Minimum primary magnetizing inductance
104	LPRIMARY_TYP			373.6	uH	Typical primary magnetizing inductance
105	LPRIMARY_TOL	7.0		7.0	%	Primary magnetizing inductance tolerance
106	LPRIMARY_MAX			399.8	uH	Maximum primary magnetizing inductance
108 PRIMARY CURRENT						
109	I AVG_PRIMARY			0.585	A	Primary switch average current
110	I PEAK_PRIMARY			2.129	A	Primary switch peak current
111	I PEDESTAL_PRIMARY			0.436	A	Primary switch current pedestal
112	I RIPPLE_PRIMARY			2.129	A	Primary switch ripple current
113	I RMS_PRIMARY			0.911	A	Primary switch RMS current
115 SECONDARY CURRENT						
116	I PEAK_SECONDARY			17.032	A	Secondary winding peak current
117	I PEDESTAL_SECONDARY			3.484	A	Secondary winding pedestal current
118	I RMS_SECONDARY			7.974	A	Secondary winding RMS current
119	I RIPPLE_CAP_OUT			5.774	A	Output capacitor ripple current
123 TRANSFORMER CONSTRUCTION PARAMETERS						
124 CORE SELECTION						
125	CORE	RM8	Info	RM8		The transformer windings may not fit: pick a bigger core or bobbin and refer to the Transformer Parameters tab for fit calculations
126	CORE NAME			B65811J0000R095		Core code
127	AE			64.0	mm ²	Core cross sectional area
128	LE			38.0	mm	Core magnetic path length
129	AL			4100	nH	Ungapped core effective inductance per turns squared
130	VE			2430	mm ³	Core volume
131	BOBBIN NAME			B65812N1012D001		Bobbin name
132	AW			30.0	mm ²	Bobbin window area
133	BW			10.03	mm	Bobbin width
134	MARGIN			0.0	mm	Bobbin safety margin
136 PRIMARY WINDING						
137	NPRIMARY			40		Primary winding number of turns
138	BPEAK			3643	Gauss	Peak flux density
139	BMAX			3262	Gauss	Maximum flux density
140	BAC			1631	Gauss	AC flux density (0.5 x Peak to Peak)
141	ALG			234	nH	Typical gapped core effective inductance per turns squared
142	LG			0.325	mm	Core gap length
143	LAYERS_PRIMARY			2		Primary winding number of layers
144	AWG_PRIMARY			26		Primary wire gauge
145	OD_PRIMARY_INSULATED			0.465	mm	Primary wire insulated outer diameter

146	OD_PRIMARY_BARE			0.405	mm	Primary wire bare outer diameter
147	CMA_PRIMARY			279.0	Cmils/A	Primary winding wire CMA
149	SECONDARY WINDING					
150	NSECONDARY	5		5		Secondary winding number of turns
151	AWG_SECONDARY			18		Secondary wire gauge
152	OD_SECONDARY_INSULATED			1.328	mm	Secondary wire insulated outer diameter
153	OD_SECONDARY_BARE			1.024	mm	Secondary wire bare outer diameter
154	CMA_SECONDARY			203.7	Cmils/A	Secondary winding wire CMA
156	BIAS WINDING					
157	NBIAS			10		Bias winding number of turns
161	PRIMARY COMPONENTS SELECTION					
162	LINE UNDERVOLTAGE					
163	BROWN-IN REQUIRED			72.00	V	Required line brown-in threshold
164	RLS			3.56	MΩ	Connect two 1.78 MOhm resistors to the V-pin for the required UV/OV threshold
165	BROWN-IN ACTUAL			71.40	V	Actual brown-in threshold using standard resistors
166	BROWN-OUT ACTUAL			64.58	V	Actual brown-out threshold using standard resistors
168	LINE OVERVOLTAGE					
169	OVERVOLTAGE_LINE		Warning	297.50	V	The device voltage stress will be higher than 650V when overvoltage is triggered
171	BIAS WINDING					
172	VBIAS			9.00	V	Rectified bias voltage at the lowest output set-point
173	VF_BIAS			0.70	V	Bias winding diode forward drop
174	VREVERSE_BIASDIODE			102.33	V	Bias diode reverse voltage (not accounting parasitic voltage ring)
175	CBIAS			22	uF	Bias winding rectification capacitor
176	CBPP			4.70	uF	BPP pin capacitor
180	SECONDARY COMPONENTS SELECTION					
181	RECTIFIER					
182	VDRAIN_OFF_SRFET			66.66	V	Secondary rectifier reverse voltage (not accounting parasitic voltage ring)
183	SRFET	AUTO		SIR804DP		Secondary rectifier (Logic MOSFET)
184	VBREAKDOWN_SRFET			100	V	Secondary rectifier breakdown voltage
185	RDSON_SRFET			10.3	mΩ	SRFET on time drain resistance at 25degC for VGS=4.4V



8 Common Mode Choke Specification (L1)

8.1 Electrical Diagram

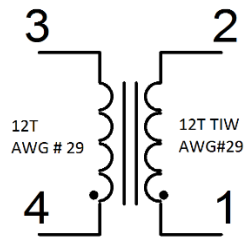

Figure 14 – Inductor Electrical Diagram.

8.2 Electrical Specifications

Parameter	Condition	Spec.
Nominal Primary Inductance	Measured at 1 V _{PK-PK} , 100 kHz switching frequency, between pin 1 and pin 3 or pin 2 and pin 4 with all other windings open.	550 μ H
Tolerance	Tolerance of Primary Inductance.	$\pm 20\%$

8.3 Material List

Item	Description
[1]	Toroid Core: 32-00330-00 (Green Color)
[2]	Magnet Wire: #29 AWG.
[3]	TIW Wire: #29 AWG.

8.4 Inductor Build Diagram

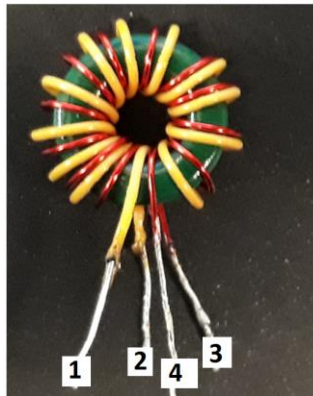

Figure 15 – Inductor Build Diagram.

8.5 Inductor Construction

1. Winding 1 - Wind 12 turns of item 2 and 3 in bifilar wound as shown in above figure.

9 Common Mode Choke Specification (L2)

9.1 Electrical Diagram

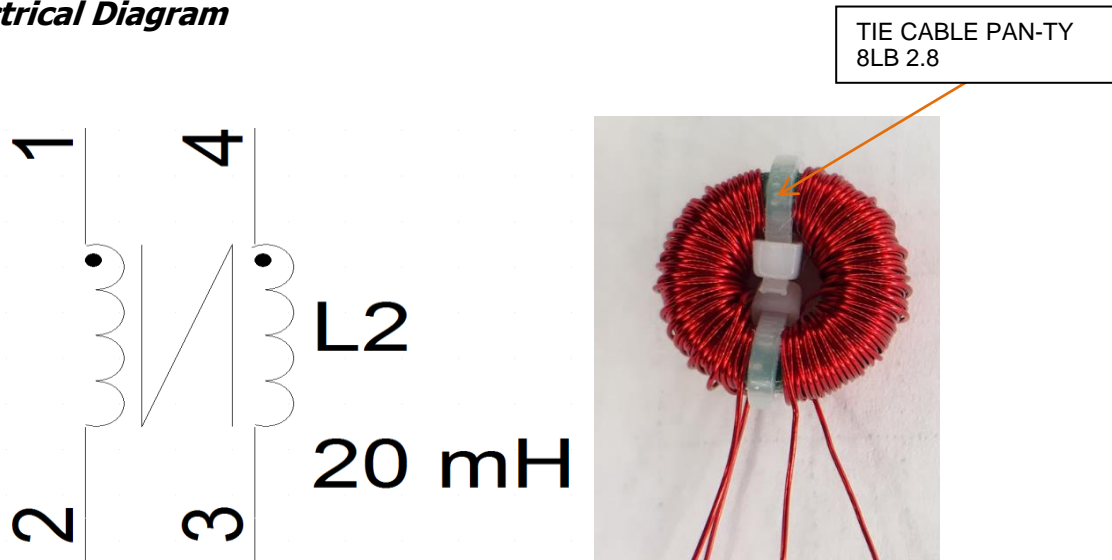

Figure 16 – Inductor Electrical Diagram.

9.2 Electrical Specifications

Parameter	Condition	Spec.
Nominal Primary Inductance	Measured at 1 V _{PK-PK} , 100 kHz switching frequency, between pin 1 and pin 3 or pin 2 and pin 4 with all other windings open.	20 mH
Tolerance	Tolerance of Primary Inductance.	±20%

9.3 Material List

Item	Description
[1]	Toroid Core: 32-00350-00 (Light Blue Color)
[2]	Magnet Wire: #29 AWG.
[3]	TIE CABLE : 75-00202-00

9.4 ***Inductor Build Diagram***

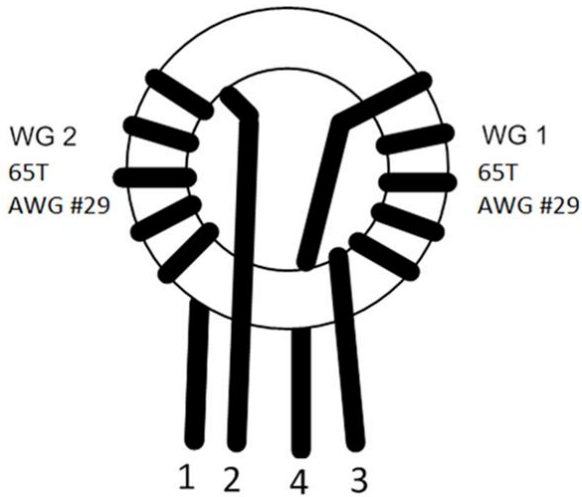

Figure 17 – Inductor Build Diagram.

9.5 ***Inductor Construction***

2. Winding 1 - Wind 65 turns of item 2 as shown in above figure.
3. Winding 2 - Wind 65 turns of item 2 as shown in above figure.
4. Apply Varnish

10 Performance Data

All measurements were performed at room temperature.

Note: The E-load Von point loading set-up for the USB Type-A is 3V to be able to power up at full load start-up.

10.1 System Full Load Efficiency

Unit was tested with the 2 output receptacle at full load condition. Output voltage was measured at the end of PCB where the output receptacles were connected. See below table for different loading conditions.

Loading Condition	CC Mode Load	
	USB-A	USB-C
USB-C 5 V	5 V/2.4 A	5 V/3 A
USB-C 9 V		9 V/3 A
USB-C 12 V		12 V/2.5 A
USB-C 15 V		15 V/2A
USB-C 20 V		20 V/1.5 A

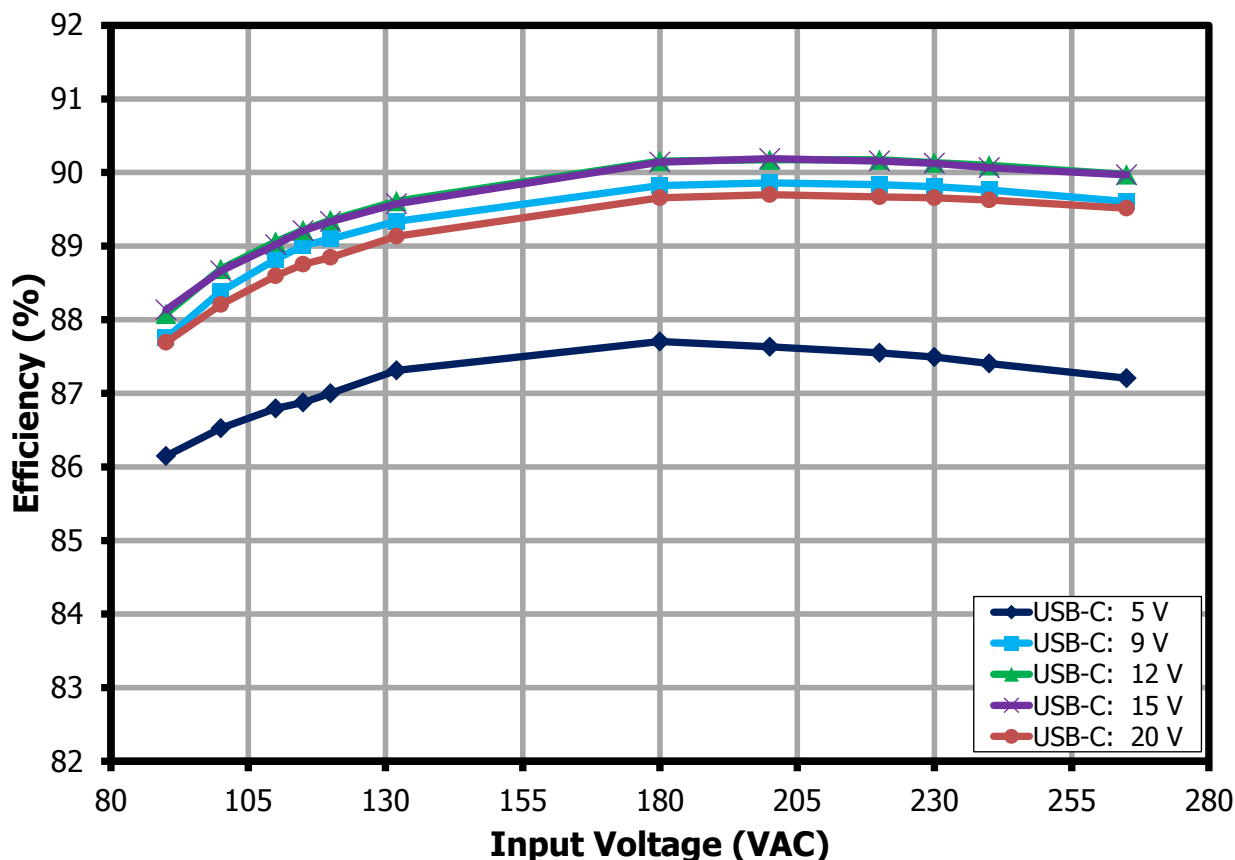

Figure 18 – System Full Load Efficiency vs. Line.

10.2 Main Flyback Full Load Efficiency w/o DC-DC Converter

Unit was tested with the daughter board removed from the main board. 2 E-load load channels were used with the first channel connected across +VBUS to GND while the second channel was connected on USB Type-C receptacle. See below load setting

Output Terminal	Output Loading Set-up				
	USB-C 5 V	USB-C 9 V	USB-C 12 V	USB-C 15 V	USB-C 20 V
CH1: VBUS/GND	5 V / 2.8 A	9 V / 1.56 A	12 V / 1.17 A	15 V / 0.94 A	20 V / 0.7 A
CH2: USB-C Receptacle	5 V / 3 A	9 V / 3 A	12 V / 2.5 A	15 V / 2 A	20 V / 1.5 A
Total Output Power	44 W	44 W	44 W	41 W	29 W

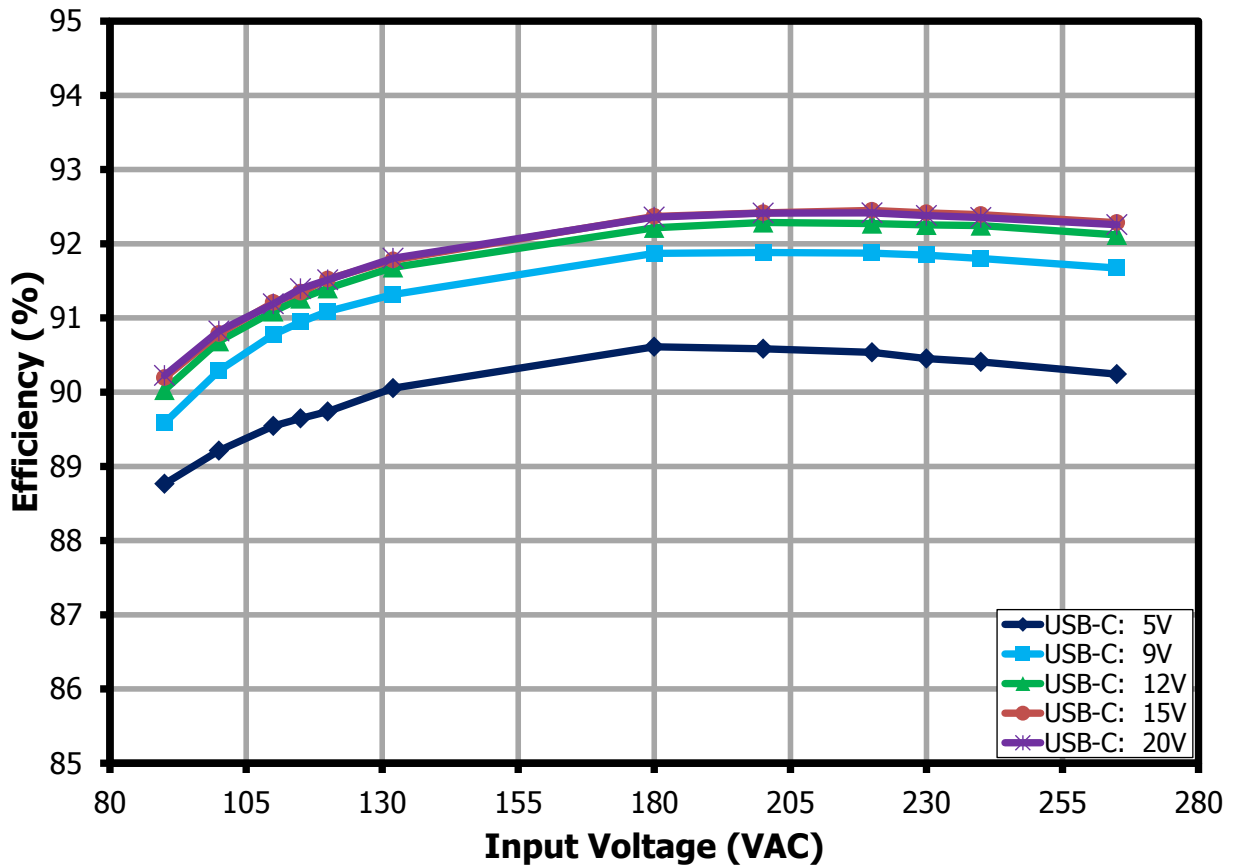

Figure 19 – Flyback Full Load Efficiency vs. Line.



10.3 Average System Efficiency

Note: DOE VI requirements for multiple outputs external PSU: $\geq 0.075 \ln (P_{OUT}) + 0.561$

Note: Output voltages are measured at the end of the PCB where the connectors are located.

USB Type A		USB Type C		Pot (W)	Average Efficiency		Pot	DOE VI Limit (%)
Output (V/A)	P _{OUT} (W)	Output (V/A)	P _{OUT} (W)		115 V	230V		
5 V / 2.4 A	12	20 V / 1.5 A	30	42	87.76	88.25	42	84.13
		15 V / 2 A	30	30	88.90	89.36	42	84.13
		12 V / 2.5 A	30	30	89.38	89.79	42	84.13
		9 V / 3 A	27	27	89.54	89.89	39	83.58
		5 V / 3 A	15	15	88.59	88.64	27	80.82

10.4 System Efficiency vs. Load

Loading Set-up: CC Mode

USB-A Type-A Receptacle: 10 – 100% Load

USB-C Type-C Receptacle: 10 – 100% Load

10.4.1 V_{IN} = 115 VAC 60 Hz

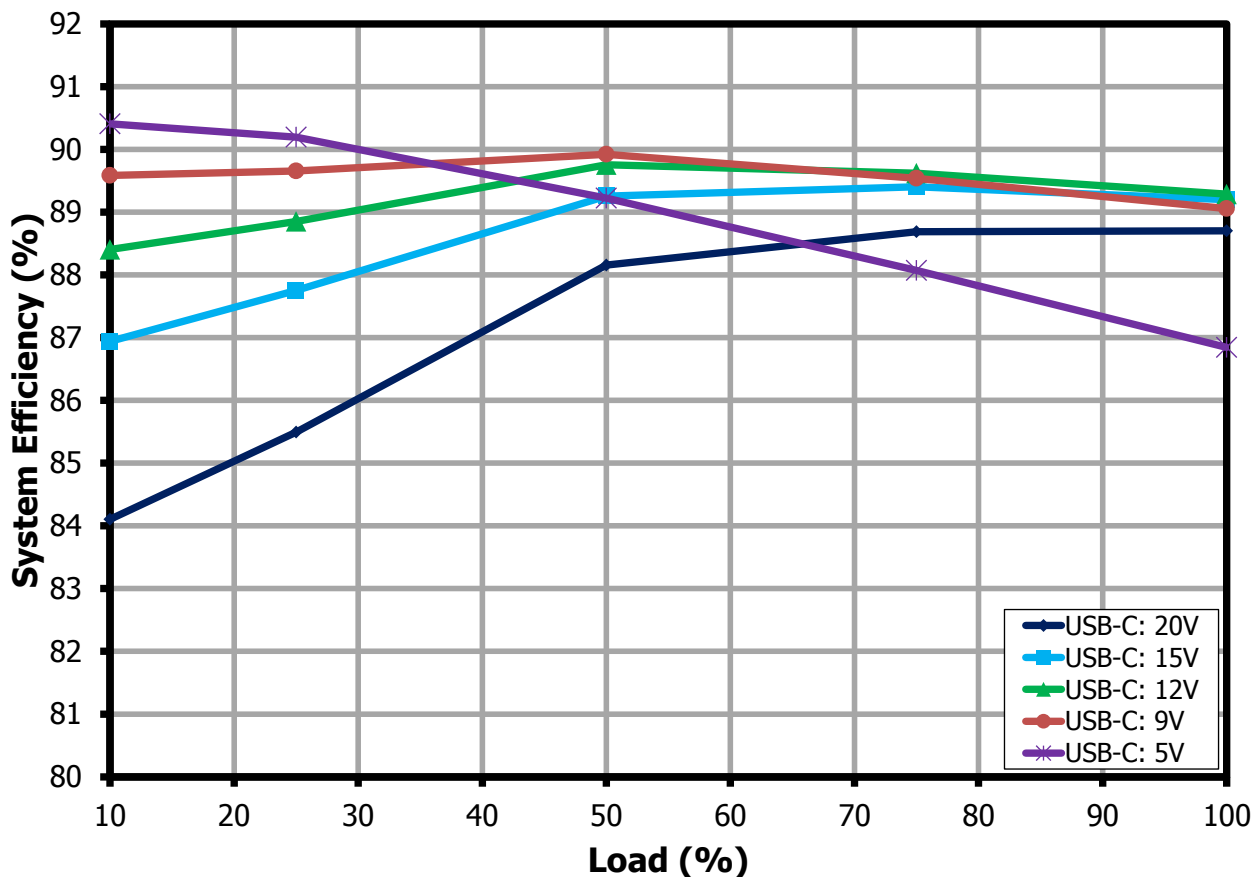

Figure 20 – System Efficiency vs. Load at 115 VAC 60Hz



10.4.2 $V_{IN} = 230 \text{ VAC } 50 \text{ Hz}$

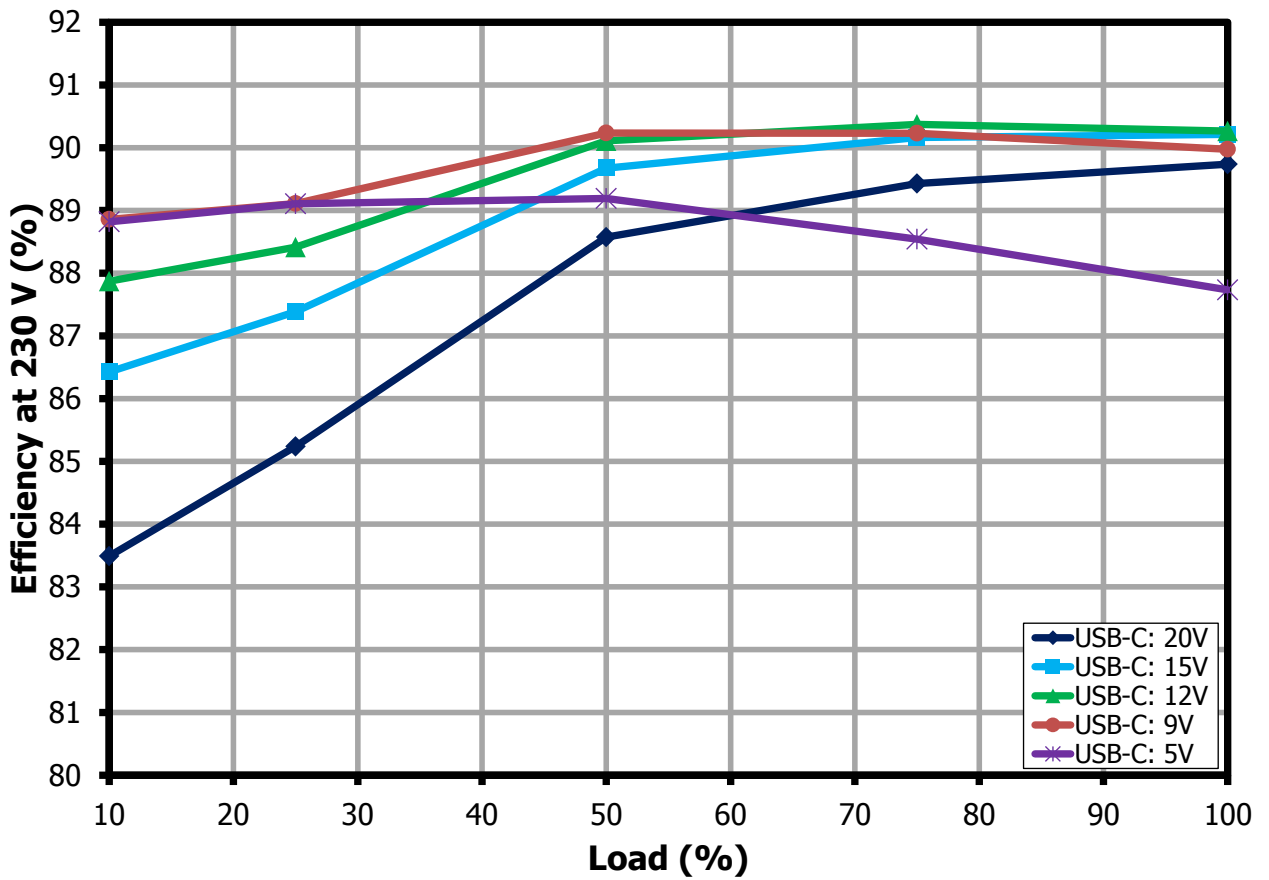

Figure 21 – System Efficiency vs. Load at 230 VAC 50 Hz.



10.5 **No-Load Input Power**

Tested with no USB device connected from the output connectors

Note: DOE VI No Load Mode Limit for multiple output voltage external Power Supply: **≤300 mW**

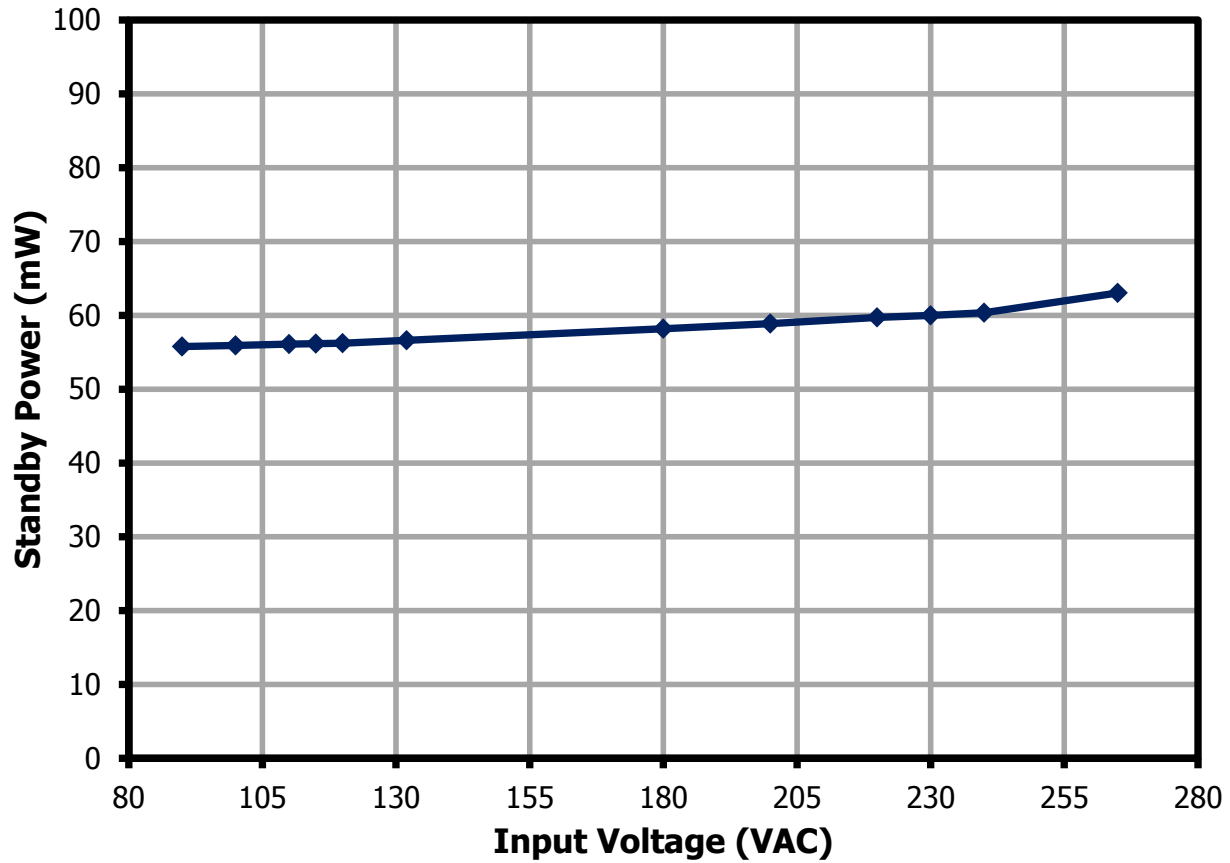

Figure 22 – No-Load Input Power vs. Line.

10.6 Output Voltage Regulation at Full Load

E-load is set at CC Mode Load with the following loading conditions.

Loading Set-up

USB Type A		USB Type C		P _{TOTAL} (W)
Output (V/A)	P _{OUT} (W)	Output (V/A)	P _{OUT} (W)	
5 V / 2.4 A	12	20 V / 1.5 A	30	42
		15 V / 2A	30	42
		12 V / 2.5	30	42
		9 V / 3 A	27	39
		5 V / 3 A	15	27

10.6.1 USB Type-C Receptacle Output Voltage Regulation

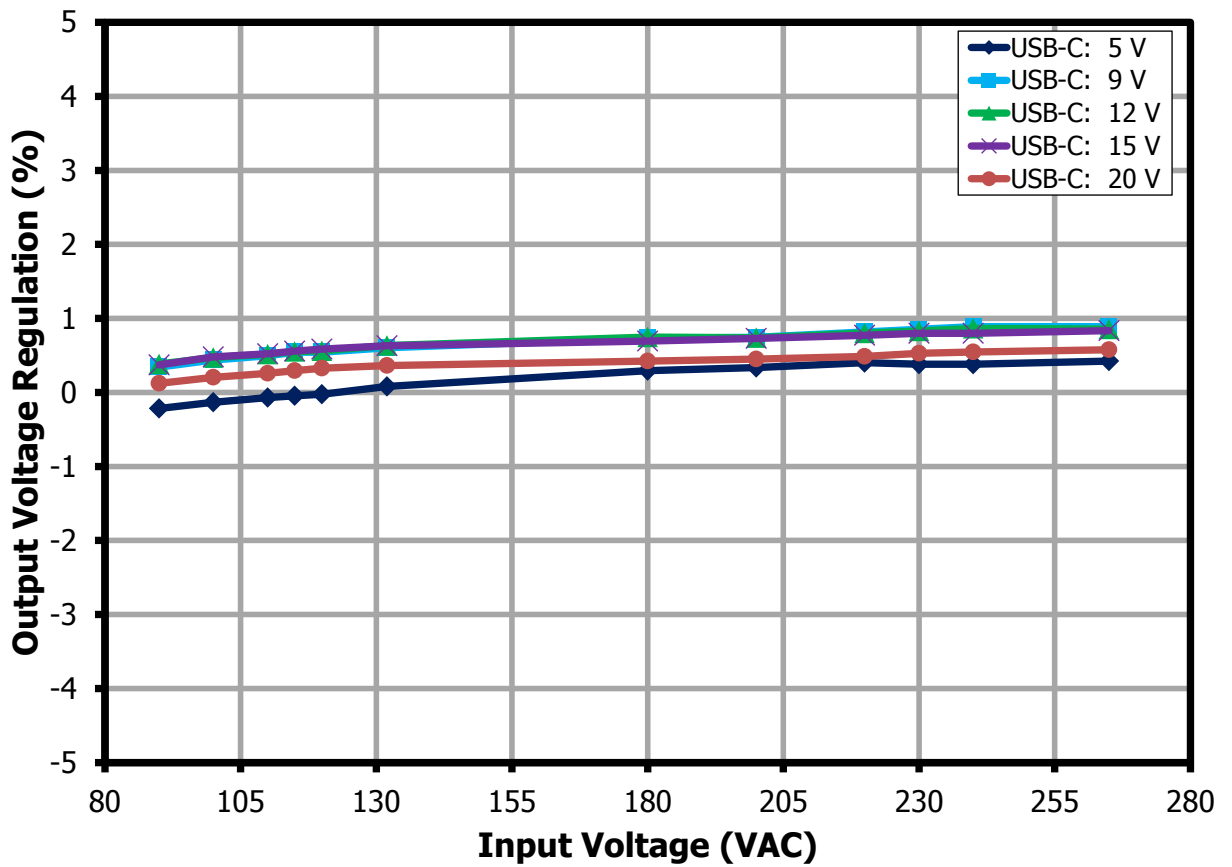

Figure 23 – USB-C Output Voltage Regulation vs. Line.



10.6.2 USB Type-A Receptacle Output Voltage Regulation

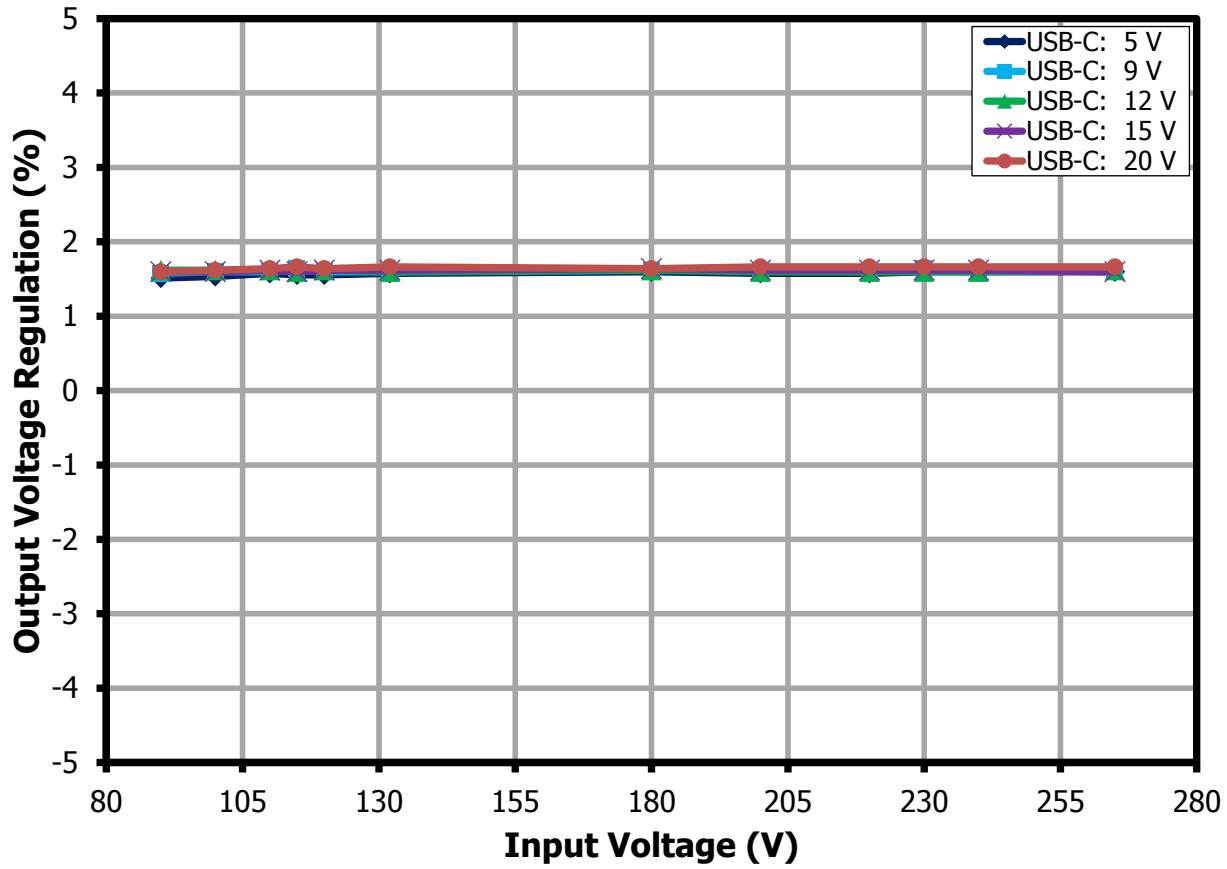

Figure 24 – USB-A Output Voltage Regulation vs. Line.

10.7 **Cross Regulation at $V_{USB-C} = 5 V$**

USB-C and USB-A Voltage regulation was measured at different loading condition from 0% - 100% Load

USB-C % Voltage Regulation = $(V_{USB-C} - 5)/5 \times 100\%$

USB-A % Voltage Regulation = $(V_{USB-A} - 5)/5 \times 100\%$

10.7.1 $V_{IN} = 90 VAC$ 60 Hz

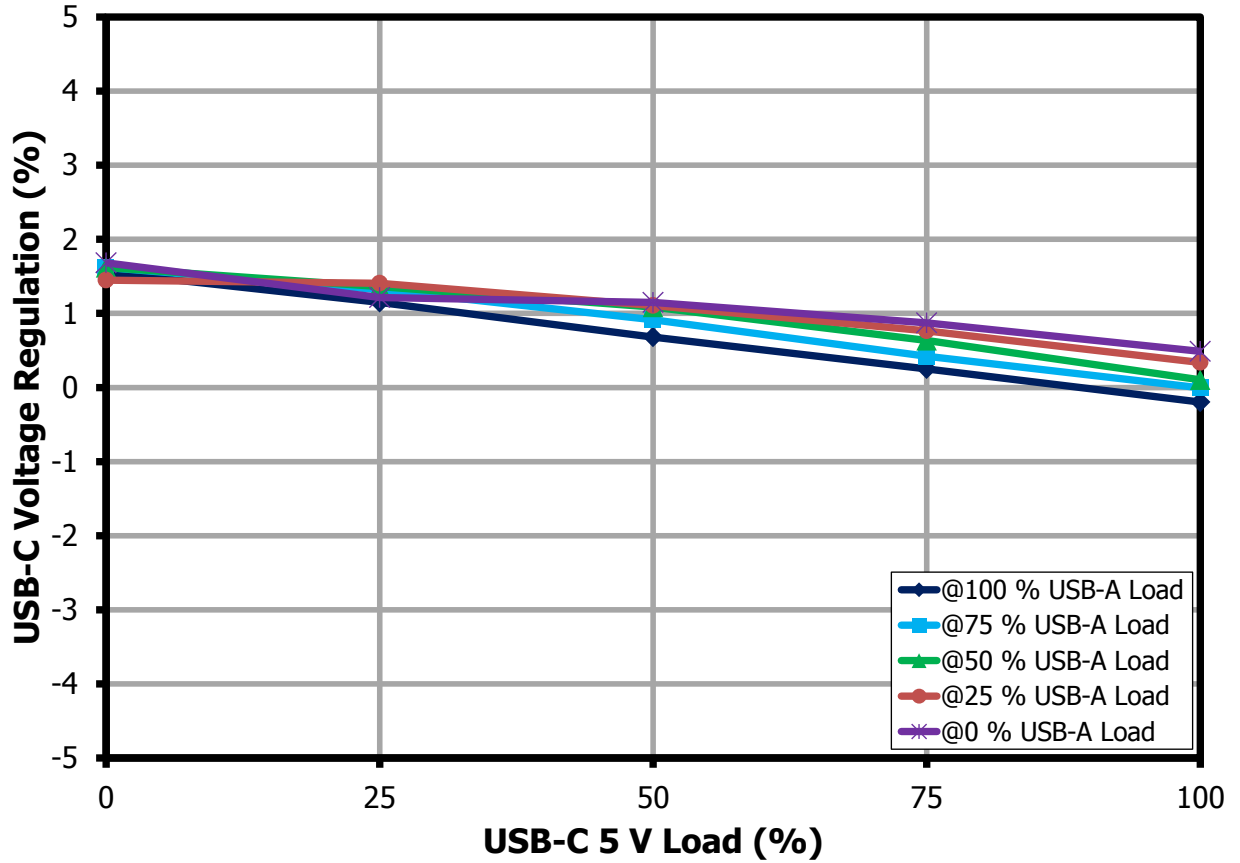

Figure 25 – USB-C Voltage Regulation vs. USB-A / USB-C Load @ 90 VAC.



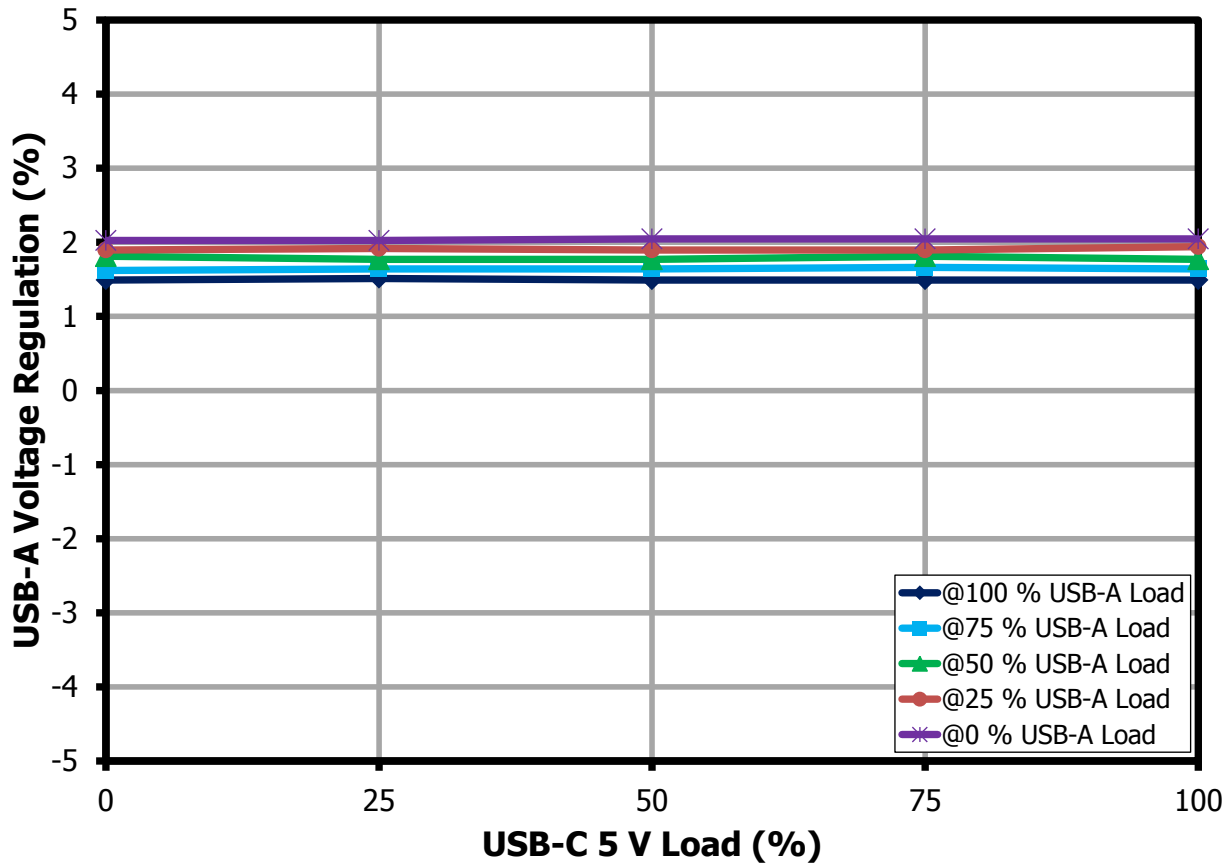

Figure 26 – USB-A Voltage Regulation vs. USB-A / USB-C Load @ 90 VAC.

10.7.2 $V_{IN} = 265 \text{ VAC } 50 \text{ Hz}$

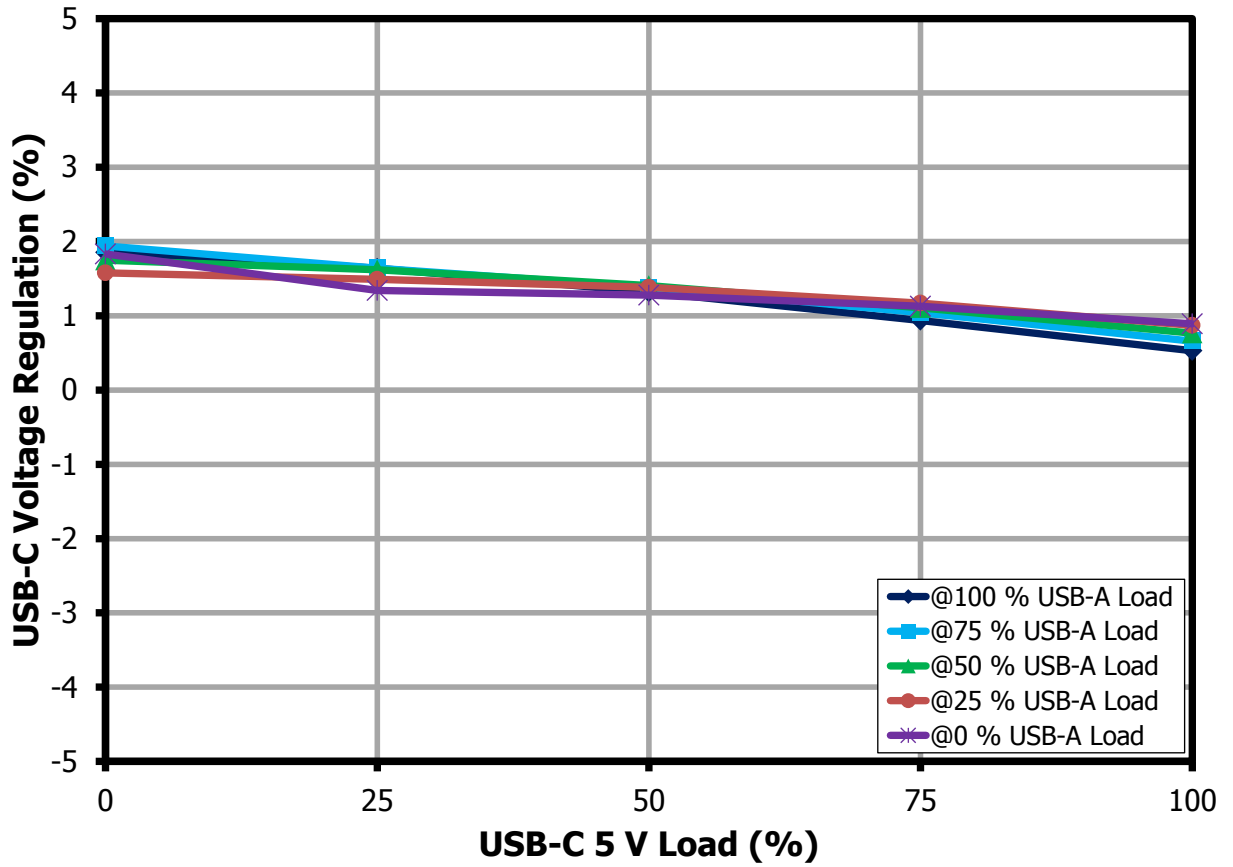

Figure 27 – USB-C Voltage Regulation vs. USB-A / USB-C Load @ 265 VAC.



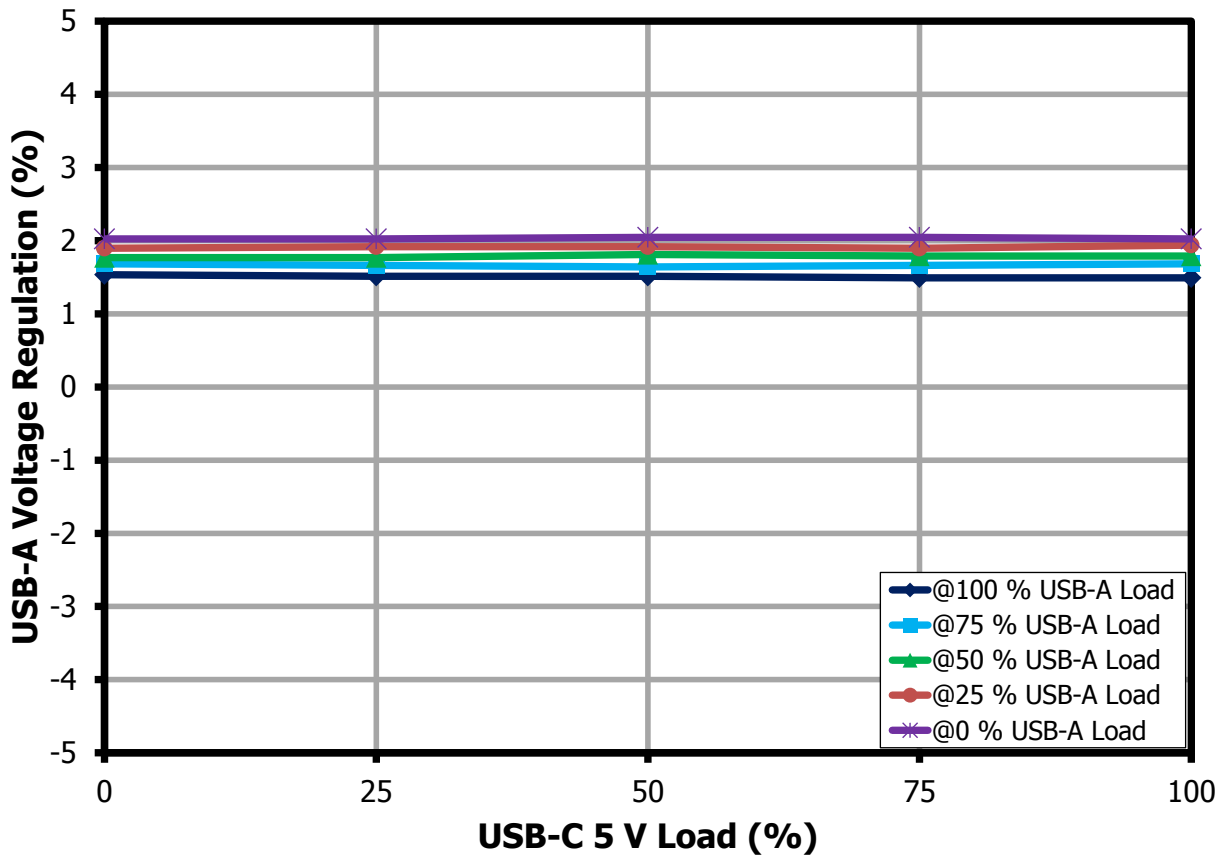

Figure 28 – USB-A Voltage Regulation vs. USB-A / USB-C @ 265 VAC.

10.8 **Cross Regulation at $V_{USB-C} = 20 V$**

USB-C and USB-A Voltage regulation was measured at different loading condition from 0% - 100% Load

USB-C % Voltage Regulation = $(V_{USB-C} - 20)/20 \times 100\%$

USB-A % Voltage Regulation = $(V_{USB-A} - 5)/5 \times 100\%$

10.8.1 $V_{IN} = 90 VAC$

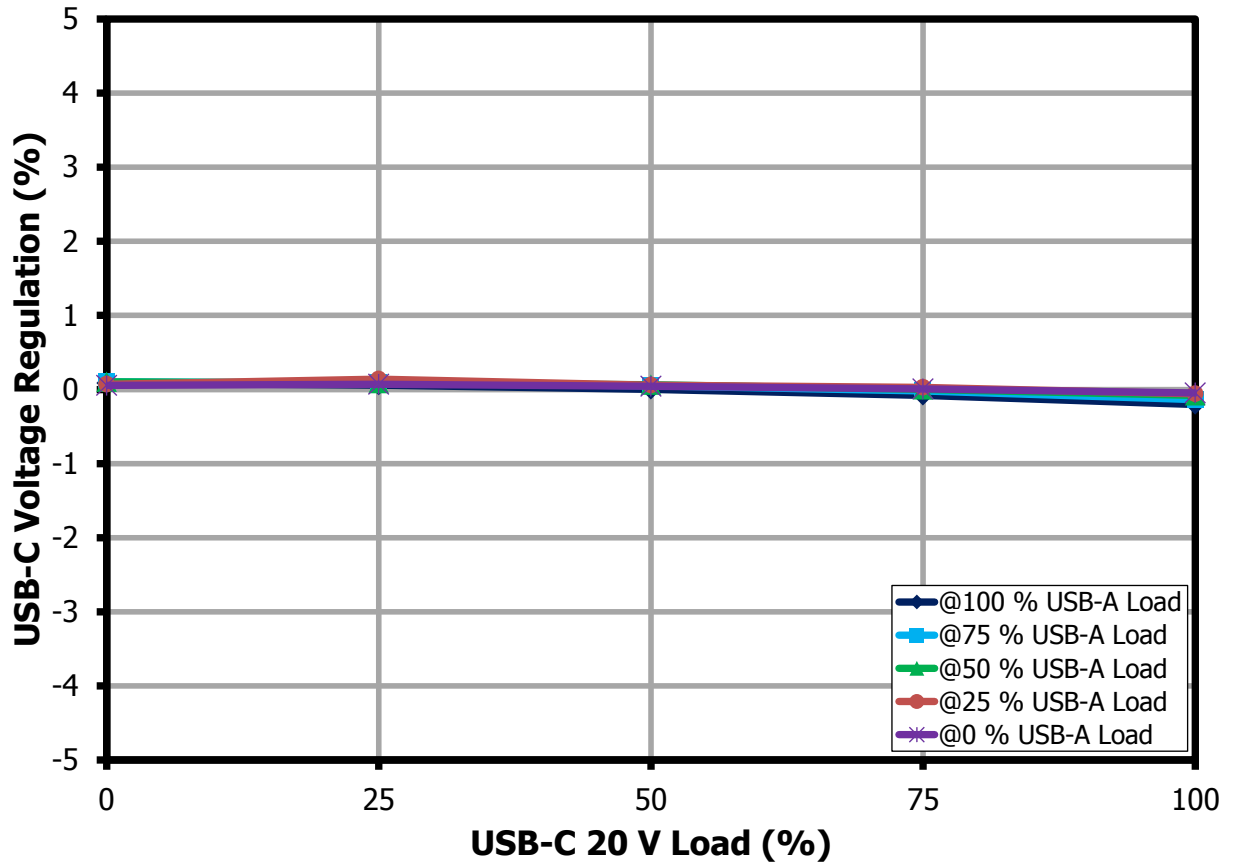

Figure 29 – USB-C Voltage Regulation vs. USB-A / USB-C Load @ 90 VAC.



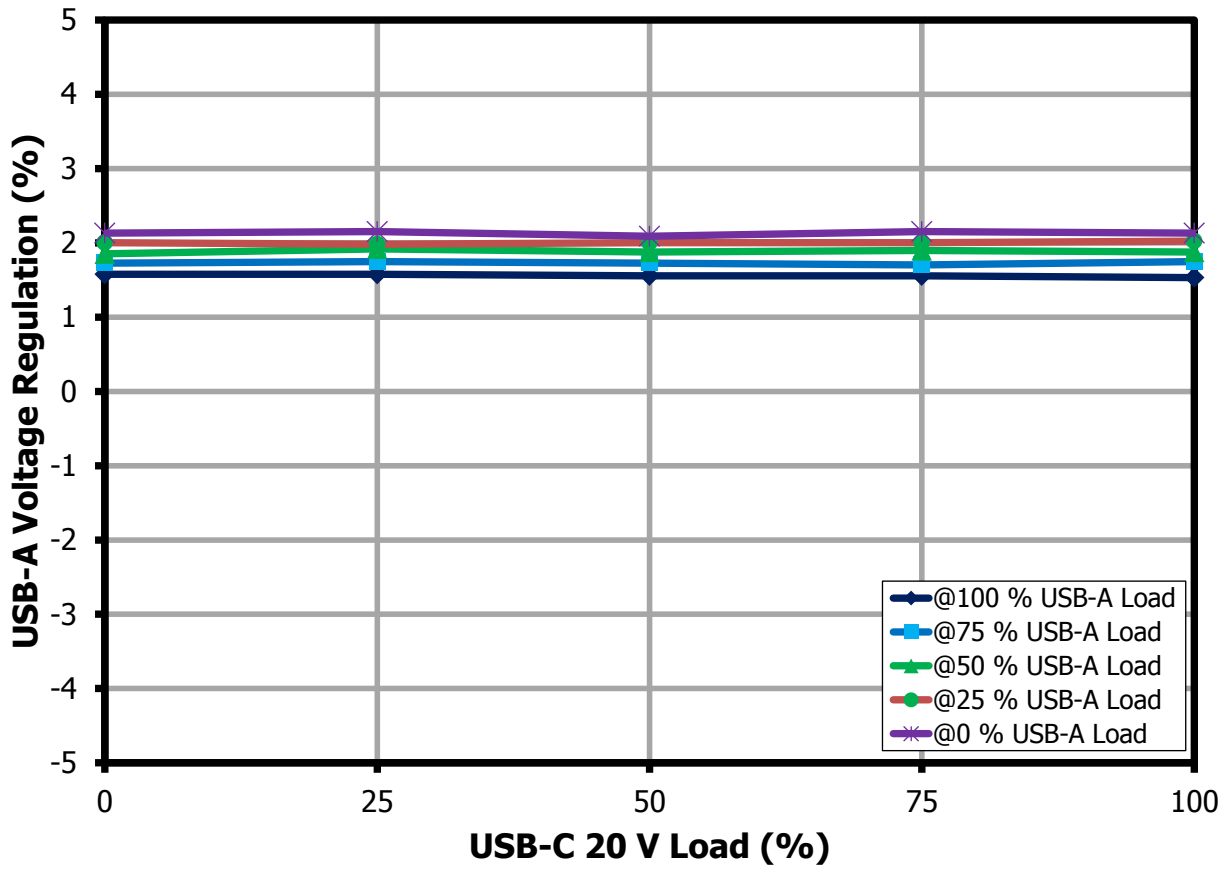

Figure 30 – USB-A Voltage Regulation vs. USB-A / USB-C Load @ 90 VAC.

10.8.2 $V_{IN} = 265 \text{ VAC}$

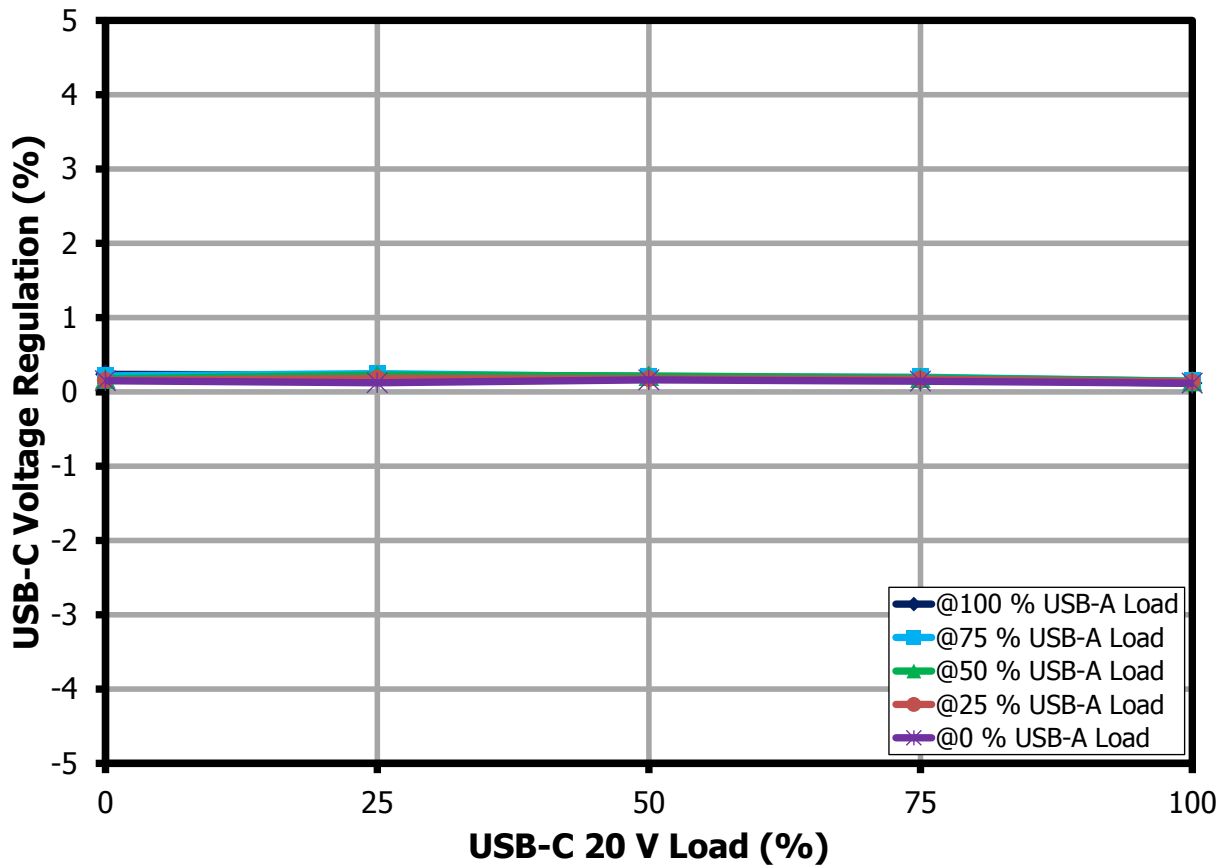

Figure 31 – USB-C Voltage Regulation vs. USB-A / USB-C Load @ 265 VAC.



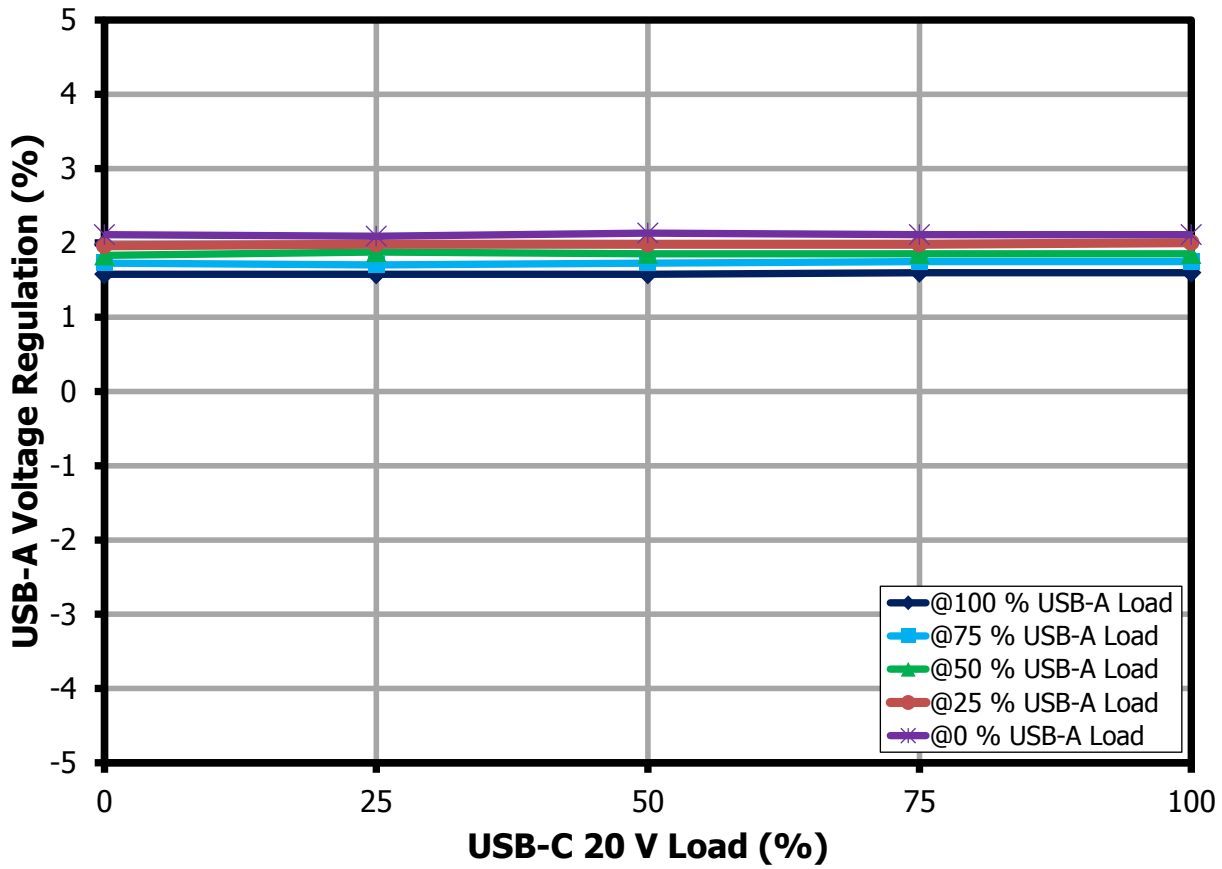

Figure 32 – USB-A Voltage Regulation vs. USB-A / USB-C Load @ 265 VAC.

10.9 ***Output Ripple Voltage***

Set-up: Use x1 voltage probe with 2 capacitors (0.1 μF /50 V ceramic and 47 μF /50 V E-cap) connected across the probe tip and ground as shown below. Oscilloscope was set to AC coupling with frequency bandwidth of 20 MHz. Ripple voltage was measured at the end of 100m Ω output cable at room ambient temperature (25 $^{\circ}\text{C}$).



10.9.1 USB-C Receptacle Output Ripple Voltage

Ripple was tested throughout different USB-C/USB-A loading conditions from 0-100% load.

10.9.1.1 USB-C Ripple Voltage at $V_{USB-C} = 5\text{ V}$

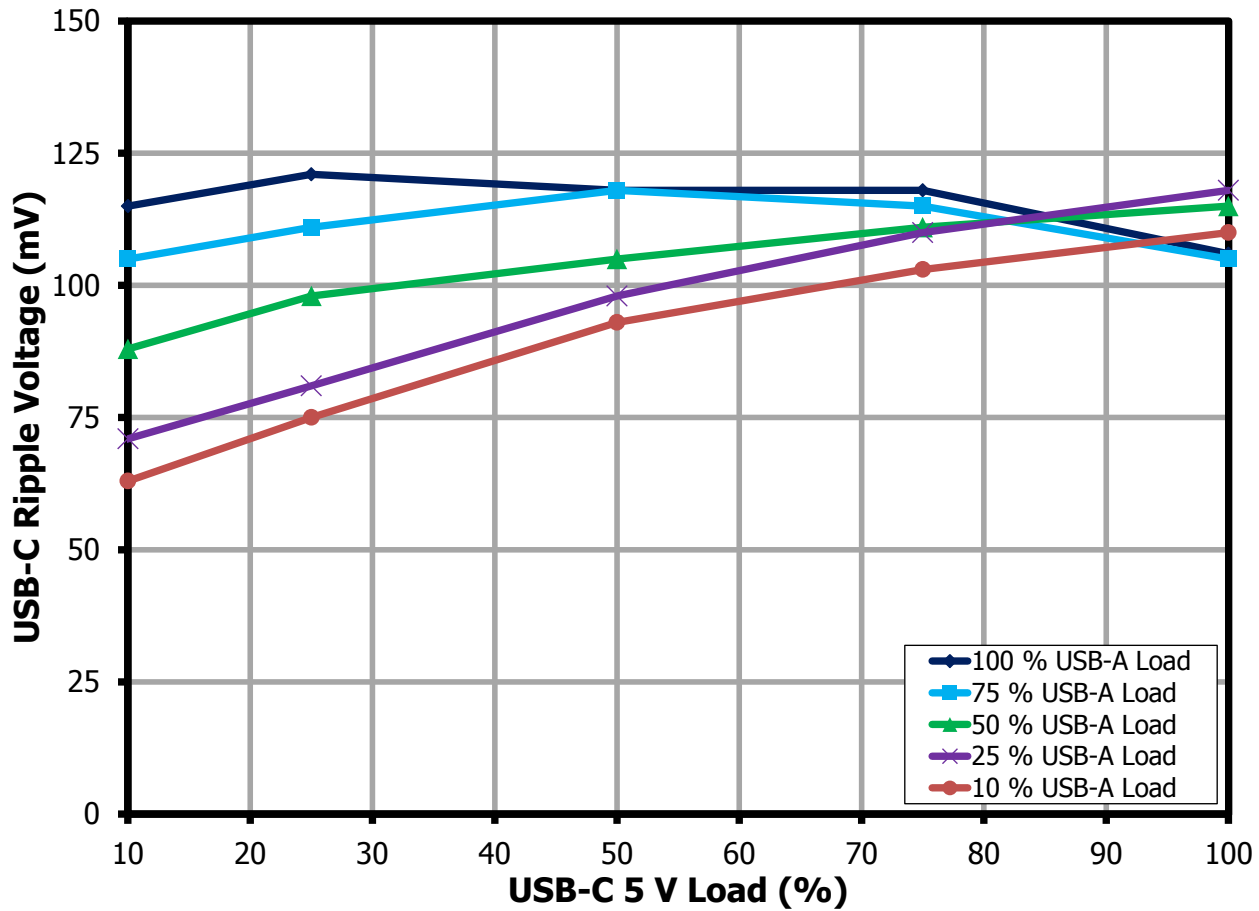

Figure 33 – USB-C Ripple Voltage vs. USB-A / USB-C Load @ 90 VAC.

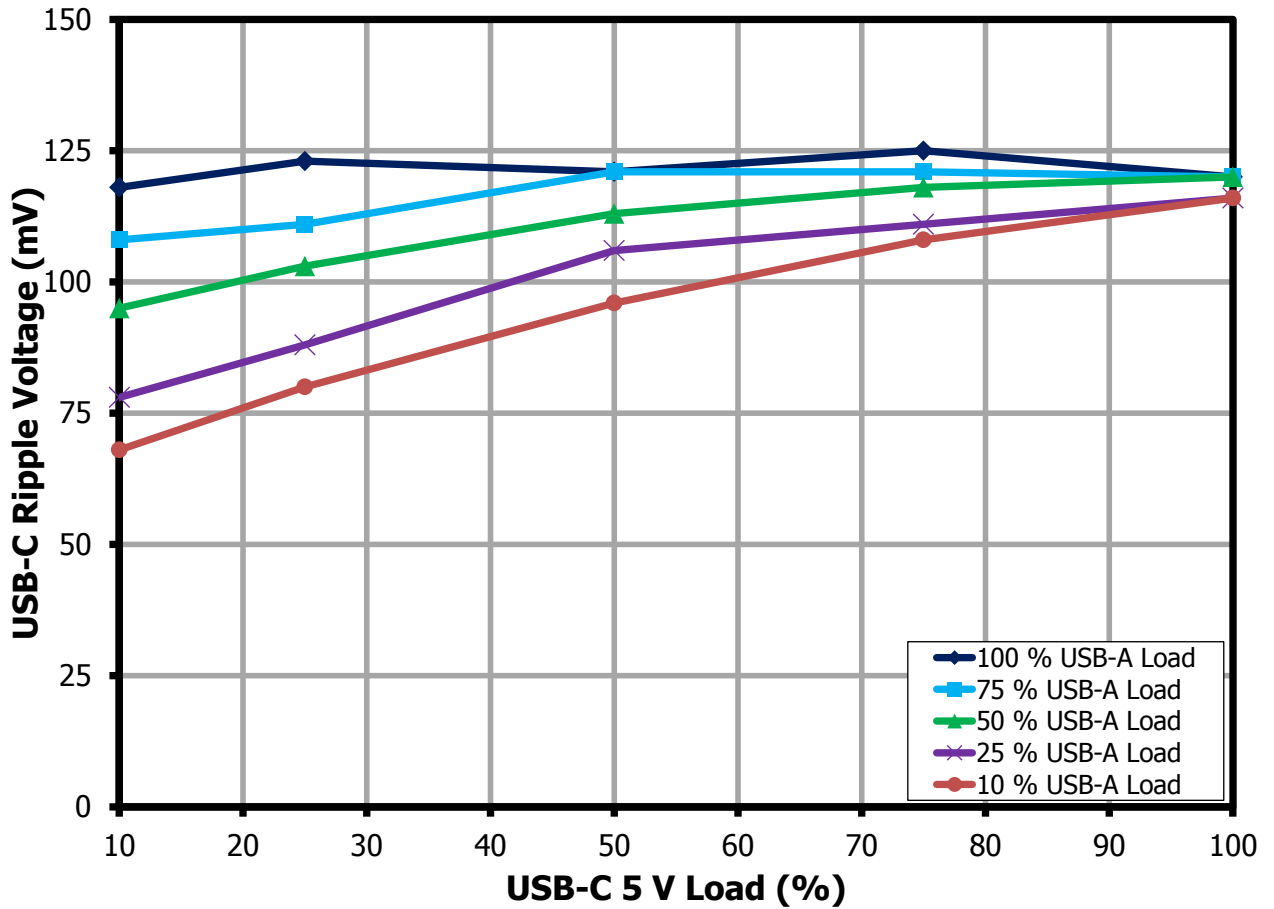

Figure 34 – USB-C Ripple Voltage vs. USB-A / USB-C Load @ 265 VAC.



10.9.1.2 USB-C Ripple Voltage at $V_{USB-C} = 20\text{ V}$

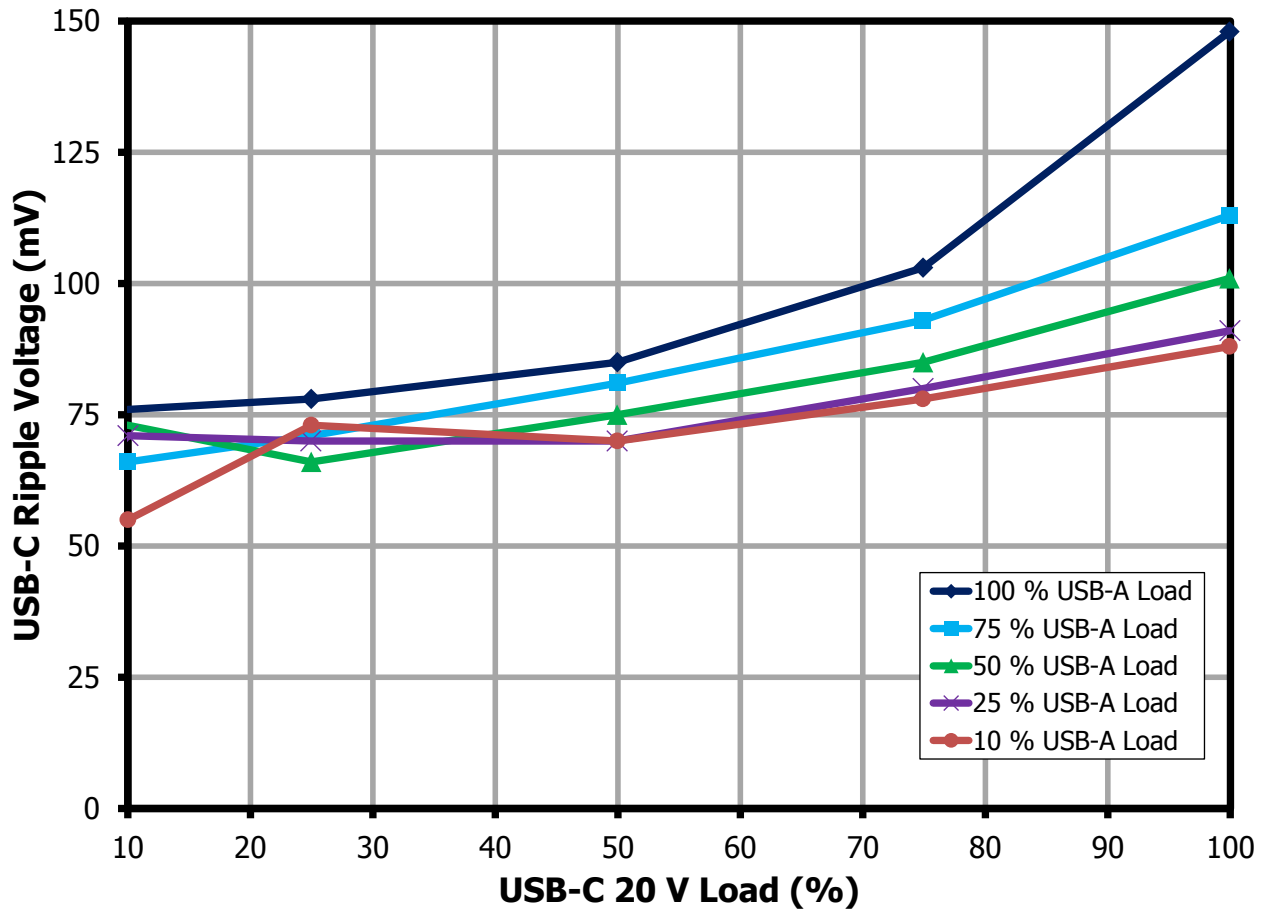

Figure 35 – USB-C Ripple Voltage vs. USB-A / USB-C Load @ 90 VAC.

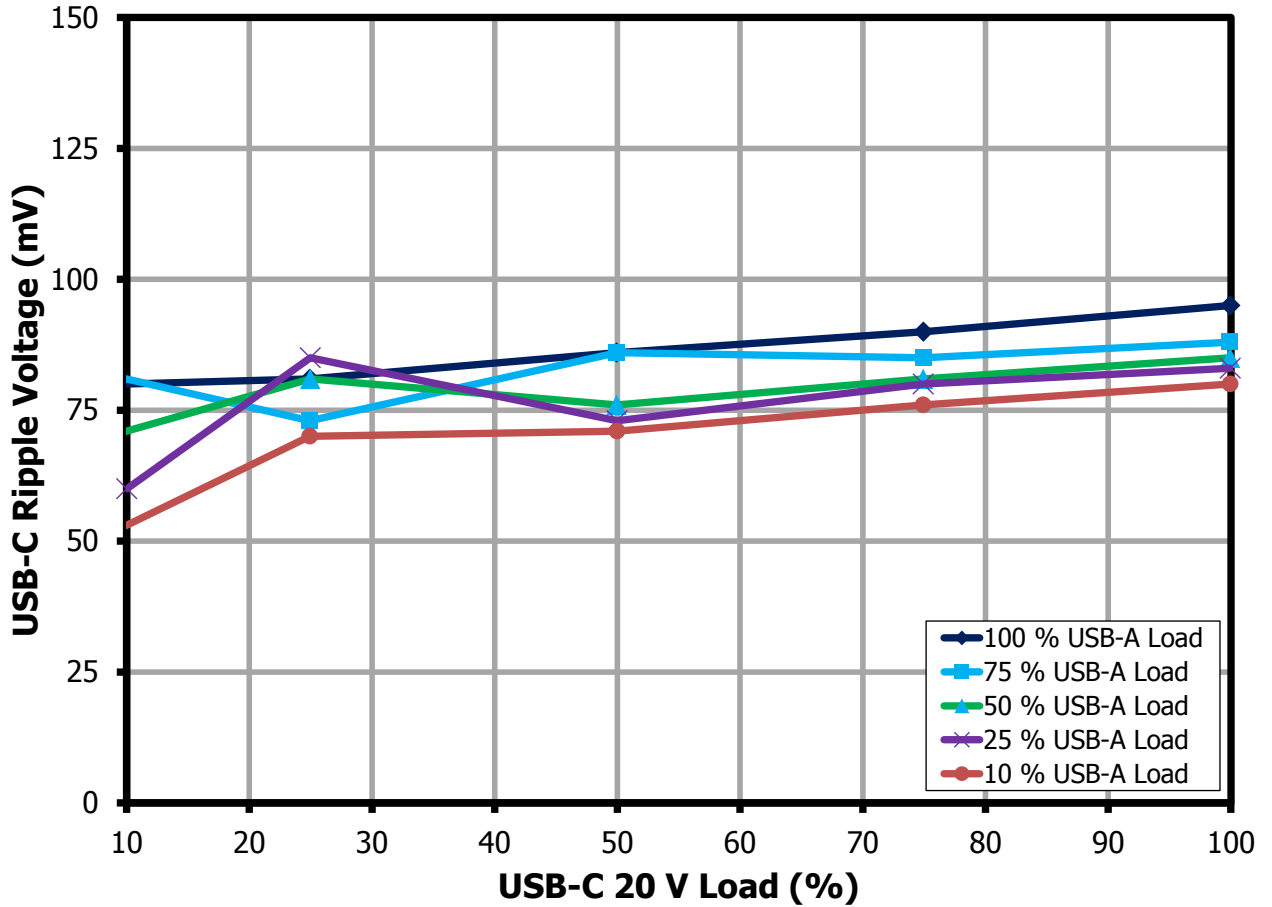

Figure 36 – USB-C Ripple Voltage vs. USB-A / USB-C Load @ 265 VAC.



10.9.2 USB-A Receptacle Ripple Voltage

USB-A ripple voltage was tested throughout different USB-C/USB-A loading conditions from 0-100% load.

10.9.2.1 USB-A Ripple Voltage at $V_{USB-C} = 5\text{ V}$

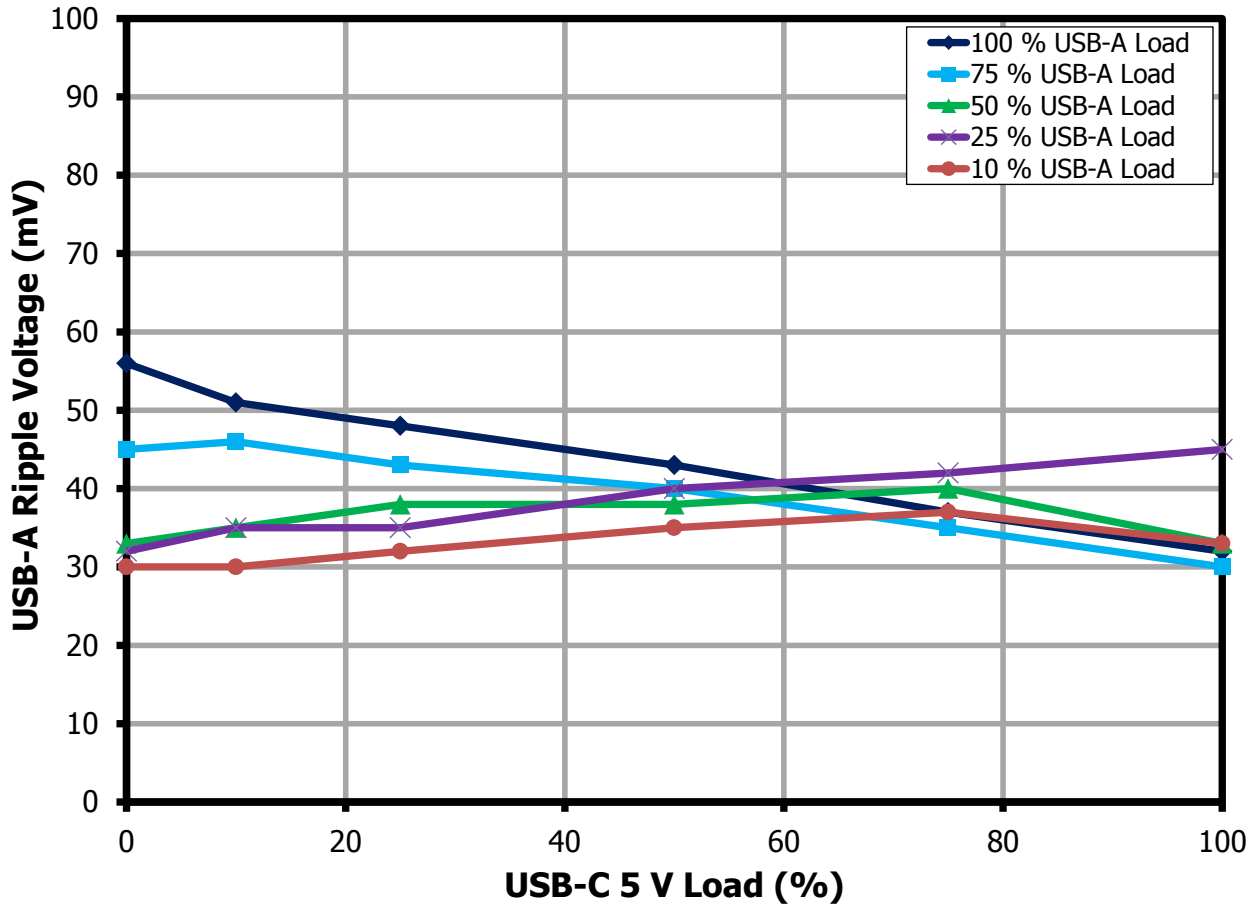

Figure 37 – USB-A Ripple Voltage vs. USB-A / USB-C Load @ 90 VAC.

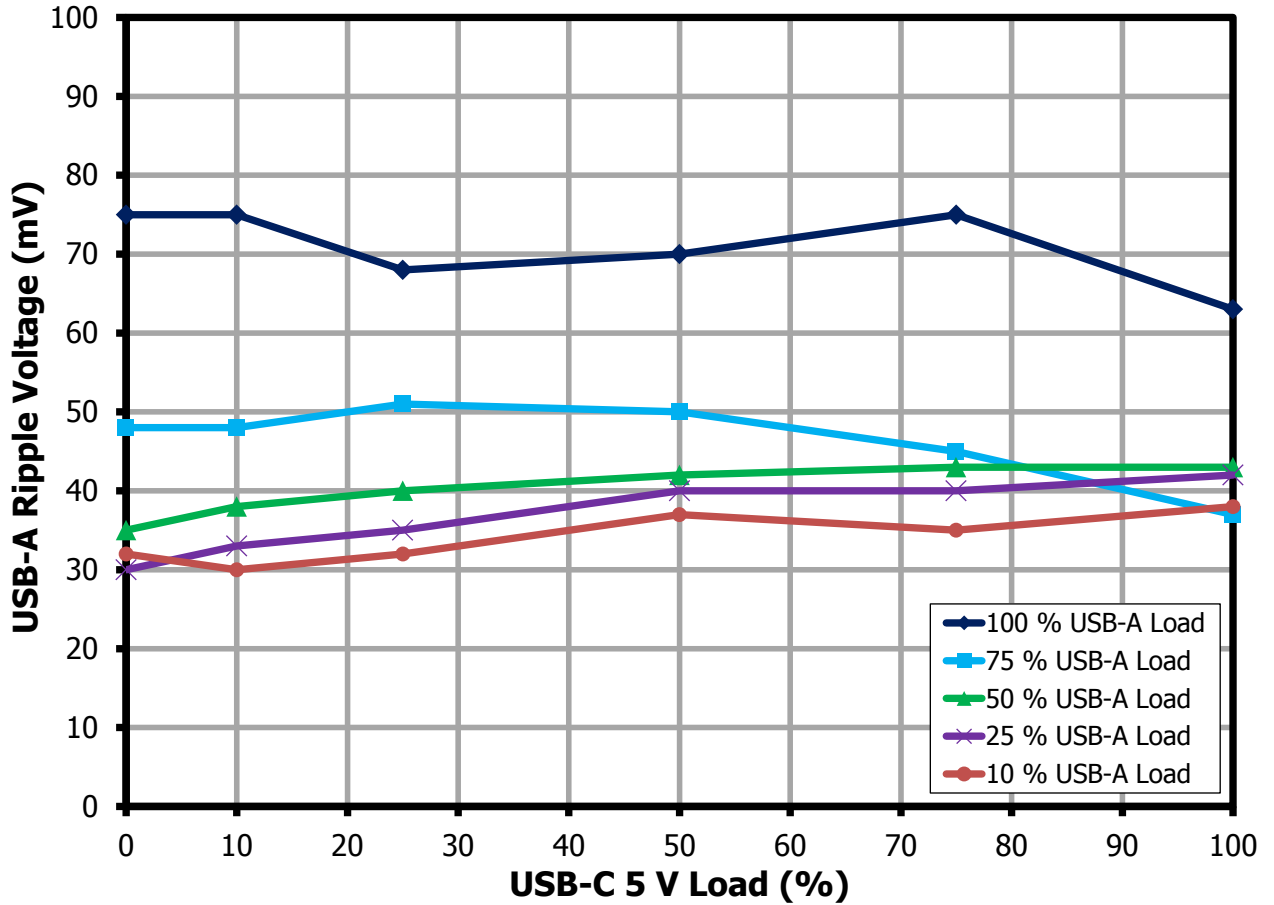

Figure 38 – USB-A Ripple Voltage vs. USB-A / USB-C Load @ 265 VAC.



10.9.2.2 USB-A Ripple Voltage at $V_{USB-C} = 20\text{ V}$

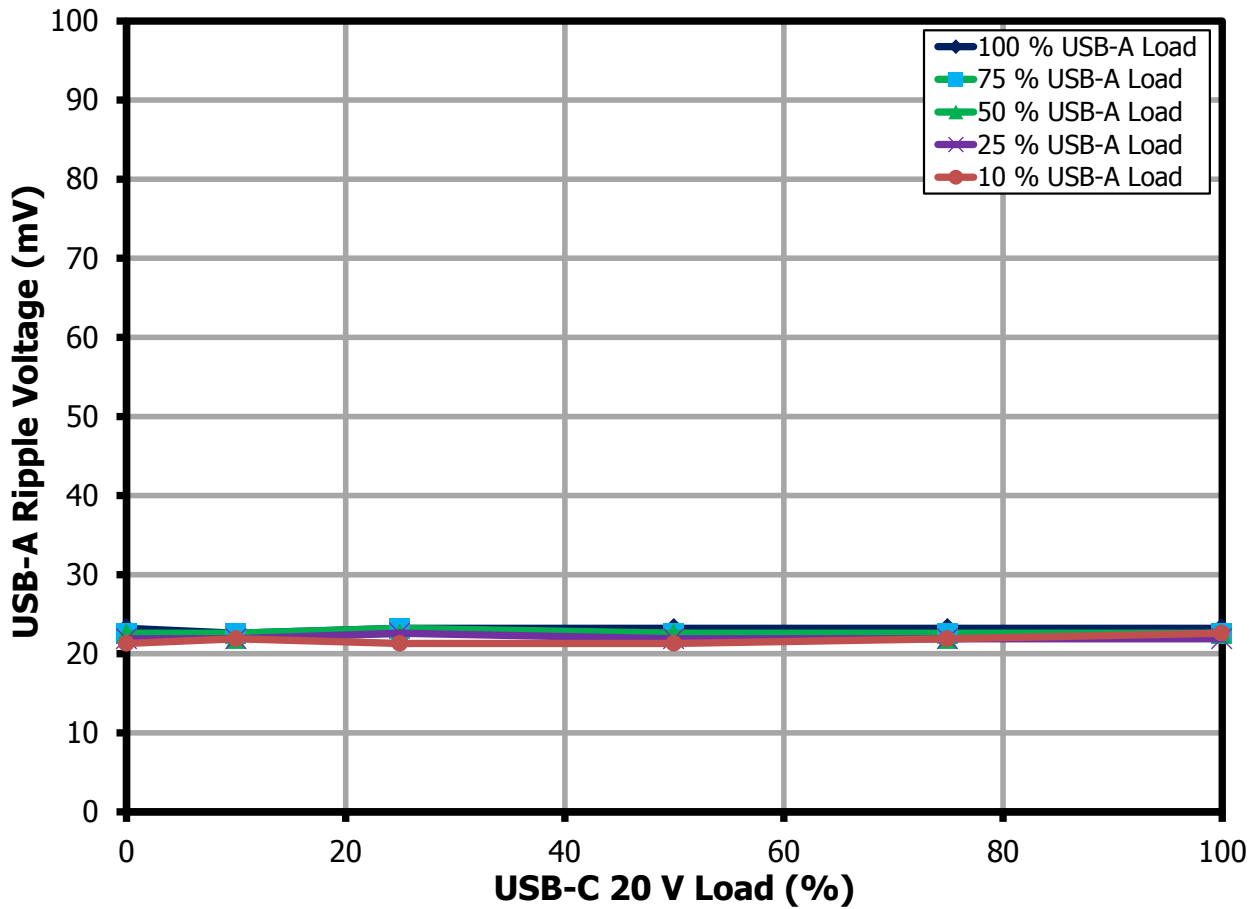

Figure 39 – USB-A Ripple Voltage vs. USB-A / USB-C Load @ 90 VAC.

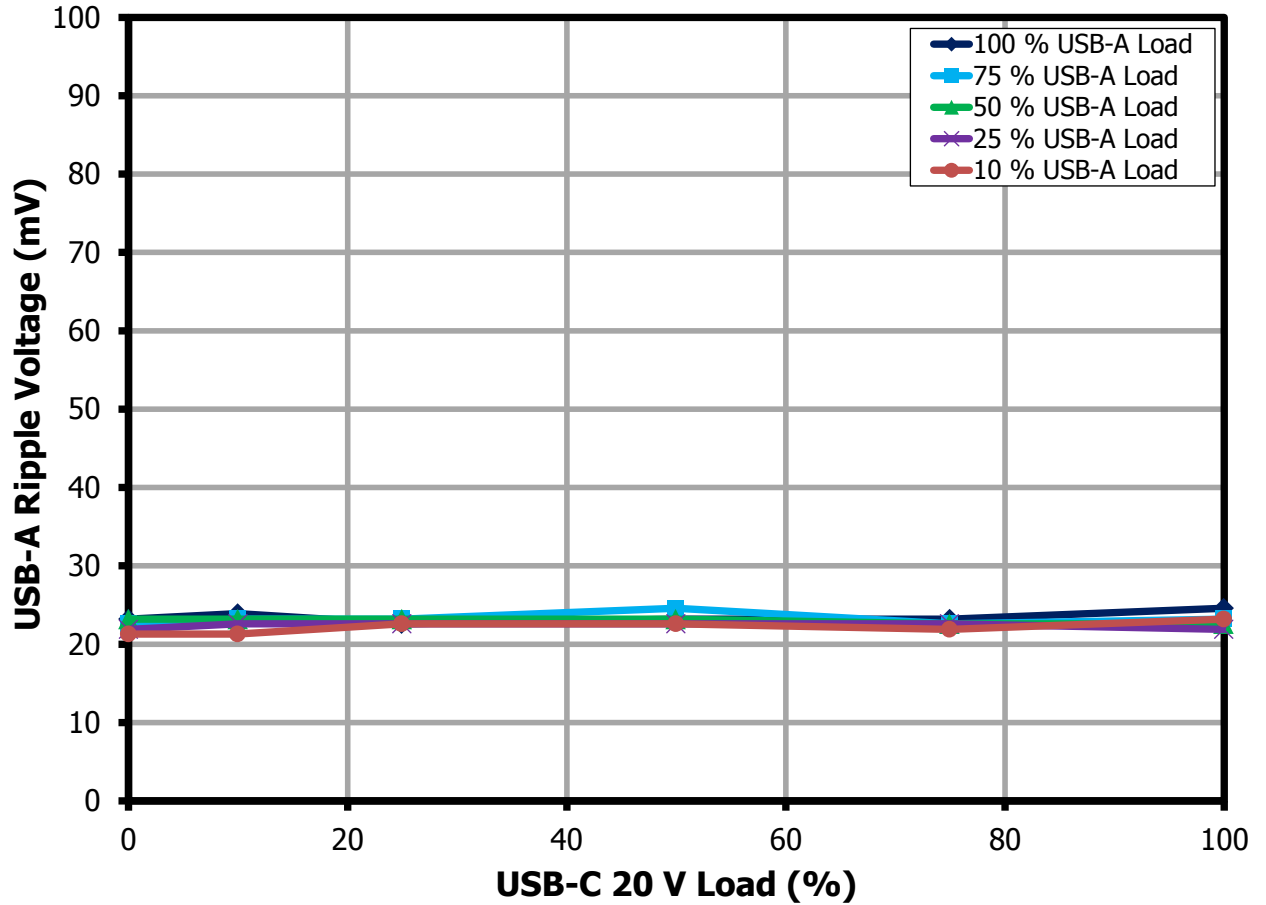

Figure 40 – USB-A Ripple Voltage vs. USB-A / USB-C Load @ 265 VAC.



10.10 *Transient Load Response Test Data*

10.10.1 USB Type-C Transient Load Response at $V_{USB-C} = 20\text{ V}$

Note: USB-C transient load was tested with USB-A receptacle at full load condition. Output Voltage was measured at the end of 60 m Ω output cable.

USB-C Transient Load at USB-C 20 V	Input		Overshoot/Undershoot Measurement			
	Vin (V)	Freq (Hz)	USB-C Vomax (V)	USB-C Vomin (V)	USB-A Vomax (V)	USB-A Vomin (V)
0-100%	0-100% USB-C Dynamic Load $V_{USB-C} = 20\text{ V} / 0 -1.5\text{ A}$, $V_{USB-A} = 5\text{ V} / 2.4\text{ A}$					
	90	60	20.19	19.69	5.18	5.03
	115	60	20.22	19.70	5.18	5.01
	230	50	20.22	19.72	5.18	5.03
	265	60	20.22	19.74	5.18	5.03
50-100%	50-100% USB-C Dynamic Load $V_{USB-C} = 20\text{ V} / 0.75-1.5\text{ A}$, $V_{USB-A} = 5\text{ V} / 2.4\text{ A}$					
	90	60	20.20	19.74	5.16	5.03
	115	60	20.19	19.74	5.16	5.01
	230	50	20.20	19.75	5.16	5.01
	265	60	20.22	19.75	5.18	5.03

10.10.2 USB Type-C Transient Load Response at $V_{USB-C} = 5\text{ V}$

Note: USB-C transient load was tested with USB-A receptacle at full load condition. Output Voltage was measured at the end of 60 m Ω output cable.

USB-C Transient Load at USB-C 5 V	Input		Overshoot/Undershoot Measurement			
	Vin (V)	Freq (Hz)	USB-C Vomax (V)	USB-C Vomin (V)	USB-A Vomax (V)	USB-A Vomin (V)
0-100%	0-100% USB-C Dynamic Load $V_{USB-C} = 5\text{ V} / 0-3\text{ A}$, $V_{USB-A} = 5\text{ V} / 2.4\text{ A}$					
	90	60	5.13	4.76	5.23	4.95
	115	60	5.15	4.77	5.23	4.95
	230	50	5.15	4.77	5.23	4.95
	265	60	5.15	4.79	5.23	4.95
50-100%	50-100% USB-C Dynamic Load $V_{USB-C} = 5\text{ V} / 1.5-3\text{ A}$, $V_{USB-A} = 5\text{ V} / 2.4\text{ A}$					
	90	60	5.11	4.81	5.21	4.95
	115	60	5.12	4.83	5.21	4.95
	230	50	5.13	4.83	5.21	4.95
	265	60	5.13	4.84	5.21	4.95

10.10.3 USB Type-A Transient Load Response at $V_{USB-C} = 20\text{ V}$

Note: USB-A transient load was tested with USB-C receptacle at full load condition. Output Voltage was measured at the end of 60 m Ω output cable.

USB-A Transient Load At USB-C 20 V	Input		Overshoot/Undershoot Measurement			
	Vin (V)	Freq (Hz)	USB-A Vomax (V)	USB-A Vomin (V)	USB-C Vomax (V)	USB-C Vomin (V)
0-100%	0-100% USB-A Dynamic Load $V_{USB-C} = 5\text{ V} / 3\text{ A}$, $V_{USB-A} = 5\text{ V} / 0-2.4\text{ A}$					
	90	60	20.16	19.73	5.63	4.59
	115	60	20.19	19.76	5.63	4.59
	230	50	20.19	19.76	5.65	4.59
	265	60	20.19	19.78	5.65	4.59
50-100%	50-100% USB-A Dynamic Load $V_{USB-C} = 5\text{ V} / 3\text{ A}$, $V_{USB-A} = 5\text{ V} / 1.2-2.4\text{ A}$					
	90	60	20.18	19.74	5.33	4.84
	115	60	20.19	19.76	5.33	4.84
	230	50	20.19	19.78	5.35	4.84
	265	60	20.21	19.79	5.35	4.84

10.10.4 USB Type-A Transient Load Response at $V_{USB-C} = 20\text{ V}$

Note: USB-A transient load was tested with USB-C receptacle at full load condition. Output Voltage was measured at the end of 60 m Ω output cable.

USB-A Transient Load At USB-C 5 V	Input		Overshoot/Undershoot Measurement			
	Vin (V)	Freq (Hz)	USB-A Vomax (V)	USB-A Vomin (V)	USB-C Vomax (V)	USB-C Vomin (V)
0-100%	0-100% USB-A Dynamic Load $V_{USB-C} = 5\text{ V} / 3\text{ A}$, $V_{USB-A} = 5\text{ V} / 0-2.4\text{ A}$					
	90	60	5.12	4.81	5.54	4.55
	115	60	5.12	4.81	5.53	4.55
	230	50	5.14	4.82	5.53	4.56
	265	60	5.15	4.82	5.53	4.56
50-100%	50-100% USB-A Dynamic Load $V_{USB-C} = 5\text{ V} / 3\text{ A}$, $V_{USB-A} = 5\text{ V} / 1.2-2.4\text{ A}$					
	90	60	5.1	4.79	5.39	4.75
	115	60	5.1	4.82	5.39	4.75
	230	50	5.14	4.84	5.39	4.75
	265	60	5.14	4.82	5.39	4.73

10.11 **Overcurrent Protection**

OCP threshold was tested using E-load set at CC mode loading. Output current is increase slowly until it reaches the OCP level.

Input Voltage	USB Type C OCP Threshold (mA)				
	USB-C 5 V	USB-C 9 V	USB-C 12 V	USB-C 15 V	USB-C 20 V
90 V 60 Hz	2919.60	2899.92	2920.11	4224.97	5125.91
265 V 50 Hz	2919.51	2919.74	2939.56	3804.23	5124.78

Input Voltage	USB Type C OCP Threshold (mA)				
	USB-C 5 V	USB-C 9 V	USB-C 12 V	USB-C 15 V	USB-C 20 V
90 V 60 Hz	3460.16	3460.16	2880.10	2299.85	1699.74
265 V 50 Hz	3459.78	3440.33	2880.10	2299.66	1719.61

11 Thermal Performance

11.1 Thermal Scan at 25 °C Ambient

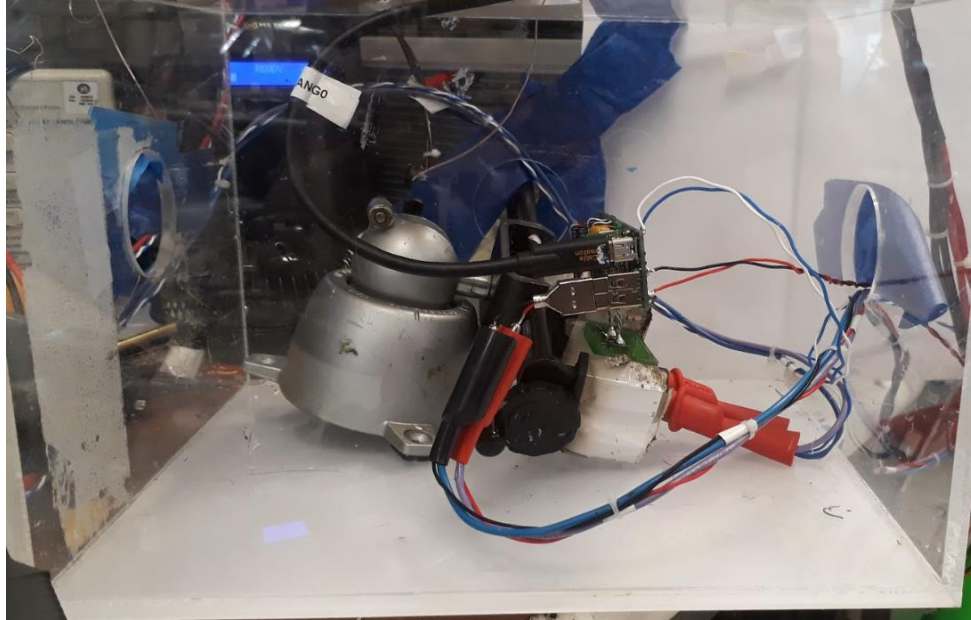

Figure 41 – Test Set-up Picture.

11.2 Thermal Scan Summary

Components	Thermal Scan Data(°C)									
	USB-C:20 V		USB-C:15 V		USB-C:12 V		USB-C:9 V		USB-C:5 V	
	90V	265 V	90V	265 V	90V	265 V	90V	265 V	90V	265 V
InnoSwitch3-Pro (U1)	89.3	90.6	85.4	89.3	87.7	86.1	86.8	87.6	74.6	76.8
SRFET(Q2)	81.3	81.6	81.2	84.3	86	80.1	88.5	90.5	88.2	88.5
Power Transformer (T1)	89	90.6	86.5	89.9	88.7	91	88.3	90	80.2	82
Primary Snubber Diode (D1)	90.4	87.6	86.2	85.7	87.3	80.2	85.6	83.2	73.1	72.1
Bridge Diode (BR1)	95	66.7	92.4	66.7	93.5	61.9	89.7	64.3	72.5	82.9
Input CMC (L2)	91.8	54.5	90.1	55.4	90.9	53.8	84.6	62.5	64.4	44.4
Buck-Boost Controller IC (U4)	94.3	94	85.4	87.7	85.2	85.5	83.6	83.6	86.1	85.4
Buck-Boost Inductor (L3)	90.1	90.1	83.1	84.4	81	81.6	78.5	81	79.3	80.8

11.2.1 90 VAC Input USB-C: 20 V / 1.5 A, USB-A: 5 V / 2.4 A

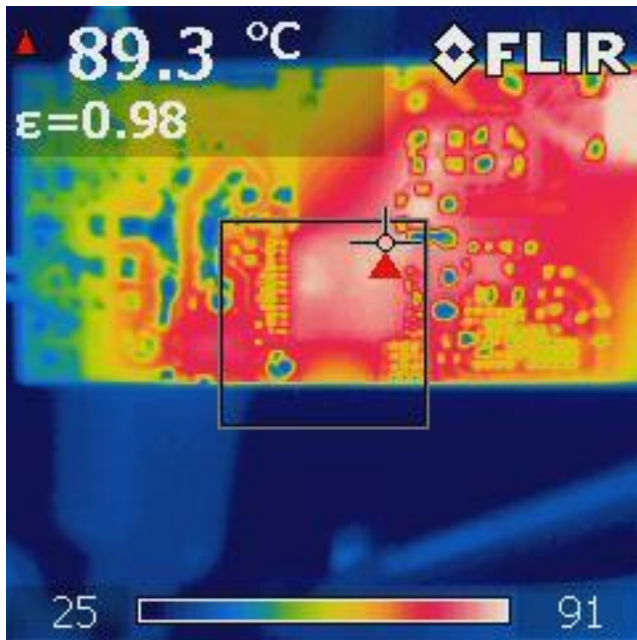

Figure 42 – InnoSwitch3-Pro: 89.3 °C.

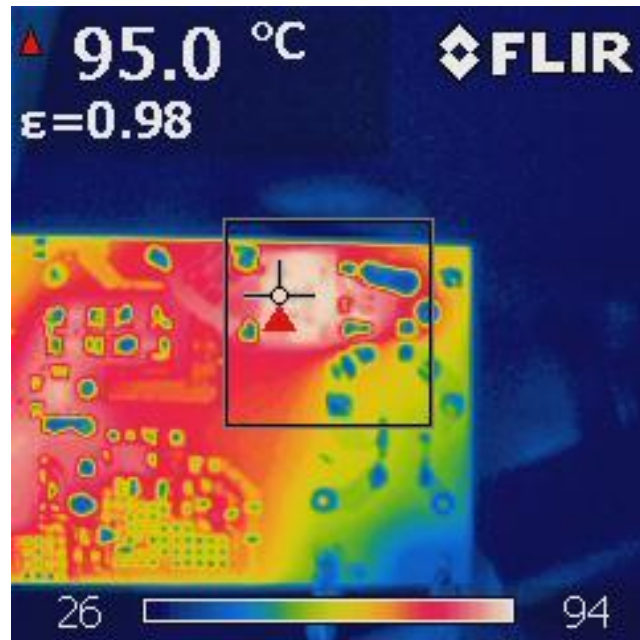

Figure 43 – Bridge Diode (BR1): 95 °C.

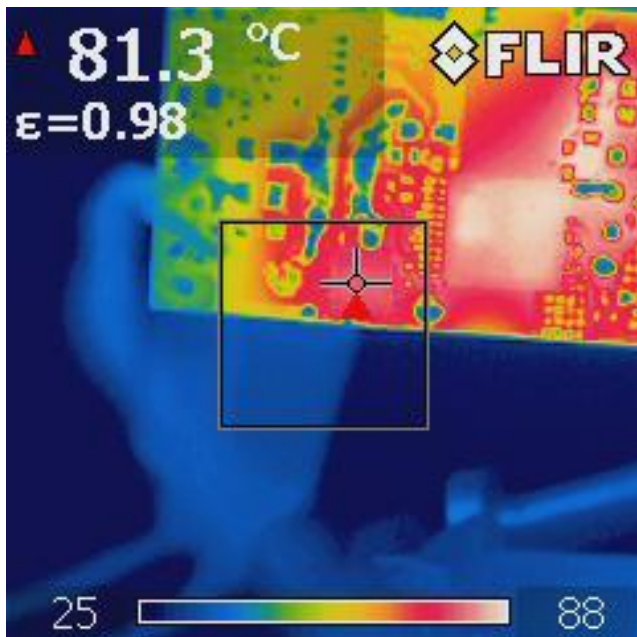

Figure 44 – SRFET (Q2): 89.3 °C.

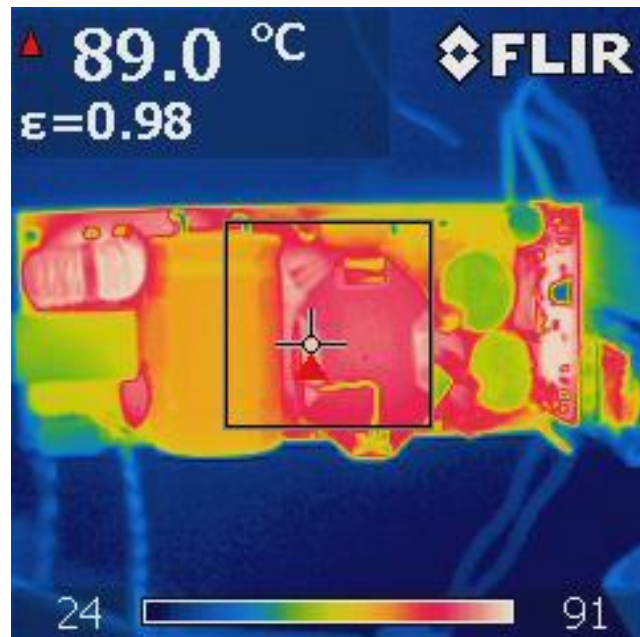

Figure 45 – Transformer (T1): 89 °C.

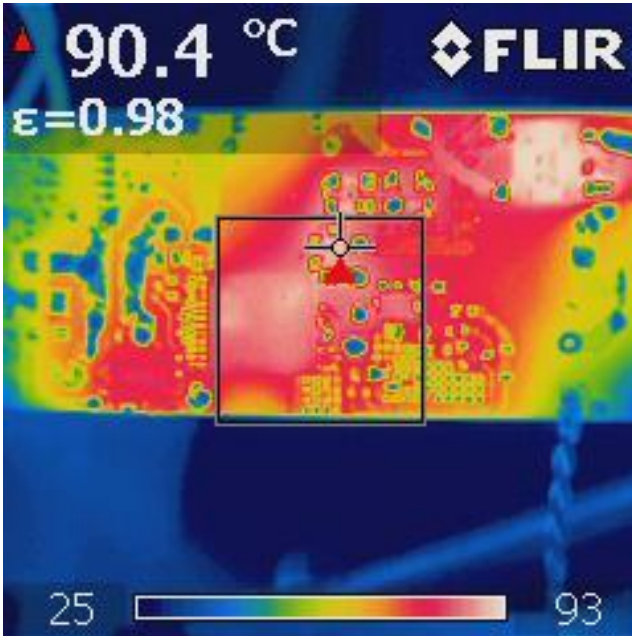

Figure 46 – Snubber Diode (D1): 90.4 °C.

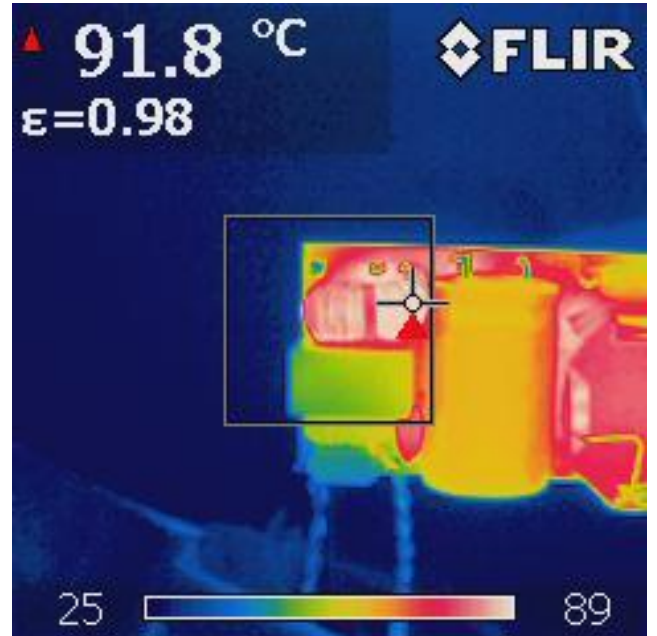

Figure 47 – Input CMC (L2): 91.8 °C.

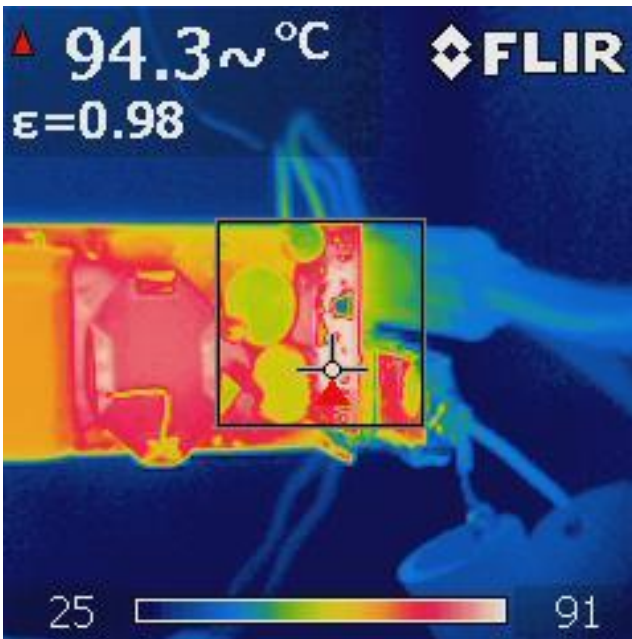

Figure 48 – Buck-Boost IC (U4): 89.3 °C.

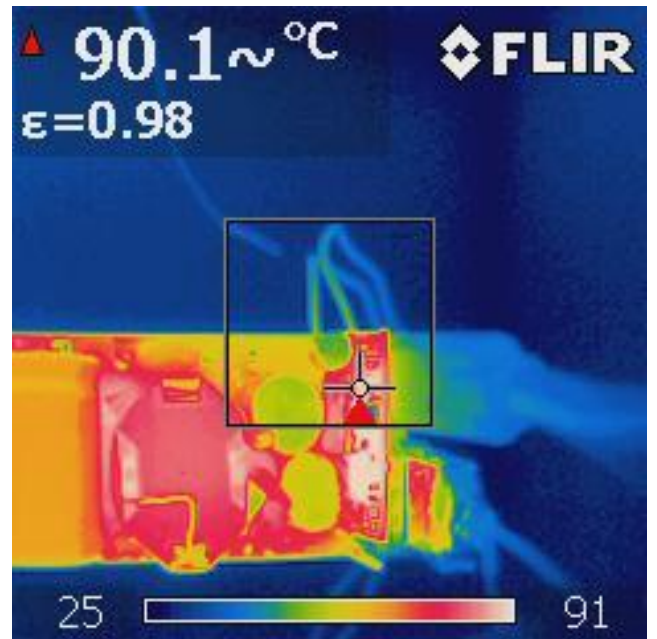

Figure 49 – Buck-boost Inductor (L23): 90.1 °C.

11.2.2 265 VAC Input USB-C: 20 V / 1.5 A, USB-A: 5 V / 2.4 A

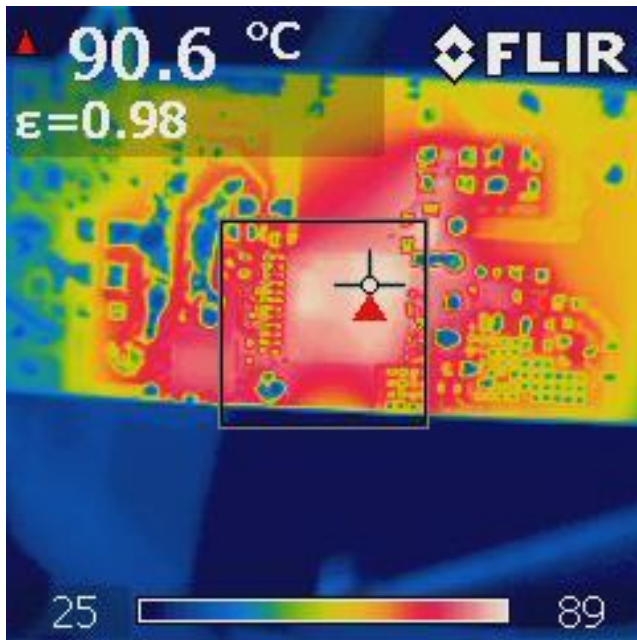

Figure 50 – InnoSwitch3-Pro (U1): 90.6 °C.

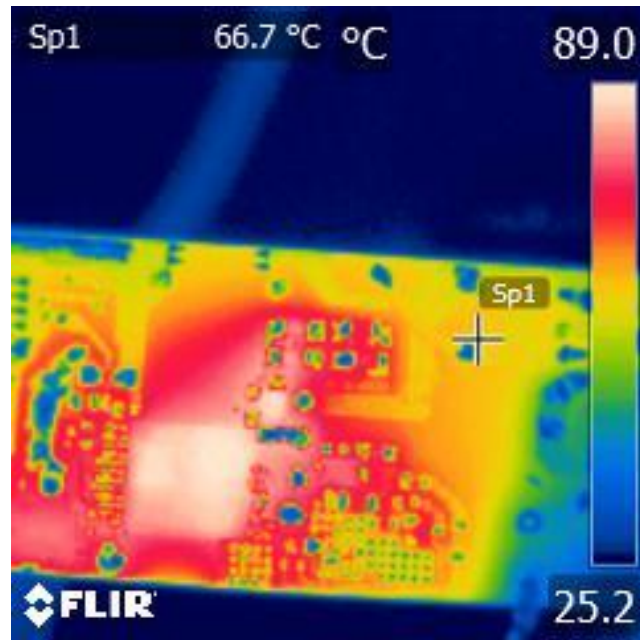

Figure 51 – Bridge Diode (BR1): 66.7 °C.

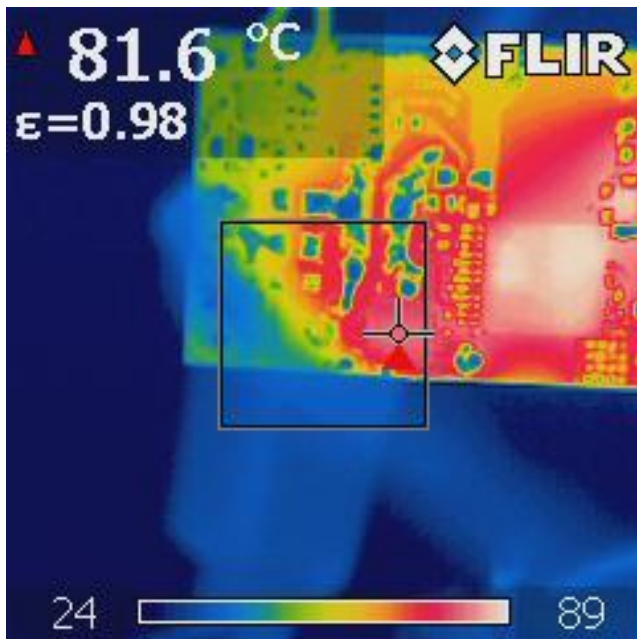

Figure 52 – SRFET (Q2): 81.6 °C.

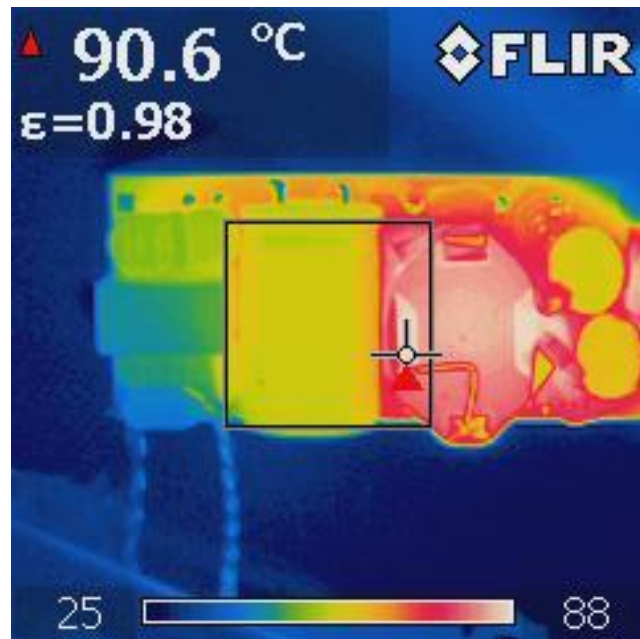

Figure 53 – Transformer (T1): 90.6 °C.

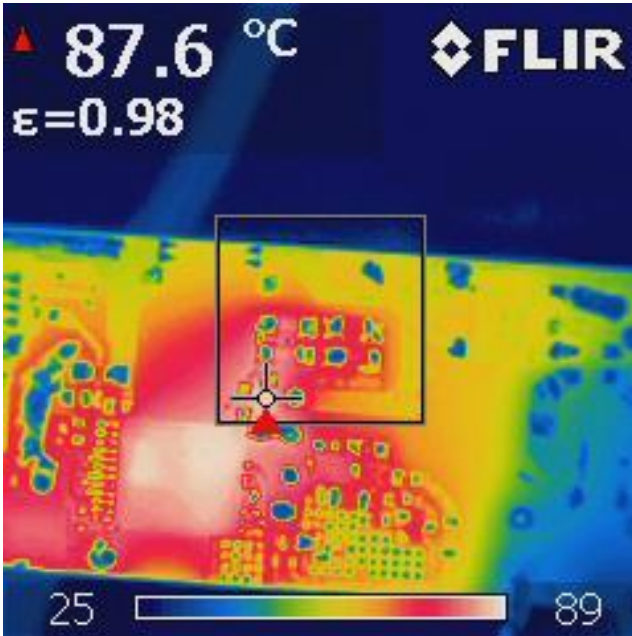

Figure 54 – Snubber Diode (D1): 87.6 °C.

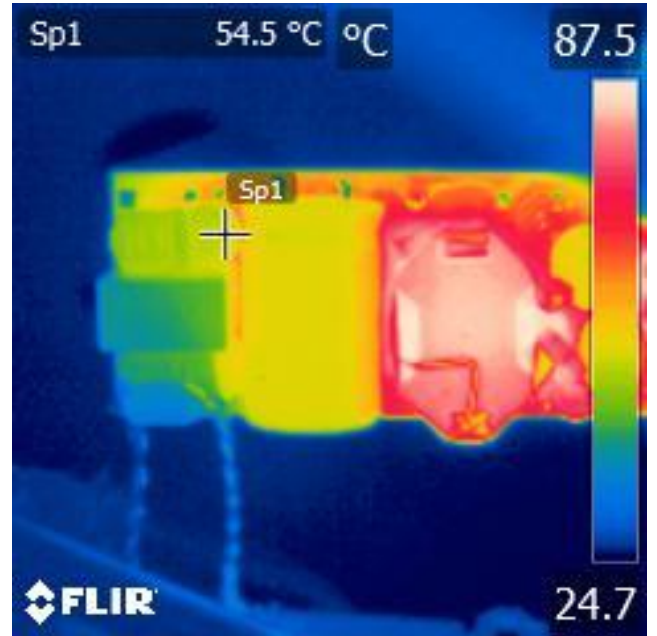

Figure 55 – Input CMC (L2): 54.5 °C.

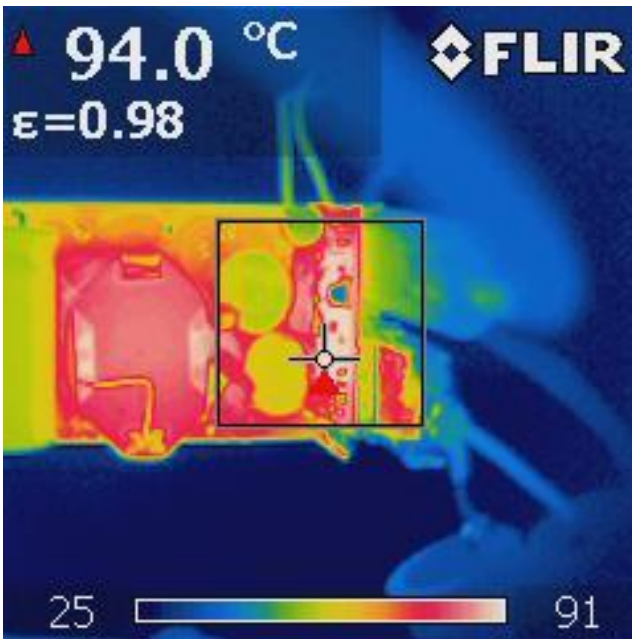

Figure 56 – Buck-Boost IC (U4): 94 °C.

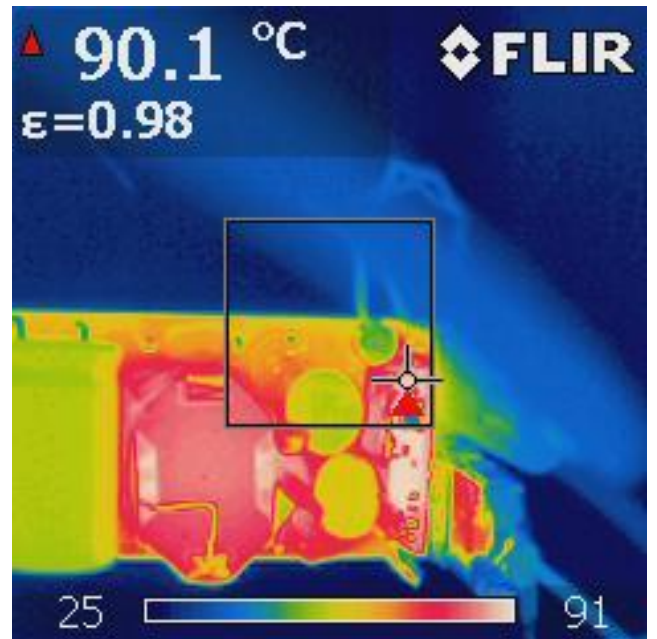

Figure 57 – Buck-boost Inductor (L3): 90.1 °C.

11.2.3 90 VAC Input USB-C: 9 V / 3 A, USB-A: 5 V / 2.4 A

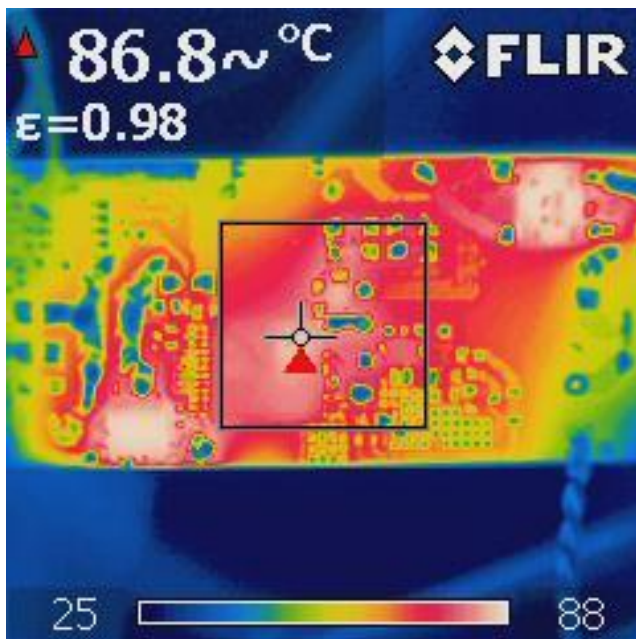

Figure 58 – InnoSwitch3-Pro: 86.8 °C.

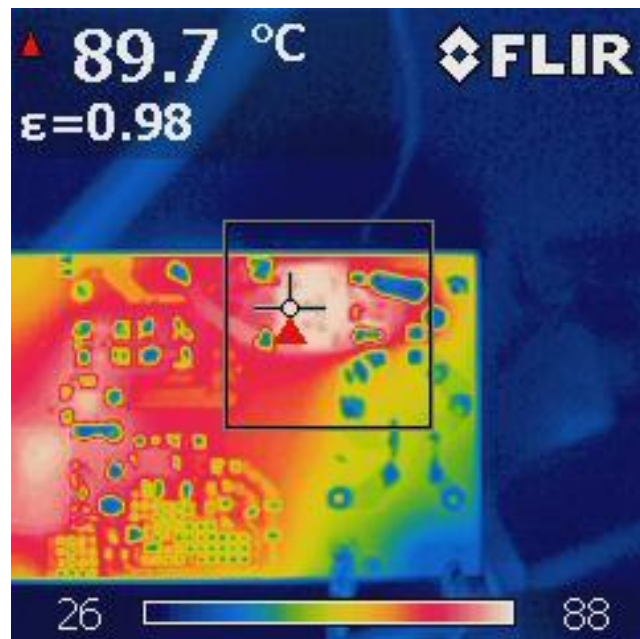

Figure 59 – Bridge Diode (BR1): 89.7 °C.

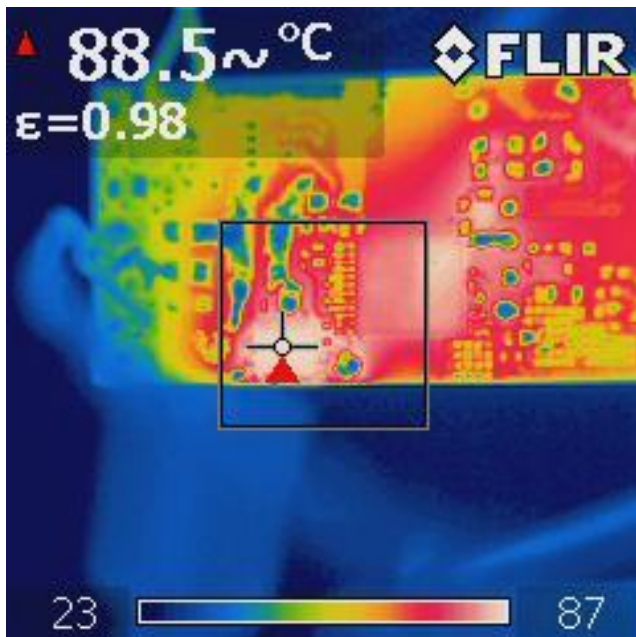

Figure 60 – SRFET (Q2): 88.5 °C.

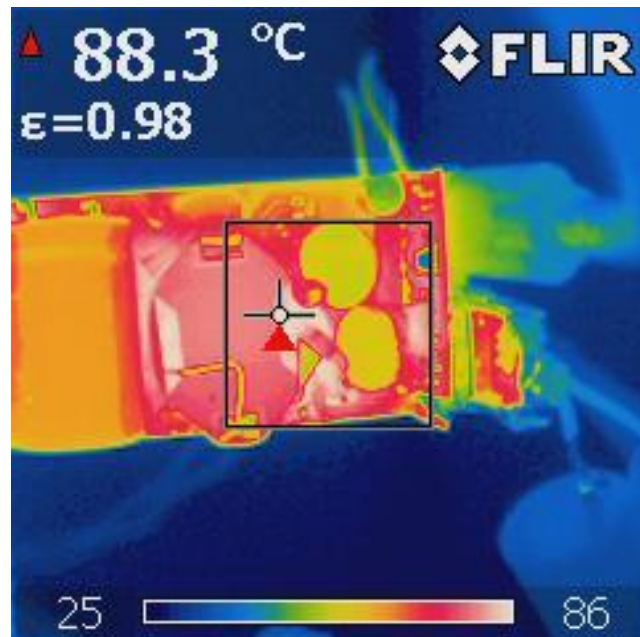

Figure 61 – Transformer (T1): 88.3 °C.

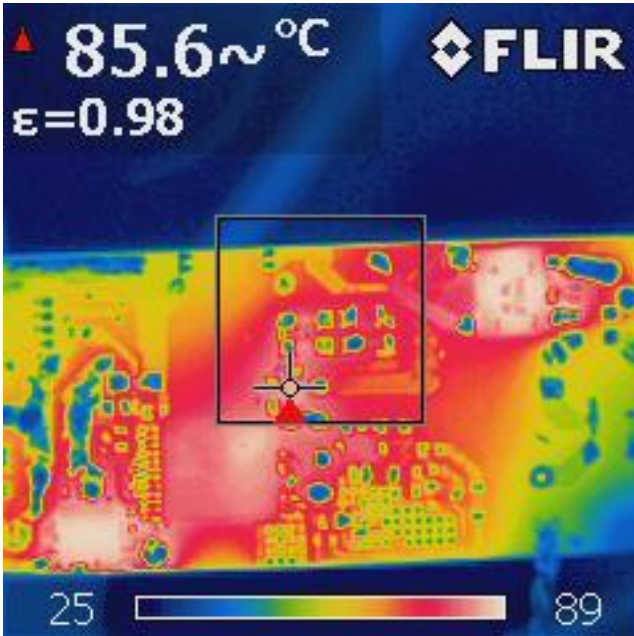

Figure 62 – Snubber Diode (D1): 85.6 °C.

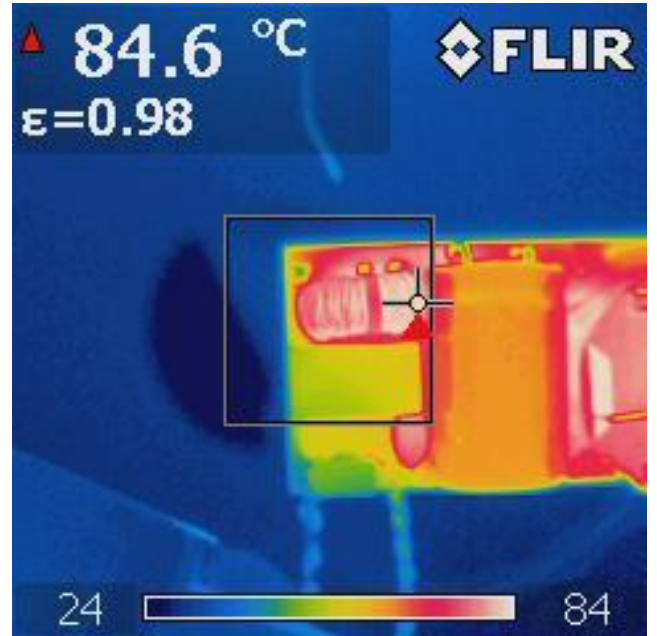

Figure 63 – Input CMC (L2): 84.6 °C.

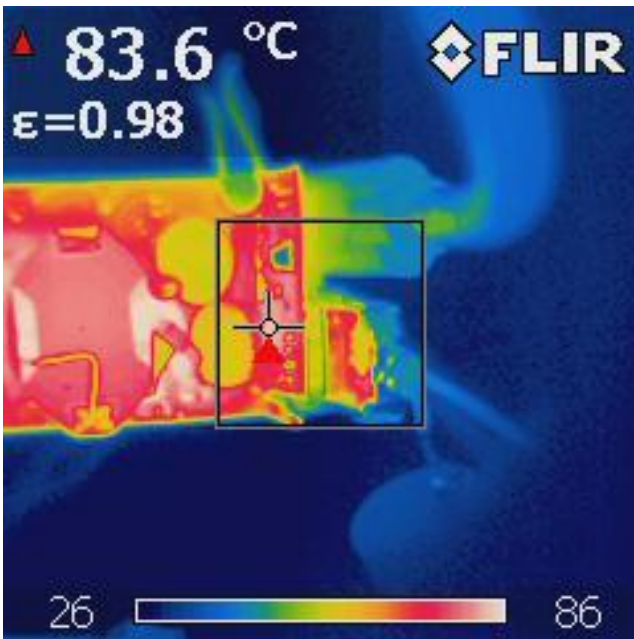

Figure 64 – Buck-Boost IC (U4): 83.6 °C.

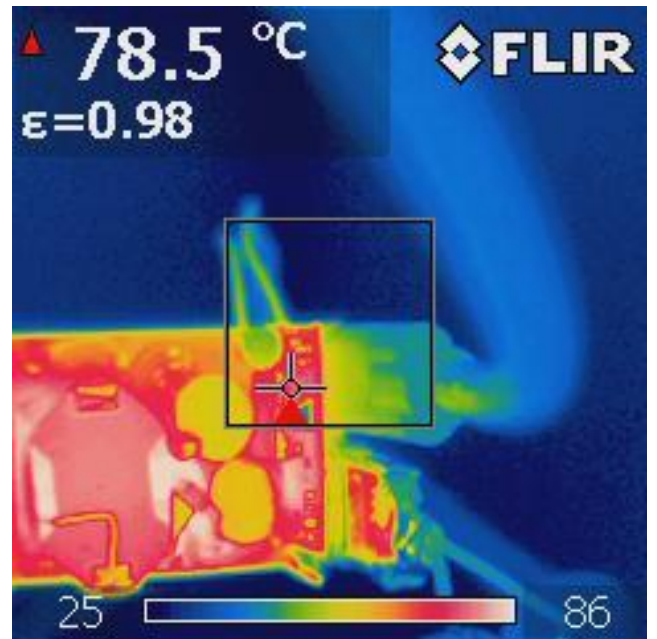

Figure 65 – Buck-boost Inductor (L23): 78.5 °C.

11.2.4 265 VAC Input USB-C: 9 V / 3 A, USB-A: 5 V / 2.4 A

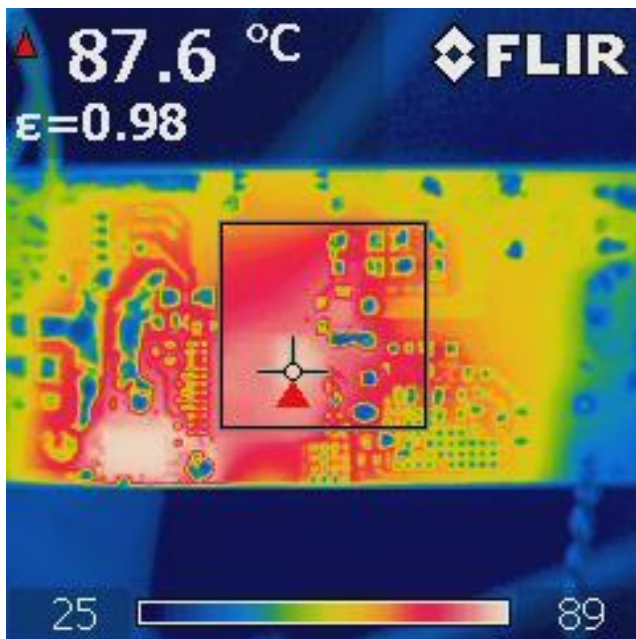

Figure 66 – InnoSwitch3-Pro (U1): 87.6 °C.

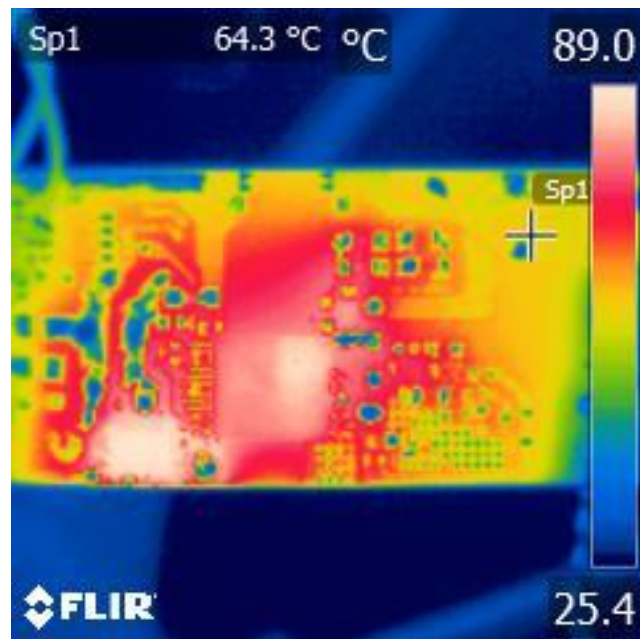

Figure 67 – Bridge Diode (BR1): 64.3 °C.

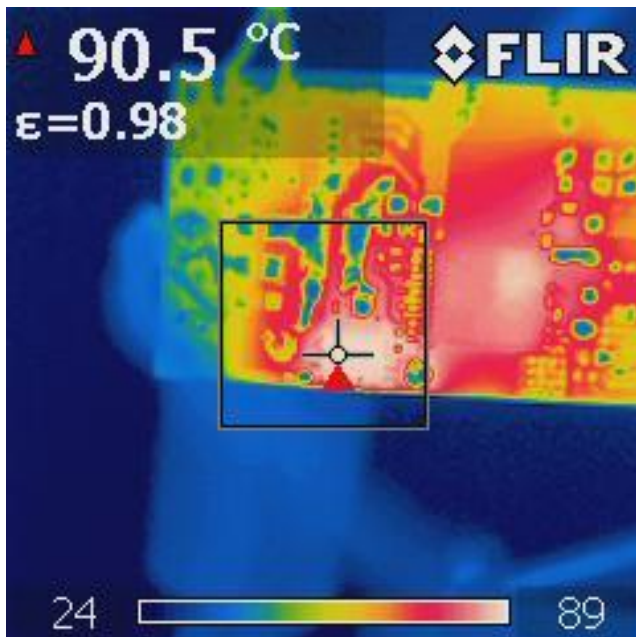

Figure 68 – SRFET (Q2): 90.5 °C.

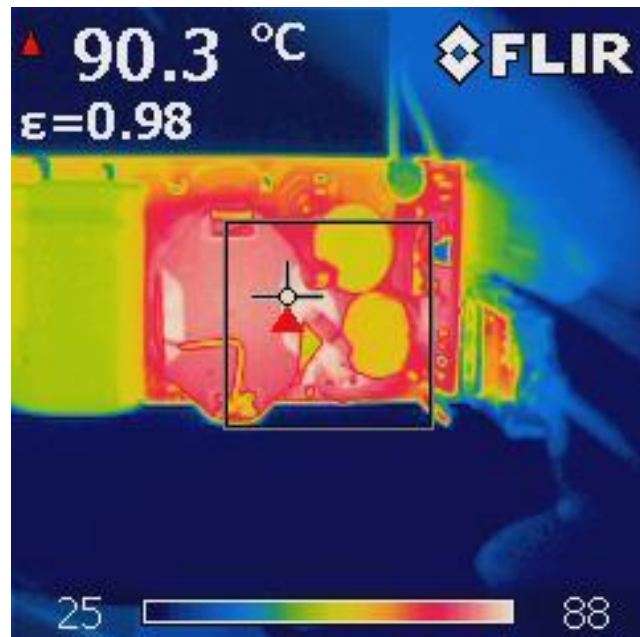

Figure 69 – Transformer (T1): 90.3 °C.

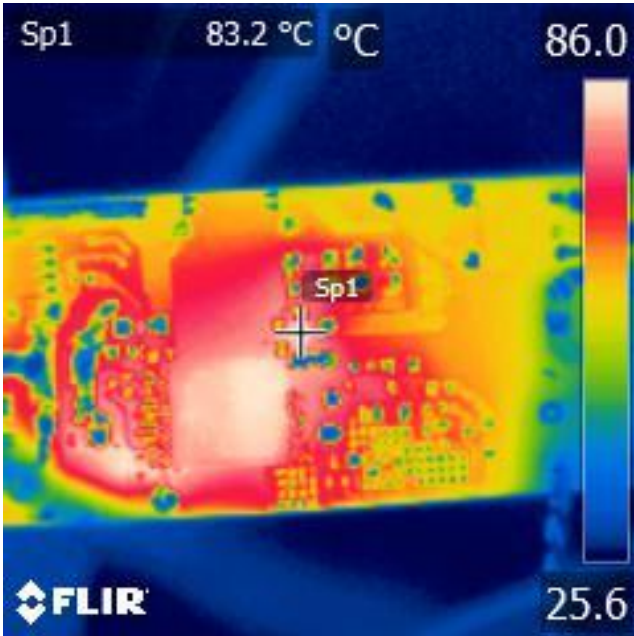

Figure 70 – Snubber Diode (D1): 83.2 °C.

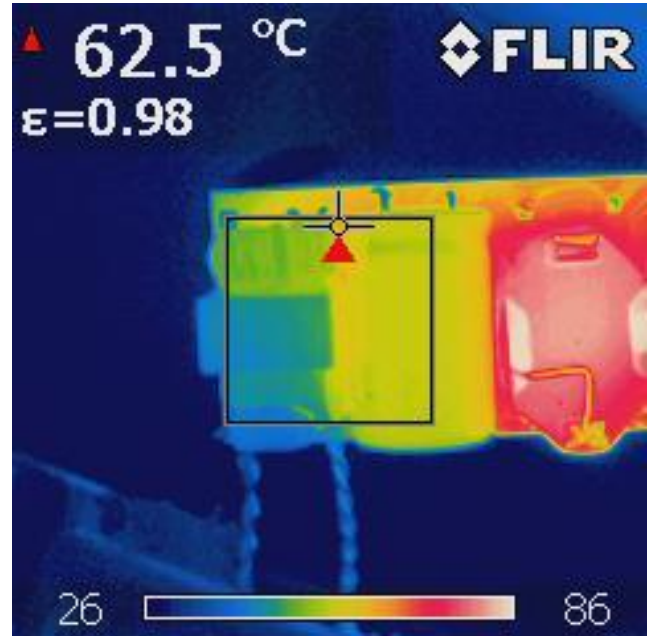

Figure 71 – Input CMC (L2): 62.5 °C.

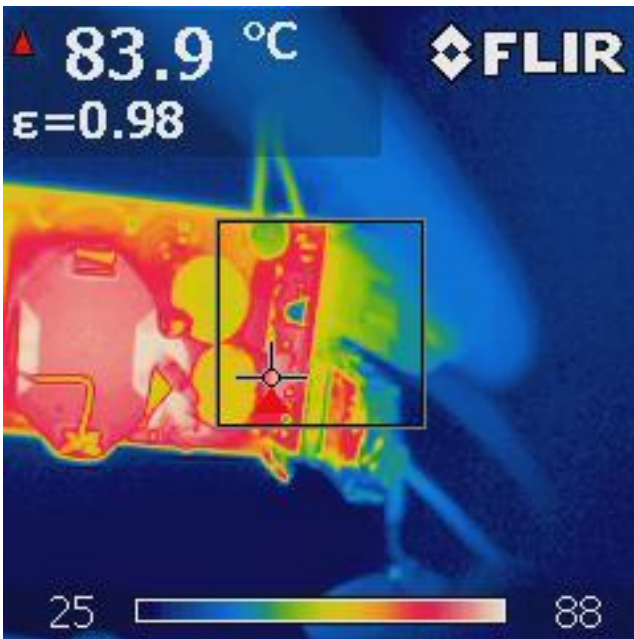

Figure 72 – Buck-Boost IC (U4): 83.9 °C.

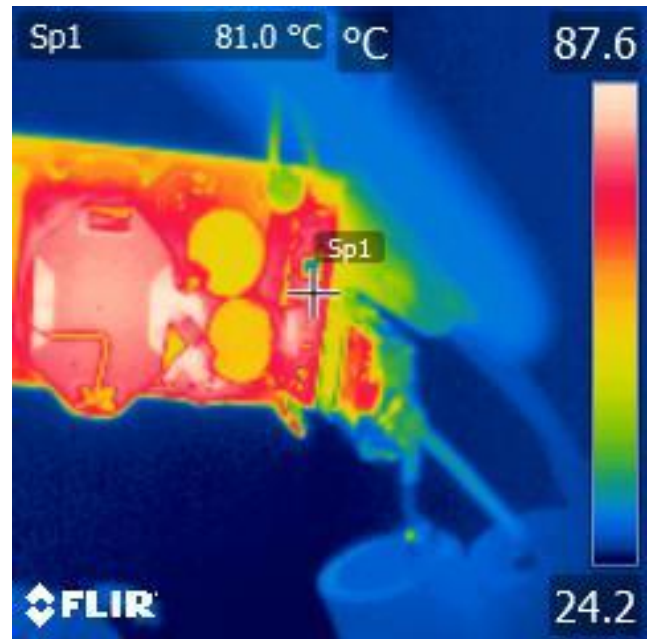

Figure 73 – Buck-boost Inductor (L3): 81 °C.

11.3 **Thermal Performance at 50 °C Chamber Ambient Temperature**

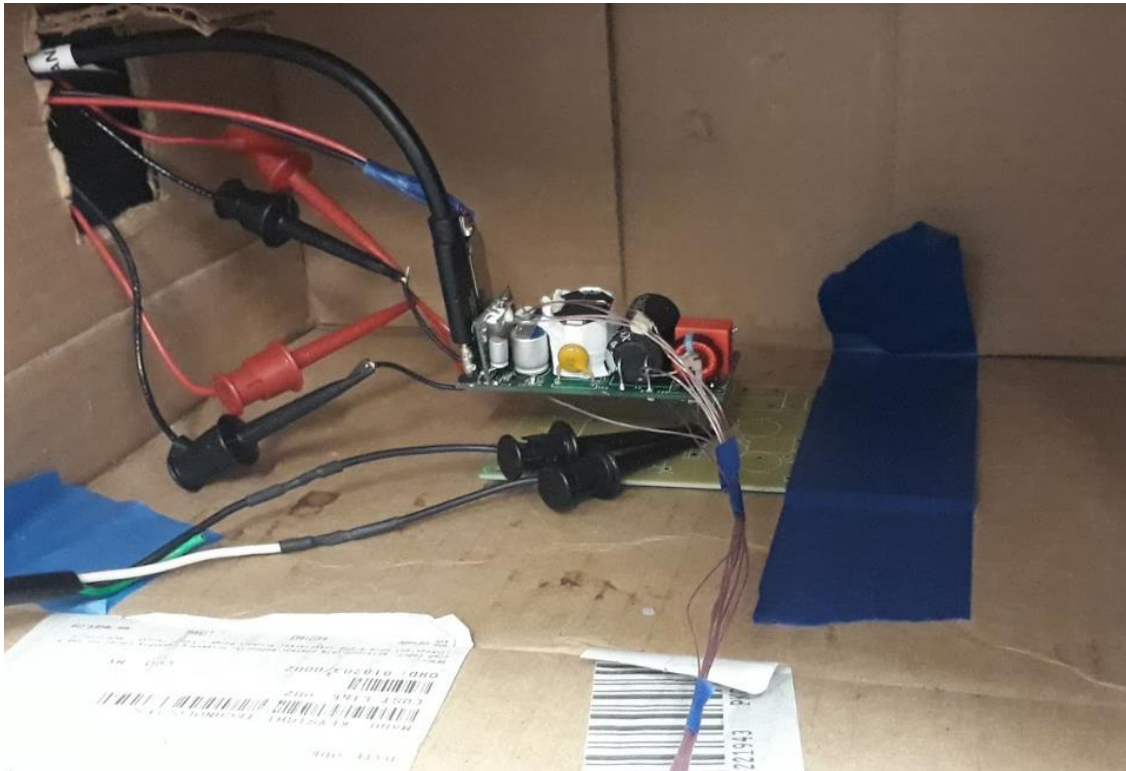

Figure 74 – Test Set-up Picture Thermal at 50 °C Ambient.

Components	Temperature (°C)										Max (°C)	Remarks
	USB-C:20 V		USB-C:15 V		USB-C:12 V		USB-C:9 V		USB-C:5 V			
	90 V 60 Hz	265 V 50 Hz	90 V 60 Hz	265 V 50 Hz	90 V 60 Hz	265 V 50 Hz	90 V 60 Hz	265 V 50 Hz	90 V 60 Hz	265 V 50 Hz		
InnoSwitch3-Pro (U1)	115.9	118.4	112.5	114.5	112.9	114.3	112	111.9	100.2	102	118.4	Pass
SRFET (Q2)	102.7	104.3	103.2	104.4	105.6	107.2	109.1	109.9	108	108.8	109.9	Pass
Transformer	110.5	112.6	108.8	109.9	109.3	111.4	109.3	110.3	102.1	103.5	112.6	Pass
Input CMC (L2)	119.6	84.4	118.4	83.1	118.5	83.3	112.8	81.5	92.4	74.7	119.6	Pass
Bridge (BR1)	114.6	90	113.6	87.8	113.5	88.2	109.7	86.1	94.3	79.1	114.6	Pass
Buck Boost IC	113.8	115.2	107.7	108.5	104.9	105.8	103.6	104	105.6	105.9	115.2	Pass
Buck Boost (L3)	114.7	114.9	108.7	108.7	105.6	106.2	103	103.4	103.7	103.8	114.9	Pass
Ambient	52.3	52.1	52.7	52.2	52.4	52	52.6	52.3	56.5	52.1	56.5	Pass

11.3.1 Component Thermal Profile at USB-C: 20 V / 1.5 A, USB-A: 5 V / 2.4 A

11.3.1.1 $V_{IN} = 90 \text{ VAC } 60 \text{ Hz}$

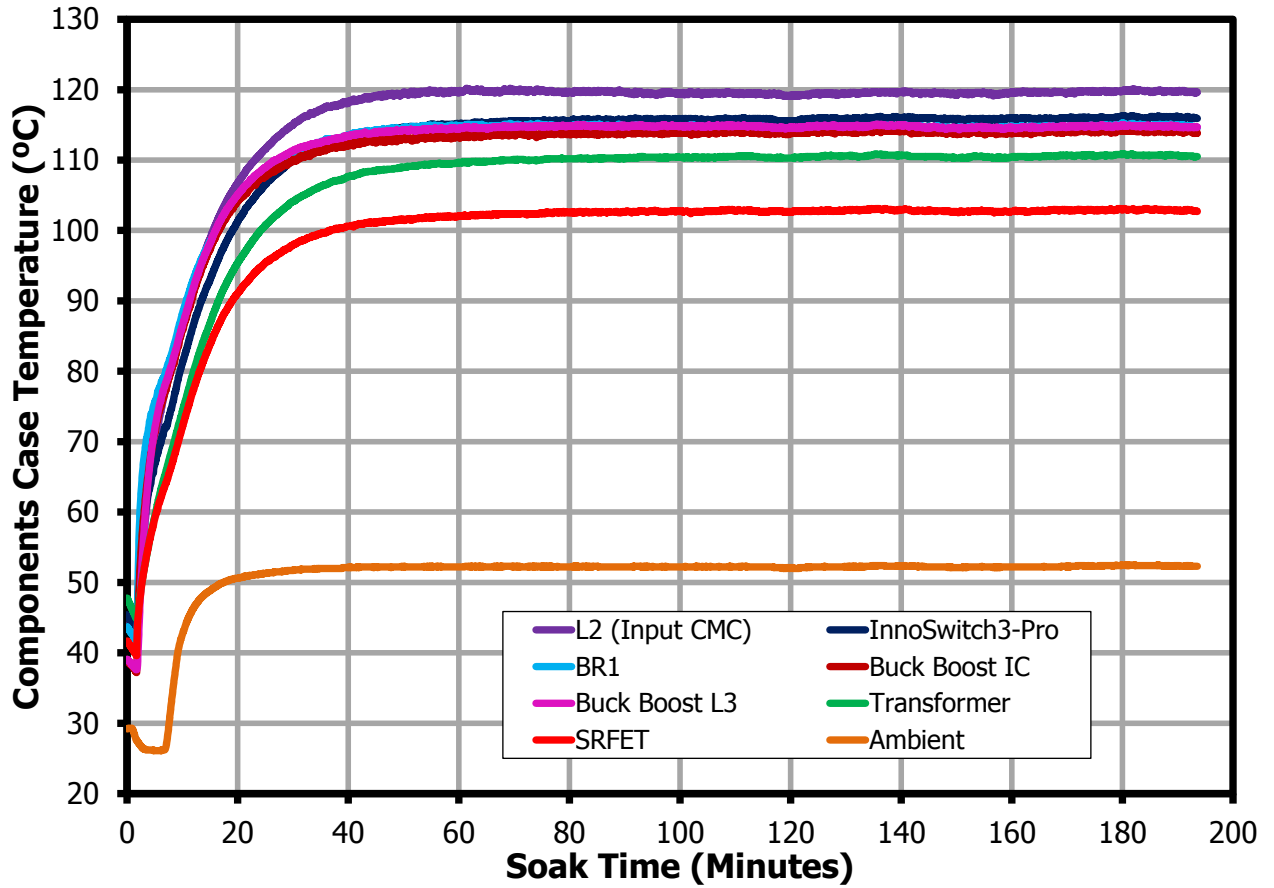

Figure 75 – 90 VAC, USB-C: 20 V / 1.5 A, USB-A: 5 V / 2.4 A.



11.3.1.2 $V_{IN} = 265 \text{ VAC } 50 \text{ Hz}$

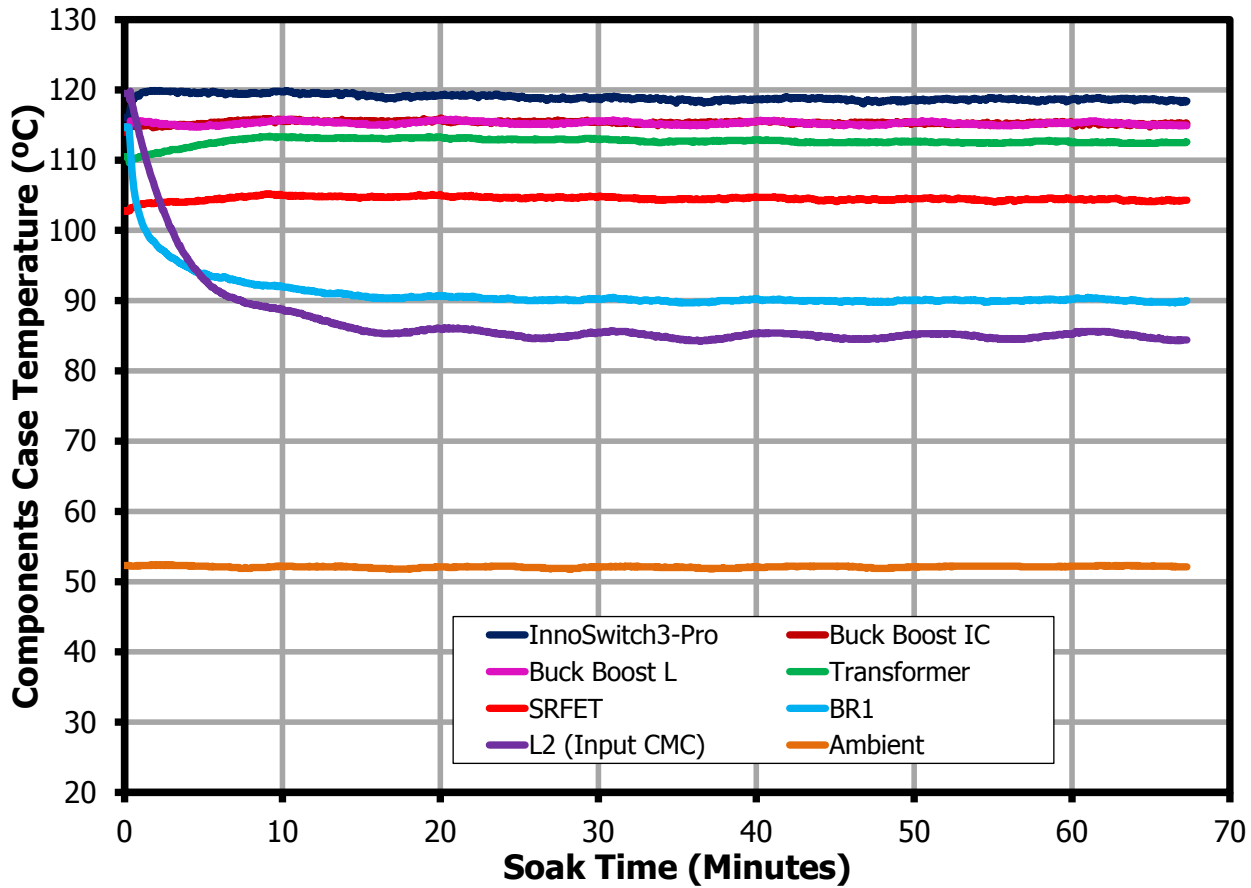

Figure 76 – 265 VAC, USB-C: 20 V / 1.5 A, USB-A: 5 V / 2.4 A.

11.3.2 Component Thermal Profile at USB-C: 12 V / 2.5 A, USB-A: 5 V / 2.4 A

11.3.2.1 $V_{IN} = 90 \text{ VAC } 60 \text{ Hz}$

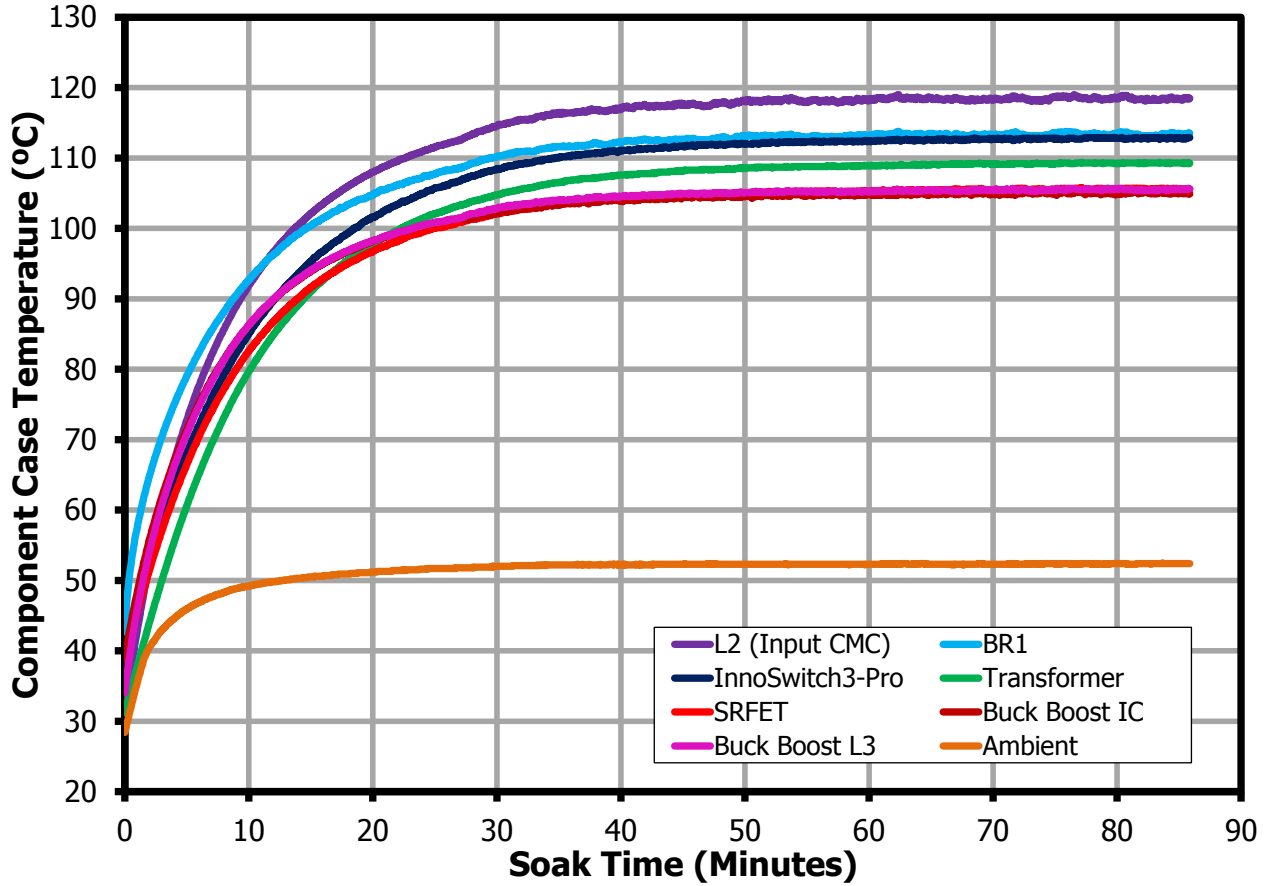

Figure 77 – 90 VAC, USB-C: 12 V / 2.5 A, USB-A: 5 V / 2.4 A.



11.3.2.2 $V_{IN} = 265 \text{ VAC } 50 \text{ Hz}$

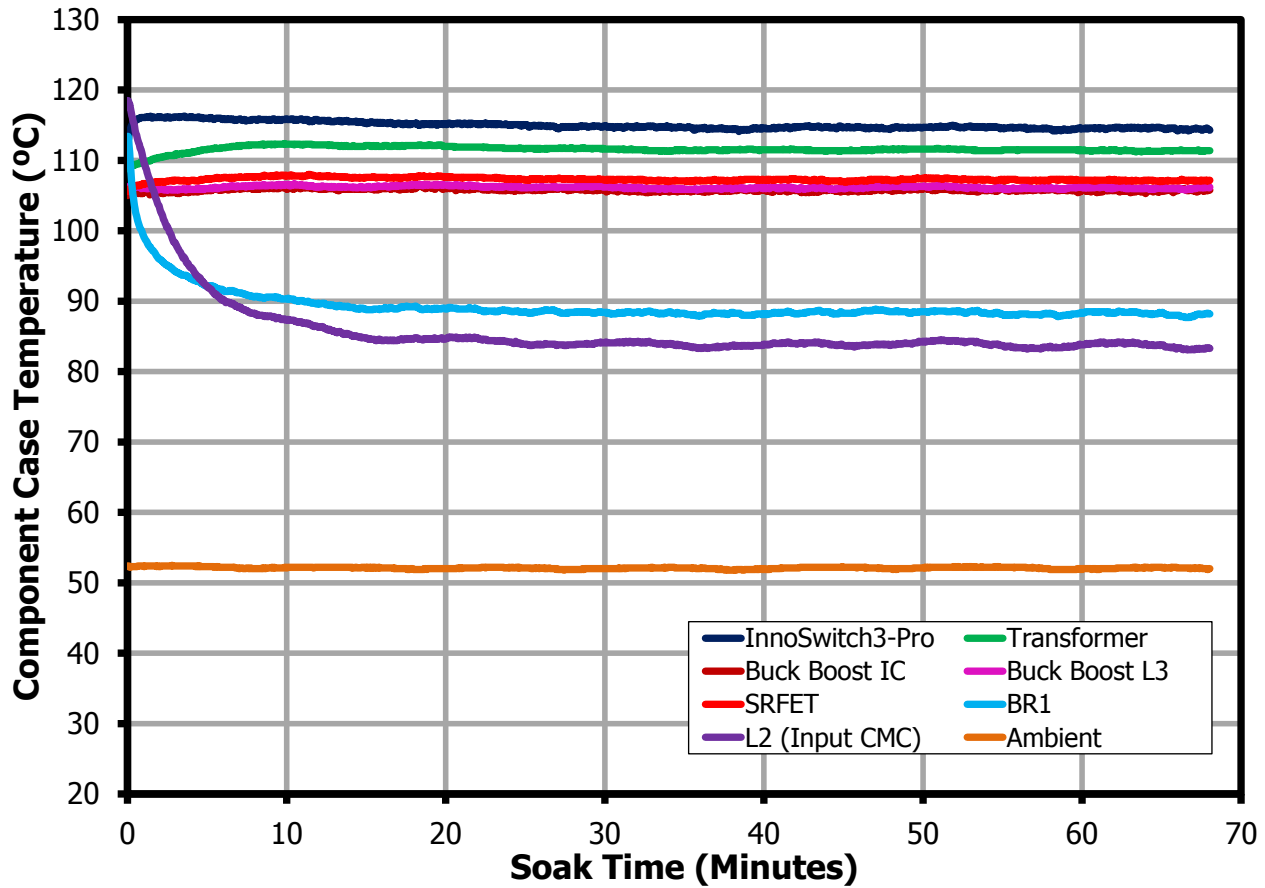

Figure 78 – 265 VAC, USB-C: 12 V / 2.5 A, USB-A: 5 V / 2.4 A.

11.3.3 Component Thermal Profile at USB-C: 9 V / 3 A, USB-A: 5 V / 2.4 A

11.3.3.1 $V_{IN} = 90 \text{ VAC } 60 \text{ Hz}$

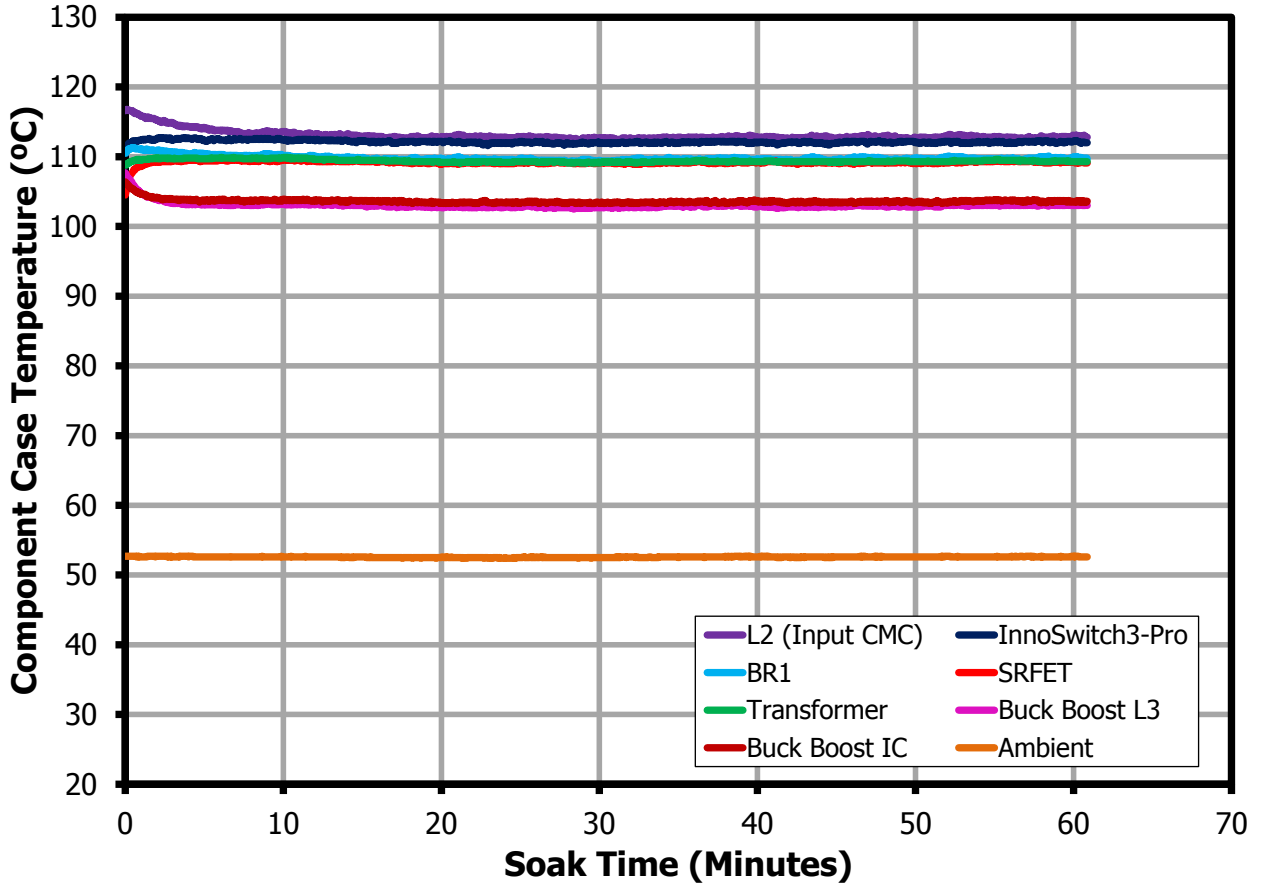

Figure 79 – 90 VAC, USB-C: 9 V / 3 A, USB-A: 5 V / 2.4 A.



11.3.3.2 $V_{IN} = 265 \text{ VAC } 50 \text{ Hz}$

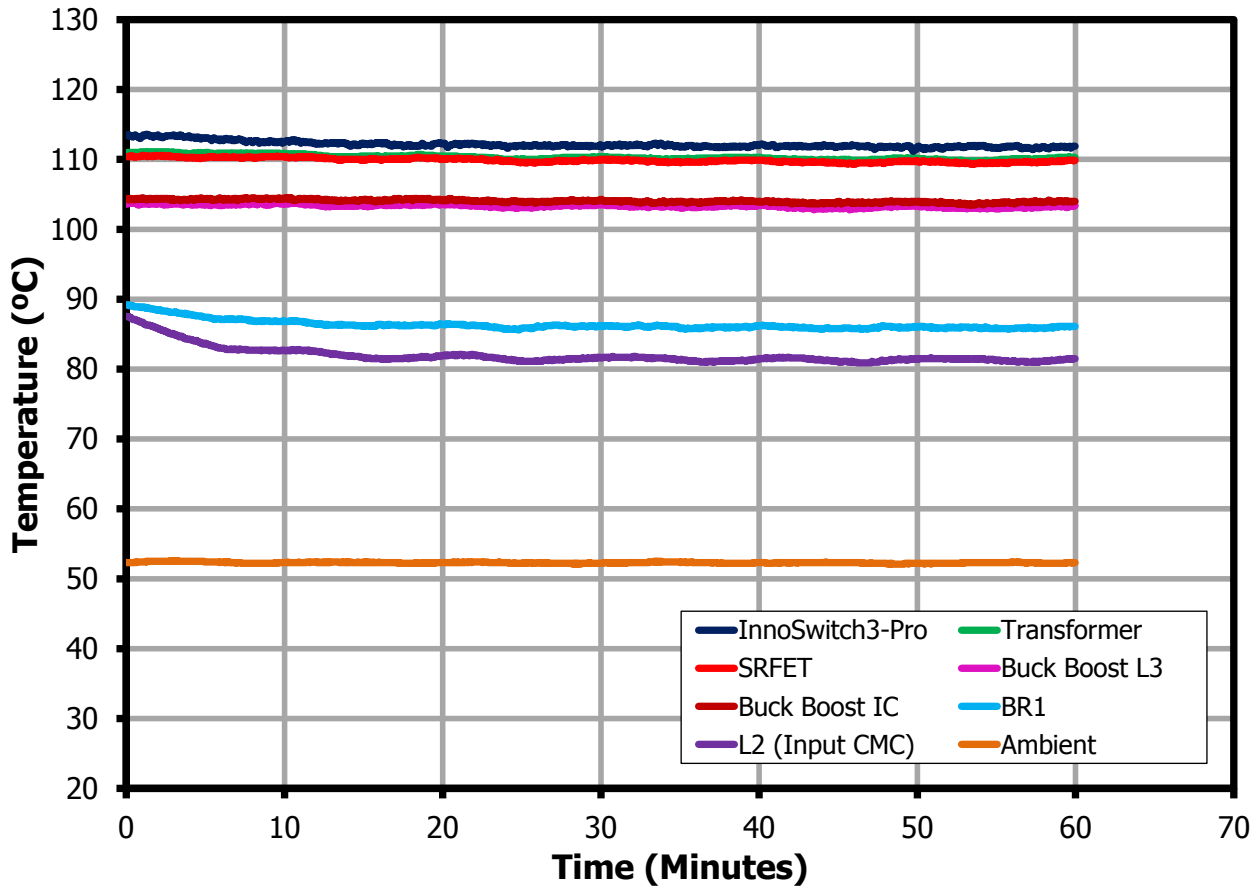

Figure 80 – 265 V AC, USB-C: 9 V / 3 A, USB-A: 5 V / 2.4 A.

11.3.4 OTP Test at USB-C: 20 V / 1.5 A, USB-A: 5 V / 2.4 A

Final Data	Temperature (°C) - OTP at 90 VAC							USB-C (V)
	Ambient	InnoPro	BR1	SRFET	TRF	Buck Boost IC	Buck Boost Inductor	
OTP-Point	77.7	139.9	134.1	125.9	131.7	136.4	135.3	20.133
OTP Recovery	35.1	68.7	62.9	65	72.2	61.8	62.3	4.88

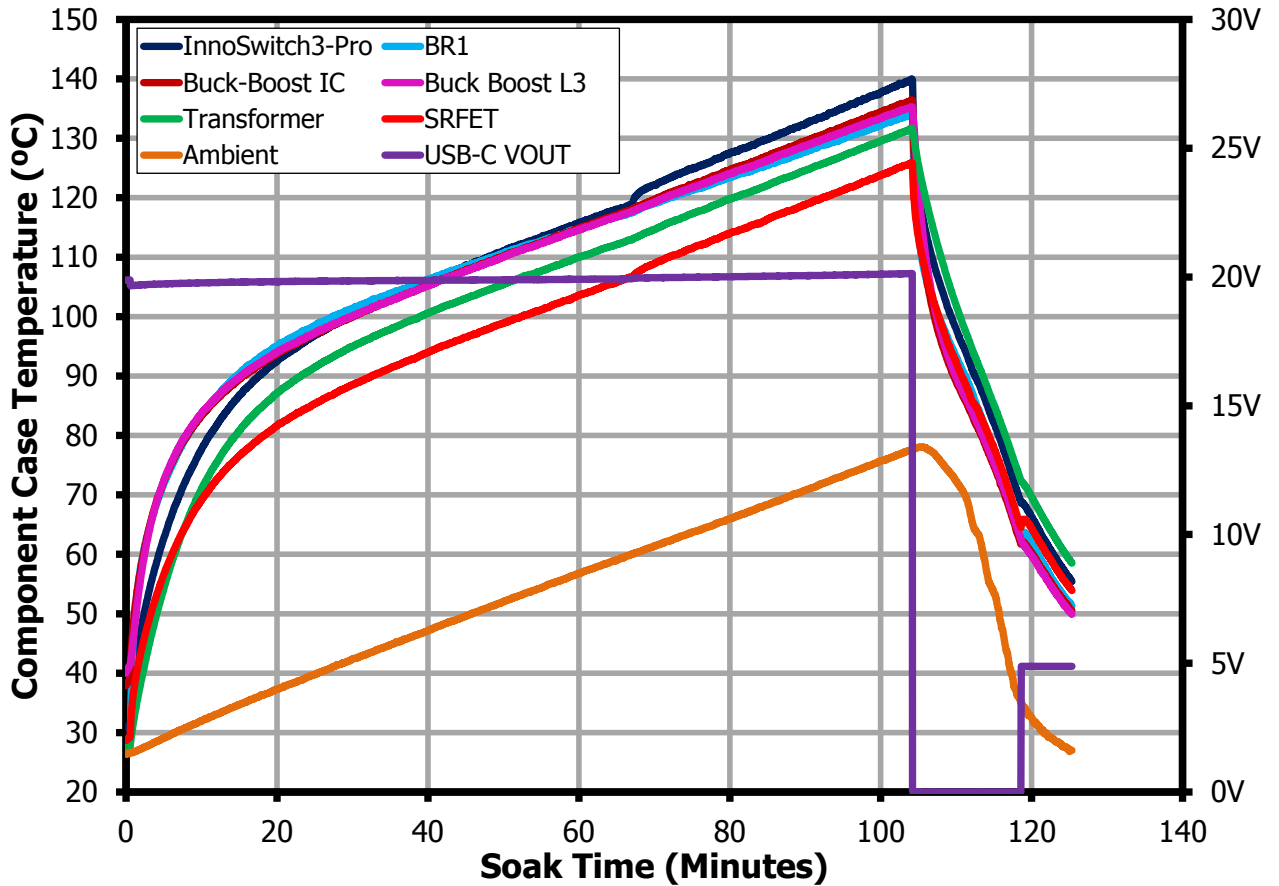

Figure 81 – OTP Thermal Profile at 90 VAC 60 Hz.



Final Data	Temperature (°C) - OTP at 265 VAC							USB-C (V)
	Ambient	InnoPro	BR1	SRFET	TRF	Buck Boost IC	Buck Boost L3	
OTP-Point	69.6	140.1	105.3	123.6	132	131.7	130.2	20.1V
OTP Recovery	38.5	69.4	62.1	65.4	68.7	63.4	63.7	4.9 V

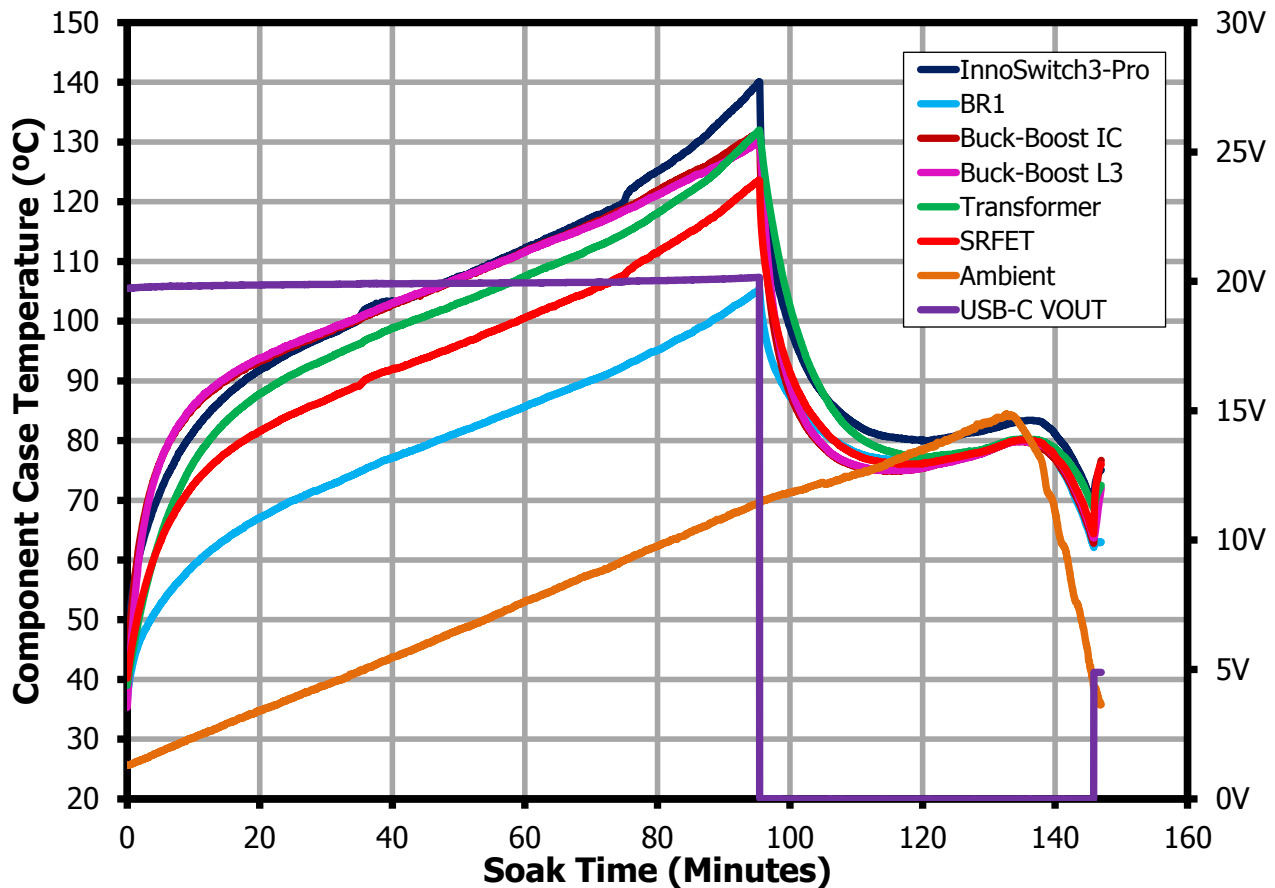

Figure 82 – OTP Thermal Profile at 265 VAC 50 Hz.



12 Waveforms

12.1 Start-up Profile at USB-C 5 V / 3 A

USB-C Load: 3 A CC Mode load, USB-A Load: 2.4 A CC Mode Load

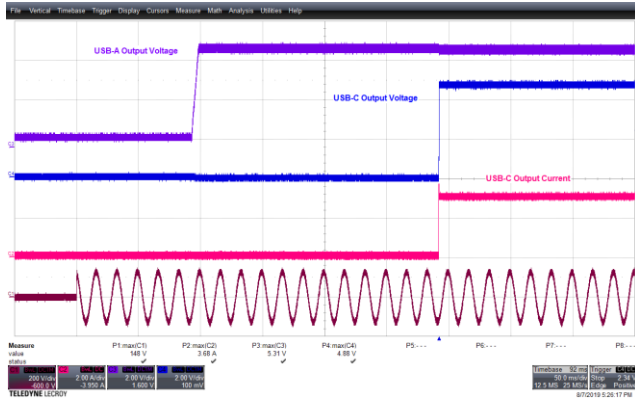

Figure 83 – 90 VAC 60 Hz, 5 V Full Load Start-up.
 CH1(Brown): V_{IN} , 200 V / div., 50 ms / div
 CH2(Pink): I_{USB-C} , 2 A / div.
 CH3(Violet): V_{USB-A} , 2 V / div.
 CH4(Blue): V_{USB-C} , 2 V / div.
 USB-C Turn-On Delay = 290 ms.

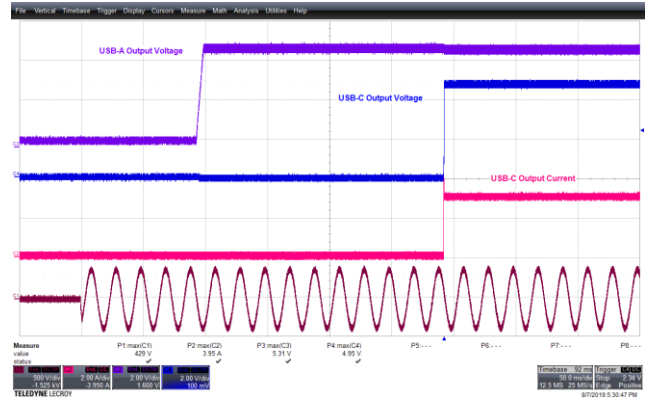

Figure 84 – 265 VAC 50 Hz, 5 V Full Load Start-up.
 CH1(Brown): V_{IN} , 200 V / div., 50 ms / div
 CH2(Pink): I_{USB-C} , 2 A / div.
 CH3(Violet): V_{USB-A} , 2 V / div.
 CH4(Blue): V_{USB-C} , 2 V / div.
 USB-C Turn-On Delay = 290 ms.

12.2 USB-C Transient Voltage Step Change (5 V - 9 V - 12 V - 15 V - 20 V)

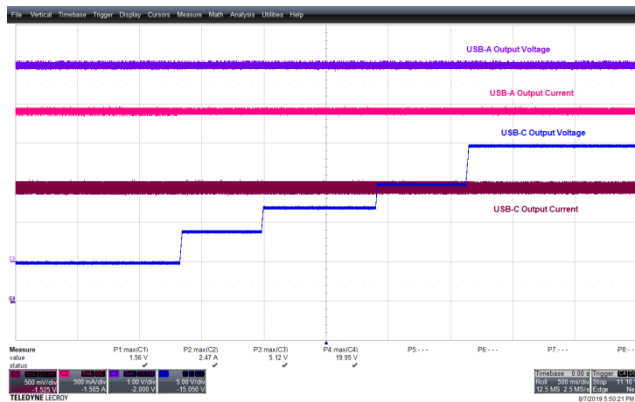

Figure 85 – 90 VAC 60 Hz, 5 V - 9 V - 12 V - 15 V - 20 V Step.
 CH1(Brown): I_{USB-C} , 500 mA / div.,
 CH2(Pink): I_{USB-A} , 500 mA / div.
 CH3(Violet): V_{USB-A} , 1 V / div. 500 ms / div.
 CH4(Blue): V_{USB-C} , 5 V / div.
 Remark: No overshoot/undershoot.

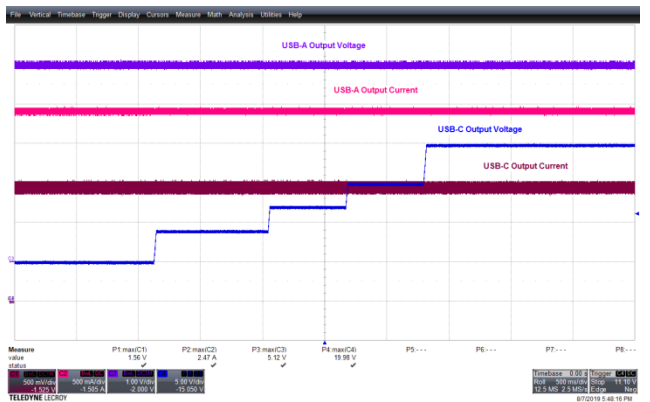

Figure 86 – 265 VAC 60 Hz, 5 V - 9 V - 12 V - 15 V - 20 V Step.
 CH1(Brown): I_{USB-C} , 500 mA / div.,
 CH2(Pink): I_{USB-A} , 500 mA / div.
 CH3(Violet): V_{USB-A} , 1 V / div. 500 ms / div.
 CH4(Blue): V_{USB-C} , 5 V / div.
 Remark: No overshoot/undershoot.



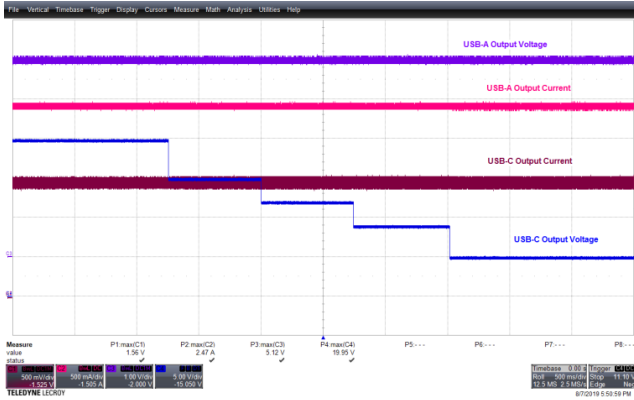

Figure 87 – 90 VAC 60 Hz, 20 V - 15 V - 12 V - 9 V - 5 V.

CH1(Brown): I_{USB-C} , 500 mA / div.
 CH2(Pink): I_{USB-A} , 500 mA / div.
 CH3(Violet): V_{USB-A} , 1 V / div., 500 ms.
 CH4(Blue): V_{USB-C} , 5 V / div.

Remark: No overshoot/undershoot.

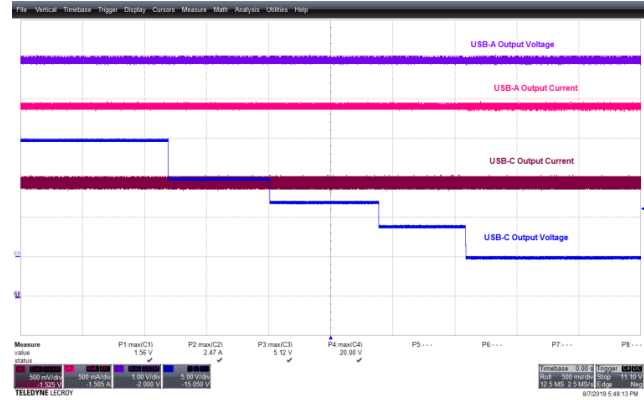

Figure 88 – 265 VAC 60 Hz, 20 V - 15 V - 12 V - 9 V - 5 V.

CH1(Brown): I_{USB-C} , 500 mA / div.
 CH2(Pink): I_{USB-A} , 500 mA / div.
 CH3(Violet): V_{USB-A} , 1 V / div., 500 ms.
 CH4(Blue): V_{USB-C} , 5 V / div.

Remark: No overshoot /undershoot.

12.3 USB-C Transient Voltage Step Change (5 V - 20 V)

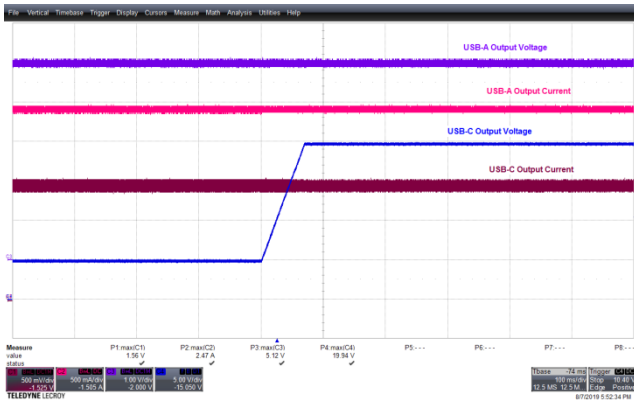

Figure 89 – 90 VAC 60 Hz, 5 – 20 V USB-C Step
 CH1(Brown): I_{USB-C} , 500 mA / div.
 CH2(Pink): I_{USB-A} , 500 mA / div.
 CH3(Violet): V_{USB-A} , 1 V / div., 500 ms.
 CH4(Blue): V_{USB-C} , 5 V / div.

Remark: No overshoot/undershoot.

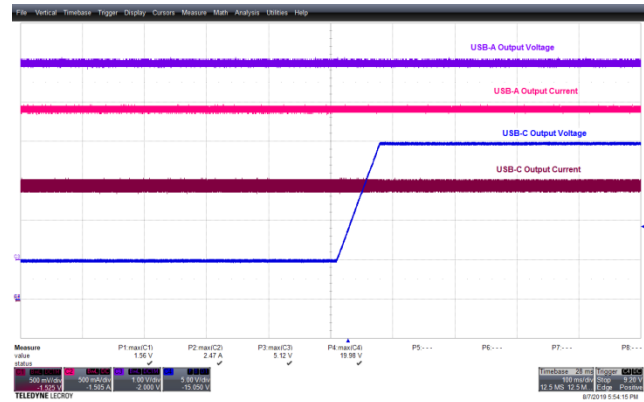

Figure 90 – 265 VAC 60 Hz, 5 – 20 V USB-C Step
 CH1(Brown): I_{USB-C} , 500 mA / div.
 CH2(Pink): I_{USB-A} , 500 mA / div.
 CH3(Violet): V_{USB-A} , 1 V / div., 500 ms.
 CH4(Blue): V_{USB-C} , 5 V / div.

Remark: No overshoot /undershoot.

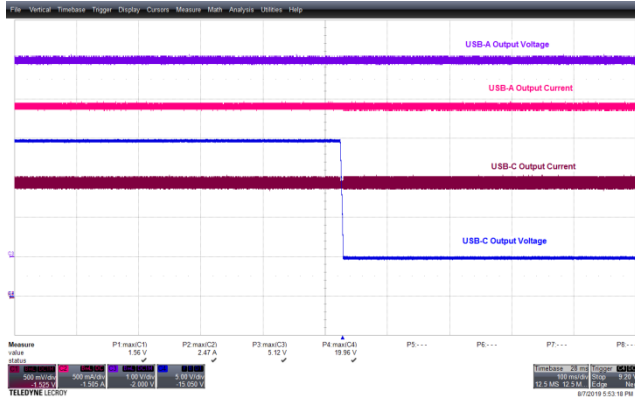

Figure 91 – 90 VAC 60 Hz, 20 – 5 V USB-C Step
 CH1(Brown): I_{USB-C} , 500 mA / div.
 CH2(Pink): I_{USB-A} , 500 mA / div.
 CH3(Violet): V_{USB-A} , 1 V / div., 500 ms.
 CH4(Blue): V_{USB-C} , 5 V / div.
 Remark: No overshoot/undershoot.

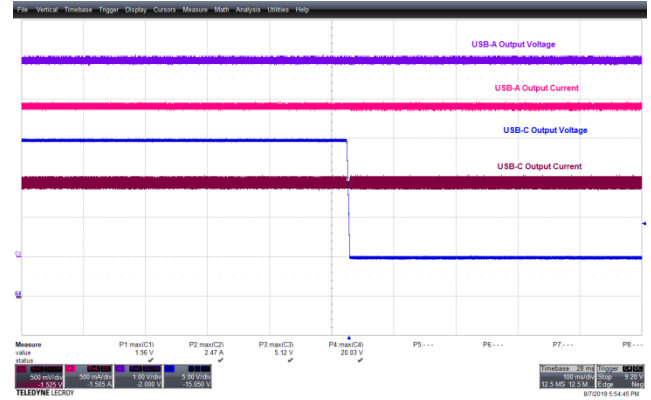

Figure 92 – 265 VAC 60 Hz, 20 – 5 V USB-C Step.
 CH1(Brown): I_{USB-C} , 500 mA / div.
 CH2(Pink): I_{USB-A} , 500 mA / div.
 CH3(Violet): V_{USB-A} , 1 V / div., 500 ms.
 CH4(Blue): V_{USB-C} , 5 V / div.
 Remark: No overshoot /undershoot.

12.4 Transient Load Response

See chapter 9.10 transient load test data.

12.4.1 USB Type-C Transient Load at $V_{USB-C} = 5 V$

Duty Cycle: 50%, Frequency = 100 Hz, Slew Rate = 200 mA / μ s, $I_{USB-A}=2.4 A$,

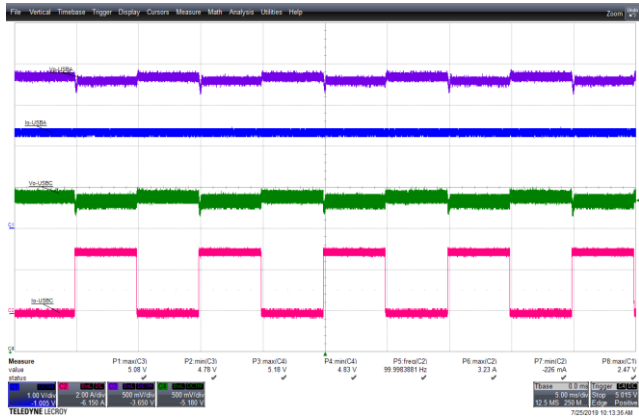

Figure 93 – 90 VAC 60 Hz, 0-3 A USB-C Transient Load
 CH1(Blue): I_{USB-A} , 1 A / div., 5 ms / div.
 CH2(Pink): I_{USB-C} , 2 A / div.
 CH3(Violet): V_{USB-A} , 0.5 V / div.
 CH4(Green): V_{USB-C} , 0.5 V / div.

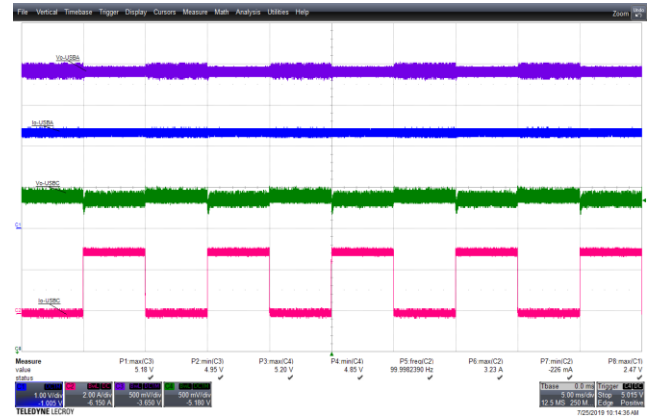

Figure 94 – 265 VAC 50 Hz, 0-3 A USB-C Transient Load
 CH1(Blue): I_{USB-A} , 1 V / div., 5 ms / div.
 CH2(Pink): I_{USB-C} , 2 A / div.
 CH3(Violet): V_{USB-A} , 0.5 V / div.
 CH4(Green): V_{USB-C} , 0.5 V / div.



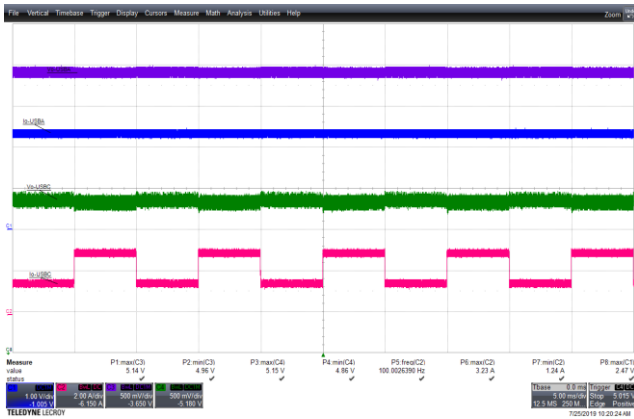

Figure 95 – 90 VAC 60 Hz, 1.5-3 A USB-C Transient.
 CH1(Blue): I_{USB-A} , 1 A / div., 5 ms / div.
 CH2(Pink): I_{USB-C} , 2 A / div.
 CH3(Violet): V_{USB-A} , 0.5 V / div.
 CH4(Green): V_{USB-C} , 0.5 V / div.

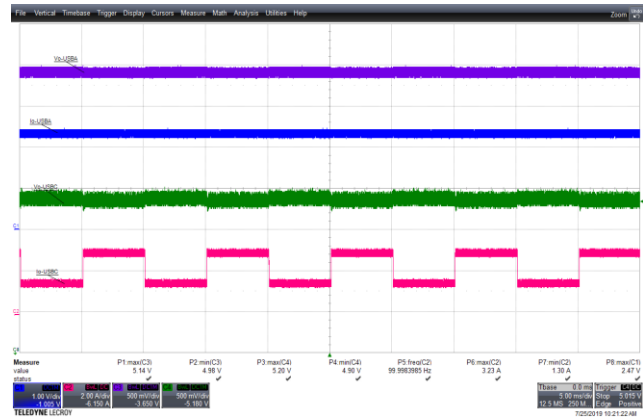

Figure 96 – 265 VAC 50 Hz, 1.5-3 A USB-C Transient.
 CH1(Blue): I_{USB-A} , 1 V / div., 5 ms / div.
 CH2(Pink): I_{USB-C} , 2 A / div.
 CH3(Violet): V_{USB-A} , 0.5 V / div.
 CH4(Green): V_{USB-C} , 0.5 V / div.

12.4.2 USB Type-C Transient Load at $V_{USB-C} = 20$ V

Duty Cycle: 50%, Frequency = 100 Hz, Slew Rate = 200 mA / μ S, I_{USB-A} =2.4 A,

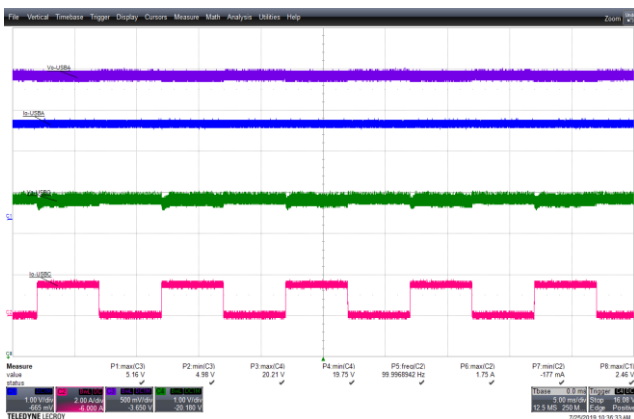

Figure 97 – 90 VAC 60 Hz, 0-1.5 A USB-C Transient.
 CH1(Blue): I_{USB-A} , 1 A / div., 5 ms / div.
 CH2(Pink): I_{USB-C} , 2 A / div.
 CH3(Violet): V_{USB-A} , 0.5 V / div.
 CH4(Green): V_{USB-C} , 1 V / div.

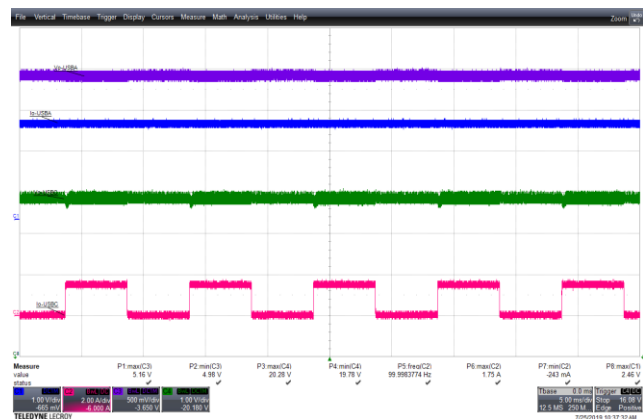

Figure 98 – 265 VAC 50 Hz, 0-1.5 A USB-C Transient.
 CH1(Blue): I_{USB-A} , 1 V / div., 5 ms / div.
 CH2(Pink): I_{USB-C} , 2 A / div.
 CH3(Violet): V_{USB-A} , 0.5 V / div.
 CH4(Green): V_{USB-C} , 1 V / div.

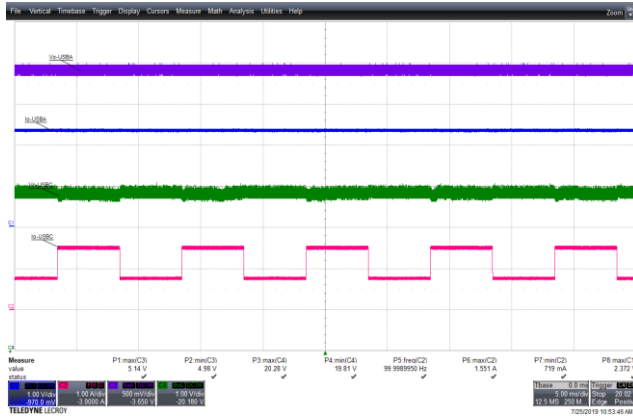

Figure 99 – 90 VAC 60 Hz, 0.75-1.5 A USB-C Transient.
 CH1(Blue): I_{USB-Ar} 1 A / div., 5 ms / div.
 CH2(Pink): I_{USB-Cr} 1 A / div.
 CH3(Violet): V_{USB-A} , 0.5 V / div.
 CH4(Green): V_{USB-C} , 1 V / div.

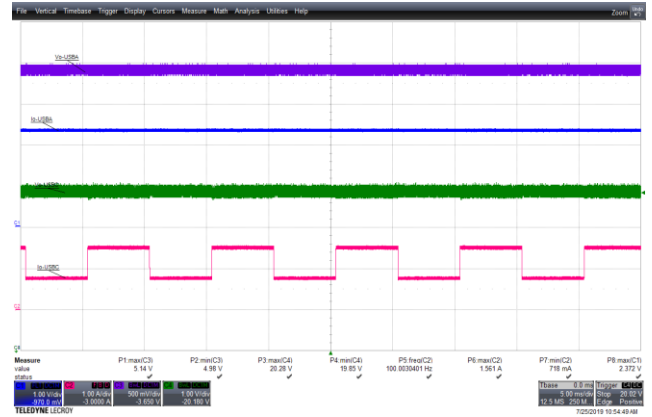

Figure 100 – 265 VAC 50 Hz, 0.75-1.5 A USB-C Transient.
 CH1(Blue): I_{USB-Ar} 1 V / div., 5 ms / div.
 CH2(Pink): I_{USB-Cr} 1 A / div.
 CH3(Violet): V_{USB-A} , 0.5 V / div.
 CH4(Green): V_{USB-C} , 1 V / div.

12.4.3 USB Type-A Transient Load at $V_{USB-C} = 5\text{ V}$

Duty Cycle: 50%, Frequency = 100 Hz, Slew Rate = 200 mA / μs , $I_{USB-C}=3\text{ A}$,

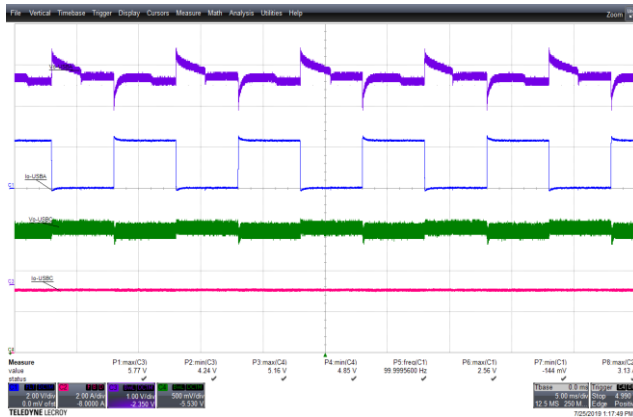

Figure 101 – 90 VAC 60 Hz, 0-2.4 A USB-A Transient.
 CH1(Blue): I_{USB-Ar} 2 A / div., 5 ms / div.
 CH2(Pink): I_{USB-Cr} 2 A / div.
 CH3(Violet): V_{USB-A} , 1 V / div.
 CH4(Green): V_{USB-C} , 0.5 V / div.

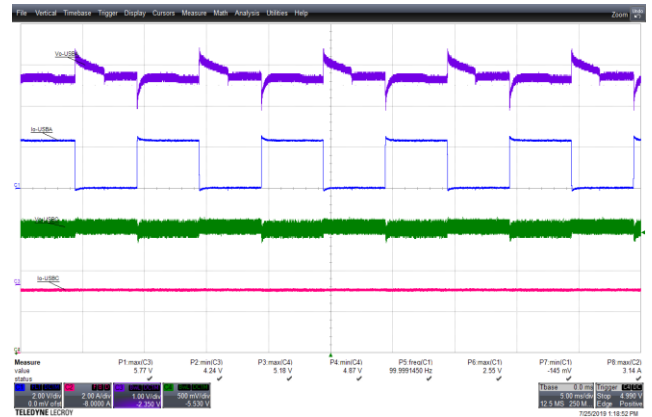

Figure 102 – 265 VAC 50 Hz, 0-2.4 A USB-A Transient.
 CH1(Blue): I_{USB-Ar} 2 V / div., 5 ms / div.
 CH2(Pink): I_{USB-Cr} 2 A / div.
 CH3(Violet): V_{USB-A} , 1 V / div.
 CH4(Green): V_{USB-C} , 0.5 V / div.

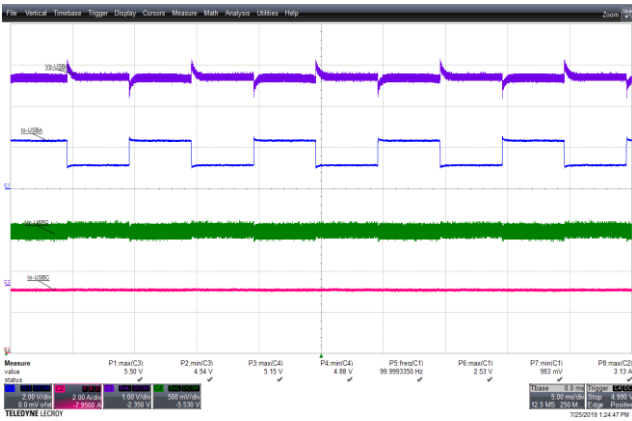

Figure 103 – 90 VAC 60 Hz, 1.2-2.4 A USB-A Transient.
 CH1(Blue): I_{USB-Ar} 2 A / div., 5 ms / div.
 CH2(Pink): I_{USB-Cr} 2 A / div.
 CH3(Violet): V_{USB-A} 1 V / div.
 CH4(Green): V_{USB-C} 0.5 V / div.

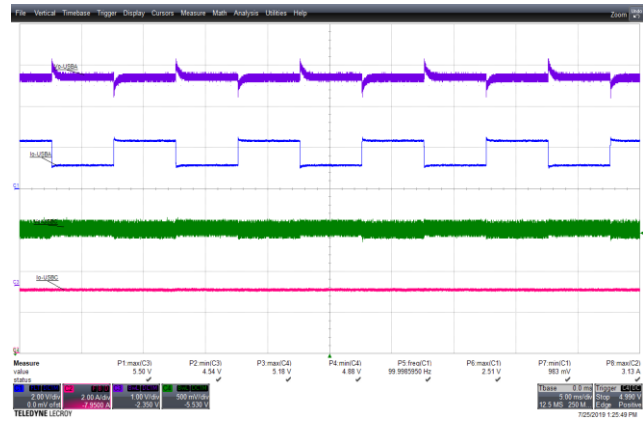

Figure 104 – 265 VAC 50 Hz, 1.2-2.4 A USB-A Transient.
 CH1(Blue): I_{USB-Ar} 2 V / div., 5 ms / div.
 CH2(Pink): I_{USB-Cr} 2 A / div.
 CH3(Violet): V_{USB-A} 1 V / div.
 CH4(Green): V_{USB-C} 0.5 V / div.

12.4.4 USB Type-A Transient Load at $V_{USB-C} = 20$ V

Duty Cycle: 50%, Frequency = 100 Hz, Slew Rate = 200 mA / μ s, $I_{USB-C} = 1.5$ A

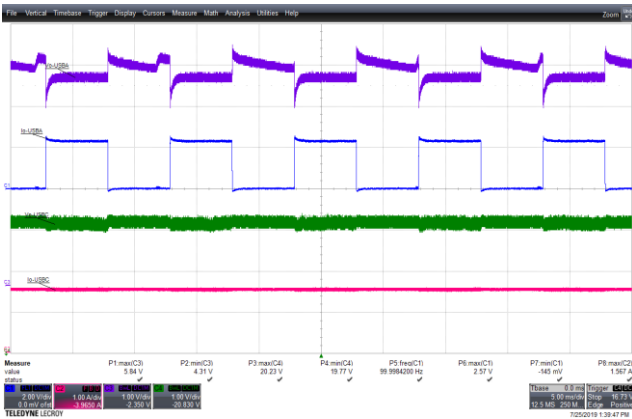

Figure 105 – 90 VAC 60 Hz, 0-2.4 A USB-A Transient.
 CH1(Blue): I_{USB-Ar} 2 A / div., 5 ms / div
 CH2(Pink): I_{USB-Cr} 2 A / div.
 CH3(Violet): V_{USB-A} 1 V / div.
 CH4(Green): V_{USB-C} 0.5 V / div.

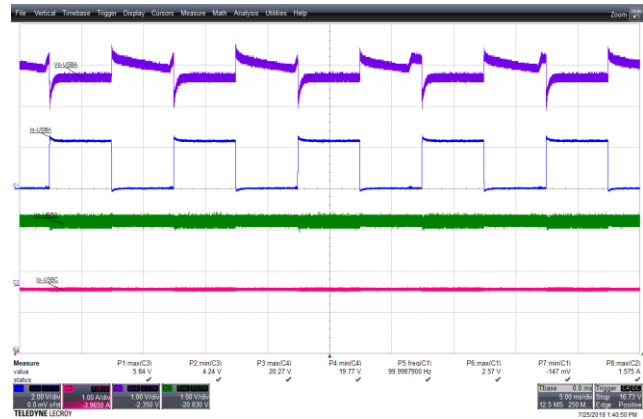

Figure 106 – 265 VAC 50 Hz, 0-2.4 A USB-A Transient.
 CH1(Blue): I_{USB-Ar} 2 V / div., 5 ms / div.
 CH2(Pink): I_{USB-Cr} 2 A / div.
 CH3(Violet): V_{USB-A} 1 V / div.
 CH4(Green): V_{USB-C} 0.5 V / div.

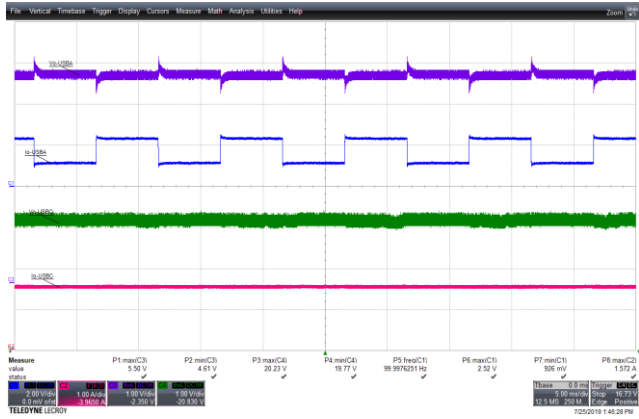

Figure 107 – 90 VAC 60 Hz, 1.2-2.4 A USB-A Transient.
 CH1(Blue): I_{USB-A} , 2 A / div., 5 ms / div.
 CH2(Pink): I_{USB-C} , 2 A / div.
 CH3(Violet): V_{USB-A} , 1 V / div.
 CH4(Green): V_{USB-C} , 0.5 V / div.

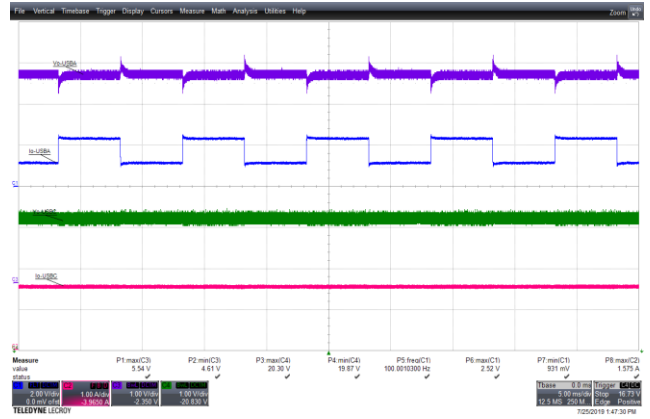

Figure 108 – 265 VAC 50 Hz, 1.2-2.4 A USB-A Transient.
 CH1(Blue): I_{USB-A} , 2 V / div., 5 ms / div.
 CH2(Pink): I_{USB-C} , 2 A / div.
 CH3(Violet): V_{USB-A} , 1 V / div.
 CH4(Green): V_{USB-C} , 0.5 V / div.

12.5 Output Ripple Voltage

See ripple voltage test data at chapter 9.9

12.5.1 Output Ripple Voltage at $V_{USB-C} = 5 V / 3 A$, $V_{USB-A} = 5 V / 2.4 A$

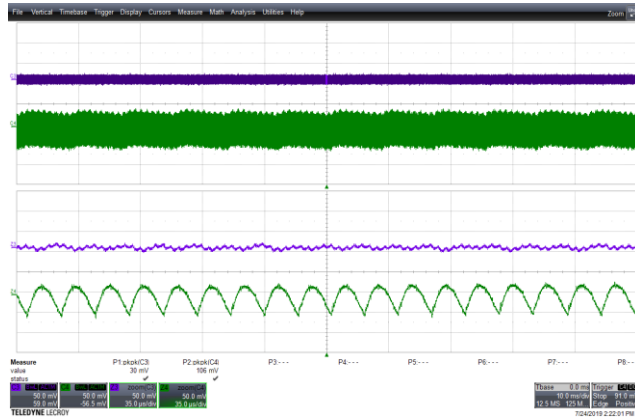

Figure 109 – 90 VAC 60 Hz, Full Load Normal.
 Upper: V_{USB-A} , 50 mV / div., 10 ms / div.
 Lower: V_{USB-C} , 50 mV / div.
 $V_{RIPPLE(USB-A)} = 30 \text{ mVpp}$.
 $V_{RIPPLE(USB-C)} = 106 \text{ mVpp}$.

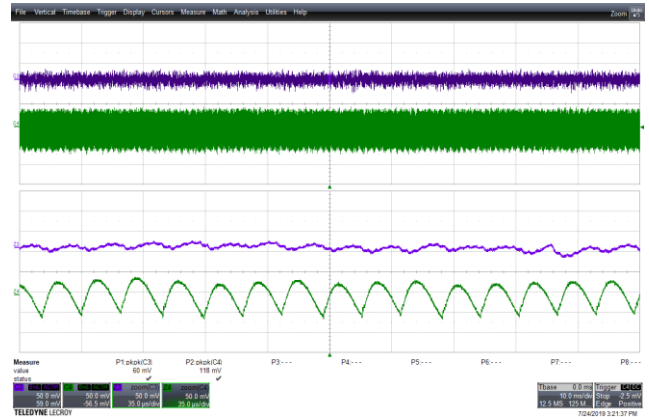

Figure 110 – 265 VAC 50 Hz, Full Load Normal.
 Upper: V_{USB-A} , 50 mV / div., 10 ms / div.
 Lower: V_{USB-C} , 50 mV / div.
 $V_{RIPPLE(USB-A)} = 60 \text{ mVpp}$.
 $V_{RIPPLE(USB-C)} = 118 \text{ mVpp}$.



12.5.2 Output Ripple Voltage at $V_{USB-C} = 9\text{ V} / 3\text{ A}$, $V_{USB-A} = 5\text{ V} / 2.4\text{ A}$

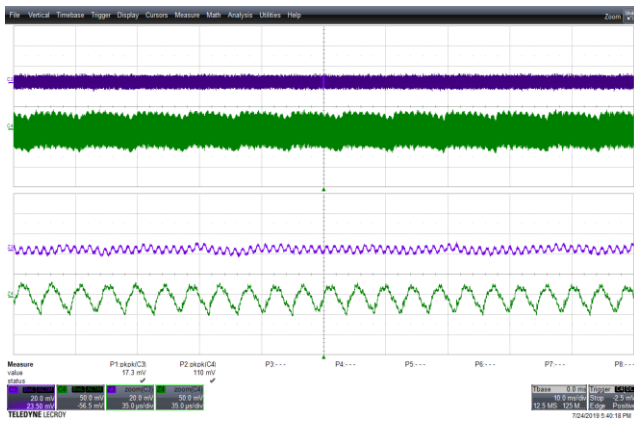

Figure 111 – 90 VAC 60 Hz, Full Load Normal.
 Upper: V_{USB-A} , 50 mV / div., 10 ms / div.
 Lower: V_{USB-C} , 50 mV / div.
 $V_{RIPPLE(USB-A)} = 17.3\text{ mVpp}$.
 $V_{RIPPLE(USB-C)} = 110\text{ mVpp}$.

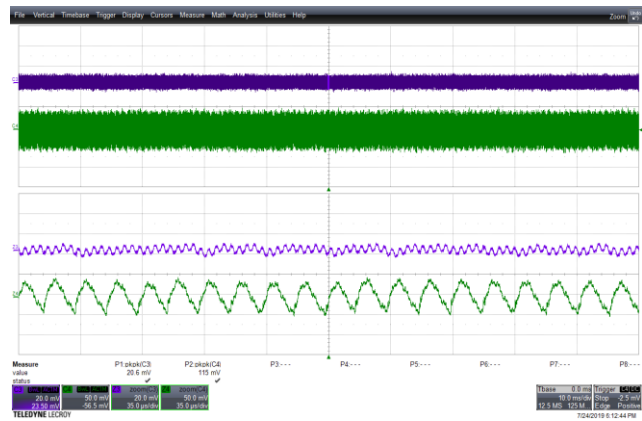

Figure 112 – 265 VAC 50 Hz, Full Load Normal.
 Upper: V_{USB-A} , 50 mV / div., 10 ms / div.
 Lower: V_{USB-C} , 50 mV / div.
 $V_{RIPPLE(USB-A)} = 20.6\text{ mVpp}$.
 $V_{RIPPLE(USB-C)} = 115\text{ mVpp}$.

12.5.3 Output Ripple Voltage at $V_{USB-C} = 12\text{ V} / 2.5\text{ A}$, $V_{USB-A} = 5\text{ V} / 2.4\text{ A}$

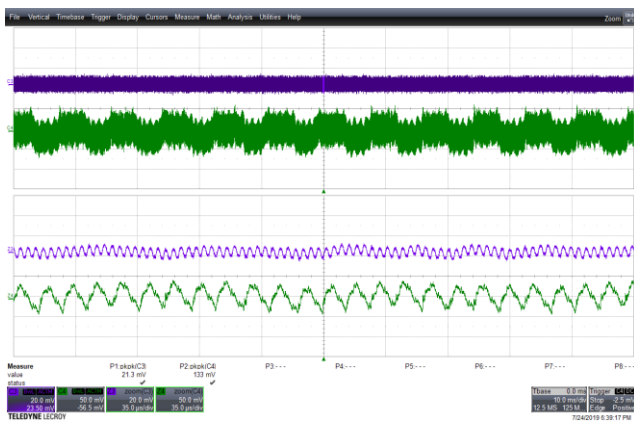

Figure 113 – 90 VAC 60 Hz, Full Load Normal.
 Upper: V_{USB-A} , 50 mV / div., 10 ms / div.
 Lower: V_{USB-C} , 50 mV / div.
 $V_{RIPPLE(USB-A)} = 21.3\text{ mVpp}$.
 $V_{RIPPLE(USB-C)} = 133\text{ mVpp}$.

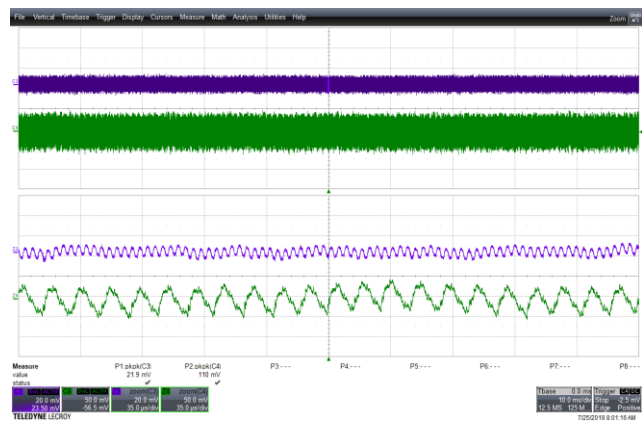

Figure 114 – 265 VAC 50 Hz, Full Load Normal.
 Upper: V_{USB-A} , 50 mV / div., 10 ms / div.
 Lower: V_{USB-C} , 50 mV / div.
 $V_{RIPPLE(USB-A)} = 21.9\text{ mVpp}$.
 $V_{RIPPLE(USB-C)} = 110\text{ mVpp}$.

12.5.4 Output Ripple Voltage at $V_{USB-C} = 20\text{ V} / 1.5\text{ A}$, $V_{USB-A} = 5\text{ V} / 2.4\text{ A}$

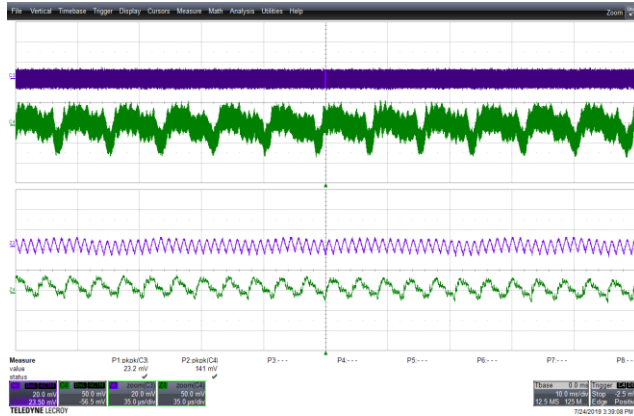

Figure 115 – 90 VAC 60 Hz, Full Load Normal.
 Upper: V_{USB-A} , 50 mV / div., 10 ms/div.
 Lower: V_{USB-C} , 50 mV / div.
 $V_{RIPPLE(USB-A)} = 23.2\text{ mVpp}$.
 $V_{RIPPLE(USB-C)} = 141\text{ mVpp}$.

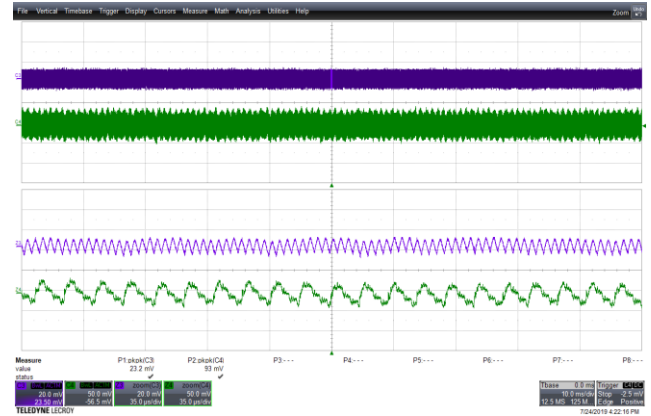

Figure 116 – 265 VAC 50 Hz, Full Load Normal.
 Upper: V_{USB-A} , 50 mV / div., 10 ms / div.
 Lower: V_{USB-C} , 50 mV / div.
 $V_{RIPPLE(USB-A)} = 23.2\text{ mVpp}$.
 $V_{RIPPLE(USB-C)} = 93\text{ mVpp}$.

12.6 **Output Short-Circuit**

12.6.1 USB-C Output Short-Circuit at $V_{USB-C} = 5\text{ V}$, Full Load

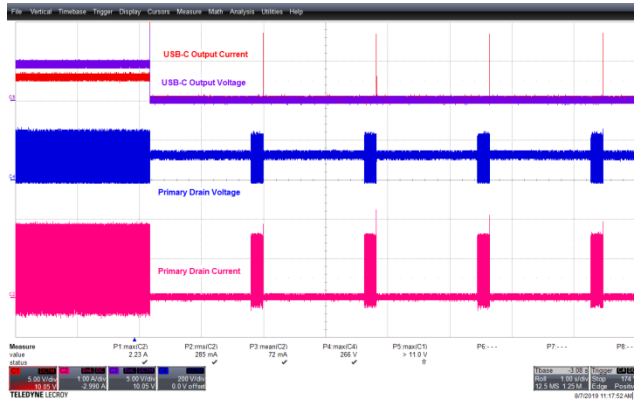

Figure 117 – 90 VAC 60 Hz, USB-C Full Load Short.
 CH1(Red): I_{USB-C} , 5 A / div., 1 s / div.
 CH2(Pink): I_{DRAIN} , 1 A / div.
 CH3(Violet): V_{USB-C} , 5 V / div.
 CH4(Blue): V_{DRAIN} , 200V / div.

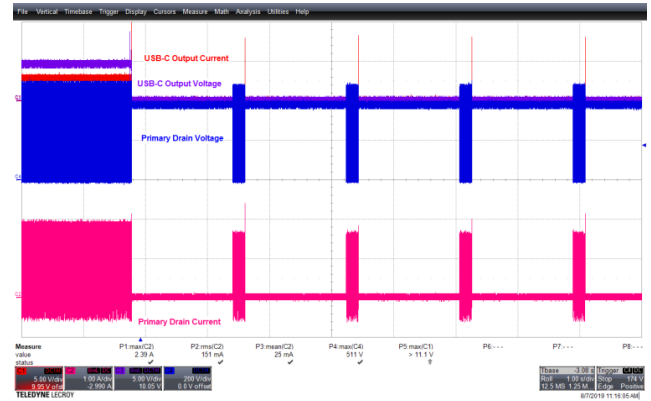

Figure 118 – 265 VAC 50 Hz, USB-C Full Load Short.
 CH1(Red): I_{USB-C} , 5 A / div., 1 s / div.
 CH2(Pink): I_{DRAIN} , 1 A / div.
 CH3(Violet): V_{USB-C} , 5 V / div.
 CH4(Blue): V_{DRAIN} , 200V / div.



12.6.2 USB-C Output Short-Circuit at $V_{USB-C} = 20\text{ V}$, Full Load

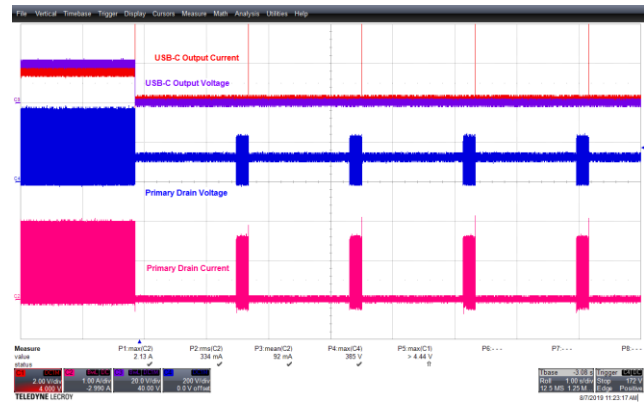
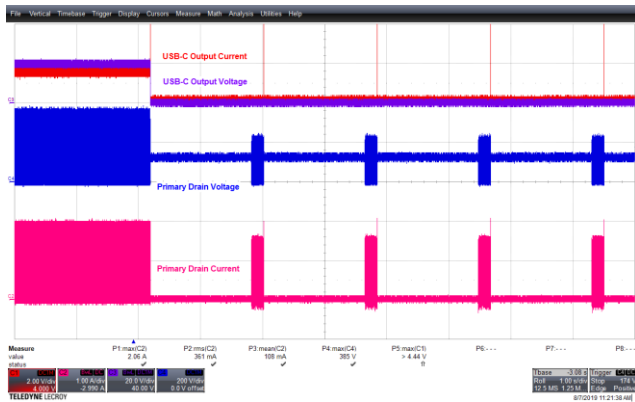

Figure 119 – 90 VAC 60 Hz, USB-C Full Load Short.
 CH1(Red): I_{USB-C} , 2 A / div., 1 s / div
 CH2(Pink): I_{DRAIN} , 1 A / div.
 CH3(Violet): V_{USB-C} , 20 V / div.
 CH4(Blue): V_{DRAIN} , 200 V / div.

Figure 120 – 265 VAC 50 Hz, USB-C Full Load Short.
 CH1(Red): I_{USB-C} , 2 A / div., 1 s / div.
 CH2(Pink): I_{DRAIN} , 1 A / div.
 CH3(Violet): V_{USB-C} , 20 V / div.
 CH4(Blue): V_{DRAIN} , 200 V / div.

12.6.3 Start-up with USB-C Output Shorted

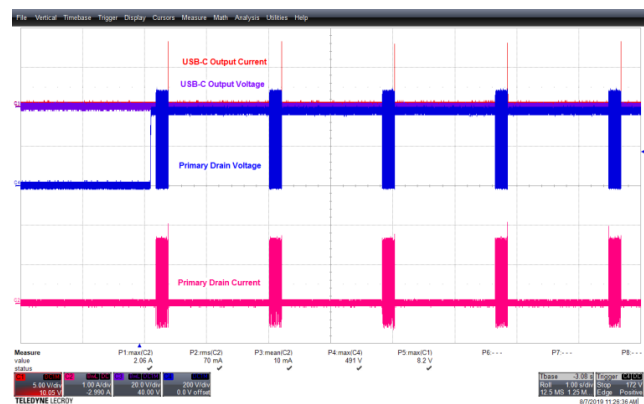
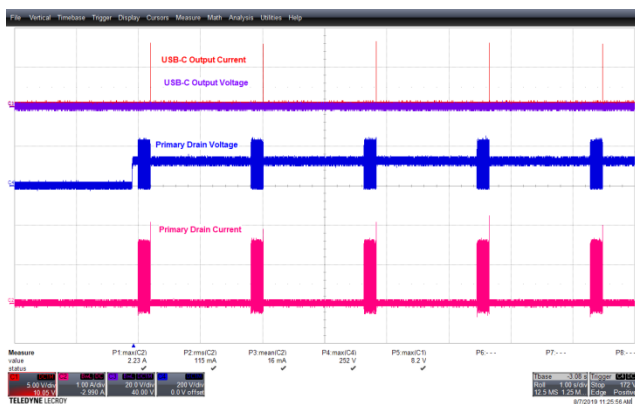

Figure 121 – 90 VAC 60 Hz, USB-C Full Load Short.
 CH1(Red): I_{USB-C} , 5 A / div., 1 s / div.
 CH2(Pink): I_{DRAIN} , 1 A / div.
 CH3(Violet): V_{USB-C} , 20 V / div.
 CH4(Blue): V_{DRAIN} , 200 V / div.

Figure 122 – 265 VAC 50 Hz, USB-C Full Load Short.
 CH1(Red): I_{USB-C} , 5 A / div., 1 s / div.
 CH2(Pink): I_{DRAIN} , 1 A / div.
 CH3(Violet): V_{USB-C} , 20 V / div.
 CH4(Blue): V_{DRAIN} , 200 V / div.

12.6.4 Start-up with USB-A Output Shorted

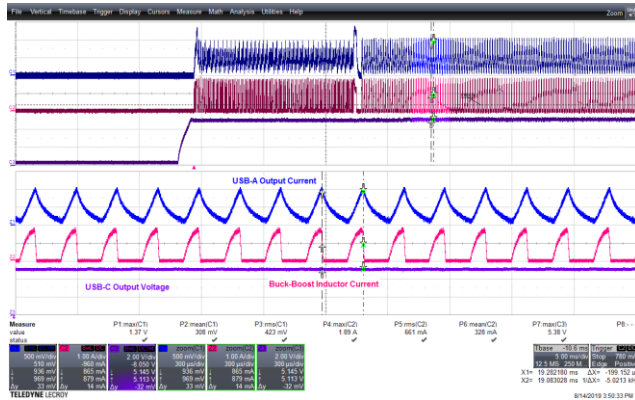

Figure 123 – 90 VAC 60 Hz, USB-A Start-up Short.
 CH1(Blue): I_{USB-A} , 0.5 A / div., 5 ms / div.
 CH2(Pink): I_{L3} , 1 A / div.
 CH3(Violet): V_{USB-C} , 2 V / div.

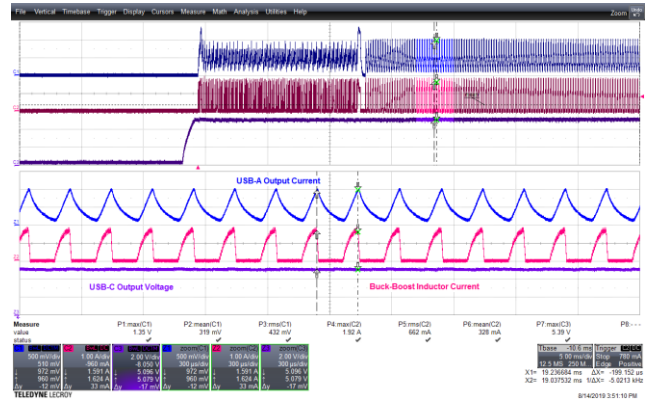

Figure 124 – 265 VAC 60 Hz, USB-A Start-up Short.
 CH1(Blue): I_{USB-A} , 0.5 A / div., 5 ms / div.
 CH2(Pink): I_{L3} , 1 A / div.
 CH3(Violet): V_{USB-C} , 2 V / div.

12.6.5 USB-A Full Load Short at $V_{USB-C} = 5 V$

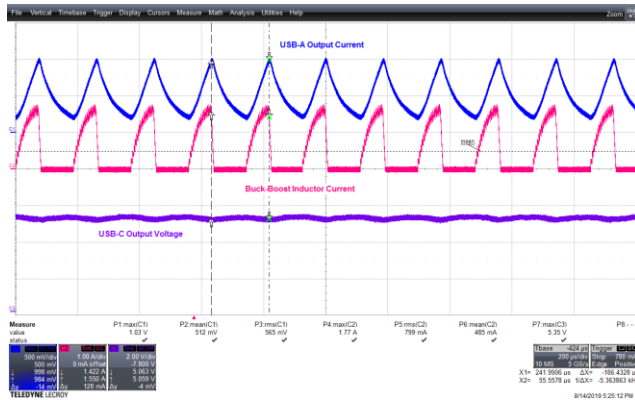

Figure 125 – 90 VAC 60 Hz, USB-A Full Load Short.
 CH1(Blue): I_{USB-A} , 0.5 A / div., 5 ms / div.
 CH2(Pink): I_{L3} , 1 A / div.
 CH3(Violet): V_{USB-C} , 2 V / div.

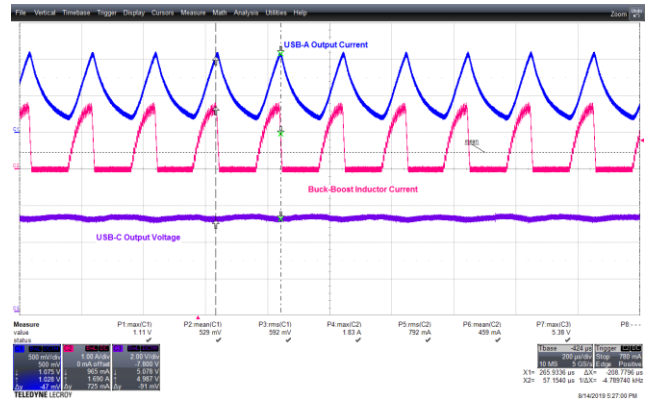

Figure 126 – 265 VAC 60 Hz, USB-A Full Load Short.
 CH1(Blue): I_{USB-A} , 0.5 A / div., 5 ms / div.
 CH2(Pink): I_{L3} , 1 A / div.
 CH3(Violet): V_{USB-C} , 2 V / div.



12.6.6 USB-A Full Load Short at $V_{USB-C} = 20\text{ V}$

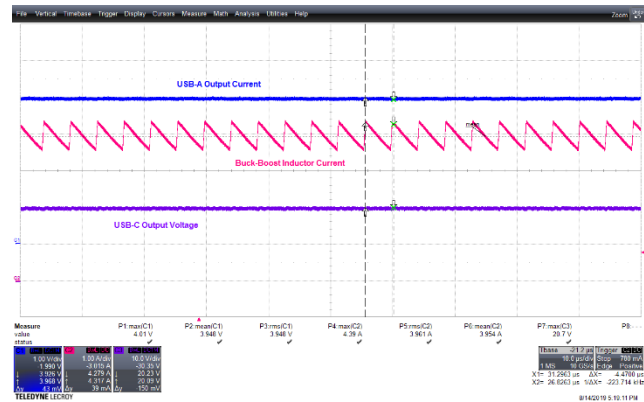
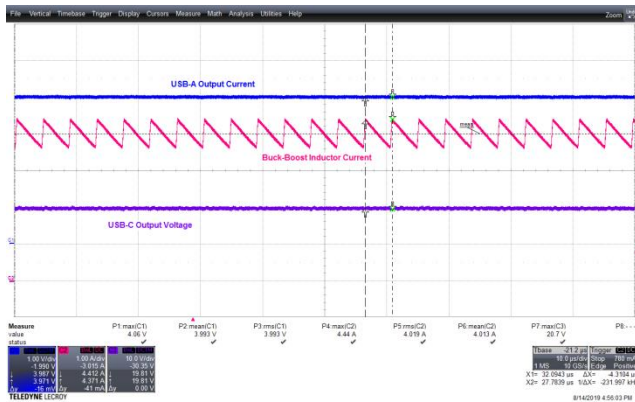

Figure 127 – 90 VAC 60 Hz, USB-A Full Load Short
 CH1(Blue): I_{USB-A} , 1 A / div., 10 μs / div.
 CH2(Pink): I_{L3} , 1 A / div.
 CH3(Violet): V_{USB-C} , 10 V / div.

Figure 128 – 265 VAC 60 Hz, USB-A Full Load Short.
 CH1(Blue): I_{USB-A} , 1 A / div., 10 μs / div.
 CH2(Pink): I_{L3} , 1 A / div.
 CH3(Violet): V_{USB-C} , 10 V / div.

12.7 **Drain Voltage and Current Waveforms at $V_{USB-C} = 20\text{ V}$**

Tested with both USB-A / USB-C in full load condition.

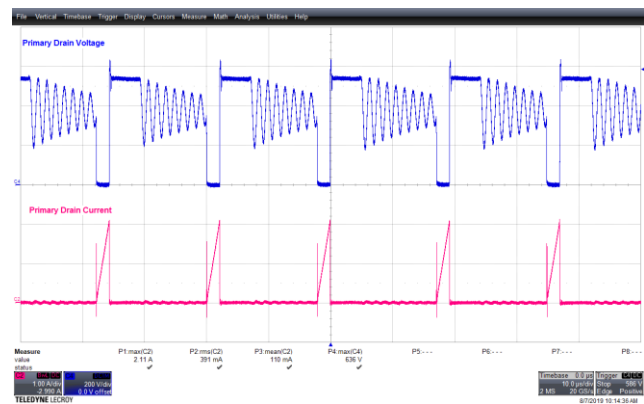
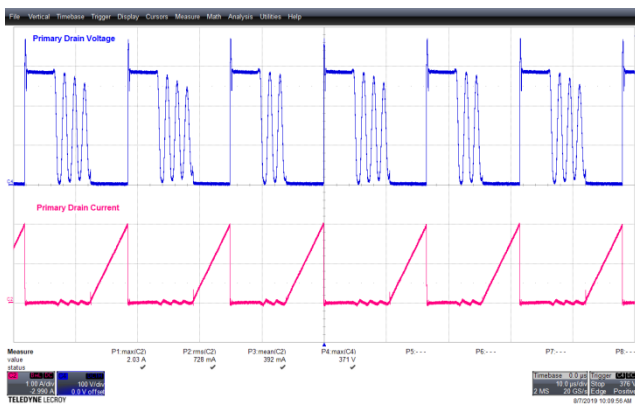

Figure 129 – 90 VAC 60 Hz, $V_{USB-C} = 20\text{ V}$ Full Load.
 Upper: V_{DRAIN} , 1 A / div.
 Lower: I_{DRAIN} , 100 V / div., 10 μs / div.
 $I_{DS} = 2.03\text{ A}$, $V_{DS} = 371\text{ V}$.

Figure 130 – 265 VAC 50 Hz, $V_{USB-C} = 20\text{ V}$ Full Load.
 Upper: V_{DRAIN} , 1 A / div.
 Lower: I_{DRAIN} , 200 V / div., 10 μs / div.
 $I_{DS} = 2.11\text{ A}$, $V_{DS} = 636\text{ V}$.

12.8 Drain Voltage and Current Waveforms at $V_{USB-C} = 5 V$

Tested with both USB-A / USB-C in full load condition.

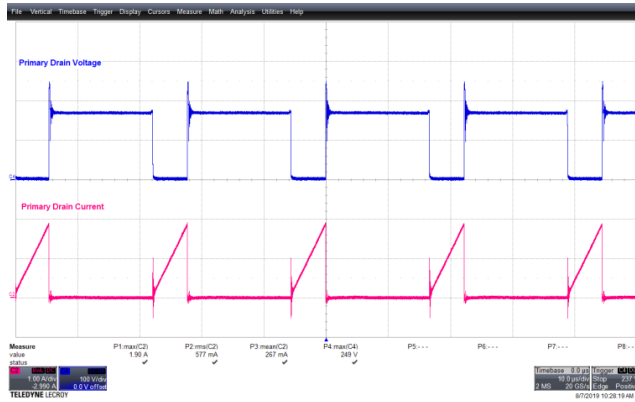

Figure 131 – 90 VAC 60 Hz, $V_{USB-C} = 5 V$ Full Load.
 Upper: V_{DRAIN} , 1 A / div.
 Lower: I_{DRAIN} , 100 V / div., 10 μs / div.
 $I_{DS} = 1.9 A$, $V_{DS} = 249 V$.

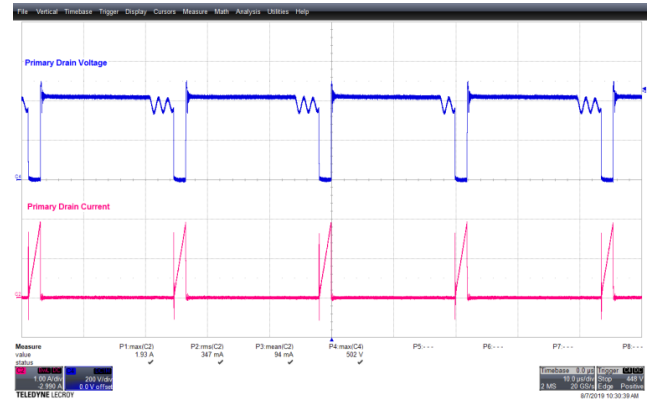

Figure 132 – 265 VAC 50 Hz, $V_{USB-C} = 5 V$ Full Load.
 Upper: V_{DRAIN} , 1 A / div.
 Lower: I_{DRAIN} , 200 V / div., 10 μs / div.
 $I_{DS} = 1.93 A$, $V_{DS} = 502 V$.

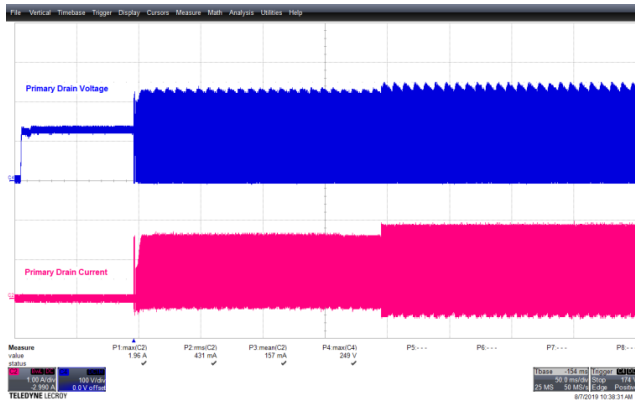

Figure 133 – 90 VAC 60 Hz, $V_{USB-C} = 5 V$ Full Start-up.
 Upper: V_{DRAIN} , 1 A / div.
 Lower: I_{DRAIN} , 100 V / div., 10 μs / div.
 $I_{DS} = 1.96 A$, $V_{DS} = 249 V$.

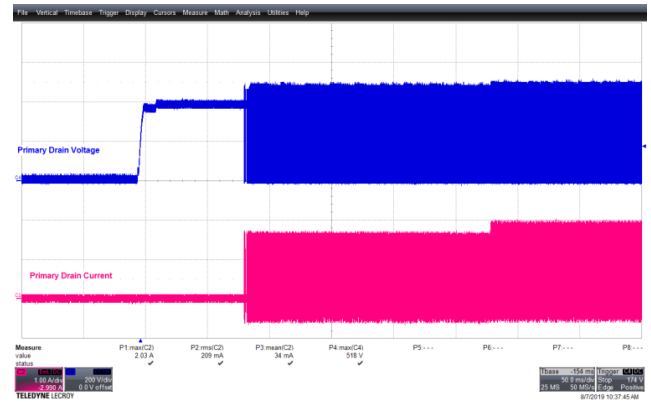

Figure 134 – 265 VAC 50 Hz, $V_{USB-C} = 5 V$ Full Start-up.
 Upper: V_{DRAIN} , 1 A / div.
 Lower: I_{DRAIN} , 200 V / div., 10 μs / div.
 $I_{DS} = 1.93 A$, $V_{DS} = 518 V$.

12.9 SR FET Drain Voltage

Tested with both USB-A / USB-C in full load condition.

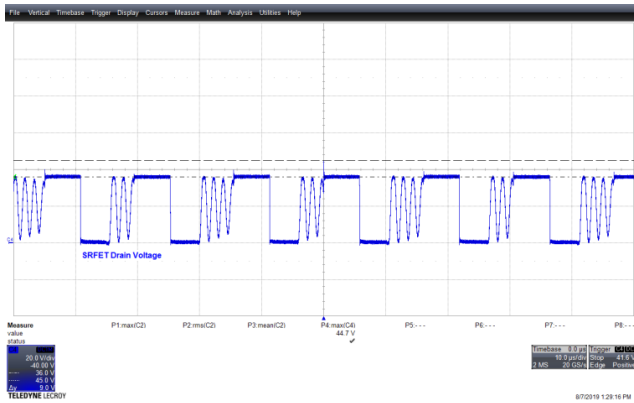

Figure 135 – 90 VAC 60 Hz, $V_{USB-C} = 20$ V Full Normal.
 V_{DRAIN} , 20 V / div., 10 μ s / div.
 $V_{DS} = 45$ V.

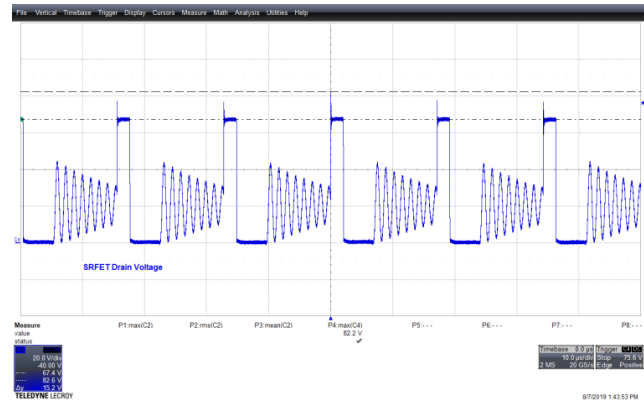

Figure 136 – 265 VAC 50 Hz, $V_{USB-C} = 20$ V Full Normal.
 V_{DRAIN} , 20 V / div., 10 μ s / div.
 $V_{DS} = 82.2$ V.

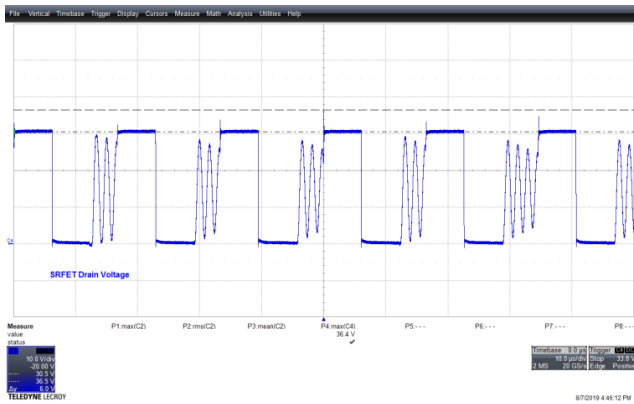

Figure 137 – 90 VAC 60 Hz, $V_{USB-C} = 15$ V Full Normal.
 V_{DRAIN} , 20 V / div., 10 μ s / div.
 $V_{DS} = 36.4$ V.

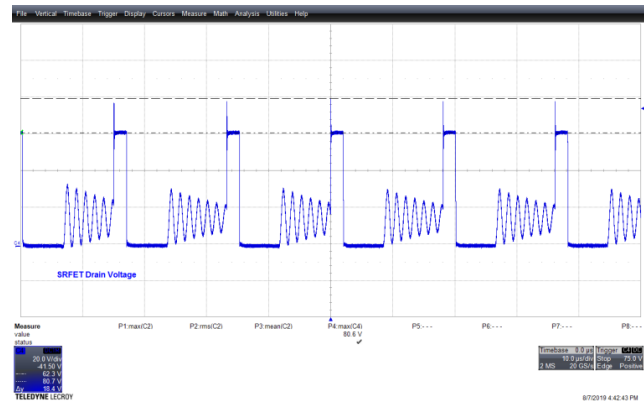

Figure 138 – 265 VAC 50 Hz, $V_{USB-C} = 15$ V Full Normal.
 V_{DRAIN} , 20 V / div., 10 μ s / div.
 $V_{DS} = 80.6$ V.

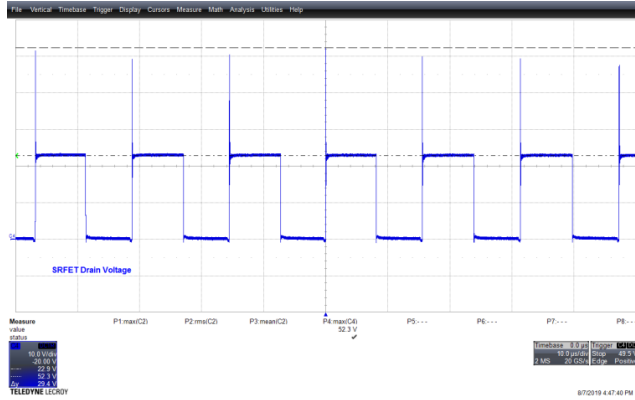

Figure 139 – 90 VAC 60 Hz, $V_{USB-C} = 12\text{ V}$ Full Normal.
 V_{DRAIN} , 20 V / div., 10 μs / div.
 $V_{DS} = 52.3\text{ V}$.

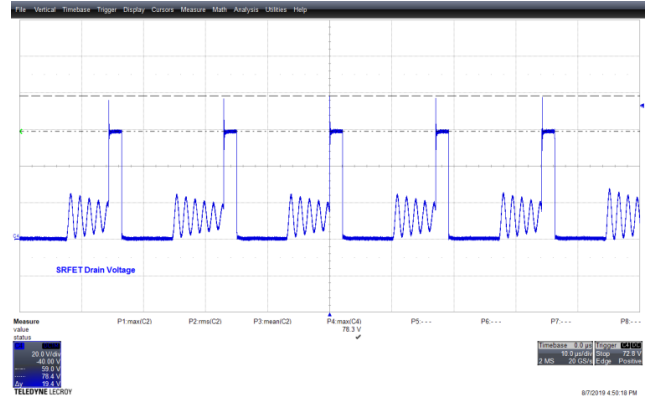

Figure 140 – 265 VAC 50 Hz, $V_{USB-C} = 12\text{ V}$ Full Normal.
 V_{DRAIN} , 20 V / div., 10 μs / div.
 $V_{DS} = 78.3\text{ V}$.

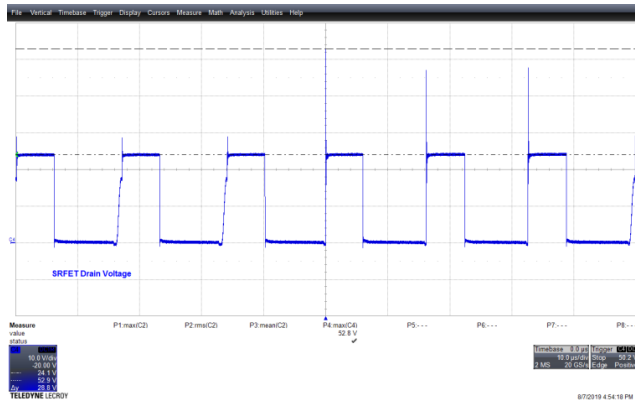

Figure 141 – 90 VAC 60 Hz, $V_{USB-C} = 9\text{ V}$ Full Normal.
 V_{DRAIN} , 20 V / div., 10 μs / div.
 $V_{DS} = 52.8\text{ V}$.

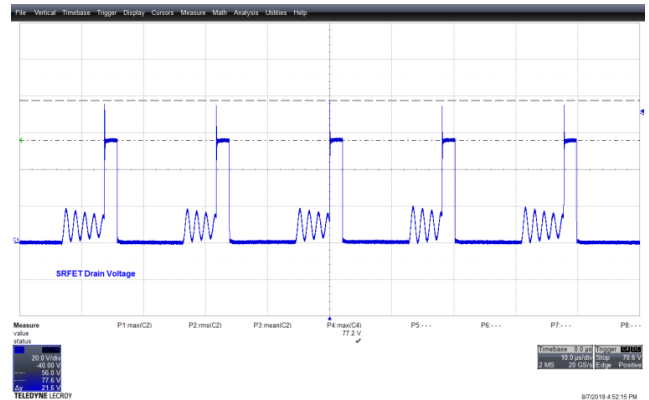

Figure 142 – 265 VAC 50 Hz, $V_{USB-C} = 9\text{ V}$ Full Normal.
 V_{DRAIN} , 20 V / div., 10 μs / div.
 $V_{DS} = 77.2\text{ V}$.

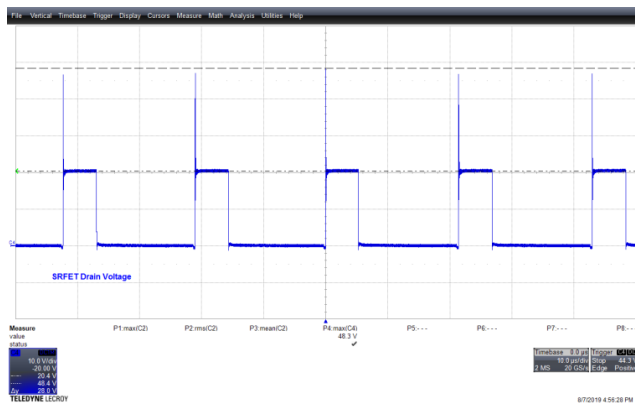

Figure 143 – 90 VAC 60 Hz, $V_{USB-C} = 9\text{ V}$ Full Normal.
 V_{DRAIN} , 20 V / div., 10 μs / div.
 $V_{DS} = 48.3\text{ V}$.

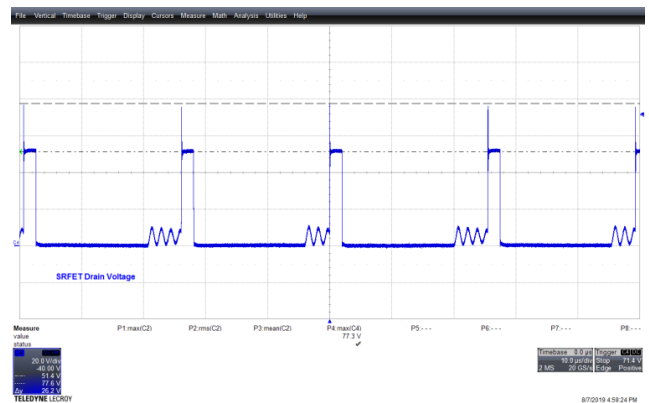

Figure 144 – 265 VAC 50 Hz, $V_{USB-C} = 9\text{ V}$ Full Normal.
 V_{DRAIN} , 20 V / div., 10 μs / div.
 $V_{DS} = 77.3\text{ V}$.



13 Conducted EMI

13.1 *Test Set-up*

EMI measurement was done using a resistor load for both Type-C and Type-A output receptacle.

13.2 *Equipment and Load Used*

1. Rohde and Schwarz ENV216 two line V-network.
2. Rohde and Schwarz ESRP EMI test receiver.
3. Chroma measurement test fixture.
4. Full Load with input voltage set at 230 VAC 50 Hz and 115 VAC.

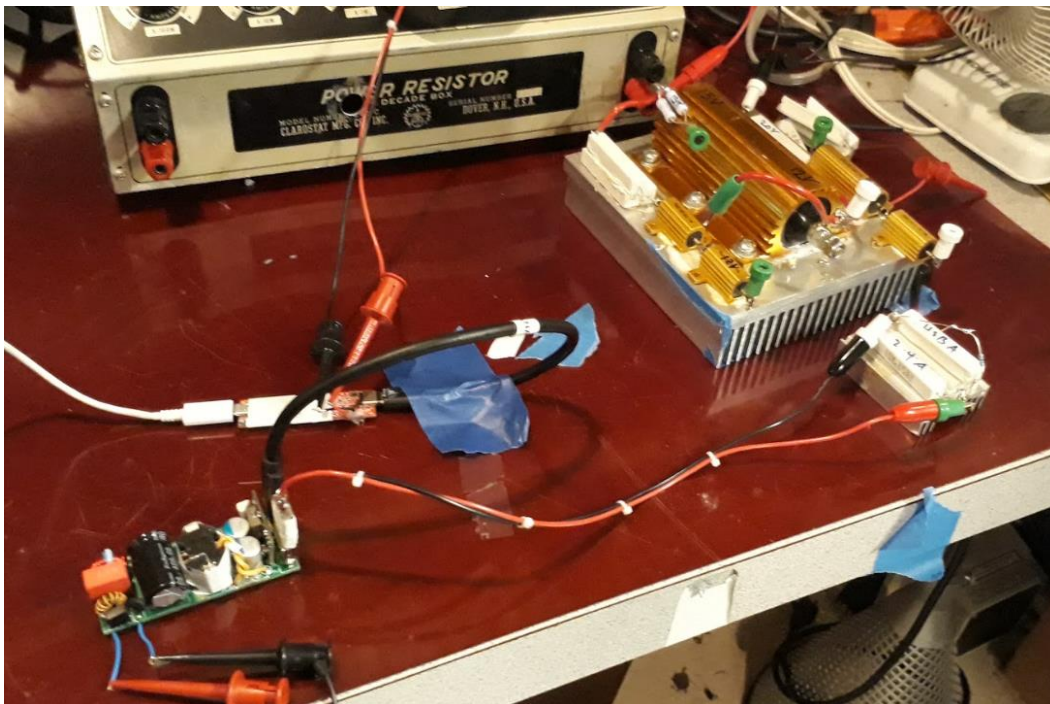

Figure 145 – Conducted EMI Test Set-up.

13.3 **Conducted EMI at $V_{USB-C} = 20\text{ V}$ Full Load with Output Floating**

Tested with USB Type-C loaded with 13.33Ω ($20\text{ V} / 1.5\text{ A}$) while USB Type-A was loaded with 2.08Ω ($5\text{ V} / 2.4\text{ A}$) load resistor.

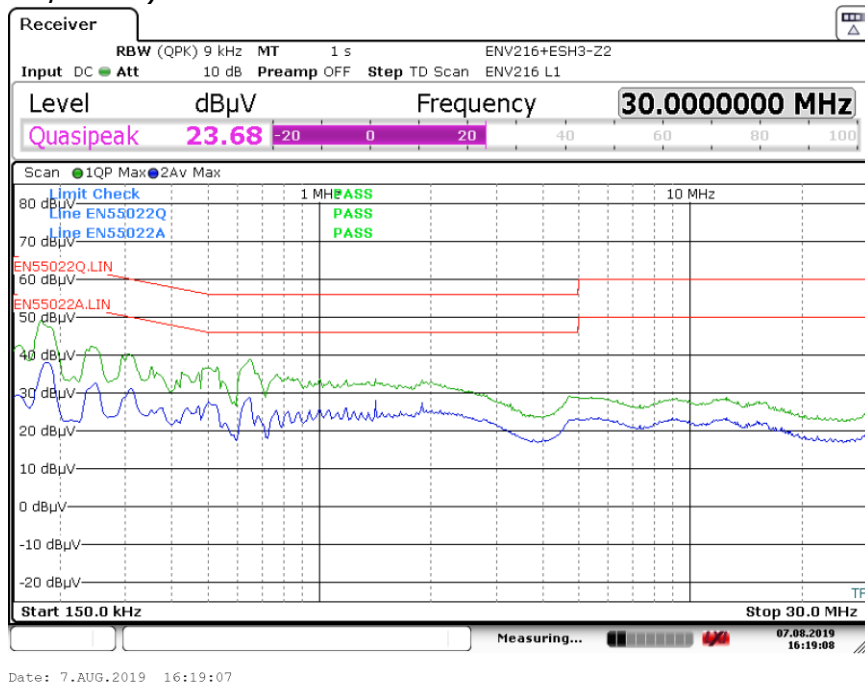

Figure 146 – Conducted EMI at $V_{USB-C}=20\text{ V}$ Full Load, 115 VAC 60 Hz Line L.

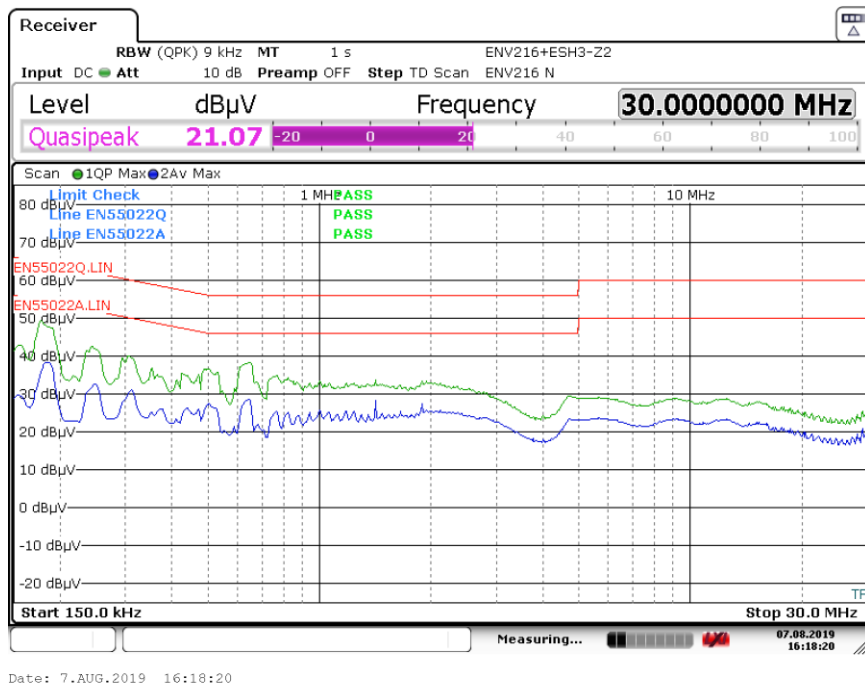

Figure 147 – Conducted EMI at $V_{USB-C}=20\text{ V}$ Full Load, 115 VAC 60 Hz Line N.

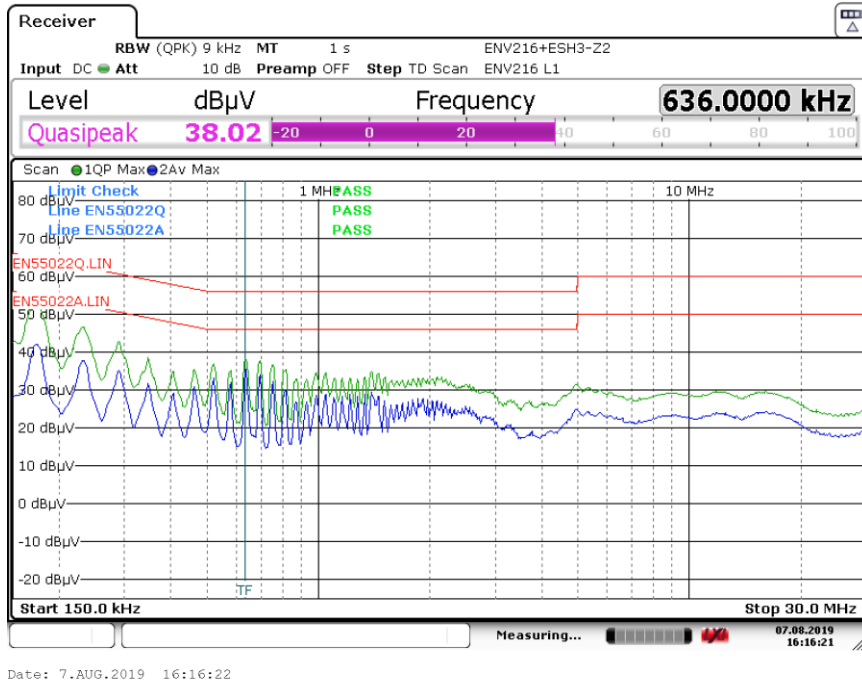

Figure 148 – Conducted EMI at $V_{USB-C}=20$ V Full Load, 230 VAC 50 Hz Line L.

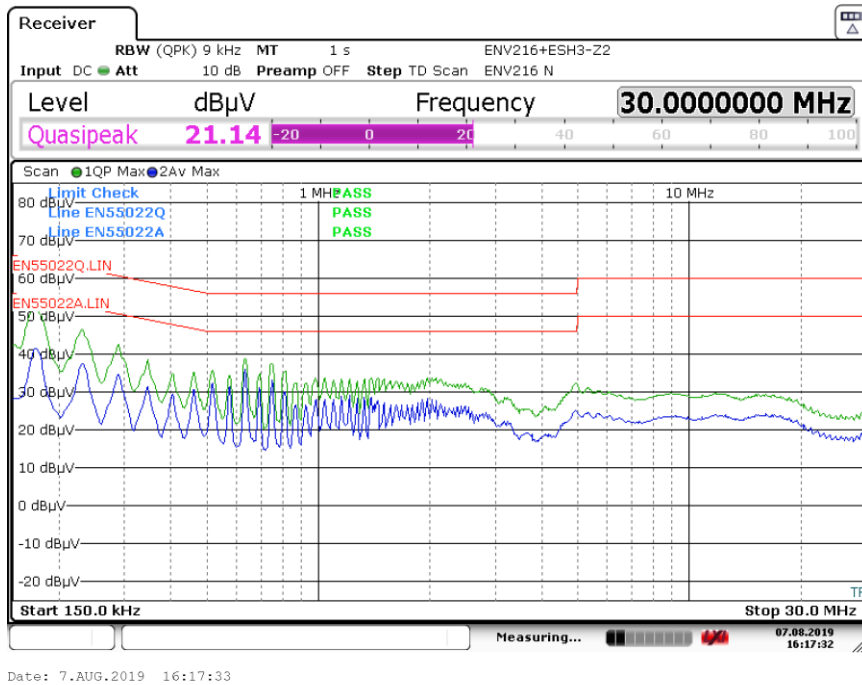

Figure 149 – Conducted EMI at $V_{USB-C}=20$ V Full Load, 230 VAC 50 Hz Line N.

13.4 **Conducted EMI at $V_{USB-C} = 12\text{ V}$ Full Load with Output Floating**

Tested with USB Type-C loaded with $4.8\ \Omega$ ($12\text{ V} / 2.5\text{ A}$) while USB Type-A was loaded with $2.08\ \Omega$ ($5\text{ V} / 2.4\text{ A}$) load resistor.

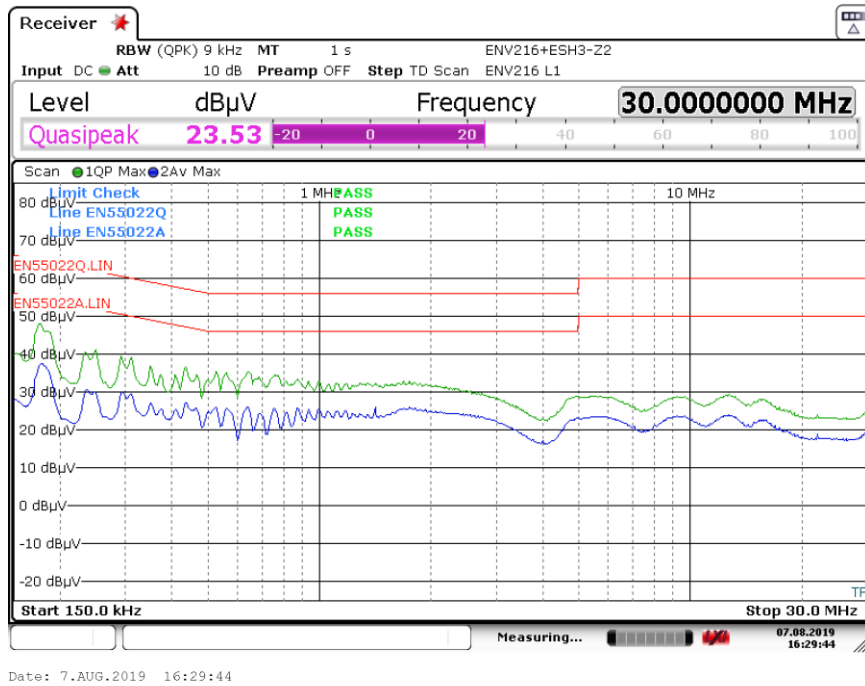

Figure 150 – Conducted EMI at $V_{USB-C}=12\text{ V}$ Full Load, 115 VAC 60 Hz Line L.

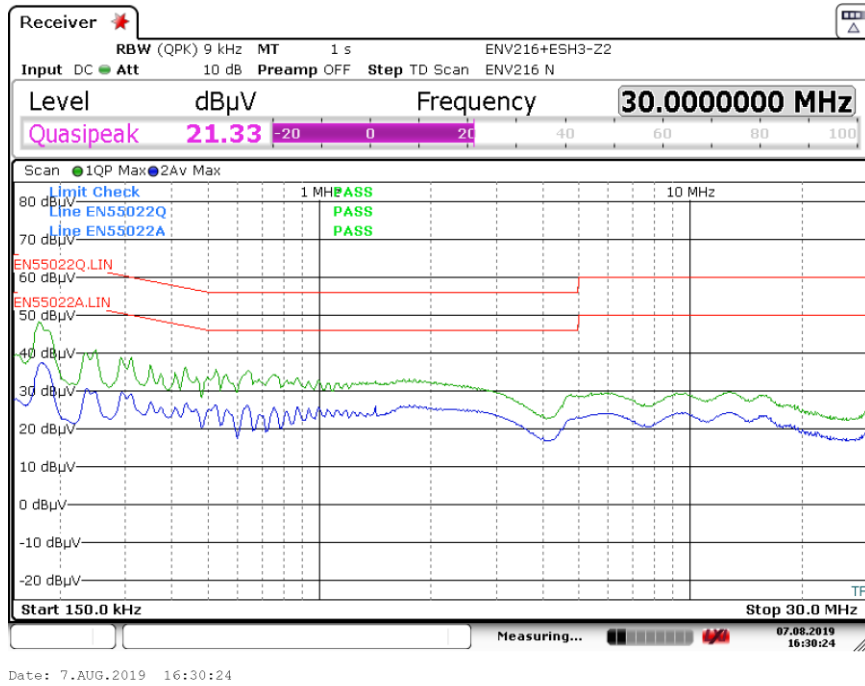

Figure 151 – Conducted EMI at $V_{USB-C}=12\text{ V}$ Full Load, 115 VAC 60 Hz Line N.



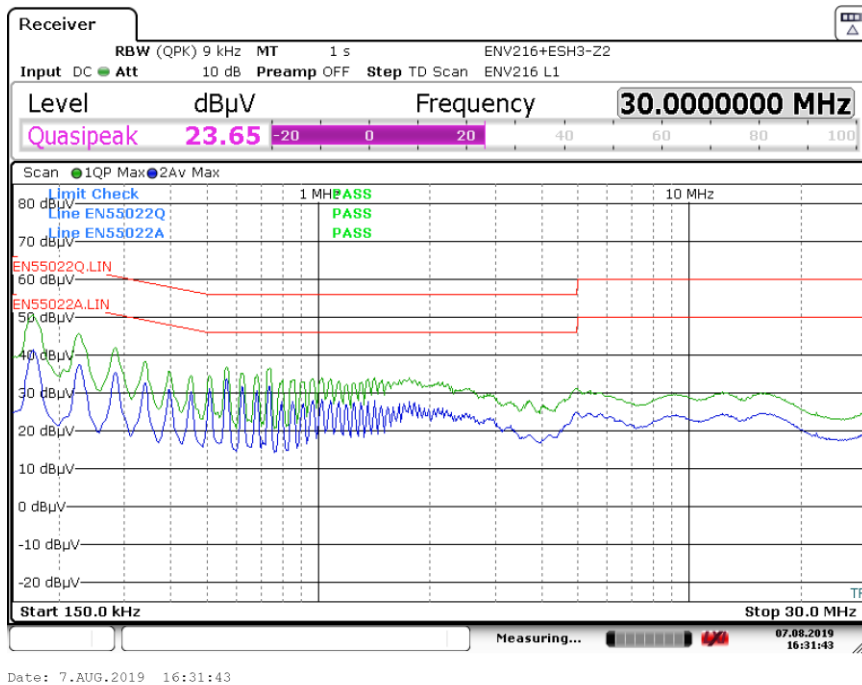

Figure 152 – Conducted EMI at $V_{USB-C}=12$ V Full Load, 230 VAC 50 Hz Line L.

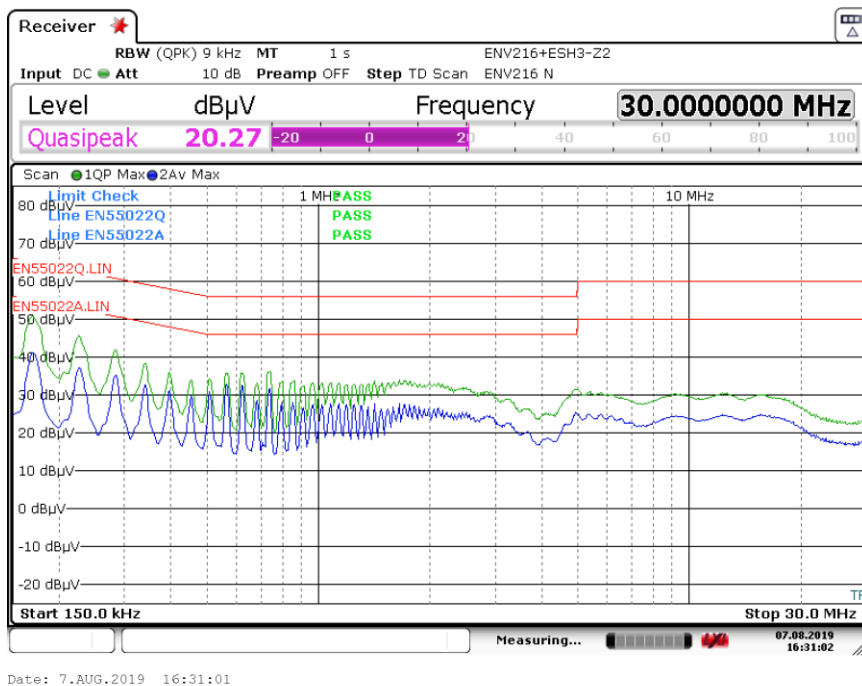

Figure 153 – Conducted EMI at $V_{USB-C}=12$ V Full Load, 230 VAC 50 Hz Line N.

13.5 **Conducted EMI at $V_{USB-C} = 5$ V Full Load with Output Floating**

Tested with USB Type-C loaded with 1.67Ω (5 V / 3 A) while USB Type-A was loaded with 2.08Ω (5 V / 2.4 A) load resistor.

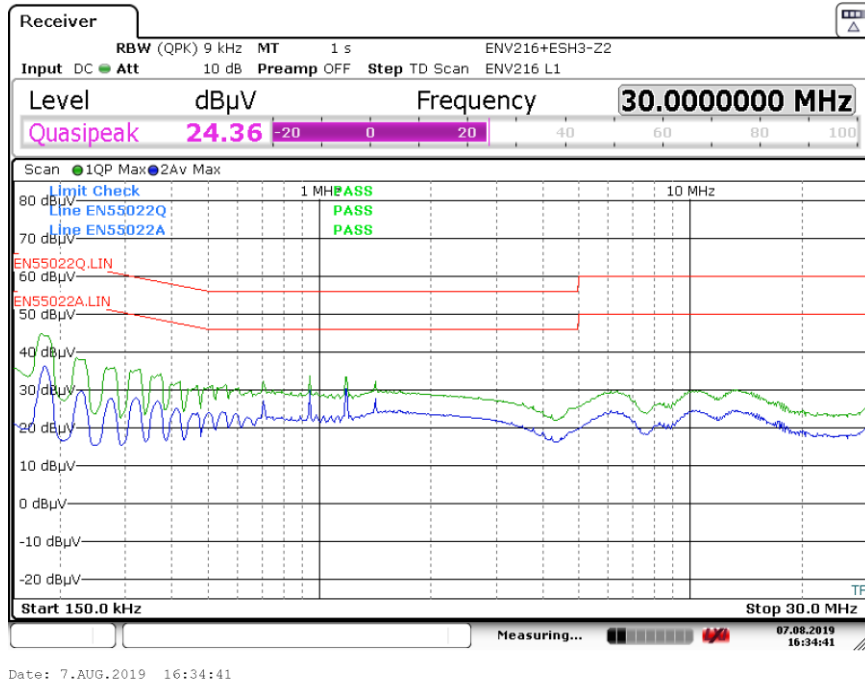

Figure 154 – Conducted EMI at $V_{USB-C}=5$ V Full Load, 115 VAC 60 Hz Line L.

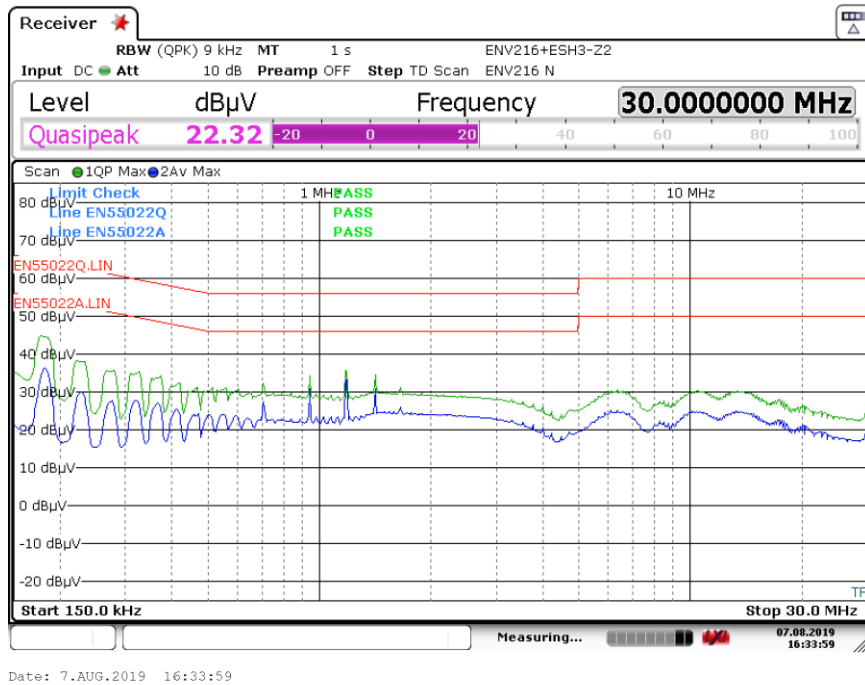

Figure 155 – Conducted EMI at $V_{USB-C}=5$ V Full Load, 115 VAC 60 Hz Line N.



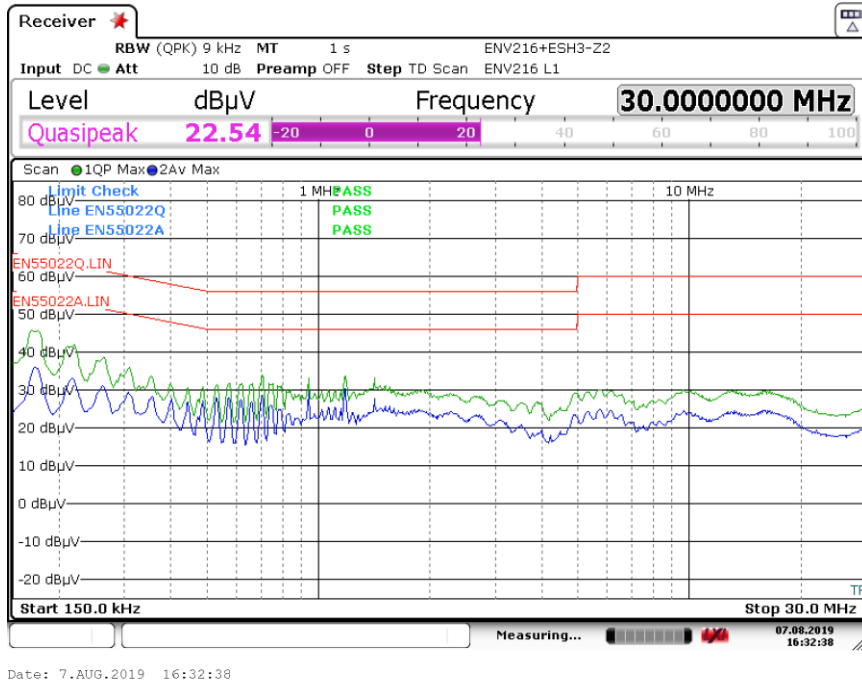

Figure 156 – Conducted EMI at $V_{USB-C}=5$ V Full Load, 230 VAC 50 Hz Line L.

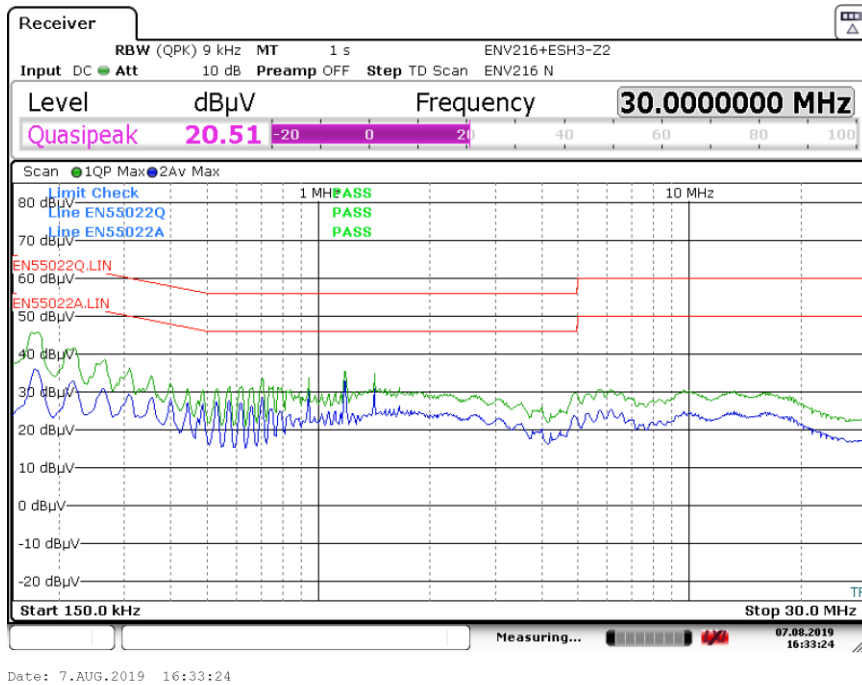

Figure 157 – Conducted EMI at $V_{USB-C}=5$ V Full Load, 230 VAC 50 Hz Line N.

13.6 **Conducted EMI at $V_{USB-C} = 20\text{ V}$ Full Load, Earth Grounded**

Tested with USB Type-C loaded with $13.33\ \Omega$ ($20\text{ V} / 1.5\text{ A}$) while USB Type-A was loaded with $2.08\ \Omega$ ($5\text{ V} / 2.4\text{ A}$) load resistor.

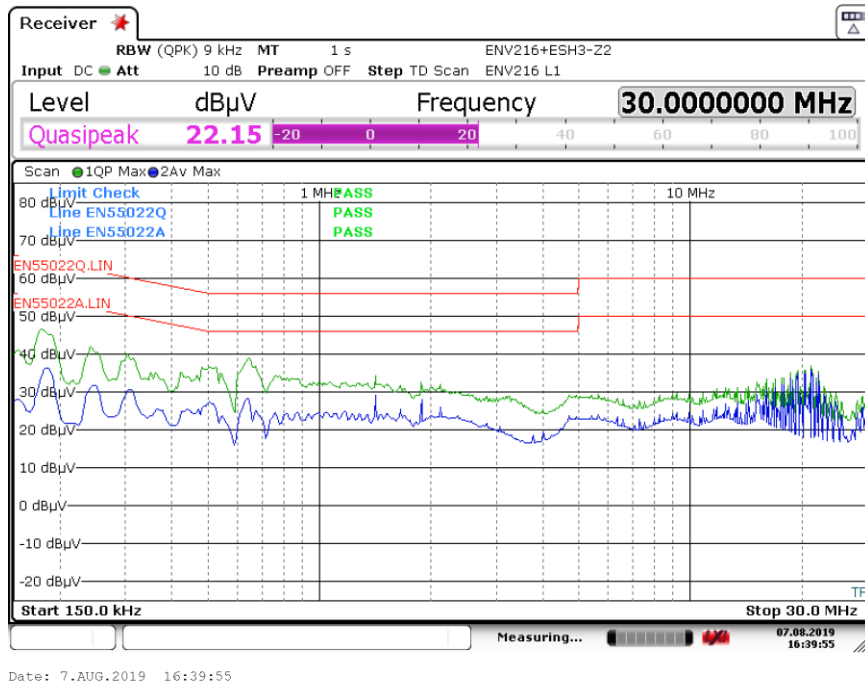

Figure 158 – Conducted EMI at $V_{USB-C}=20\text{ V}$ Full Load, 115 VAC 60 Hz Line L. Output Grounded.

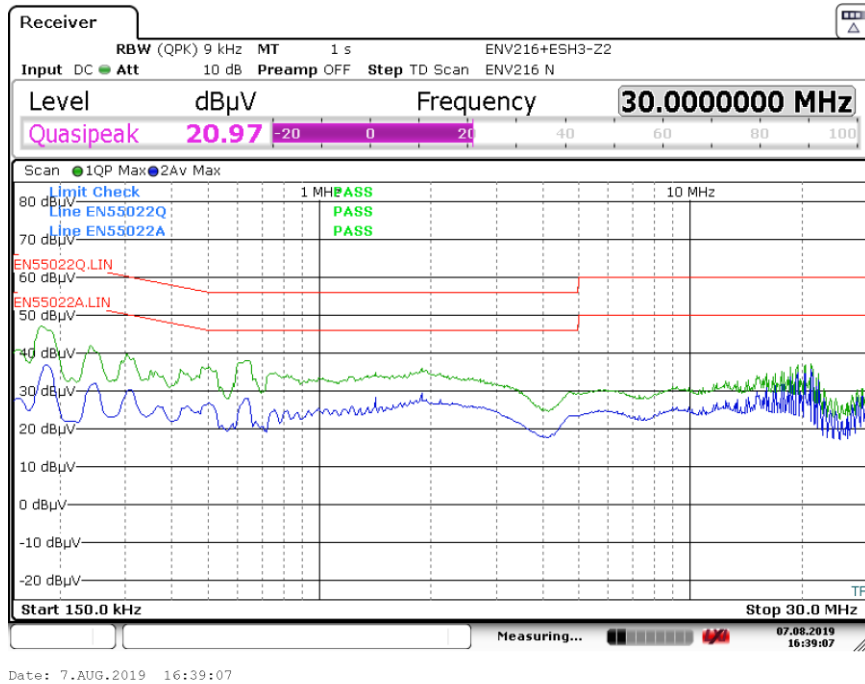

Figure 159 – Conducted EMI at $V_{USB-C}=20\text{ V}$ Full Load, 115 VAC 60 Hz Line N. Output Grounded.



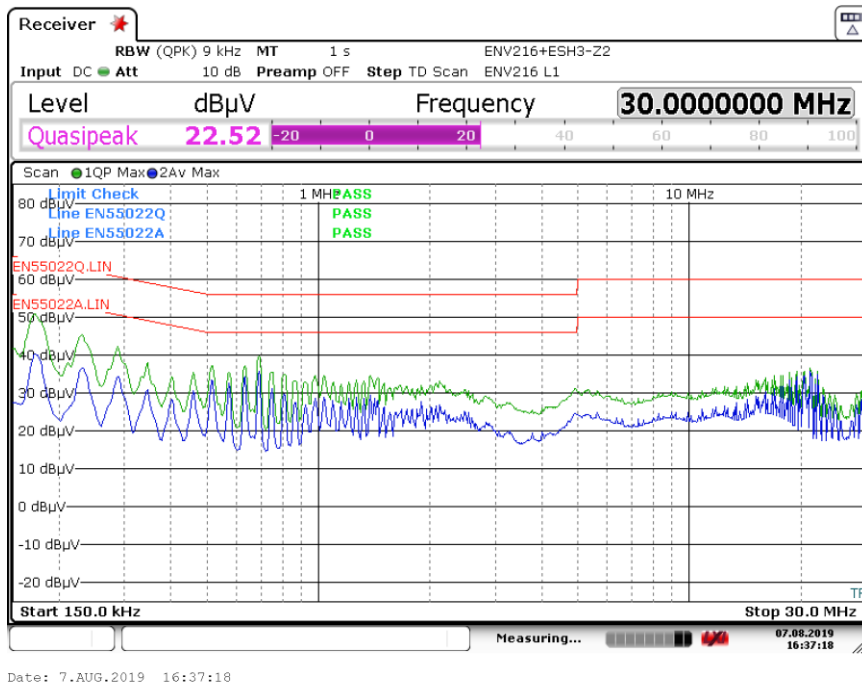

Figure 160 – Conducted EMI at $V_{USB-C}=20$ V Full Load, 230 VAC 50 Hz Line L. Output Grounded.

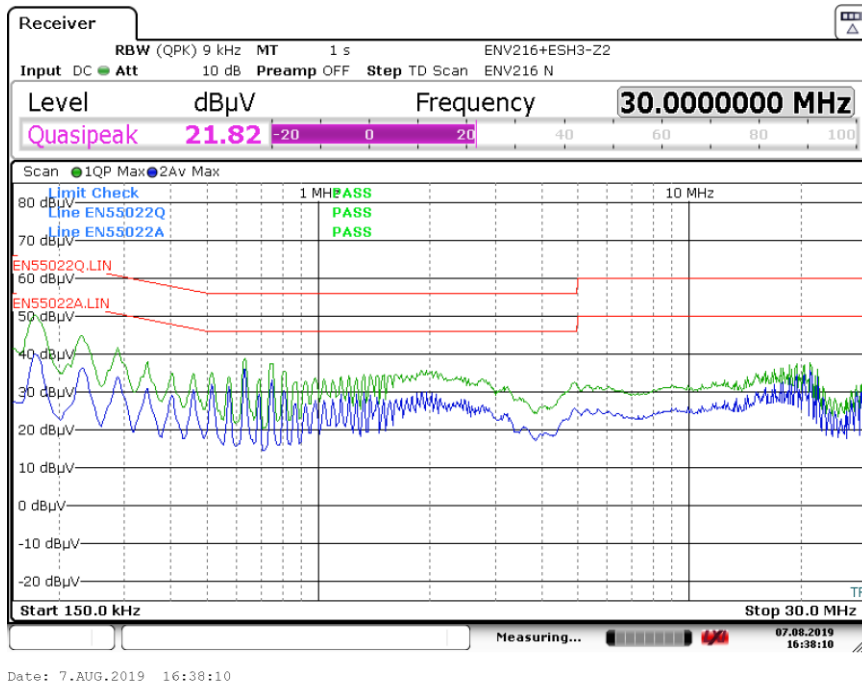

Figure 161 – Conducted EMI at $V_{USB-C}=20$ V Full Load, 230 VAC 50 Hz Line N. Output Grounded.

14 Line Immunity

Unit with USB-C Load of 20 V / 1.5 A and USB-A load of 5 V / 2.4 A was subjected to ring wave and combination wave surge immunity. A test failure was defined as a non-recoverable interruption of output requiring repair or recycling of input voltage.

Loading Set-up:

USB-C: 20 V / 1.5 A (13.33 Ω Resistor Loads)

USB-A: 5 V / 2.4 A (2.08 Ω Resistor Loads)

14.1 Differential Surge Test Results

Source Impedance: 2 Ω

Repetition Rate: 1/30 s

No. of surge strike per location: 10 strikes

Differential Surge	Input Voltage (VAC)	Injection Location	Injection Phase ($^{\circ}$)	Test Result (Pass/Fail)
2000	230	L to N	0	Pass
-2000	230	L to N	0	Pass
2000	230	L to N	90	Pass
-2000	230	L to N	90	Pass
2000	230	L to N	270	Pass
-2000	230	L to N	270	Pass

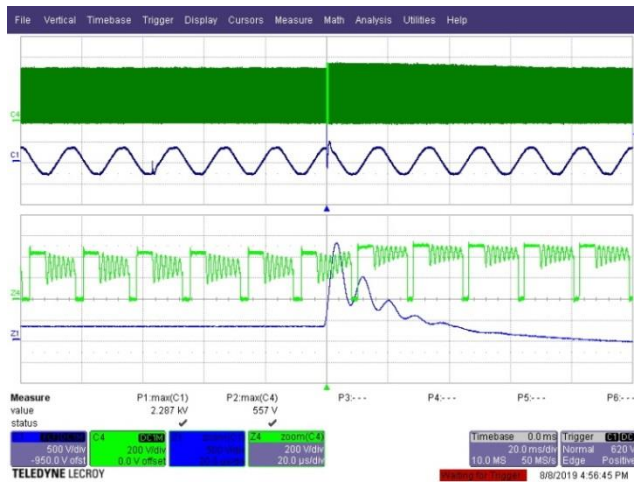

Figure 162 – 230 VAC 50 Hz, 2 kV Differential Surge

L/N.

Injection Phase: 90 $^{\circ}$.

Upper: V_{DRAIN} , 200 V / div.

Lower: V_{IN} , 500 V / div., 20 ms / div.

V_{DS} = 557 V.

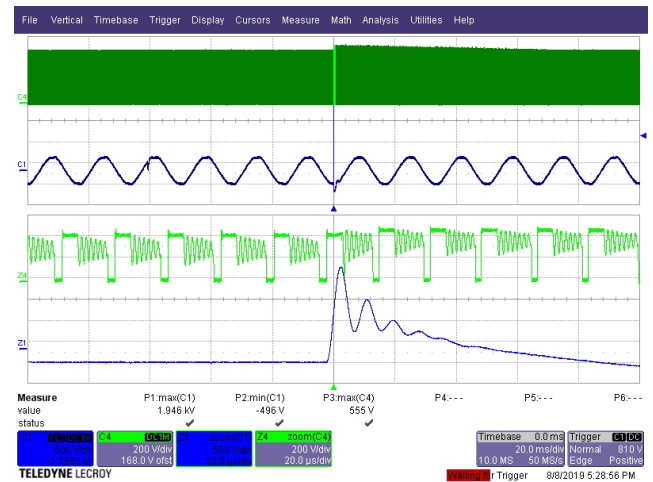

Figure 163 – 230 VAC 50 Hz, 2 kV Differential Surge

L/N.

Injection Phase: 270 $^{\circ}$.

Upper: V_{DRAIN} , 200 V / div.

Lower: V_{IN} , 500 V / div., 20 ms / div.

V_{DS} = 555 V.

14.2 Ring Wave Surge Test Results

Source Impedance: 12Ω

Repetition Rate: 1/30 s

No. of surge strike per location: 10 strikes

Differential Surge	Input Voltage (VAC)	Injection Location	Injection Phase (°)	Test Result (Pass/Fail)
2500	230	L to N	0	Pass
-2500	230	L to N	0	Pass
2500	230	L to N	90	Pass
-2500	230	L to N	90	Pass
2500	230	L to N	270	Pass
-2500	230	L to N	270	Pass

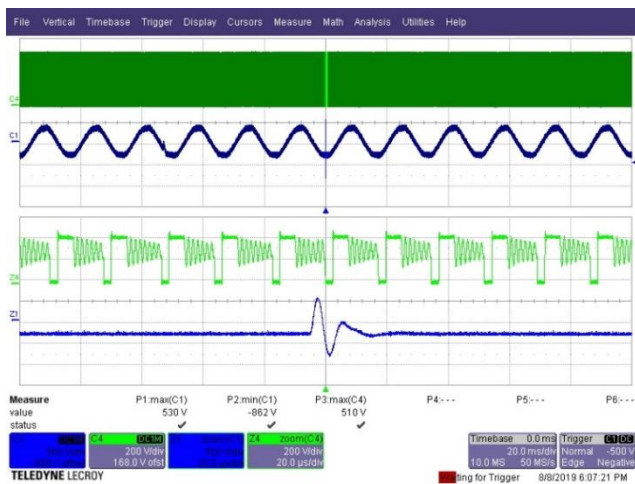

Figure 164 – 230 VAC 50 Hz, 2.5kV Ring Wave L/N.
 Injection Phase: 90°
 Upper: V_{DRAIN}, 200 V / div.
 Lower: V_{IN}, 500 V / div., 20 ms / div.
 VDS = 510 V.

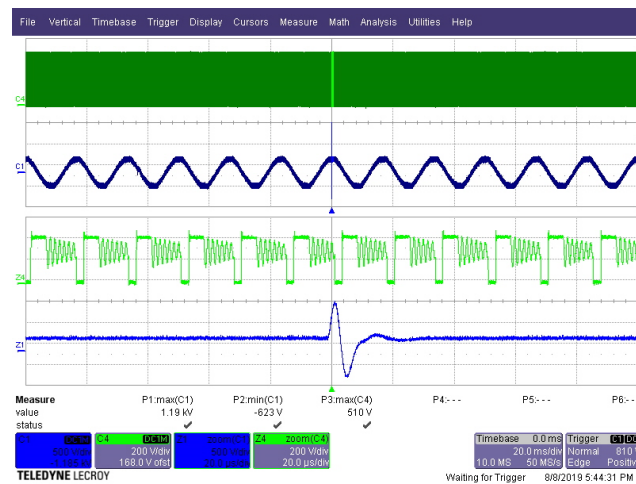

Figure 165 – 230 VAC 50 Hz, 2.5kV Ring Wave L/N.
 Injection Phase: 270°
 Upper: V_{DRAIN}, 200 V / div.
 Lower: V_{IN}, 500 V / div., 20 ms / div.
 VDS = 510 V.

15 ESD

Unit was subjected to ± 8 kV, ± 12 kV and ± 15 kV ESD air discharge test. An LED indicator connected across the resistor load was used to observe the output behavior during to ESD. A test failure was defined as a non-recoverable interruption of output requiring repair or recycling of input voltage.

Loading Set-up:

USB-C: 5 V / 3.0 A (1.67 Ω Resistor Load)

USB-A: 5 V / 2.4 A (2.08 Ω Resistor Load)

15.1 ESD Discharge at the End of the Output Cable

No.	Test Voltage	No. of Strikes	Discharge Location	Remarks	Pass/Fail
1	+8	10	+ USB-C End of cable	No Damage / No AR	Pass
2		10	- USB-C End of cable	No Damage / No AR	Pass
3		10	+ USB-A End of cable	No Damage / No AR	Pass
4		10	- USB-A End of cable	No Damage / No AR	Pass
1	-8	10	+ USB-C End of cable	No Damage / No AR	Pass
2		10	- USB-C End of cable	No Damage / No AR	Pass
3		10	+ USB-A End of cable	No Damage / No AR	Pass
4		10	- USB-A End of cable	No Damage / No AR	Pass
1	+12	10	+ USB-C End of cable	No Damage / No AR	Pass
2		10	- USB-C End of cable	No Damage / No AR	Pass
3		10	+ USB-A End of cable	No Damage / No AR	Pass
4		10	- USB-A End of cable	No Damage / No AR	Pass
1	-12	10	+ USB-C End of cable	No Damage / No AR	Pass
2		10	- USB-C End of cable	No Damage / No AR	Pass
3		10	+ USB-A End of cable	No Damage / No AR	Pass
4		10	- USB-A End of cable	No Damage / No AR	Pass
1	+15	10	+ USB-C End of cable	No Damage / No AR	Pass
2		10	- USB-C End of cable	No Damage / With AR	Pass
3		10	+ USB-A End of cable	No Damage / With AR	Pass
4		10	- USB-A End of cable	No Damage / No AR	Pass
1	-15	10	+ USB-C End of cable	No Damage / With AR	Pass
2		10	- USB-C End of cable	No Damage / No AR	Pass
3		10	+ USB-A End of cable	No Damage / No AR	Pass
4		10	- USB-A End of cable	No Damage / No AR	Pass

15.2 **ESD Discharge at the End of the PCB (Output Receptacle)**

No.	Test Voltage	No. of Strikes	Discharge Location	Remarks	Pass/Fail
1	+8	10	+ USB-C Connector (PCB)	No Damage / No AR	Pass
2		10	- USB-C Connector (PCB)	No Damage / No AR	Pass
3		10	+ USB-A Connector (PCB)	No Damage / No AR	Pass
4		10	- USB-A Connector (PCB)	No Damage / No AR	Pass
1	-8	10	+ USB-C Connector (PCB)	No Damage / No AR	Pass
2		10	- USB-C Connector (PCB)	No Damage / No AR	Pass
3		10	+ USB-A Connector (PCB)	No Damage / No AR	Pass
4		10	- USB-A Connector (PCB)	No Damage / No AR	Pass
1	+12	10	+ USB-C Connector (PCB)	No Damage / No AR	Pass
2		10	- USB-C Connector (PCB)	No Damage / No AR	Pass
3		10	+ USB-A Connector (PCB)	No Damage / No AR	Pass
4		10	- USB-A Connector (PCB)	No Damage / No AR	Pass
1	-12	10	+ USB-C Connector (PCB)	No Damage / No AR	Pass
2		10	- USB-C Connector (PCB)	No Damage / No AR	Pass
3		10	+ USB-A Connector (PCB)	No Damage / No AR	Pass
4		10	- USB-A Connector (PCB)	No Damage / No AR	Pass
1	+15	10	+ USB-C Connector (PCB)	No Damage / No AR	Pass
2		10	- USB-C Connector (PCB)	No Damage / With AR	Pass
3		10	+ USB-A Connector (PCB)	No Damage / No AR	Pass
4		10	- USB-A Connector (PCB)	No Damage / No AR	Pass
1	-15	10	+ USB-C Connector (PCB)	No Damage / No AR	Pass
2		10	- USB-C Connector (PCB)	No Damage / No AR	Pass
3		10	+ USB-A Connector (PCB)	No Damage / No AR	Pass
4		10	- USB-A Connector (PCB)	No Damage / With AR	Pass

Note: Additional tape insulation around the output capacitors (C12 and C13) helps improve ESD immunity up to 18 kV.

16 Brown-Out / Brown-Out Recovery Test

No abnormal overheating or voltage overshoot/undershoot was observed during and after 0.5 V / s. The unit works normally after the brown out test.

16.1 Brown-Out Test at $V_{USB-C} = 5 V$, $V_{USB-A} = 5 V$ Full Load

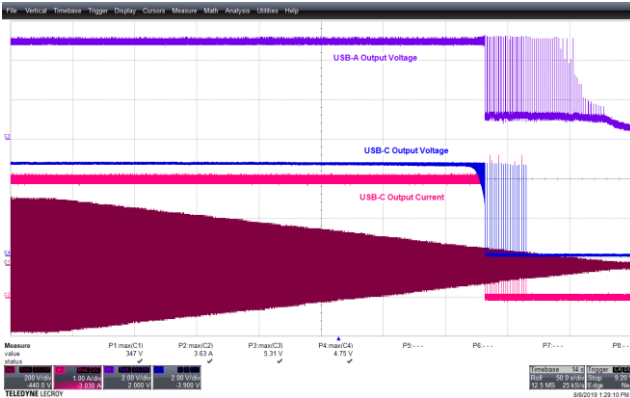

Figure 166 – Brown-Out from 230 V to 0 V.
 Slow Rate: 0.5 V / s.
 CH1(Brown): V_{IN} , 200 V / div.
 CH2(Pink): I_{USB-C} , 1 A / div., 50 s / div.
 CH3(Violet): V_{USB-A} , 2 V / div.
 CH4(Blue): V_{USB-A} , 2 V / div.

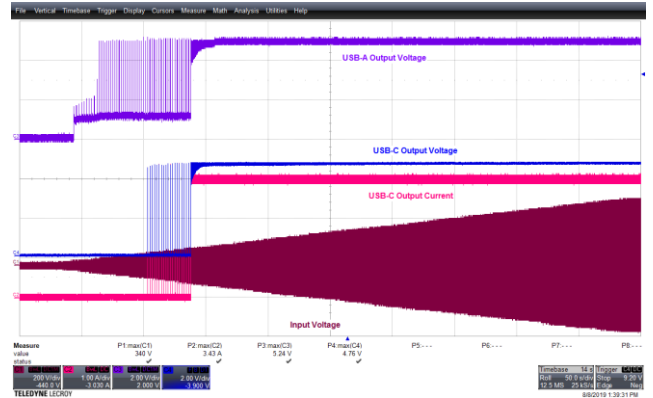

Figure 167 – Brown-Out Recovery 230 V to 0 V.
 Slow Rate: 0.5 V / s.
 CH1(Brown): V_{IN} , 200 V / div.
 CH2(Pink): I_{USB-C} , 1 A / div., 50 s / div.
 CH3(Violet): V_{USB-A} , 2 V / div.
 CH4(Blue): V_{USB-A} , 2 V / div.

16.2 Brown-Out Recovery Test at $V_{USB-C} = 20 V$, $V_{USB-A} = 5 V$ Full Load

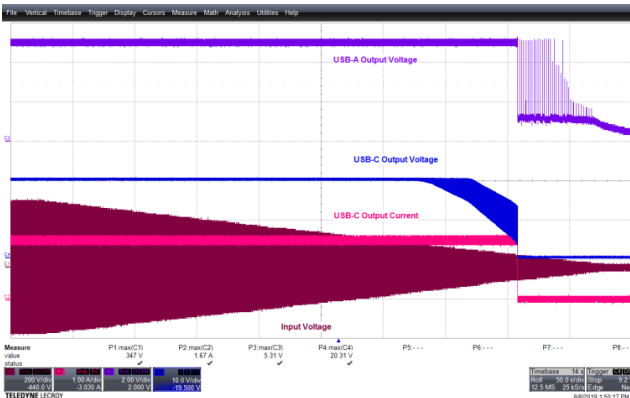

Figure 168 – Brown-Out from 230 V to 0 V.
 Slow Rate: 0.5 V / s.
 CH1(Brown): V_{IN} , 200 V / div.
 CH2(Pink): I_{USB-C} , 1 A / div., 50 s / div.
 CH3(Violet): V_{USB-A} , 2 V / div.
 CH4(Blue): V_{USB-A} , 10 V / div.

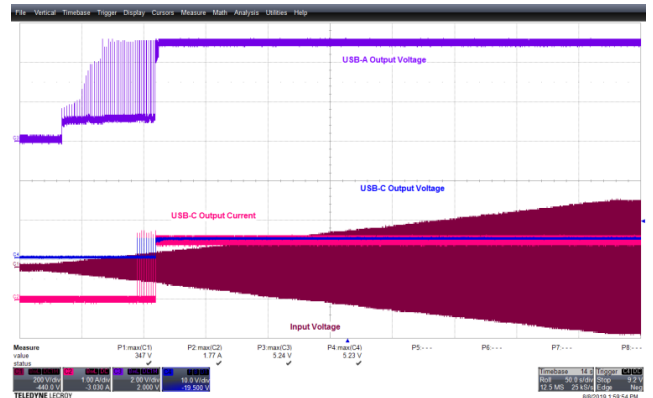

Figure 169 – Brown-Out Recovery 230 V to 0 V.
 Slow Rate: 0.5 V / s.
 CH1(Brown): V_{IN} , 200 V / div.
 CH2(Pink): I_{USB-C} , 1 A / div., 50 s / div.
 CH3(Violet): V_{USB-A} , 2 V / div.
 CH4(Blue): V_{USB-A} , 10 V / div.



17 Revision History

Date	Author	Revision	Description and Changes	Reviewed
29-Oct-19	MGM	1.0	Initial release	Apps & Mktg
13-Mar-20	MGM	1.1	Added L1 and L2 Specifications	Apps & Mktg
28-Jul-20	KM	1.2	Converted to RDR	Apps & Mktg



For the latest updates, visit our website: www.power.com

Reference Designs are technical proposals concerning how to use Power Integrations' gate drivers in particular applications and/or with certain power modules. These proposals are "as is" and are not subject to any qualification process. The suitability, implementation and qualification are the sole responsibility of the end user. The statements, technical information and recommendations contained herein are believed to be accurate as of the date hereof. All parameters, numbers, values and other technical data included in the technical information were calculated and determined to our best knowledge in accordance with the relevant technical norms (if any). They may be based on assumptions or operational conditions that do not necessarily apply in general. We exclude any representation or warranty, express or implied, in relation to the accuracy or completeness of the statements, technical information and recommendations contained herein. No responsibility is accepted for the accuracy or sufficiency of any of the statements, technical information, recommendations or opinions communicated and any liability for any direct, indirect or consequential loss or damage suffered by any person arising therefrom is expressly disclaimed.

Power Integrations reserves the right to make changes to its products at any time to improve reliability or manufacturability. Power Integrations does not assume any liability arising from the use of any device or circuit described herein. POWER INTEGRATIONS MAKES NO WARRANTY HEREIN AND SPECIFICALLY DISCLAIMS ALL WARRANTIES INCLUDING, WITHOUT LIMITATION, THE IMPLIED WARRANTIES OF MERCHANTABILITY, FITNESS FOR A PARTICULAR PURPOSE, AND NON-INFRINGEMENT OF THIRD PARTY RIGHTS.

Patent Information

The products and applications illustrated herein (including transformer construction and circuits' external to the products) may be covered by one or more U.S. and foreign patents, or potentially by pending U.S. and foreign patent applications assigned to Power Integrations. A complete list of Power Integrations' patents may be found at www.power.com. Power Integrations grants its customers a license under certain patent rights as set forth at <http://www.power.com/ip.htm>.

Power Integrations, the Power Integrations logo, CAPZero, ChiPhy, CHY, DPA-Switch, EcoSmart, E-Shield, eSIP, eSOP, HiperPLC, HiperPFS, HiperTFS, InnoSwitch, Innovation in Power Conversion, InSOP, LinkSwitch, LinkZero, LYTSwitch, SENZero, TinySwitch, TOPSwitch, PI, PI Expert, SCALE, SCALE-1, SCALE-2, SCALE-3 and SCALE-iDriver, are trademarks of Power Integrations, Inc. Other trademarks are property of their respective companies. ©2019, Power Integrations, Inc.

Power Integrations Worldwide Sales Support Locations

WORLD HEADQUARTERS

5245 Hellyer Avenue
San Jose, CA 95138, USA.
Main: +1-408-414-9200
Customer Service:
Worldwide: +1-65-635-64480
Americas: +1-408-414-9621
e-mail: usasales@power.com

CHINA (SHANGHAI)

Rm 2410, Charity Plaza, No. 88,
North Caoxi Road,
Shanghai, PRC 200030
Phone: +86-21-6354-6323
e-mail: chinasales@power.com

CHINA (SHENZHEN)

17/F, Hivac Building, No. 2, Keji
Nan 8th Road, Nanshan District,
Shenzhen, China, 518057
Phone: +86-755-8672-8689
e-mail: chinasales@power.com

GERMANY (AC-DC/LED Sales)

Einsteinring 24
85609 Dornach/Aschheim
Germany
Tel: +49-89-5527-39100
e-mail: eurosales@power.com

GERMANY (Gate Driver Sales)

HellwegForum 1
59469 Ense
Germany
Tel: +49-2938-64-39990
e-mail: igbt-driver.sales@power.com

INDIA

#1, 14th Main Road
Vasanthanagar
Bangalore-560052
India
Phone: +91-80-4113-8020
e-mail: indiasales@power.com

ITALY

Via Milanese 20, 3rd Fl.
20099 Sesto San Giovanni (MI) Italy
Phone: +39-024-550-8701
e-mail: eurosales@power.com

JAPAN

Yusen Shin-Yokohama 1-chome Bldg.
1-7-9, Shin-Yokohama, Kohoku-ku
Yokohama-shi,
Kanagawa 222-0033 Japan
Phone: +81-45-471-1021
e-mail: japansales@power.com

KOREA

RM 602, 6FL
Korea City Air Terminal B/D,
159-6
Samsung-Dong, Kangnam-Gu,
Seoul, 135-728 Korea
Phone: +82-2-2016-6610
e-mail: koreasales@power.com

SINGAPORE

51 Newton Road,
#19-01/05 Goldhill Plaza
Singapore, 308900
Phone: +65-6358-2160
e-mail:
singaporesales@power.com

TAIWAN

5F, No. 318, Nei Hu Rd.,
Sec. 1
Nei Hu District
Taipei 11493, Taiwan R.O.C.
Phone: +886-2-2659-4570
e-mail: taiwansales@power.com

UK

Building 5, Suite 21
The Westbrook Centre
Milton Road
Cambridge
CB4 1YG
Phone: +44 (0) 7823-557484
e-mail: eurosales@power.com