

OA938EC Series

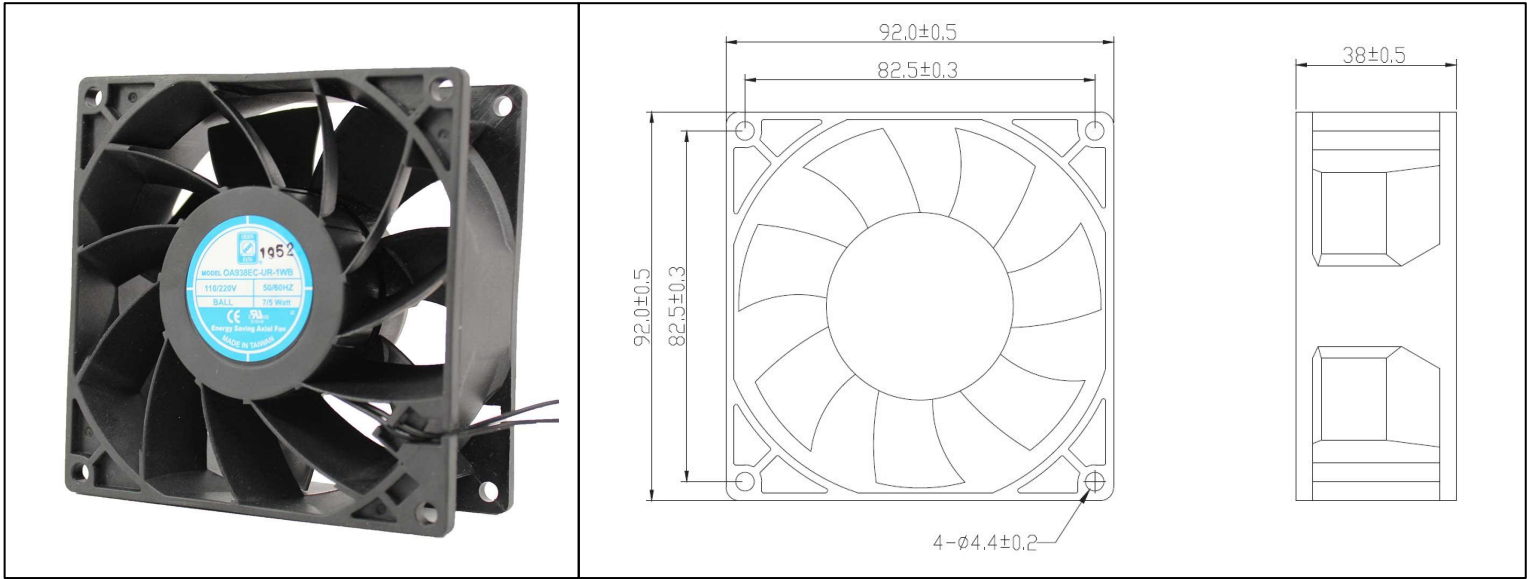

EC Fan Universal Voltage
92x38mm (3.62" x 1.50")



Frame	PBT UL94V0- Plastic	<u>Operating Temperature</u> -10C ~ +70C <u>Storage Temperature</u> -40C ~ +75C <u>Life Expectancy</u> 70,000 hours (L10 at 40C) Weight: ~ 0.42 lbs m0	
Impeller	PBT UL94V0- Plastic		
Connection	Wire Leads		
Motor	AC-DC Energy Saving, Electronically Protected		
Bearing System	Dual Ball Bearings		
Dielectric Strength	1500VAC/min		

Part Number	OA938EC-UR-1WB
Rated Voltage	110/220 VAC
Voltage Range	85 ~ 265
Rated Input	7 ~ 5 (2.2)W
Rated Speed (RPM)	3000
Airflow (CFM)	60
Noise Level (dB)	43
Max. Static Pressure	0.27"H ₂ O