



MS5837-07BA

Ultra-small, gel filled dual range pressure sensor, with stainless steel cap

The MS5837-07BA is a high-resolution altimeter sensor from TE Connectivity with I²C bus interface. The MS5837-07BA26 is the high endurance pad technology and lid shielded version of this pressure sensor module.

This sensor is optimized for barometric pressure range but also for water depth measurement systems with a resolution of 31cm. The sensor module includes a high linearity pressure sensor and an ultra-low power 24-bit $\Delta\Sigma$ ADC with internal factory calibrated coefficients. It provides an accurate digital 24-bit pressure and temperature value and different operation modes that allow the user to optimize for conversion speed and current consumption. A high-resolution temperature output allows the implementation in depth measurement systems and thermometer function without any additional sensor. The MS5837-07BA can be interfaced to virtually any microcontroller. The communication protocol is straightforward, without the need of programming internal registers in the device. The gel protection and antimagnetic stainless-steel cap make the module water resistant. Enhanced construction and design materials allow for enhanced chemical endurance in applications with harsh liquid media environments with limited exposure.

Small dimensions of only 3.3 mm x 3.3 mm x 1.7 mm allows integration in mobile devices. This sensor module generation is based on leading MEMS technology and latest benefits from TE Connectivity (TE) proven experience and know-how in high volume manufacturing of altimeter and high-pressure modules, which has been widely used for over a decade.

APPLICATIONS

- Adventure or Multi-mode Watches
- Mobile Water Depth Measurement Systems

FEATURES

- Ceramic and metal package: 3.3 x 3.3 x 2.75mm
- Barometric and high-pressure range
- Supply voltage: 1.5 to 3.6 V
- Fast conversion down to 0.5 ms
- Low power, 0.6 μ A (standby \leq 0.1 μ A at 25°C)
- Integrated digital pressure sensor (24-bit $\Delta\Sigma$ ADC)
- Operating range: 0 to 7 bar, -20 to +85 °C
- I²C interface
- No external components (internal oscillator)
- Water resistant sealing with 1.8 x 0.8mm O-ring
- High chemical endurance
- Shielded metal lid

PERFORMANCE SPECIFICATIONS

ABSOLUTE MAXIMUM RATINGS

Parameter	Symbol	Conditions	Min.	Typ.	Max	Unit
Supply voltage	V _{DD}		-0.3		+4	V
Storage temperature	T _S		-40		+85	°C
Overpressure	P _{max}	ISO 22810 / 6425 ⁽¹⁾			30	bar
Maximum Soldering Temperature ⁽²⁾	T _{max}	40 sec. max			250	°C
ESD rating (lid to GND version)		Human Body Model	-2		+2	kV
Latch up		JEDEC JESD78 standard	-100		+100	mA

⁽¹⁾ Pressure ramp up/down min 60s

⁽²⁾ Refer to application note 808

ELECTRICAL CHARACTERISTICS

Parameter	Symbol	Conditions	Min.	Typ.	Max	Unit
Operating Supply voltage	V _{DD}		1.5	3.0	3.6	V
Operating Temperature	T		-20	+25	+85	°C
Supply current (1 sample per sec.)	I _{DD}	OSR		20.09 10.05 5.02 2.51 1.26 0.63		µA
Peak supply current		during conversion		1.25		mA
Standby supply current		at 25°C (V _{DD} = 3.0 V)		0.01	0.1	µA
Power supply hold off for internal reset ⁽³⁾		V _{DD} < 0.1V	200			ms
VDD Capacitor		from VDD to GND	100	470		nF
Resistor value between the lid and the GND		Version 07BA2x only		1000		Ω

⁽³⁾ Supply voltage power up must be continuous from GND to VDD without any step

ANALOG DIGITAL CONVERTER (ADC)

Parameter	Symbol	Conditions	Min.	Typ.	Max	Unit
Output Word				24		bit
Conversion time ⁽⁴⁾	t _c	OSR		16.44 8.22 4.13 2.08 1.06 0.54	18.08 9.04 4.54 2.28 1.17 0.6	ms

⁽⁴⁾ Maximum values must be used to determine waiting times in I2C communication

PERFORMANCE SPECIFICATIONS (CONTINUED)

PRESSURE OUTPUT CHARACTERISTICS (V_{DD} = 3 V, T = 25°C UNLESS OTHERWISE NOTED)

Parameter	Conditions		Min.	Typ.	Max	Unit
Operating Pressure Range	P _{range}	Full Accuracy	0		7	bar
Relative Accuracy ^{(1) (4)} Temperature range: 10 ... 40°C	600 ... 1100 mbar		-2		2	mbar
Relative Accuracy ^{(1) (4)} Temperature range: 0 ... 60°C	300 ... 1100 mbar		-4		4	mbar
	0 ... 5000 mbar		-30		30	mbar
Relative Accuracy ^{(1) (4)} Temperature range: -20 ... 85°C	300 ... 1100 mbar		-15		15	mbar
	0 ... 7000 mbar		-75		75	mbar
Maximum error with supply voltage ⁽²⁾	V _{DD} = 1.5 V ... 3.6 V			±4		mbar
Long-term stability				±5		mbar/yr
Reflow soldering impact	IPC/JEDEC J-STD-020C			±6		mbar
Recovering time after reflow ⁽³⁾				7		days
Resolution RMS	OSR	8192		0.031		mbar
		4096		0.044		
		2048		0.061		
		1024		0.089		
		512		0.133		
		256		0.242		

⁽¹⁾ With autozero at one pressure point

⁽²⁾ With autozero at 3V point

⁽³⁾ Time to recover at least 66% of reflow impact

⁽⁴⁾ Wet/dry cycle: sensor must be dried typically once a day

TEMPERATURE OUTPUT CHARACTERISTICS (V_{DD} = 3 V, T = 25°C UNLESS OTHERWISE NOTED)

Parameter	Conditions		Min.	Typ.	Max	Unit
Absolute Accuracy ⁽⁵⁾	0...60°C, 600...1100 mbar			±1		°C
	-20...85°C, 0...7000 mbar		-2.5		+2.5	°C
Maximum error with supply voltage	V _{DD} = 1.5 V ... 3.6 V			±0.3		°C
Resolution RMS	OSR	8192		0.002		°C
		4096		0.003		
		2048		0.004		
		1024		0.006		
		512		0.009		
		256		0.012		

⁽⁵⁾ Typical reflow impact drift: ±1°C

MS5837-07BA

Ultra-small gel filled dual range pressure sensor, with stainless steel cap

PERFORMANCE SPECIFICATIONS (CONTINUED)

DIGITAL INPUTS (SDA, SCL)

Parameter	Symbol	Conditions	Min.	Typ.	Max	Unit
Serial data clock	SCL				400	kHz
Input high voltage	V _{IH}		80% V _{DD}		100% V _{DD}	V
Input low voltage	V _{IL}		0% V _{DD}		20% V _{DD}	V
Input leakage current	I _{leak}	T = 25 °C			0.1	μA

DIGITAL OUTPUTS (SDA)

Parameter	Symbol	Conditions	Min.	Typ.	Max	Unit
Output high voltage	V _{OH}	I _{source} = 1 mA	80% V _{DD}		100% V _{DD}	V
Output low voltage	V _{OL}	I _{sink} = 1 mA	0% V _{DD}		20% V _{DD}	V

MS5837-07BA

Ultra-small gel filled dual range pressure sensor, with stainless steel cap

TYPICAL PERFORMANCE CHARACTERISTICS

PRESSURE ERROR VS PRESSURE AND TEMPERATURE

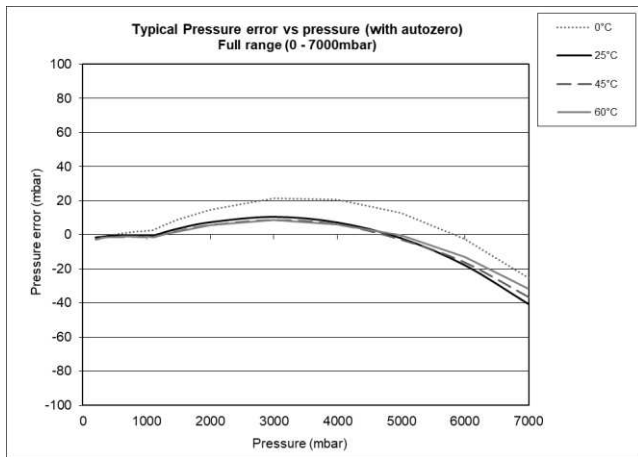
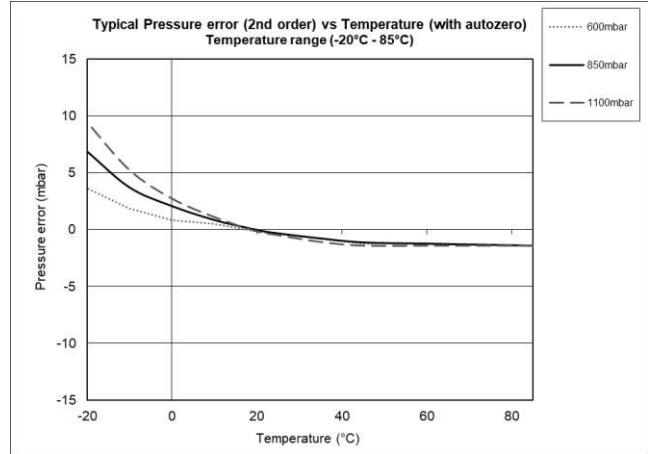
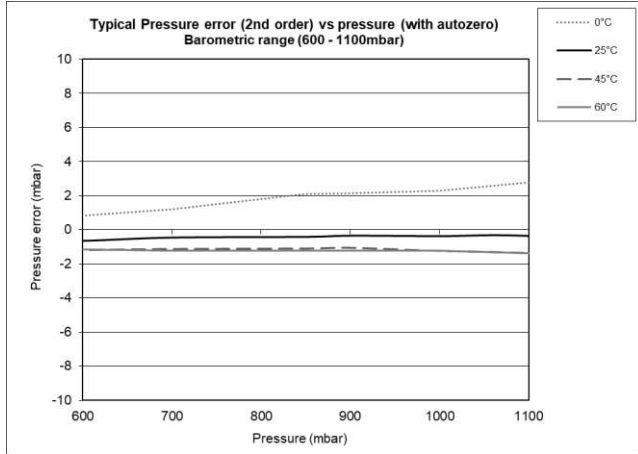

MS5837-07BA

Ultra-small gel filled dual range pressure sensor, with stainless steel cap

TEMPERATURE ERROR VS PRESSURE AND TEMPERATURE

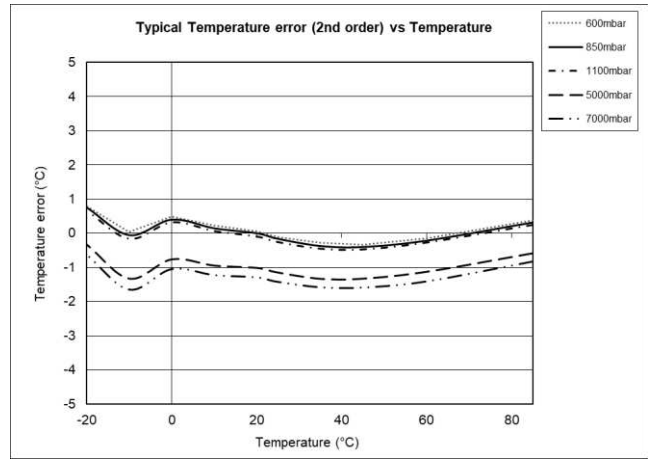
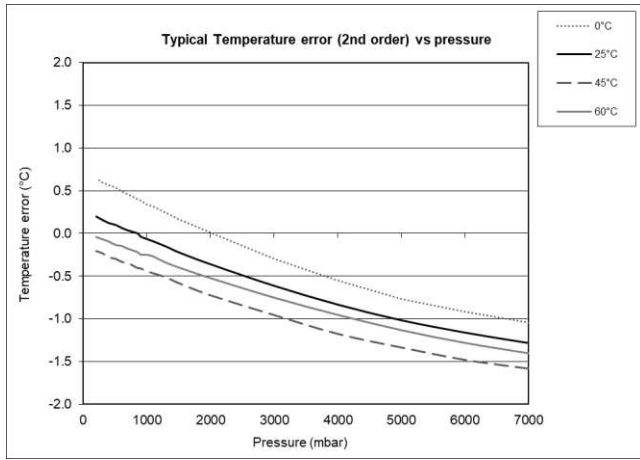

RELATIVE PRESSURE AND TEMPERATURE ERROR VS POWER SUPPLY

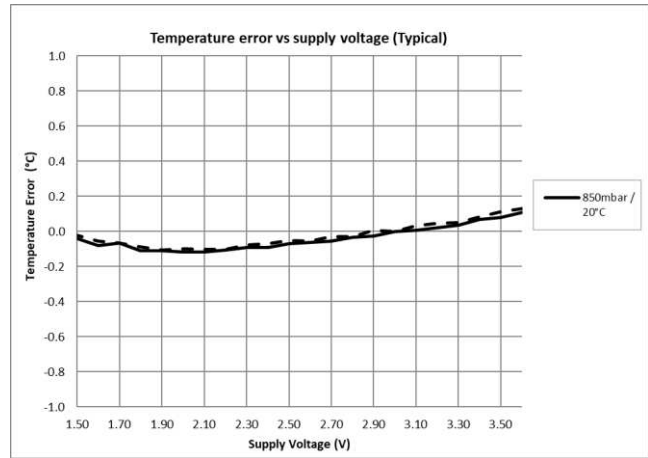
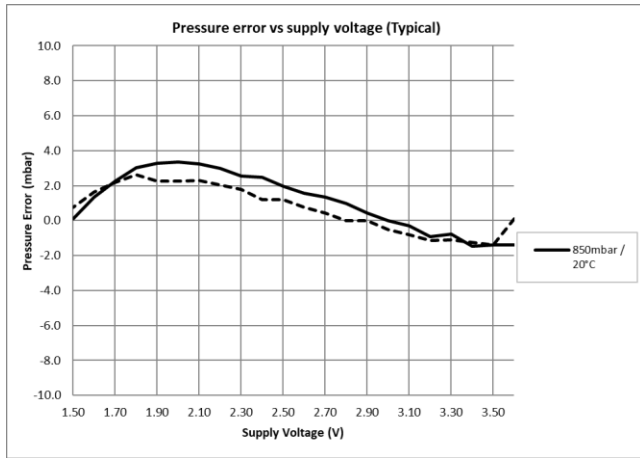

MS5837-07BA

Ultra-small gel filled dual range pressure sensor, with stainless steel cap

PRESSURE AND TEMPERATURE CALCULATION

GENERAL

The MS5837-07BA consists of a piezo-resistive sensing element and an IC interface. The main function of the MS5837-07BA is to provide a 24-bit pressure and temperature representation out of the uncompensated analog output voltage from the piezo-resistive sensing element.

FACTORY CALIBRATION

Every module is individually factory calibrated at two temperatures and three pressures. As a result, 8 coefficients necessary to compensate for process and temperature variations are calculated and stored in the 112 bits PROM of each module. These bits (stored in 16 bits word from W0 to W6) must be read and used together with the D1 and D2 values to get the compensated pressure and temperature values.

The coefficient W0 contains also factory configuration bits and a CRC, as represented in the Figure 3: Word 0, bits description.

SERIAL I²C INTERFACE

The external microcontroller clocks in the data through the input SCL (Serial CLock) and SDA (Serial DAta). The sensor responds on the same pin SDA which is bidirectional for the I²C bus interface. This interface type uses only 2 signal lines and does not require a chip select.

Module ref	Mode	Pins used	Address (7 bits)
MS5837-07BA	I ² C	SDA, SCL	0x76 (1110110 b)

FIRST ORDER PRESSURE AND TEMPERATURE CALCULATION

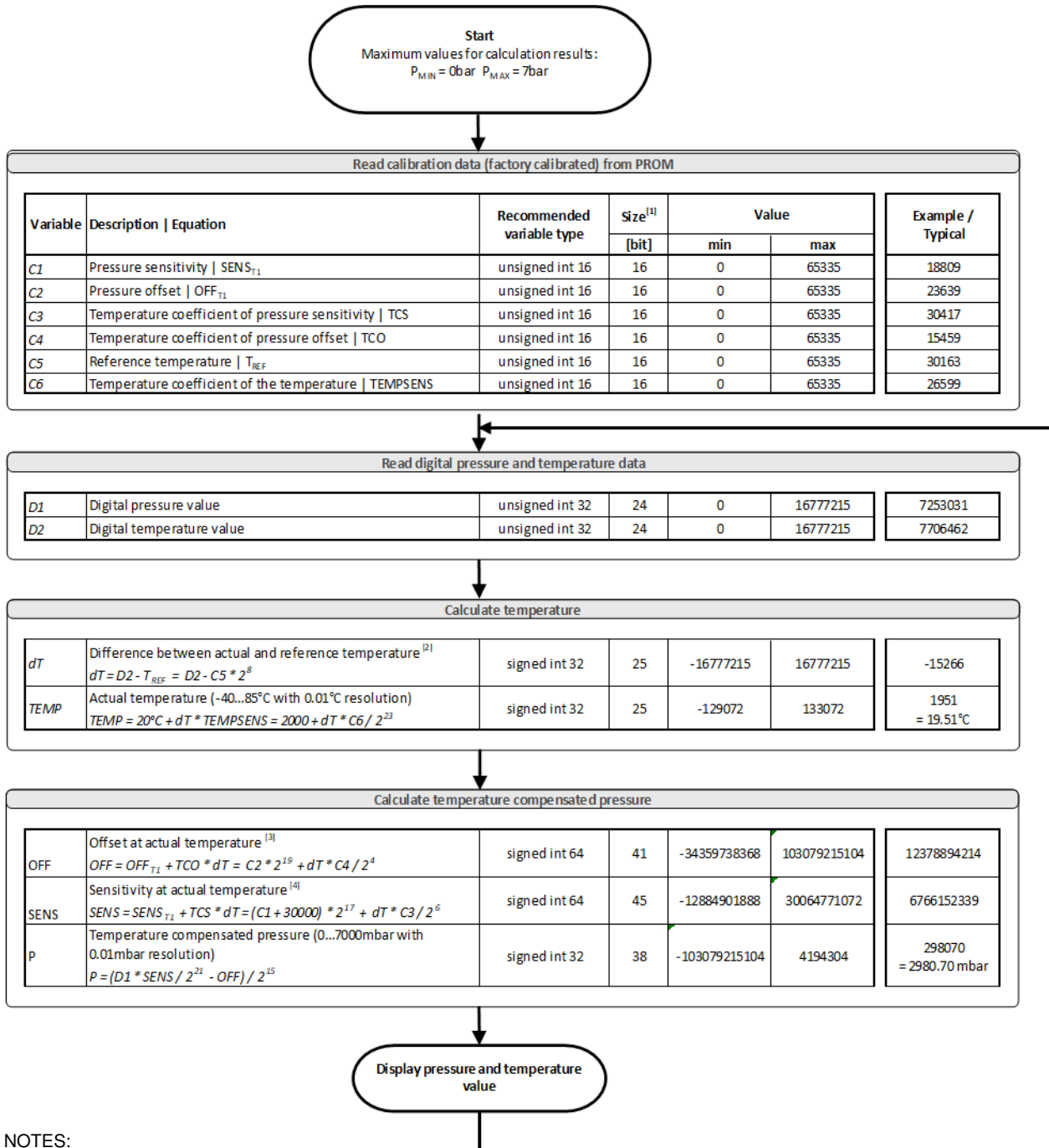

NOTES:

- [1]: Maximal size of intermediate results during evaluation of variables
- [2]: Min and Max must be defined
- [3]: Min and Max must be defined
- [4]: Min and Max must be defined

Figure 1 : Pressure and temperature first order

SECOND ORDER TEMPERATURE COMPENSATION

The results of the first order calculation are used as described in the following chart to obtain the 2nd order pressure and temperature compensated values.

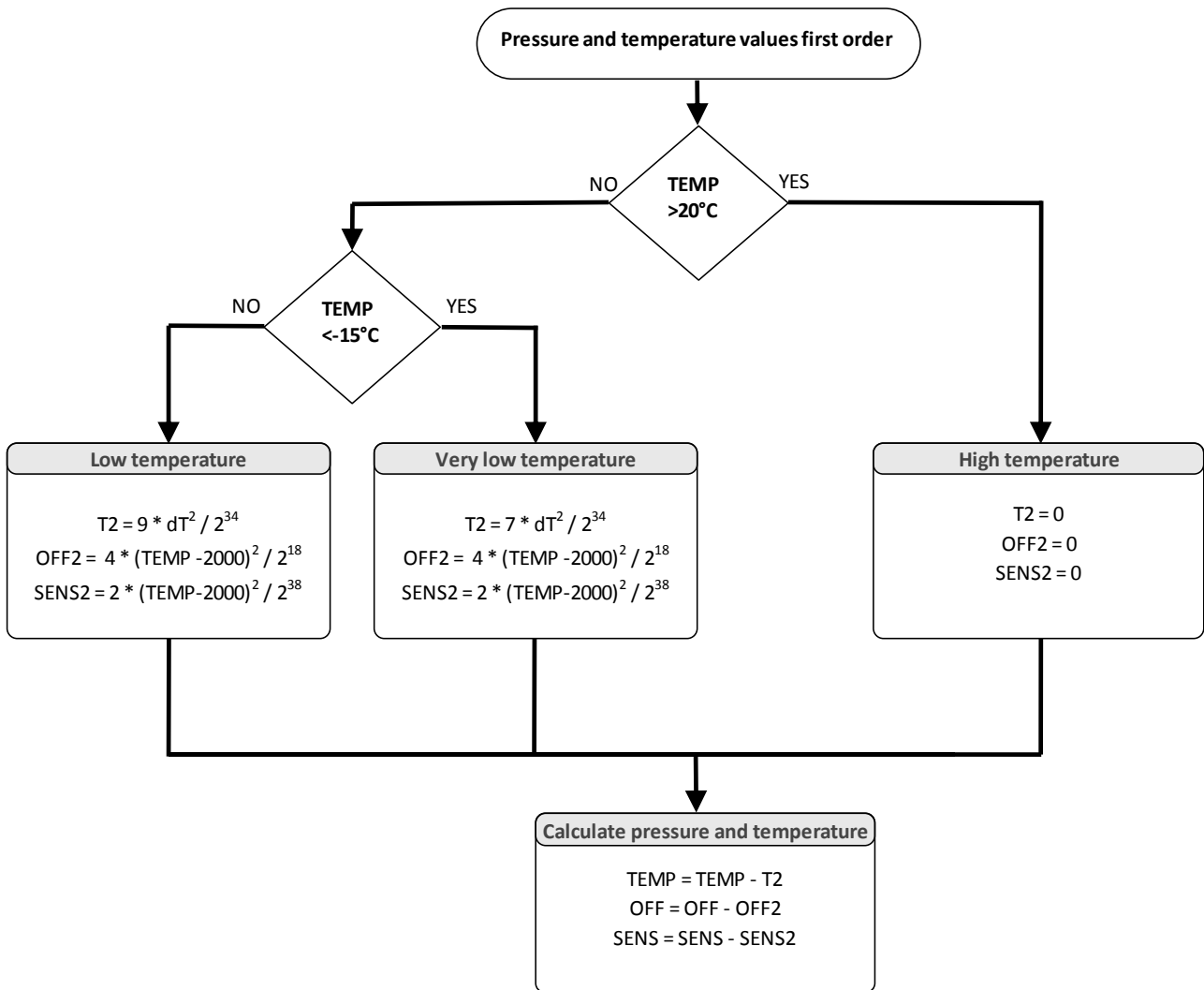

Figure 2 : Second order compensation flowchart

HIGH PRESSURE RANGE COMPENSATION

Word 0 (16 bits) of the PROM stores high pressure range compensation coefficients and is defined as follow:

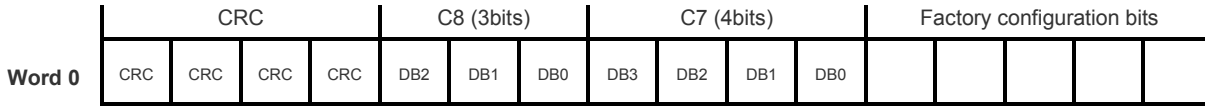

Figure 3: Word 0, bits description

Bits 5 to 8 (4 bits) of W0 correspond to C7, the 3 following bits (bits 9 to 11) correspond to C8 coefficient and the last 4 bits (bits 12 to 15) correspond to the CRC.

When defining P and T as the pressure and temperature issued from the raw data calculation, the compensated high pressure P3 is defined as follow:

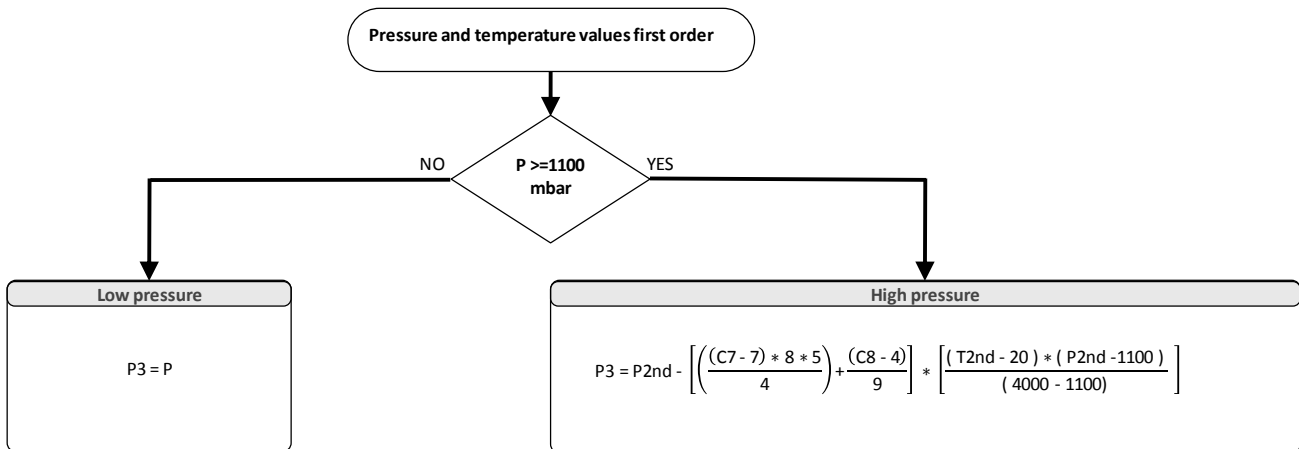

Figure 4: Flow chart for high pressure P3 calculation

I²C INTERFACE

COMMANDS

The MS5837-07BA has only five commands:

1. Reset
2. Read PROM (112 bits of calibration words)
3. D1 conversion
4. D2 conversion
5. Read ADC result (24 bits pressure / temperature)

Size of each command is 1 byte (8 bits) as described in the table (Figure 5: Command structure) below. After the PROM read command, sensor responds with 16 bits word. Bits A2, A1 and A0 select PROM addresses.

Conversion is started after a “Convert D1” or “Convert D2” with the requested OSR is issued. Conversion time depends on the OSR as shown in the table specifications page 2 (ANALOG DIGITAL CONVERTER (adc)

. Maximum waiting time values need to be used to ensure finished operation.

ADC read command will return 24 bits result of the above requested finished conversion.

Bit number	Command byte								hex value
	0	1	2	3	4	5	6	7	
Bit name	PR M	COV	-	Typ	A2/ Os2	A1/ Os1	A0/ Os0	Stop	
Command									
Reset	0	0	0	1	1	1	1	0	0x1E
Convert D1 (OSR=256)	0	1	0	0	0	0	0	0	0x40
Convert D1 (OSR=512)	0	1	0	0	0	0	1	0	0x42
Convert D1 (OSR=1024)	0	1	0	0	0	1	0	0	0x44
Convert D1 (OSR=2048)	0	1	0	0	0	1	1	0	0x46
Convert D1 (OSR=4096)	0	1	0	0	1	0	0	0	0x48
Convert D2 (OSR=256)	0	1	0	1	0	0	0	0	0x50
Convert D2 (OSR=512)	0	1	0	1	0	0	1	0	0x52
Convert D2 (OSR=1024)	0	1	0	1	0	1	0	0	0x54
Convert D2 (OSR=2048)	0	1	0	1	0	1	1	0	0x56
Convert D2 (OSR=4096)	0	1	0	1	1	0	0	0	0x58
ADC Read	0	0	0	0	0	0	0	0	0x00
PROM Read	1	0	1	0	A2	A1	A0	0	0xA0 to 0xAC

Figure 5: Command structure

RESET SEQUENCE

The reset sequence shall be sent once after power-on to make sure that the calibration PROM gets loaded into the internal register. It can be also used to reset the device PROM from an unknown condition. The reset can be sent at any time. In the event that there is not a successful power on reset this may be caused by the SDA being blocked by the module in the acknowledge state. The only way to get the MS5837-07BA to function is to send several SCLs followed by a reset sequence or to perform a power OFF-ON cycle.

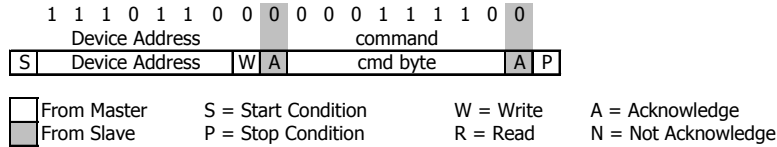

Figure 6: I2C Reset Command

PROM READ SEQUENCE

The read command for PROM must be executed once after reset by the user software to read the content of the calibration PROM and extract / store the calibration coefficients. There are 7 addresses resulting in a total memory content of 112 bits. Memory words contain: factory data, calibration coefficients and CRC. Command sequence is 8 bits wide and slave responses will send back 16 bits result which is clocked with the MSB first. The PROM read command is divided in two parts. Firstly, ASIC is set into PROM read mode and address of the requested word is issued. Then, content of addressed memory word is read.

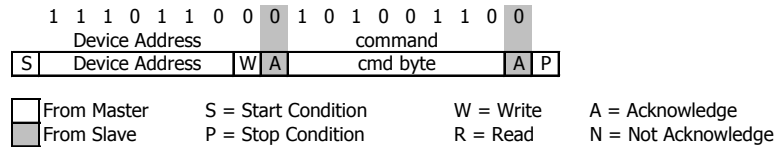

Figure 7: I2C Command to read memory address= 011

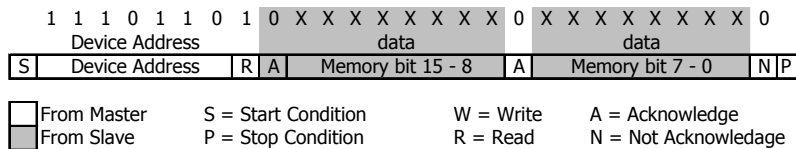

Figure 8: I2C answer from MS5837-07BA

CONVERSION SEQUENCE

The conversion command is used to initiate uncompensated pressure (D1) or uncompensated temperature (D2) conversion. Once finished, raw values are read using “ADC read command”. Result is clocked out with MSB first. If conversion is not finished before sending the “ADC read command”, or the “ADC read command” is repeated, conversion will not stop but issued result will be wrong. Conversion sequence command sent during the already started conversion process will yield incorrect result as well.

Once command issued, the ADC will start converting the values from the sensing element into digital 24 bits format. Conversion time is dependent from selected OSR (page 2 § ANALOG DIGITAL CONVERTER (ADC)

After the conversion is performed, the data can be accessed by sending a read command as shown below.

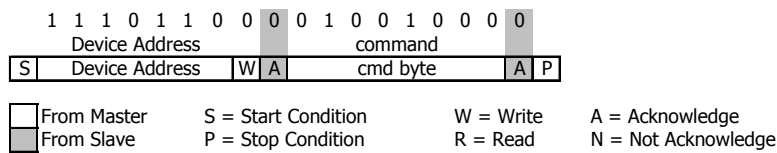

Figure 9: I2C command to initiate a pressure conversion (OSR=4096, typ=D1)

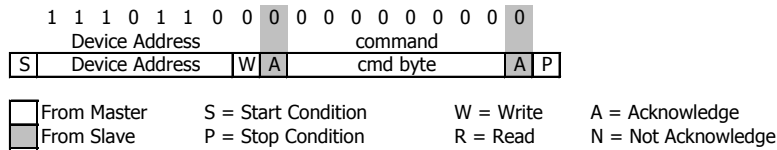

Figure 10: I2C ADC read sequence

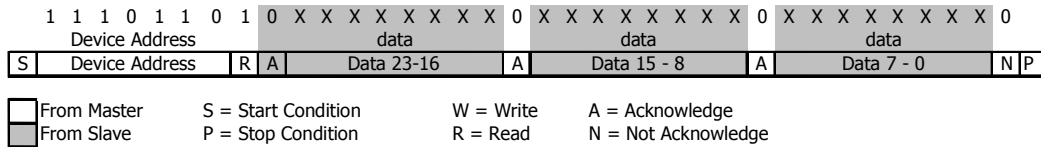

Figure 11: I2C answer from MS5837-07BA

CYCLIC REDUNDANCY CHECK (CRC)

A 4-bits CRC has been implemented to check the data validity in memory. The CRC read in the first four bits of W0 must be equal to the CRC calculated (see algorithm below) with all other PROM bits to ensure memory content integrity.

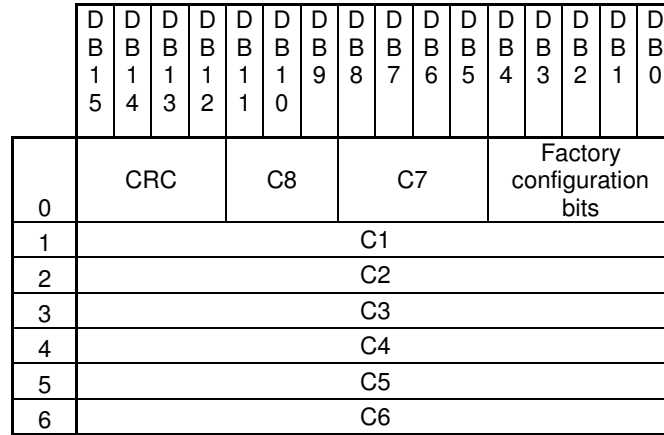

Figure 12: Memory PROM mapping

C Code algorithm for CRC-4 calculation:

```

unsigned char crc4(unsigned int n_prom[]) // n_prom defined as 8x unsigned int (n_prom[8])
{
    int cnt; // simple counter
    unsigned int n_rem=0; // crc remainder
    unsigned char n_bit;

    n_prom[0]=((n_prom[0] & 0x0FFF); // CRC byte is replaced by 0
    n_prom[7]=0; // Subsidiary value, set to 0
    for (cnt = 0; cnt < 16; cnt++) // operation is performed on bytes
    { // choose LSB or MSB

        if (cnt%2==1) n_rem ^= (unsigned short) ((n_prom[cnt]>>1] & 0x00FF);
        else n_rem ^= (unsigned short) (n_prom[cnt]>>1]>>8);
        for (n_bit = 8; n_bit > 0; n_bit--)
        {
            if (n_rem & (0x8000)) n_rem = (n_rem << 1) ^ 0x3000;
            else n_rem = (n_rem << 1);
        }
    }
    n_rem= ((n_rem >> 12) & 0x000F); // final 4-bit remainder is CRC code
    return (n_rem ^ 0x00);
}
    
```

MS5837-07BA

Ultra-small gel filled dual range pressure sensor, with stainless steel cap

APPLICATION CIRCUIT EXAMPLE

The MS5837-07BA is a sensor that can be used in conjunction with a microcontroller in mobile altimeter applications. A typical application circuit is presented in Figure 13.

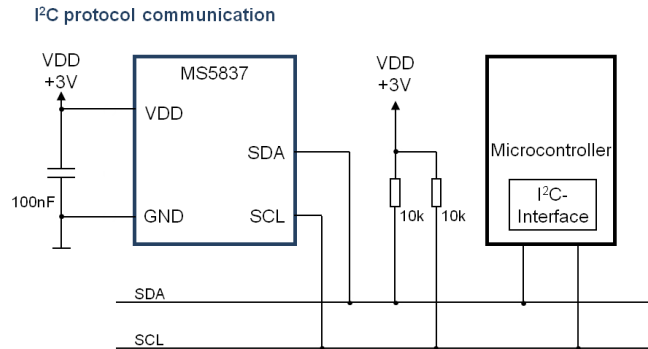

Figure 13: Typical application circuit

PIN CONFIGURATION AND DEVICE PACKAGE OUTLINE

UNLESS OTHERWISE SPECIFIED DIMENSIONS ARE IN MILLIMETERS. GENERAL TOLERANCE IS ± 0.1 mm

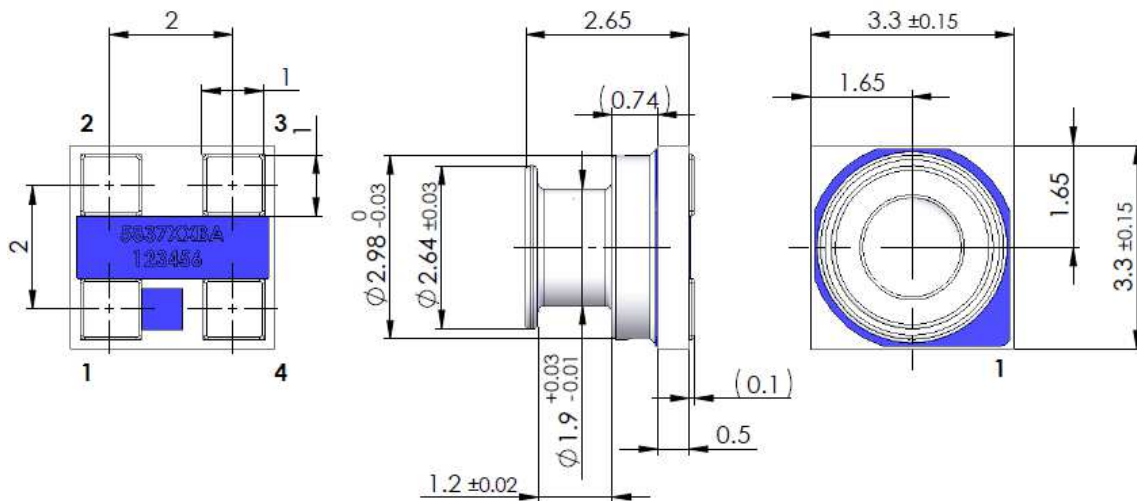

Figure 14: Package outline and pin configuration

1	GND	GROUND
2	VDD	POSITIVE SUPPLY
3	SCL	I2C CLOCK
4	SDA	I2C DATA

MS5837-07BA

Ultra-small gel filled dual range pressure sensor, with stainless steel cap

RECOMMENDED PAD LAYOUT

Pad layout for bottom side of the MS5837-07BA soldered onto a printed circuit board.

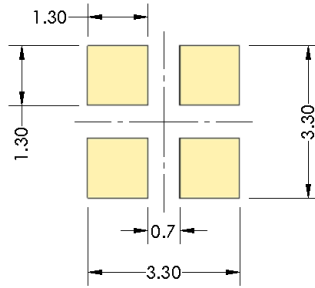
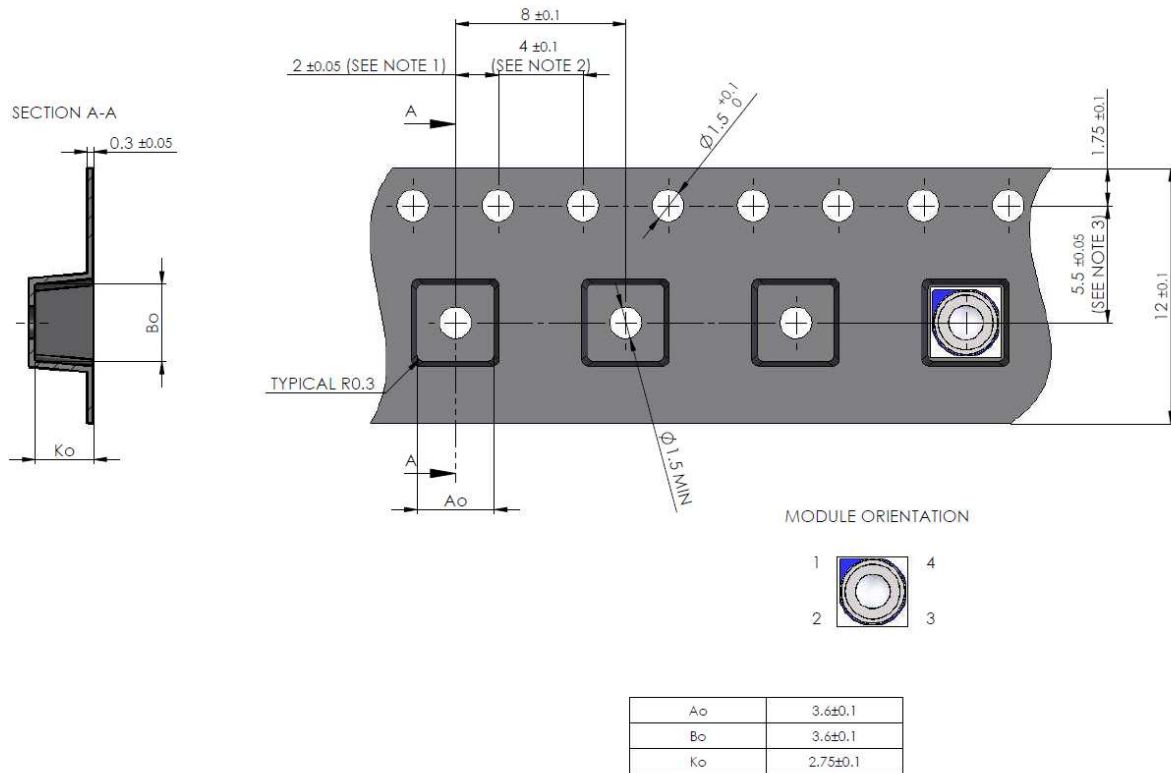

Figure 15: PCB footprint

SHIPPING PACKAGE



NOTE:

- 1: Measured from centerline of sprocket hole to centerline of pocket
- 2: Cumulative tolerance of 10 sprocket holes is ±0.2mm
- 3: Measured from centerline of sprocket hole to centerline of pocket

Figure 16: Tape dimensions

MOUNTING AND ASSEMBLY CONSIDERATIONS

SOLDERING

Please refer to the application note AN808 available on our website for all soldering recommendations.

MOUNTING

The MS5837-07BA can be placed with automatic pick & place equipment using vacuum nozzles. It will not be damaged by the vacuum. Due to the low stress assembly the sensor does not show pressure hysteresis effects.

CONNECTION TO PCB

The package outline of the module allows the use of a flexible PCB. This is ideal for small-sized applications.

SEALING WITH O-RINGS

This module is designed to allow sealing the pressure port from connections side, to protect electronics against direct water or humidity using an O-ring.

It shall be placed at the groove location, i.e. the small outer diameter of the metal lid. The following table shows recommended dimensions:

O-ring inner diameter	1.8 ± 0.05 mm
O-ring cross-section diameter	0.8 ± 0.03 mm
Housing bore diameter	3.07 ± 0.03 mm

Please refer to the application note available on our website for O-ring mounting recommendations (MS5837 Series O-Ring mount.pdf).

CLEANING

The MS5837-07BA has been manufactured under clean-room conditions. It is therefore recommended to assemble the sensor under class 10'000 or better conditions. Should this not be possible, it is recommended to protect the sensor opening during assembly from entering particles and dust. To avoid cleaning of the PCB, solder paste of type "no-clean" shall be used.

Warning: cleaning might damage the sensor.

ESD PRECAUTIONS

The electrical contact pads are protected against ESD up to 2 kV HBM (human body model). It is therefore essential to ground machines and personal properly during assembly and handling of the device. The MS5837-07BA is shipped in antistatic transport boxes. Any test adapters or production transport boxes used during the assembly of the sensor shall be of an equivalent antistatic material.

DECOUPLING CAPACITOR

Particular care must be taken when connecting the device to the power supply. A minimum of 100nF ceramic capacitor must be placed as close as possible to the MS5837-07BA VDD pin. This capacitor will stabilize the power supply during data conversion and thus, provide the highest possible accuracy.

MS5837-07BA

Ultra-small gel filled dual range pressure sensor, with stainless steel cap

ORDERING INFORMATION

PART NUMBER	DESCRIPTION	SHIELDING	HIGH ENDURANCE
20005303-00	MS5837-07BA26 07BA DUAL RANGE HE LS T&R	X	X

NORTH AMERICA

Tel +1 800 522 6752
customercare.frm@te.com

EUROPE

Tel +31 73 624 6999
customercare.bevx@te.com

ASIA

Tel +86 0400 820 6015
customercare.shzn@te.com

te.com/sensorsolutions

Measurement Specialties (MEAS), TE Connectivity, TE Connectivity (logo) and EVERY CONNECTION COUNTS are trademarks. All other logos, products and/or c herein might be trademarks of their respective owners.

The information given herein, including drawings, illustrations and schematics which are intended for illustration purposes only, is believed to be reliable. However, warranties as to its accuracy or completeness and disclaims any liability in connection with its use. TE Connectivity's obligations shall only be as set forth in TE Connect Conditions of Sale for this product and in no case will TE Connectivity be liable for any incidental, indirect or consequential damages arising out of the sale, resale, us Users of TE Connectivity products should make their own evaluation to determine the suitability of each such product for the specific application.

© 2018 TE Connectivity Ltd. family of companies All Rights Reserved.

