

## Automotive 600 V, 60 A ultrafast bridge module

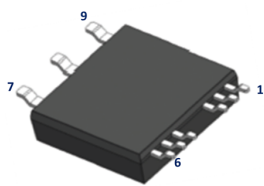

ACEPACK SMIT

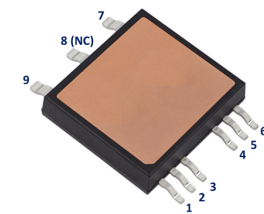
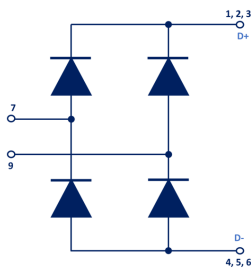

## Features

- Operating  $T_j$  from  $-40\text{ }^\circ\text{C}$  to  $+175\text{ }^\circ\text{C}$
- Ultrafast with soft recovery behaviour
- PPAP capable
- SMD with isolated top side cooling
- Low thermal resistance
- Backside in insulated ceramic
- Dice chips on Direct Bond Copper (DBC) substrate
- ECOPACK2 compliant
- MSL: Level 3
- Insulation voltage (UL 1557):  $V_{RMS} = 4000\text{ V}$



## Applications

- Output rectification
- On board charger
- Charging station

## Description

The ultrafast bridge rectifier is a high-performance device, generally used in a full wave rectification of an output stage of a DC/DC converter in automotive applications.

Thanks to the high thermal capability of the ACEPACK SMIT package, this integrated module will increase the power density in the application, through very high thermal performances (top side cooling) and insulation done by an embedded ceramic. Especially suited for use in Charger applications, either integrated in the vehicle or in a charging station, this rectifier will enhance the performance of the targeted application.

## Product status link

[STTH60RQ06-M2Y](#)

## Device summary (per diode)

$I_{F(AV)}$	30 A
$V_{RRM}$	600 V
$V_F$ (typ.)	1.45 V
$t_{rr}$ (max.)	30 ns
$T_j$	$-40\text{ }^\circ\text{C}$ to $+175\text{ }^\circ\text{C}$

# 1 Characteristics

**Table 1. Absolute ratings (limiting values, at 25 °C, unless otherwise specified)**

Symbol	Parameter		Value	Unit	
$V_{RRM}$	Repetitive peak reverse voltage		$T_j = -40\text{ °C to }+175\text{ °C}$	600	V
$I_{F(RMS)}$	Forward rms current		Per diode	50	A
$I_{F(AV)}$	Average forward current $\delta = 0.5$ , square wave	$T_C = 77\text{ °C}$	Per diode	30	A
$I_{D(AV)}$	Bridge output current $\delta = 0.5$ , square wave	$T_C = 77\text{ °C}$		60	
$I_{FSM}$	Surge non repetitive forward current		$t_p = 10\text{ ms sinusoidal}, T_C = 25\text{ °C}$	180	A
$T_{stg}$	Storage temperature range			-65 to +175	°C
$T_j$	Operating junction temperature range			-40 to +175	°C

**Table 2. Thermal resistance parameters**

Symbol	Parameter	Typ. value	Max. value	Unit
$R_{th(j-c)}$	Junction to case per diode	1.03	1.25	°C/W

For more information, please refer to the following application note related to the thermal management:

- AN5384: ACEPACK SMIT module package guidelines for mounting and thermal management

**Table 3. Static electrical characteristics per diode**

Symbol	Parameter	Test conditions		Min.	Typ.	Max.	Unit
$I_R^{(1)}$	Reverse leakage current	$T_j = 25\text{ °C}$	$V_R = V_{RRM}$	-		40	$\mu\text{A}$
		$T_j = 150\text{ °C}$		-	80	800	
$V_F^{(2)}$	Forward voltage drop	$T_j = 25\text{ °C}$	$I_F = 15\text{ A}$	-		2.45	V
		$T_j = 150\text{ °C}$		-	1.15	1.45	
		$T_j = 25\text{ °C}$	$I_F = 30\text{ A}$	-		2.95	
		$T_j = 150\text{ °C}$		-	1.45	1.85	

1. Pulse test:  $t_p = 5\text{ ms}, \delta < 2\%$

2. Pulse test:  $t_p = 380\text{ }\mu\text{s}, \delta < 2\%$

To evaluate the conduction losses, use the following equation:

$$P = 1.05 \times I_{F(AV)} + 0.026 \times I_F^2_{(RMS)}$$

**Table 4. Dynamic electrical characteristics per diode**

Symbol	Parameter	Test conditions		Min.	Typ.	Max.	Unit
$t_{rr}$	Reverse recovery time	$T_j = 25\text{ °C}$	$I_F = 0.5\text{ A}, I_R = 1\text{ A},$ $I_{rr} = 0.25\text{ A}$	-		30	ns
			$I_F = 1\text{ A}, V_R = 30\text{ V},$ $dI_F/dt = -50\text{ A}/\mu\text{s}$	-	40	55	
$I_{RM}$	Reverse recovery current	$T_j = 125\text{ °C}$	$I_F = 30\text{ A}, V_R = 400\text{ V},$ $dI_F/dt = -200\text{ A}/\mu\text{s}$	-	8	11	A
$Q_{rr}$	Reverse recovery charge			-	485	-	nC
$t_{rr}$	Reverse recovery time			-	95	-	ns

For more information, please refer to the following application notes related to the power losses:

- AN604: Calculation of conduction losses in a power rectifier
- AN5028: Calculation of turn-off power losses generated by an ultrafast diode

## 1.1 Characteristics (curves)

**Figure 1. Forward voltage drop versus forward current (typical values)**

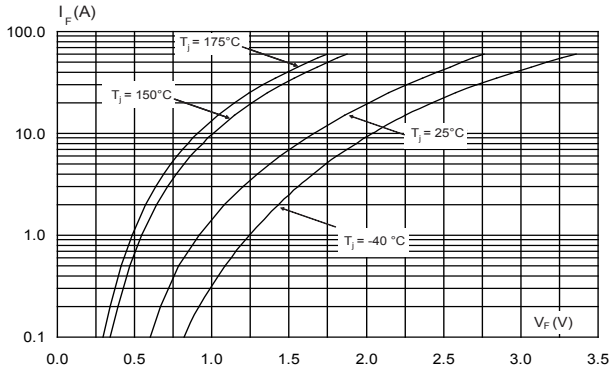

**Figure 2. Forward voltage drop versus forward current (maximum values)**

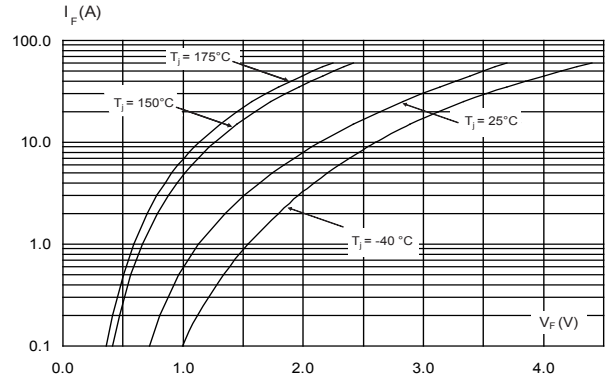

**Figure 3. Relative variation of thermal impedance junction to case versus pulse duration**

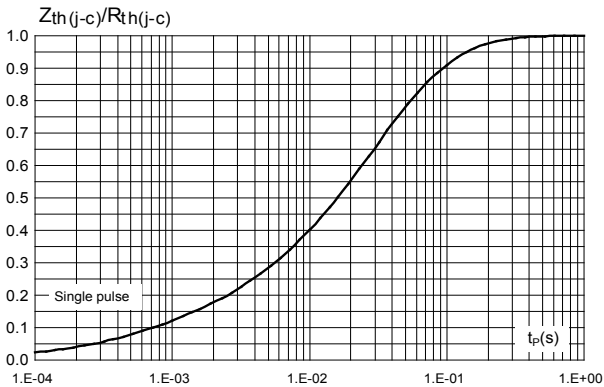

**Figure 4. Peak reverse recovery current versus  $di_F/dt$  (typical values)**

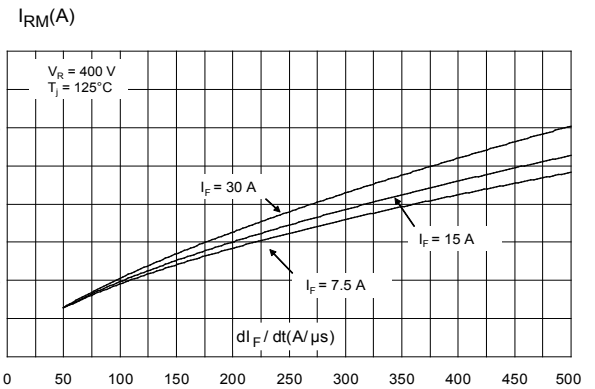

**Figure 5. Reverse recovery time versus  $di_F/dt$  (typical values)**

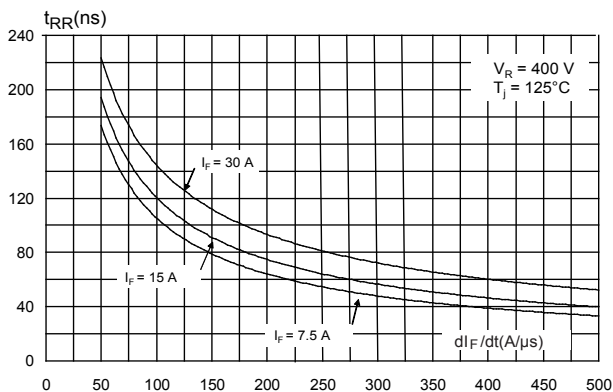

**Figure 6. Reverse recovery charges versus  $di_F/dt$  (typical values)**

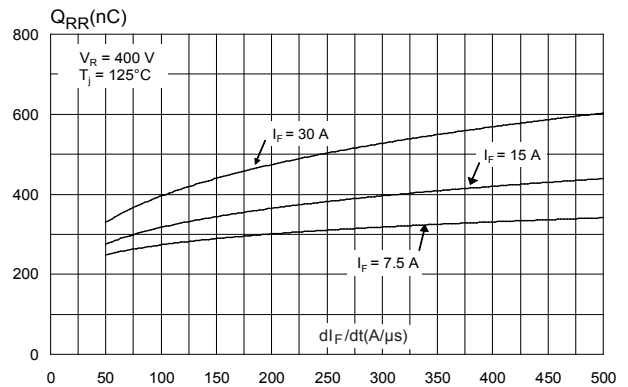

**Figure 7. Reverse recovery softness factor versus  $di_F/dt$  (typical values)**

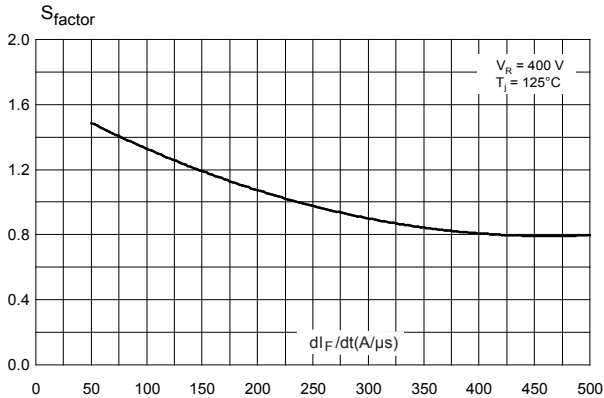

**Figure 8. Relative variations of dynamic parameters versus junction temperature**

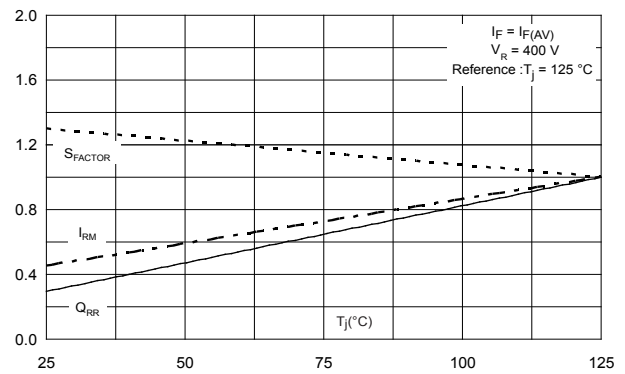

**Figure 9. Junction capacitance versus reverse voltage applied (typical values)**

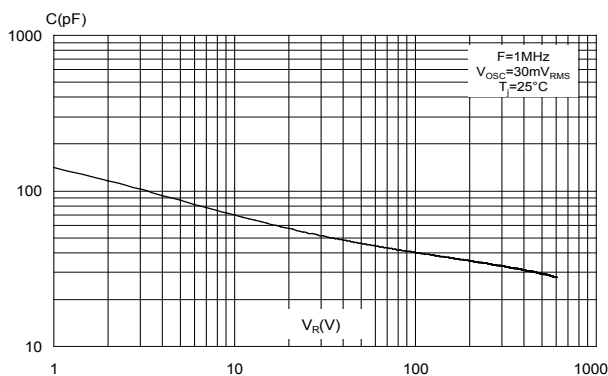

**Figure 10. Relative variation of non-repetitive peak surge forward current versus pulse duration (sinusoidal waveform)**

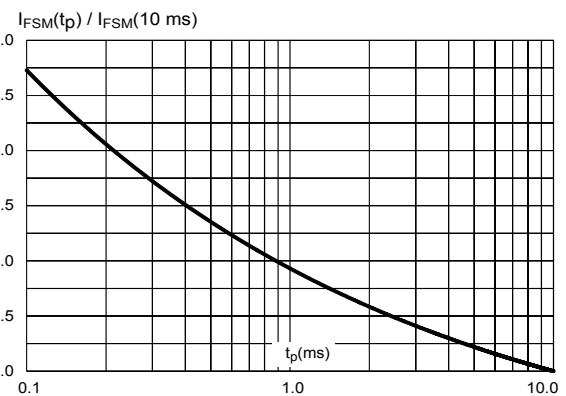

**Figure 11. Relative variation of non-repetitive peak surge forward current versus initial junction temperature (sinusoidal waveform)**

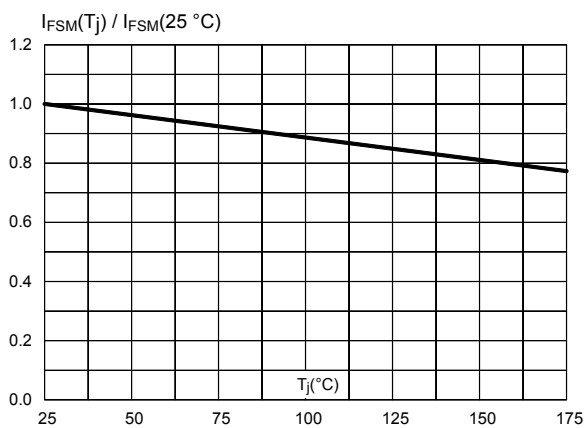

**Figure 12. Average forward current versus case temperature ( $\delta = 0.5$ )**

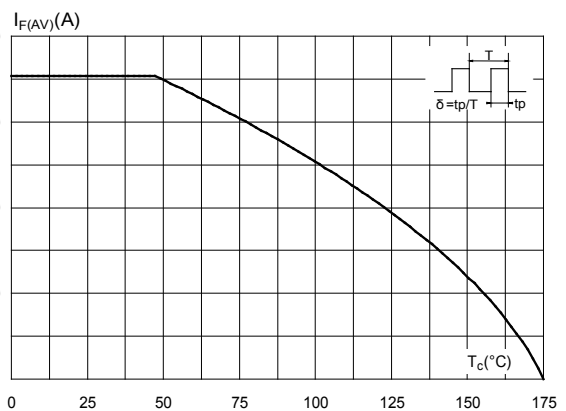

## 2 Package information

In order to meet environmental requirements, ST offers these devices in different grades of **ECOPACK** packages, depending on their level of environmental compliance. ECOPACK specifications, grade definitions and product status are available at: [www.st.com](http://www.st.com). ECOPACK is an ST trademark.

### 2.1 ACEPACK SMIT package information

Figure 13. ACEPACK SMIT package outline

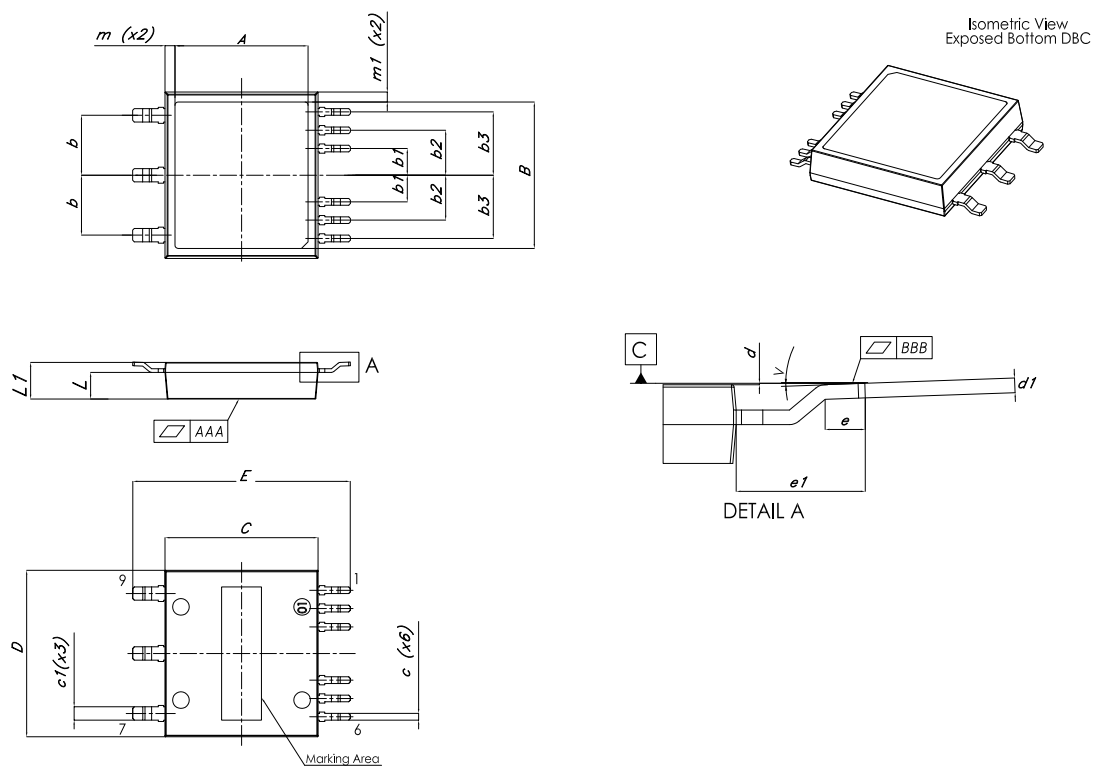

**Table 5. ACEPACK SMIT package mechanical data**

Ref.	Dimensions					
	Millimeters			Inches (for reference only)		
	Min.	Typ.	Max.	Min.	Typ.	Max.
A	19.50	20.00	20.50	0.768	0.787	0.807
B	21.50	22.00	22.50	0.846	0.866	0.886
C	22.80	23.00	23.20	0.898	0.906	0.913
D	24.80	25.00	25.20	0.976	0.984	0.992
E	32.20	32.70	33.20	1.268	1.287	1.307
b		9.00			0.354	
b1		4.00			0.157	
b2		6.75			0.266	
b3		9.50			0.374	
C	0.95	1.00	1.10	0.037	0.039	0.043
C1	1.95	2.00	2.10	0.077	0.079	0.083
d	0.00		0.15	0.000		0.006
d1	0.45	0.55	0.65	0.018	0.022	0.026
e	1.30	1.50	1.70	0.051	0.059	0.067
e1	4.65	4.85	5.05	0.183	0.191	0.199
L	3.95	4.00	4.05	0.156	0.157	0.159
L1	5.40	5.50	5.60	0.313	0.217	0.220
m	1.30	1.50	1.80	0.051	0.050	0.071
m1	1.30	1.50	1.80	0.051	0.050	0.071
V	0°	2°	4°			
AAA	0.01		0.05	0.000		0.002
BBB	0.00		0.10	0.000		0.004

Figure 14. ACEPACK SMIT recommended footprint (dimensions are in mm)

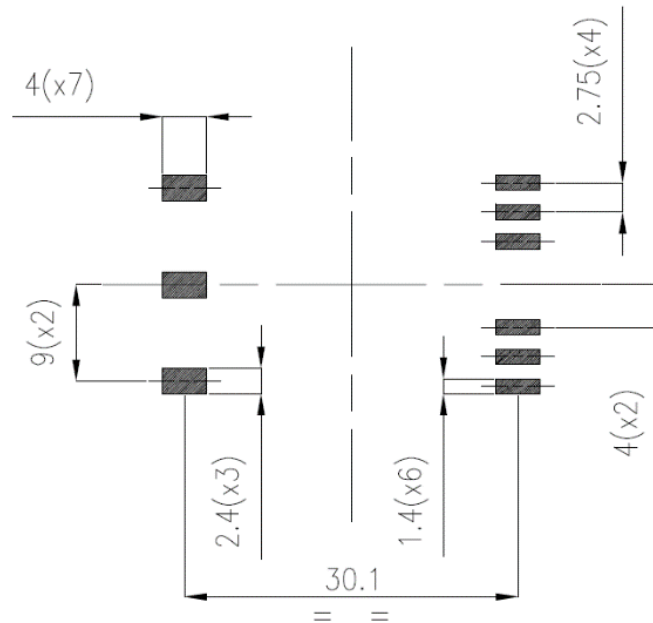



## 2.2 ACEPACK SMIT other information

**Table 6. Creepage distance and insulated voltage**

Symbol	Parameter	Value			Unit
		Min.	Typ.	Max.	
d <sub>creepage</sub>	creepage distance (see Figure 15)	Terminal to terminal (pin 3 to 4)	6.6	-	mm
		Terminal to backside	4.0	-	
V <sub>INS</sub>	Insulation voltage	Tab to leads; t = 1 minute 50-60Hz; RMS; I <sub>INS</sub> < 1 mA	-	4000	V

For assembly recommendations, please refer to AN5384.

**Figure 15. Creepage distance measurement**

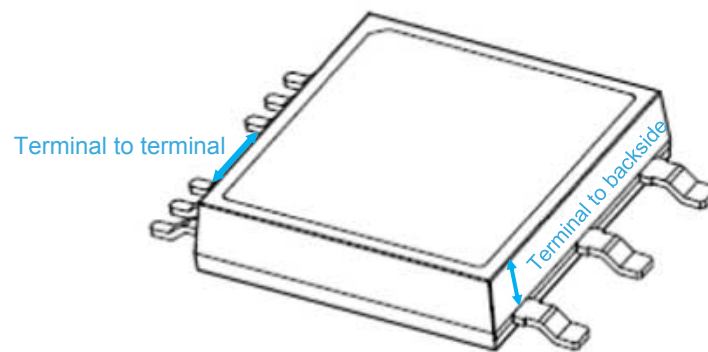

### 3 Ordering information

**Table 7. Ordering information**

Order code	Marking	Package	Weight	Base qty.	Delivery mode
STTH60RQ06-M2Y	STTH60RQ06-M2Y	ACEPACK SMIT	8.1 g	200	Tape and reel

## Revision history

**Table 8. Document revision history**

Date	Revision	Changes
15-Sep-2020	1	Initial release.

**IMPORTANT NOTICE – PLEASE READ CAREFULLY**

STMicroelectronics NV and its subsidiaries (“ST”) reserve the right to make changes, corrections, enhancements, modifications, and improvements to ST products and/or to this document at any time without notice. Purchasers should obtain the latest relevant information on ST products before placing orders. ST products are sold pursuant to ST’s terms and conditions of sale in place at the time of order acknowledgement.

Purchasers are solely responsible for the choice, selection, and use of ST products and ST assumes no liability for application assistance or the design of Purchasers’ products.

No license, express or implied, to any intellectual property right is granted by ST herein.

Resale of ST products with provisions different from the information set forth herein shall void any warranty granted by ST for such product.

ST and the ST logo are trademarks of ST. For additional information about ST trademarks, please refer to [www.st.com/trademarks](http://www.st.com/trademarks). All other product or service names are the property of their respective owners.

Information in this document supersedes and replaces information previously supplied in any prior versions of this document.

© 2020 STMicroelectronics – All rights reserved