

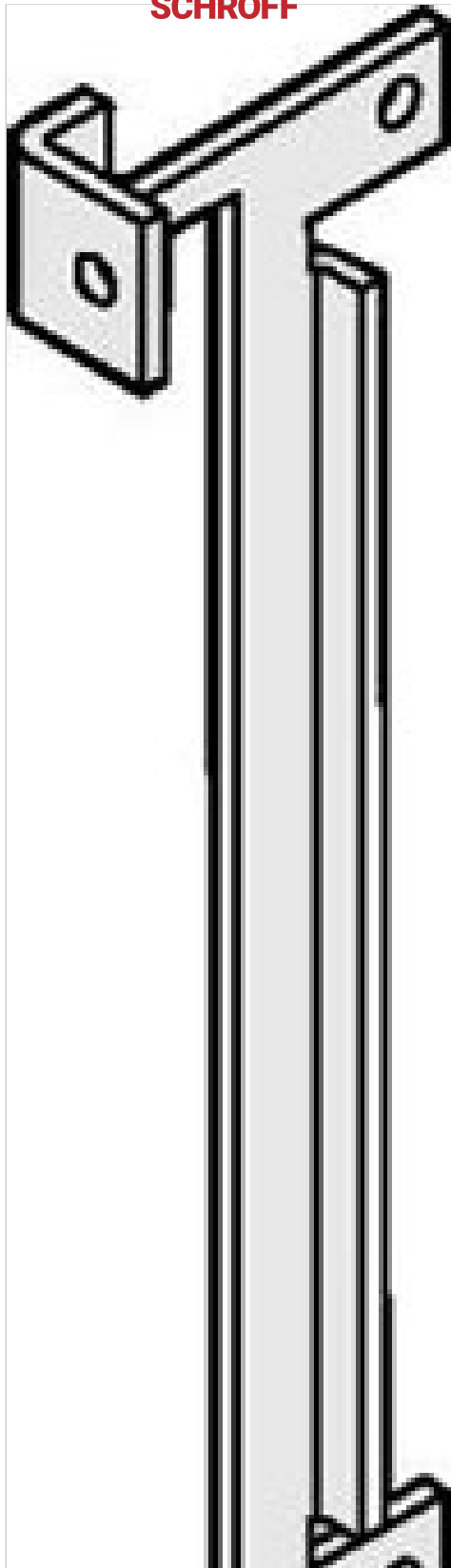

**SCHROFF**



**SCHROFF**

**Board support, plastic, double (4xM2.5)**

Catalog Number: 60807-011

- For fixing PCB to front panel



We use cookies to personalize content and ads, to provide social media features and to analyze our traffic. We also share information about your use of our site with our social media, advertising and analytics partners. [Cookie Policy](#).

[> Cookie Settings](#)

[✓ Accept Cookies](#)

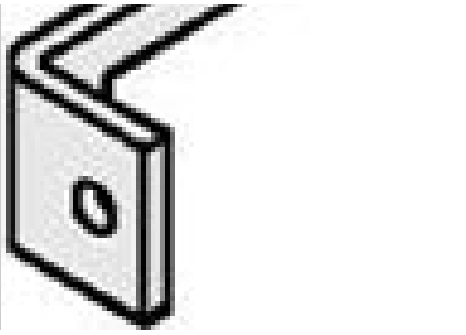

Other Views

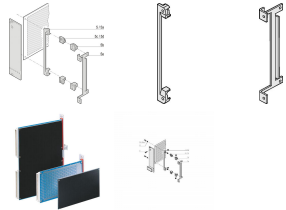

## Description

---

### Mechanics:

PCB covers and PCB case

### Product family:

- PCB Accessories
- Plug in units

### Note:

- Required quantity at 6 U : 4 units
- Required quantity at 3 U : 2 units
- Delivery is in standard pack multiples. Pricing is per individual item

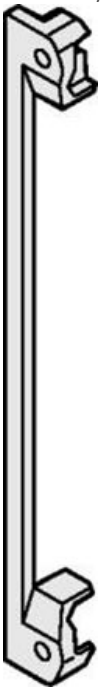

We use cookies to personalize content and ads, to provide social media features and to analyze our traffic. We also share information about your use of our site with our social media, advertising and analytics partners. [Cookie Policy](#).

> [Cookie Settings](#)

✓ [Accept Cookies](#)

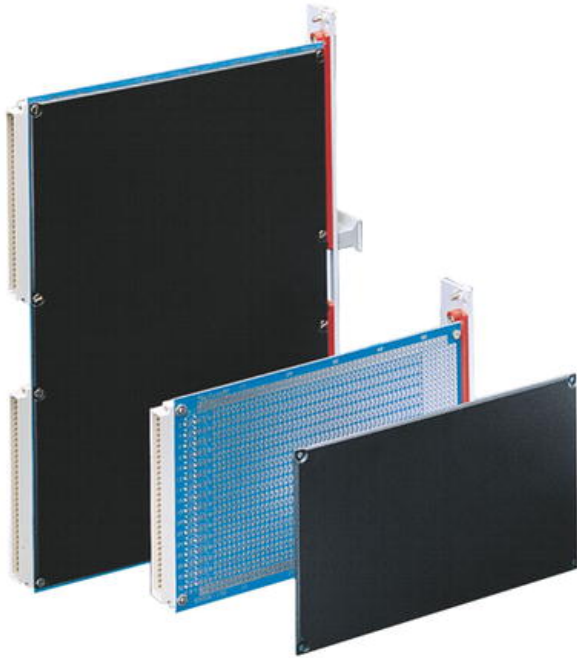
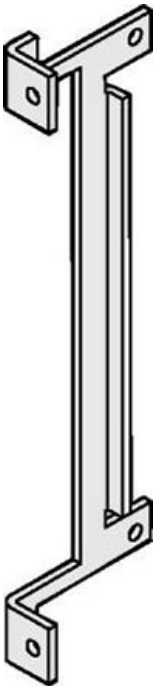

We use cookies to personalize content and ads, to provide social media features and to analyze our traffic. We also share information about your use of our site with our social media, advertising and analytics partners. [Cookie Policy](#).

> [Cookie Settings](#)

✓ [Accept Cookies](#)

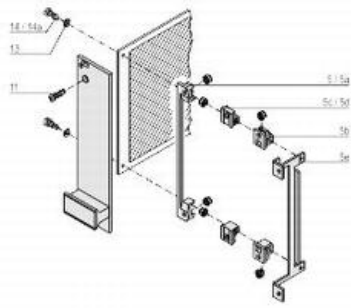

We use cookies to personalize content and ads, to provide social media features and to analyze our traffic. We also share information about your use of our site with our social media, advertising and analytics partners. [Cookie Policy](#).

> [Cookie Settings](#)

✓ [Accept Cookies](#)

### Technical Data

---

<b>Catalog Number</b>	<a href="#">60807-011</a>
<b>Color</b>	red
<b>Material</b>	PBT, UL 94 V-0
<b>Item</b>	13
<b>Required number at 3 U</b>	1
<b>Required number at 6 U</b>	2

We use cookies to personalize content and ads, to provide social media features and to analyze our traffic. We also share information about your use of our site with our social media, advertising and analytics partners. [Cookie Policy](#)

> [Cookie Settings](#)

✓ [Accept Cookies](#)

**Links**

---







Native CAD files

We use cookies to personalize content and ads, to provide social media features and to analyze our traffic. We also share information about your use of our site with our social media, advertising and analytics partners. [Cookie Policy](#).

[> Cookie Settings](#)

[Accept Cookies](#)

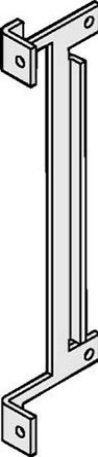
Accessories

Item		
	Board support, plastic, 1pcs (SPQ10)	60807-183
	PCB bracket, 4 thread M 2.5 for front panel/printed board fastening, PBT, UL 94 V-0, 1 piece	60807-211
	PCB bracket, 4 thread M2.5 for front panel/printed board fastening for recessed installation of printed board (20 mm), mounting depth 192.24 mm, zinc-plated steel, for europacPRO, ratiopacPRO, 1 piece	30808-871
	Board support, die-cast zinc (1xM2.5), 1pcs (SPQ10)	60807-203
	Board support, die-cast zinc (2xM2.5), 1pcs (SPQ10)	60807-181

We use cookies to personalize content and ads, to provide social media features and to analyze our traffic. We also share information about your use of our site with our social media, advertising and analytics partners. [Cookie Policy](#)

> [Cookie Settings](#)

✓ [Accept Cookies](#)