

POWER

Modular High Power System

Data Sheet

Up to 24000 Watts

Total Power: Up to 24 KW
Input Voltage: 180-264 Vac
 342-528 Vac
 Single or 3-Phase for iHP12
 3-Phase for iHP24
 540-660 Vac
 3-Phase for iHP24C
of Outputs: Up to 8



SPECIAL FEATURES

- 5 years manufacturer's warranty
- Multi output intelligent and modular high power system
- Standard 19" rack
- Outputs parallel up to 1600 A
- Outputs series up to 1000 V
- 100% digital control
- Outputs program as voltage or current source
- Versatile input configurable to:
 - Low line 180-264 Vac single phase and 3-phase
 - High line 342-528 Vac 3-phase
 - High line 540-660 Vac 3-phase (iHP24C)
- Medical safety approved – NO ISOLATION XFMR NEEDED
- Analog Interface either 0-5 V or 0-10 V for both current and voltage. Compatible with, but not limited to Priva, Argus, TrollMaster and Hortimax controllers
- Flexible digital control interfaces (Note 1)
- Air cooled
- Semi F47 compliance
- Field upgradeable firmware
- Programmable slew rate
- Fast current slew rate up to 200 Hz
- Active power factor correction
- User defined command profiles
- Very low THD compared to LED Drivers when used in lighting applications

SAFETY

- UL 60950-1 2nd Edition; EN60950-1; IEC60950-1/EN60950
- CSA C22.2 No. 60950-1-07, 2nd Edition
- EN60601-1; IEC60601-1; IEC60601
- UL 60601-1 1st Edition; ANSI/AAMI ES60601-1 (2005 + C1:09 + A2:10) 3rd Ed
- CAN/CSA-C22.2 No. 60601-1 (2008)
- CB Certificate and Report
- CE (LVD+RoHS), EN60950-1

iHP24 Electrical Specifications

Input Parameter	19" Rack 24 KW strapped as 3-phase 380/480 Vac Nominal (iHP24H3A)	19" Rack 24 KW strapped as 3-phase 208/240 Vac Nominal (iHP24L3A)	19" Rack 24 KW strapped as 3-phase 600 Vac Nominal (iHP24C3A)
Input range	342 Vac to 528 Vac (Nominal rating 380/480 Vac)	187.5 Vac to 264 Vac (Nominal rating 208/240 Vac)	540 Vac to 660 Vac (Nominal rating 600 Vac)
Number of phases	3-phase (Wye or Delta) 4 wire total (3-phase and 1 protective earth ground)		3-phase Wye 5 wire total (3-phases, neutral and protective earth ground)
Frequency	47-63 Hz		
Phase detection	Loss of phase will inhibit unit off. Housekeeping/comms must continue with phase loss.		
Max current/phase	51 A @ 342 Vac 40 A @ 432 Vac	84 A @ 187.5 Vac	29 A @ 312 Vac
Undervoltage detection	Nominal input locked on at turn-on. Undervoltage shutdown at 15% below nominal. Turn-on at 12% below nominal. Not to interfere with SEMI F47 specs.		
Current inrush	2.5 x Max input current		
Power factor	> 0.98 @ full load and nominal line		
Harmonic distortion	THD < 13%, PWHB < 22% (refer to EN 61000-3-12)		
Line interruption	Designed to meet SEMI F47-0706, 53, 58, S14 at nominal input voltages		
Input leakage current	< 2.5 mA (Note for fixed condition 3rd edition leakage = 5 mA)		
Power switch	Front panel power switch provided		
Input protection	Internal fuse (not user serviceable)		
Input overvoltage protection	Up to 115% of nominal input shall not damage unit		
Phase imbalance	≤ 5%		
Rack parallel	Up to 6 racks (144 KW)		
Efficiency	> 90% @ 3P 380 Vac full load > 91% @ 3P 480 Vac full load	> 91% @ 3P 240 Vac full load > 90% @ 3P 208 Vac 3P full load	> 90% @ 3P 600 Vac full load
Standby voltage	5 V		
Standby regulation	4.75 - 5.25 V		
Standby max current	1 A		

Note 1: Digital Ethernet UDP, RS485, CAN or Ethernet TC/IP with PowerPro Connect Module option. Command protocol is patterned to PMBus specification using a proprietary transaction protocol.

ARTESYN[™]
 An Advanced Energy Company

Total Harmonic Distortion Comparison

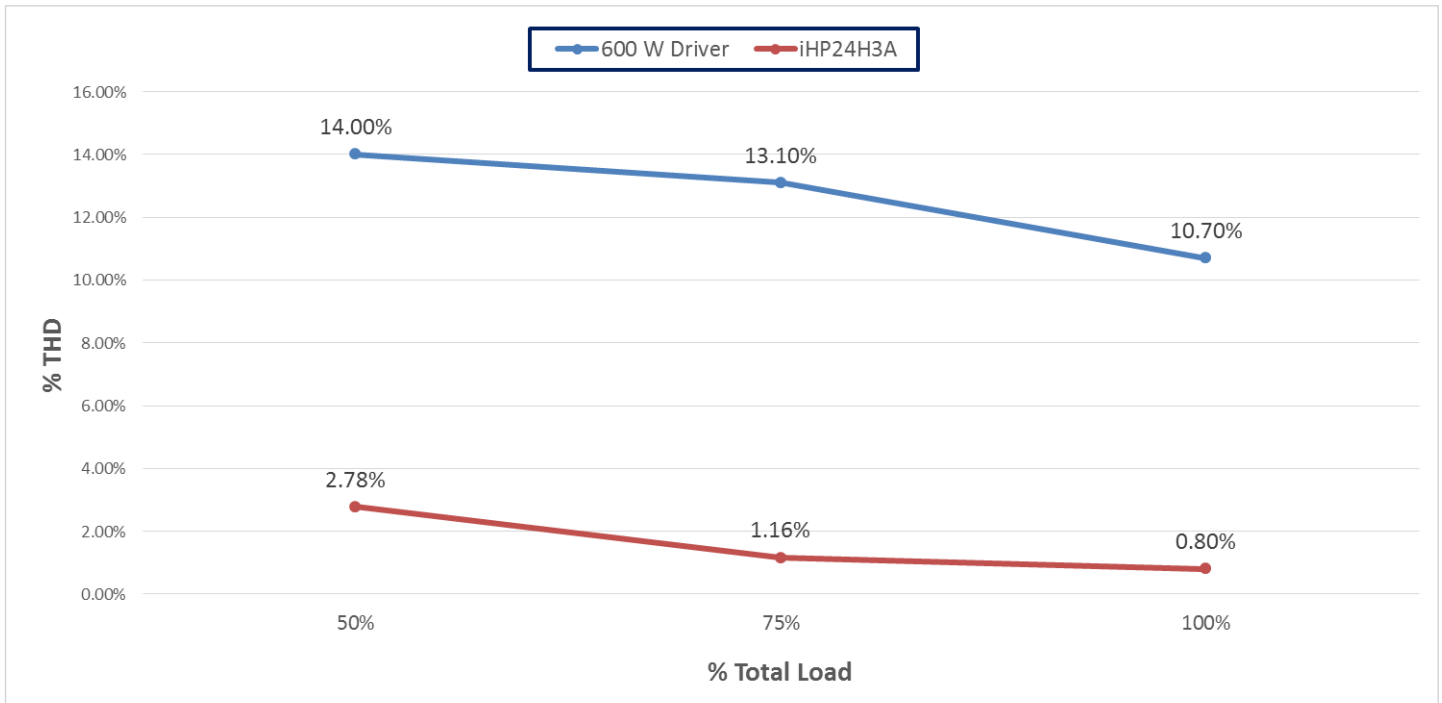

% Load	600 W Driver	iHP24H3A
50%	14.00%	2.78%
75%	13.10%	1.16%
100%	10.70%	0.80%

Notes:

1. 600 W driver data is taken from published datasheet.
2. iHP24H3A model data was captured at a nominal input of 480V 3-Phase at room ambient.
3. The input voltage of 277VAC is the single phase equivalent used when operating on 2 phases of a 480V 3-Phase utility service.

Safety Table

Model Number	Model Code	Module Nominal Voltage	Safety Compliance	Maximum Total Voltage Allowed
73-936-0012	SL	≤ 48 V	Medical 2MOPP*	300 V
73-936-0024	SQ		Medical 2MOOP**, ITE	400 V
73-936-0048	SW			
73-936-0080	S8	≥ 80 V	Medical 2MOPP	600 V
73-936-0125	S1		Medical 2MOOP	800 V
73-936-0200	SA		Medical 2MOOP	800 V
73-936-0250	S2		ITE	1000 V

Note: * -2MOPP or 2 × MOPP (Means of Patient Protection)
 ** -2MOOP or 2 × MOOP (Means of Operator Protection)

iHP12 Electrical Specifications

Input Parameter	19" Rack 12 KW strapped as 1-phase 200/220/230/240 Vac Nominal (iHP12L1A)	Type: 19" Rack 12 KW strapped as 3-phase 200/208/240 Vac Nominal (iHP12L3A)	Type: 19" Rack 12 KW strapped as 3-phase 380/480 Vac Nominal (iHP12H3A)
Input range	180 Vac to 264 Vac (Nominal rating 200/220/230/240 Vac)	180 Vac to 264 Vac (Nominal rating 200/208/240 Vac)	342 Vac to 528 Vac (Nominal rating 380/480 Vac)
Number of phases	1-phase 3-wire total (2-phase and 1 protective earth ground)	3-phase (Wye or Delta) 4-wire total (3-phase and 1 protective earth ground)	
Frequency	47-63 Hz		
Phase detection	NA	Loss of phase will inhibit unit off. Housekeeping/comms must continue with phase loss.	
Max current/phase	75 A @ 180 Vac	44 A @ 180 Vac	23 A @ 342 Vac 19 A @ 432 Vac
Undervoltage detection	Nominal input locked on at turn-on. Undervoltage shutdown at 15% below nominal. Turn-on at 12% below nominal. Not to interfere with SEMI F47 specs.		
Current inrush	2.5 x Max input current		
Power factor	> 0.99 @ full load and nominal line	> 0.98 @ full load and nominal line	
Harmonic distortion	THD < 3.5%, PWHD < 22% (refer to EN 61000-3-12)		
Line interruption	Designed to meet SEMI F47-0706, 53, 58, S14 at nominal input voltages		
Input leakage current	< 1.25 mA		< 2.5 mA
Power switch	Front panel power switch provided		
Input protection	Internal fuse (not user serviceable)		
Input overvoltage protection	Up to 115% of nominal input shall not damage unit		
Phase imbalance	NA	≤ 5%	≤ 5%
Rack parallel	Up to 6 racks (72 KW)		
Efficiency	> 91% @ 1P 240 Vac full load > 90% @ 1P 208 Vac/200 Vac full load	> 91% @ 3P 240 Vac full load > 90% @ 3P 208 Vac/200 Vac full load	> 90% @ 3P 380 Vac full load > 91% @ 3P 480 Vac full load
Standby voltage	5 V		
Standby regulation	4.75 - 5.25 V		
Standby max current	1 A		

EMC/Immunity

Parameter	All Models (Unless otherwise specified)
ESD	EN61000-4-2 (IEC1000-4-2)
Fast Transients	EN61000-4-4 (IEC1000-4-4)
Surge Immunity	EN61000-4-5 (IEC1000-4-5)
Conducted Immunity	EN61000-4-6 (IEC1000-4-6)
Radiated Immunity	EN61000-4-3 (IEC1000-4-3)
Power Frequency Magnetic Field	EN61000-4-8
Voltage Dips, Short Interruptions and Voltage Variations	EN 61000-4-34
Conducted Emission	EN55011, FCC CFR 47, Part 15, Subpart B
Radiated Emission	EN55011, FCC CFR 47, Part 15, Subpart B

Electromagnetic Compatibility/Input Transient

Category	Standard	Frequency	Level/Limits	PSU Performance Criteria ¹
Radiated Emissions ³	EN 55011/CISPR11	30 M - 1 GHz	Class A	5 dB Margin
	FCC CFR 47, Part 15, Subpart B	30 M - 1 GHz >1 GHz (see standard)	Class A	5 dB Margin
Conducted Emissions ³	EN 55011/CISPR11	150 k - 30 MHz	Class A	5 dB Margin
Power Line Harmonics ²	EN 61000-3-12	See standard	See standard	
Voltage Fluctuations ²	EN 61000-3-11	See standard	See standard	
Radiated Immunity	EN 61000-4-3	80 M - 2 GHz	10 V/meter	A
ESD	EN 61000-4-2		8 KV contact, 15 KV Air	A
Electrical Fast Transient	EN 61000-4-4		+/- 4 KV	A
Surge AC	EN 61000-4-5		2 KV DM, 2 KV CM	A
	IEEE C62.41		2 KV DM, 2 KV CM 6 KV, CM & DM	A Fail Safe
Conducted Susceptibility	EN 61000-4-6	150 KHz - 80 MHz	10 Vrms	A
Voltage Dips and Sags ²	EN 61000-4-34 SEMI F47	>95% reduction for >30% reduction for >95% reduction for 20% reduction for 30% reduction for 50% reduction for 60% reduction for	10 mS	A
			500 mS	A
			500 mS	C
			5000 mS	A
			500 mS	A
			200 mS	A
200 mS	B			

Notes:

¹ Performance Criteria as defined by EN 300 386 V1.3.3² Applies to AC power supplies only.³ Conducted and radiated emissions are measured using a typical set-up. In an actual end system, additional EMI filters may be required.

OUTPUT – General Specs

Parameter								
MODULE CODE	SL	SQ	ST	SW	S8	S1	SA	S2
# Outputs	1	1	1	1	1	1	1	1
Nominal O/P (V)	12.0 V	24.0 V	32.0 V	48.0 V	80.0 V	125.0 V	200.0 V	250.0 V
Max Power (W)	2400 W	2880 W	2880 W	3000 W	3000 W	3000 W	3000 W	3000 W
O/P Current Range (A)	0.0 A - 200 A	0.0 A - 120 A	0.0 A - 90 A	0.0 A - 62.5 A	0.0 A - 37.5 A	0.0 A - 24 A	0.0 A - 15.0 A	0.0 A - 12 A
Power Density (W/cu-in)	32.5	39.0	39.0	40.6	40.6	40.6	39	40.6
Efficiency (%)	93.5	93.5	93.5	93.5	93.5	93.5	93.5	93.5
Module Input Voltage	400 V							
Module Operating Temp	-0 °C to +65 °C; Baseplate Temp TBD							
Series Operation	250 V modules can be connected in series up to 800 V for Medical and 1000 V for ITE							
Parallel Operation	Up to 8 modules can be paralleled in 1 rack, with up to 6 racks connected in parallel. Single Wire Parallel connection will be provided as part of configuration							

OUTPUT – General Specs

Parameter		
MODULE CODE	TW	T3
# Outputs	1	1
Nominal O/P (V)	50 V	300 V
Max Power (W)	12000 W	12000 W
O/P Current Range (A)	0 -270 A	0 -50 A
Power Density (W/cu-in)	TBA	TBA
Efficiency (%)	93.2	94
Module Input Voltage	395V ± 5V	
Module Operating Temp	0°C to +65°C	
Series Operation	No series operation offering	
Parallel Operation	Up to two (2) modules can be paralleled in one (1) rack, with up to six (6) racks connected in parallel. Single Wire Parallel connection will be provided as part of configuration.	

OUTPUT – Module in Voltage Source Mode

Voltage Source								
MODULE CODE	SL	SQ	ST	SW	S8	S1	SA	S2
Nominal Output (V)	12	24	32	48	80	125	200	250
Setting Range (V)	0.6 V - 14.4 V	1.2 V - 28.8 V	1.6 V - 38.4 V	2.4 V - 57.6 V	4.0 V - 96.0 V	6.25 V - 150.0 V	10.0 V - 240.0 V	12.5 V - 300.0 V
Low Frequency RMS Ripple (mV)	24	48	64	96	160	250	500	500
Line Regulation (mV)	12	24	32	48	80	125	200	250
Load Regulation (mV)	24	48	64	96	160	250	400	500
P-P Ripple (mV)	60	120	160	240	400	625	1250	1250
Drift (Temp Stability)	±0.05% of I _{out} Rated over 8 hours, after 30 minute warm up, constant Line, Load and Temp							
Temp Coefficient (PPM/°C)	200							
Pgm Accuracy (mV)	Digital: 0.1% of Nominal Output Voltage; Analog: 1.0% of Nominal Output Voltage							
Pgm Resolution (mV)	SL=TBD; SQ=1; SW=2; S8=8; S1=6; S2=21							
Meas Accuracy (mV)	0.2% + 0.2% of Nominal Output Voltage							
Meas Resolution	SL=TBD; SQ=1; SW=2; S8=8; S1=6; S2=21							
Transient Response	Max 5.0% deviation from current set point must recover within 1mS for a 50% step load.							
Current Sense Method	Internal Shunt; External Shunt can be used for better temperature stability.							

OUTPUT – Module in Voltage Source Mode

Voltage Source		
MODULE CODE	TW	T3
Nominal Output (V)	50	300
Setting Range (V)	2.5 -60	15.0 -360
Low Frequency RMS Ripple (mV)	100	600
Line Regulation (mV)	50	300
Load Regulation (mV)	100	600
P-P Ripple (mV)	250	1500
Drift (Temp Stability)	±0.05% of V _{out} rated over 8 hours, constant line and load.	
Temp Coefficient (PPM/°C)	200	
Pgm Accuracy (mV)	Digital: 0.1% of Nominal Output Voltage / Analog: 1.0% of Nominal Output Voltage	
Pgm Resolution (mV)	2	TBA
Meas Accuracy (mV)	0.2% of Set Output + 0.2% of Nominal Output Voltage	
Meas Resolution	TBA	
Transient Response	Recovery time of 1mS (See Section 5.4.2 for the transient conditions)	
Current Sense Method		

OUTPUT – Module in Current Source Mode

Current Source - Programmable load compensation available for resistive and inductive loads; capacitive load applications; and LED drive applications

MODULE CODE	SL	SQ	ST	SW	S8	S1	SA	S2
Nominal Output (V)	12	24	32	48	80	125	200	250
Setting Range (A)	0.0 A - 200 A	0.0 A - 120 A	0.0 A - 90 A	0.0 A - 62.5 A	0.0 A - 37.5 A	0.0 A - 24 A	0.0 A - 15 A	0.0 A - 12 A
RMS Ripple (mA)	200	120	90	62.5	37.5	24	15	12
Line Regulation (mA)	200	120	90	125	93.75	48	50	24
Load Regulation (mA)	800	480	375	250	150	96	56	48
P-P Ripple (mA)	N/A							
Drift (Temp Stability)	±0.05% of I _{out} Rated over 8 hours, after 30 minute warm up, constant Line, Load and Temp							
Temp Co-efficient (PPM/°C)	SL, SQ = 300 PPM; All other modules are 200 PPM. Temp Co-efficient at rack level is [Temp Co-efficient (module level)] + [4500 PPM of I _{out} -max]							
Pgm Accuracy (A)	0.7% digital, 1.3% analog of rated output max							
Pgm Resolution (mA)	79.2	26.4		13.2	10	5.2	2.6	2.6
Meas Accuracy	0.7% + 0.7% of Rated Output Max							
Meas Resolution	79.2	26.4		13.2	10	5.2	2.6	2.6
Transient Response	0-63% output current change in 7.5 mSec, residual value 1%, settling time 35 mSec							
Current Sense Method	Internal Shunt / External Shunt							

OUTPUT – Module in Current Source Mode

Current Source -Programmable load compensation available for resistive and inductive loads; capacitive load applications; and LED drive applications

MODULE CODE	TW	T3
Nominal Output (V)	50	300
Setting Range (A)	0 -270	0 -50
RMS Ripple (mA)	270	50
*Line Regulation (mA)	270	100
*Load Regulation (mA)	1200	200
Pgm Resolution (mA)	20	TBA
Meas Resolution (mA)	TBA	TBA
*Pgm Accuracy (A)	Digital: 0.7% of Rated Output Max / Analog: 1.3% of Rated Output Max (1% to 100% O/P Current adjustability)	
*Meas Accuracy	0.7% + 0.7% of Rated Output Max	
*Drift (Temp Stability)	±0.05% of Iout-max over 8 hours, constant line and load.	
Temp Coefficient – Module Level (PPM of Iout-max / °C)	300	300
Temp Coefficient – Rack Level	[Temp Coefficient (module level)] + [4500ppm of Iout-max]	
Current Overshoot-Undershoot	+/- 5% of Iout-max (See Section 5.4.2 for the transient conditions)	
**Transient Response Time	Recovery time of 35mS (See Section 5.4.2 for the transient conditions)	
Current Sense Method	Internal Shunt	

Environmental Specifications

Operating Conditions	ALL MODELS (Unless Otherwise Specified)
Operating Temperature	0 °C to +50 °C at 100% rated load.
Storage Temperature	-40 °C to +85 °C. For Liquid Cooled models, liquid must be drained before storage
Operating Humidity	20% - 90% non condensing
Storage Humidity	10% - 95% non condensing
Operating Altitude	Up to 9,842 feet above sea level (3,000 meters)
Storage Altitude	Up to 30,000 feet above sea level (9,144 meters)
Vibration	Operating Sinusoidal Vibration MIL-STD-810G Method 528 Procedure I (Type 1): NEBS Office Vibration Environment, Alternate Procedure Operating Random Vibration: IPC-9592B Class 1 Non-Operating Vibration (Packaged): IPC-9592B Class 1; MIL-STD-810G, Method 514.6, Procedure 1, Category 7, Table 514.6C-VII General Exposure
Shock	MIL-STD-810G Method 516.6 Procedures I, II, IV, VI
Shipping and Handling	NSTA for <100 lbs; MIL-STD-2073-1 >100 lbs
Cooling and Audible Noise	<65 dBA with 80% load @ 30 °C at nominal input voltage with Smart Fan algorithm to be optimized based on module and rack thermal sensors. When modules are inhibited via software control, the fan speed is reduced to idle and acoustic noise is <46 dBA. With modules off via front panel switch fans are at idle for 1 min, and off for 9 min.
Ingress Protection	Fan Cooled = IP20
Pollution Degree	2
RoHS Compliance	Yes

Module and Marking Detail

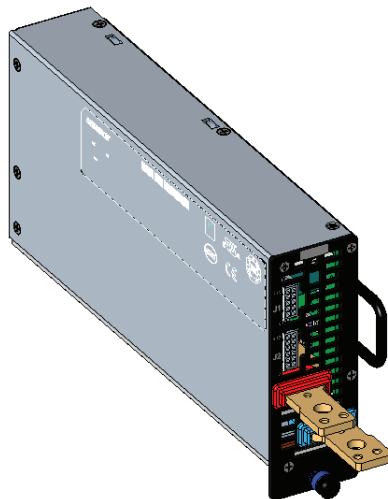

Standard Markings

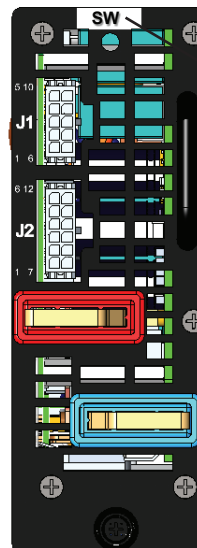

Module Code Label

Ordering Information

CASE CODE		MODULE CODES		PARALLEL/SERIES CASE CODE		CONF CODE	MOD CODE
iHP**XYA-		-XYZ* (x4/x8)		-XX-**		-X	-XXX
Case Decoder	iHP**XYA	Module Decoder	XVZ	First Digit	Second Digit	Blank = Ship as a kit	Factory Assigned
** = Case Power		X = Output Type		0 = None	0 = None	C = Ship Configured	
	12 = 12 KW 19" Rack		S = Single O/P (1-Slot)	1 = Slot 1&2	P = Parallel	Any other Alpha Character = Special set-up configuration	
	24 = 24 KW 19" Rack			2 = Slot 2&3	S = Series		
	24S = 24KW 19" Rack Short		T = Single O/P (3-Slot)	3 = Slot 2&3	1 = Combo 2 P/S		
X = Voltage Range		V = Nominal Voltage		4 = Slot 4&5	2 = Combo 2 S/P		
	L = Low Range*180-264		A = 200V	5 = Slot 5&6	3 = Combo 3 P/P/S		
	H = High Range 342-528		B = Future	6 = Slot 6&7	4 = Combo 3 P/S/P		
	C = Canadian 540-660		C = Future	7 = Slot 7&8	5 = Combo 3 P/S/S		
Y = Input Phase			D = Future	8 = Slot 1,2&3	6 = Combo 3 S/P/P		
	1 = Single Phase		L = 12 V	9 = Slot 1,2,3&4	7 = Combo 3 S/P/S		
	3 = 3-Phase		Q = 24 V	A = Slot 1,2,3,4&5	8 = Combo 3 S/S/P		
Z = Cooling			T = 32 V	B = Slot 1,2,3,4,5&6	9 = Combo 4 P/P/P/S		
	A = Air Cooled		W = 48 V	C = Slot 1,2,3,4,5,6&7	A = Combo 4 P/P/S/P		
			8 = 80 V	D = Slot 1,2,3,4,5,6,7&8	B = Combo 4 P/P/S/S		
A = Accessory Options			1 = 125 V	E = Slot 1&2; 3&4	C = Combo 4 P/S/P/P		
	Blank = Full control		2 = 250 V	F = Slot 1&2; 3&4; 5&6	D = Combo 4 P/S/P/S		
	1-9 = Future		3 = 300 V (12 KW ONLY)	G = Slot 1&2; 3&4; 5&6; 7&8	E = Combo 4 P/S/S/P		
			5 = 500 V (12 KW ONLY)	H = Slot 1,2&3; 4&5	F = Combo 4 P/S/S/S		
			9 = 825 V (12 KW ONLY)	J = Slot 1,2&3; 4&5; 6&7	G = Combo 4 S/P/P/P		
		Z=Mode	Blank = Standard	K = Slot 1,2&3; 4,5&6	H = Combo 4 S/P/P/S		
			P = Precision	L = Slot 1,2&3; 4,5&6; 7&8	J = Combo 4 S/P/S/P		
				M = Slot 1,2,3&4; 5&6	K = Combo 4 S/P/S/S		
				N = Slot 1,2,3&4; 5&6; 7&8	L = Combo 4 S/S/P/P		
				P = Slot 1,2,3&4; 5,6&7	M = Combo 4 S/S/P/S		
				R = Slot 1,2,3&4; 5,6,7&8	N = Combo 4 S/S/S/P		
				S = Slot 1,2,3,4&5; 6&7			
				T = Slot 1,2,3,4&5; 6,7&8			
				U = Slot 1,2,3,4,5&6; 7&8			
				Z=Special Defined by MOD Code			
				-** is allowed for secondary series/parallel code			
				1 = Groups 1&2	P = Parallel		
				8 = Groups 1,2&3	S = Series		
				9 = Groups 1,2,3&4	1 = Combo 2 P/S		
				E = Groups 1&2; 3&4	2 = Combo 2 S/P		

*Lowest possible input for the 24 kW version is 187.5 Vac

MODEL NUMBER SHORTCUT

For repeated like modules in parallel or series, instead of listing all the same modules separated by a "-", you can simply list the module once and then follow by the number of times it repeats enclosed in parenthesis.

For example:

iHP24H3A-SW-SW-SW-SW-SW-S8-S8-00

would become:

iHP24H3A-SW(6)-S8(2)-00

Part Number Information

Rack/Module	Description	Status
RACK		
73-958-0001	19" 12KW Case High Line 3-Phase Air (iHP12H3A)	Released
73-958-0001L	19" 12KW Case Low Line 3-Phase Air (iHP12L3A)	Released
73-958-0001S	19" 12KW Case Low Line 1-Phase Air (iHP12L1A)	Released
73-959-0001	19" 24KW Case High Line 3-Phase Air (iHP24H3A)	Released
73-959-0001L	19" 24KW Case Low Line 3-Phase Air (iHP24L3A)	Released
73-959-0001Z	19" 24KW Case 600V Canadian 3-Ph Y Air (iHP24C3A)	Released
73-969-0001	19" 24KW SHORT Case High Line 3-Phase Air (iHP24SH3A)	Coming Soon
73-969-0001L	19" 24KW SHORT Case Low Line 3-Phase Air (iHP24SL3A)	Coming Soon
3KW MODULES		
73-936-0012	12V 2400W Output Module (SL)	Released
73-936-0024	24V 2880W Output Module (SQ)	Released
73-936-0032	32V 3000W Output Module (ST)	Released
73-936-0048	48V 3000W Output Module (SW)	Released
73-936-0080	80V 3000W Output Module (S8)	Released
73-936-0125	125V 3000W Output Module (S1)	Released
73-936-0200	200V 3000W Output Module (SA)	Released
73-936-0250	250V 3000W Output Module (S2)	Released
12KW MODULES		
73-938-0050	50V 12000W Output Module (TW)	Released
73-938-0300	300V 12000W Output Module (T3)	Coming Soon
ACCESSORIES		
73-778-000A	PPCM (PowerPro Connect Module) Kit	Released
73-778-001	3-Phase Low Line Config Kit	Released
73-778-002	1 Phase Low Line Config Kit	Released
73-778-003	Module Accessory Kit	Released
73-778-004	2X Parallel Module Accessory Kit	Released
73-778-005	3X Parallel Module Accessory Kit	Released
73-778-006	4X Parallel Module Accessory Kit	Released
73-778-007	5X Parallel Module Accessory Kit	Released
73-778-008	6X Parallel Module Accessory Kit	Released
73-778-009	7X Parallel Module Accessory Kit	Released
73-778-010	8X Parallel Module Accessory Kit	Released
73-778-011	Initial Series Module Accessory Kit	Released
73-778-012	Subsequent Series Module Accessory Kit	Released
73-778-013	CAN/RS485 Terminator	Released
73-778-016	3-Phase High Line Config Kit	Released
73-778-022	Blank Panel 73-778-022	Released
73-778-023	iHP12 Isocomm board	Released
73-778-024	iHP24 Isocomm board	Released
73-778-026	iHP24 Cover Kit	Released
73-778-027	iHP12 Cover Kit	Released
73-778-029	iHP 8X IPROG Cable Assembly	Released
73-778-030	iHP 4X IPROG Cable Assembly	Released

Model	Weight
73-959-0001 iHP24	36.0 KG
73-959-0001Z iHP24C	35.0 KG
73-958-0001 iHP12	22.2 KG
73-936-0012 Module 3KW	2.2 KG
All other 3KW Module	2.0 KG
73-938-0050 Module 12KW	5.95 KG

Case Specs - Outline Detail

Front Panel Standard Markings
(Standard for both 12 KW and 24 KW)

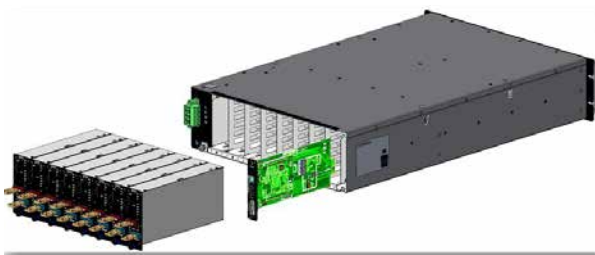
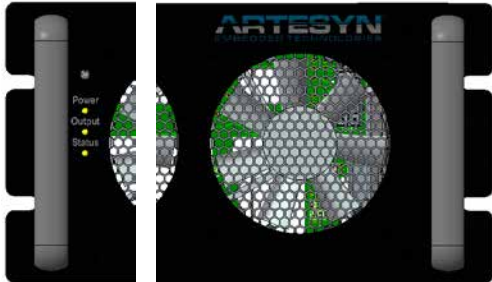

Input and Comms Standard Markings

View of iHP24L/H and iHP12L/H shown on top, iHP24C shown on bottom. Comms interface is horizontal on the iHP12L/H. See mechanical drawings for more details.

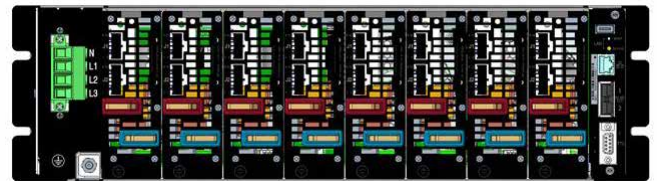
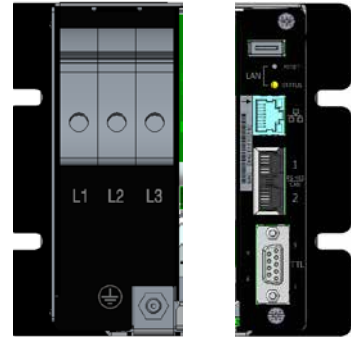

Module Specs - Outline Detail

Module J1 Signals

Pin #	Function	Function	Pin #
5	4-20mA_IPROG	SYS_M_FAULT#	10
4	0-5V_IPROG	SYS_M_ENABLE#	9
3	0-10V_IPROG	SYS_RTN	8
2	0-5V_VPROG	SYS_M_INHIBIT	7
1	0-10V_VPROG	4-20mA_VPROG	6

Module J2 Signals

Pin #	Function	Function	Pin #
6	NOT CONNECTED	ISHARE	12
5	IMON	VMON	11
4	D_RTN	ISHARE	10
3	EXT_ISENSE+	EXT_ISENSE-	9
2	D_RTN	V_SNS-	8
1	V_SNS+	D_RTN	7

J1 mating housing Molex Micro-fit MPN: 43025-1000
 J2 mating housing Molex Micro-fit MPN: 43025-1200
 Crimp Terminal AWG 20-24
 Crimp Terminal Molex MPN: 43030-0002

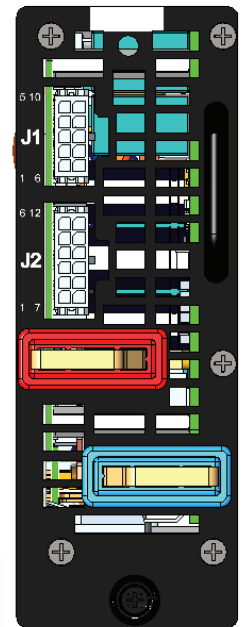
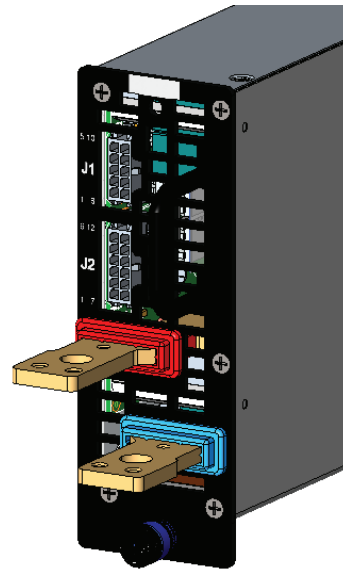

Condition	POWER LED	OUTPUT LED	SYSTEM STATUS LED
No AC	OFF	OFF	OFF
ISOCOM Start-Up Boot Load	BLINKING GREEN	OFF	OFF
SLEEP Mode (ON/OFF switch)	AMBER	OFF	OFF
Global Inhibit	SOLID GREEN	BLINKING GREEN	OFF
AC GOOD	SOLID GREEN	X	X
AC FAULT (OV, UV)	SOLID RED	OFF	SOLID RED
Output GOOD	SOLID GREEN	SOLID GREEN	SOLID GREEN
Auto-recoverable Fault (OTP)	SOLID GREEN	OFF	SOLID AMBER
Latching Fault (OVP, UVP) or Internal Fault	SOLID GREEN	OFF	SOLID RED
FAN FAIL	SOLID GREEN	OFF	BLINKING RED
BOOTLOADING	X	OFF	BLINKING AMBER

iHP24 Series - Mechanical Drawings

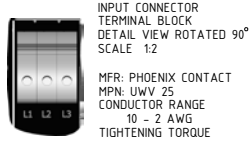

INPUT CONNECTOR
TERMINAL BLOCK
DETAIL VIEW ROTATED 90°
SCALE 1:2

MFR: PHOENIX CONTACT
MPN: UWV 25
CONDUCTOR RANGE
10 - 2 AWG
TIGHTENING TORQUE
4.5 N-m MAX

- NOTE:
1. WEIGHT:
RACK STANDALONE, 35.4 Kg
RACK WITH 8 MODULES, 52.9 Kg
 2. REFER TO PRODUCT LABELS FOR SAFETY INFORMATION AND SPECIAL INSTRUCTIONS.
 3. REFER TO PRODUCT SPECIFICATION FOR OPERATIONAL ENVIRONMENT.
 4. DO NOT OBSTRUCT INLET AND OUTLETS.

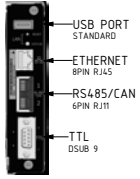
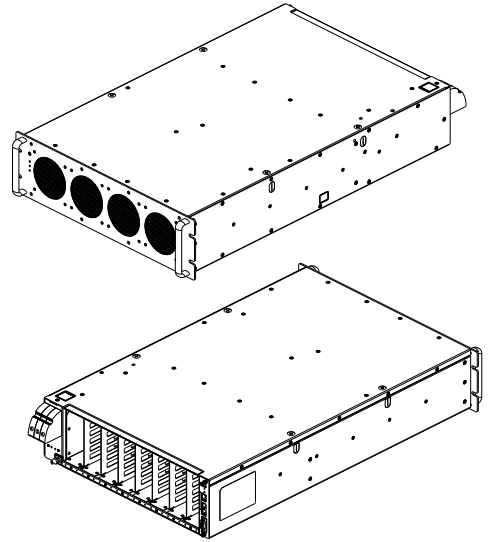
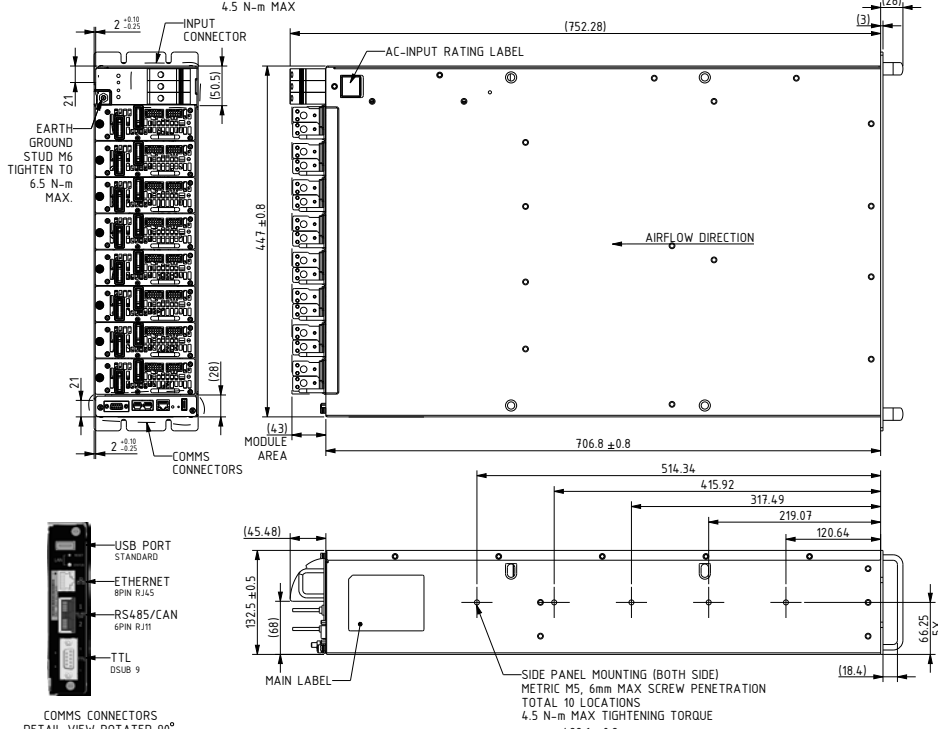

COMMS CONNECTORS
DETAIL VIEW ROTATED 90°
SCALE 1:2

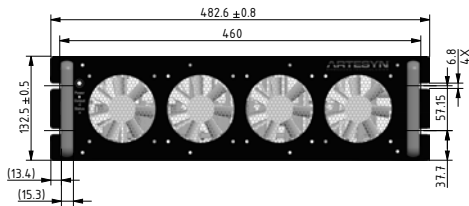

iHP Modules - Mechanical Drawings

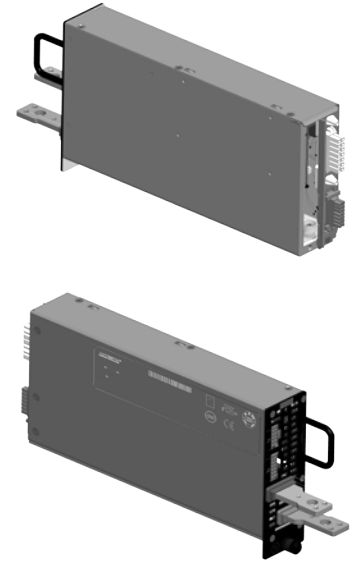
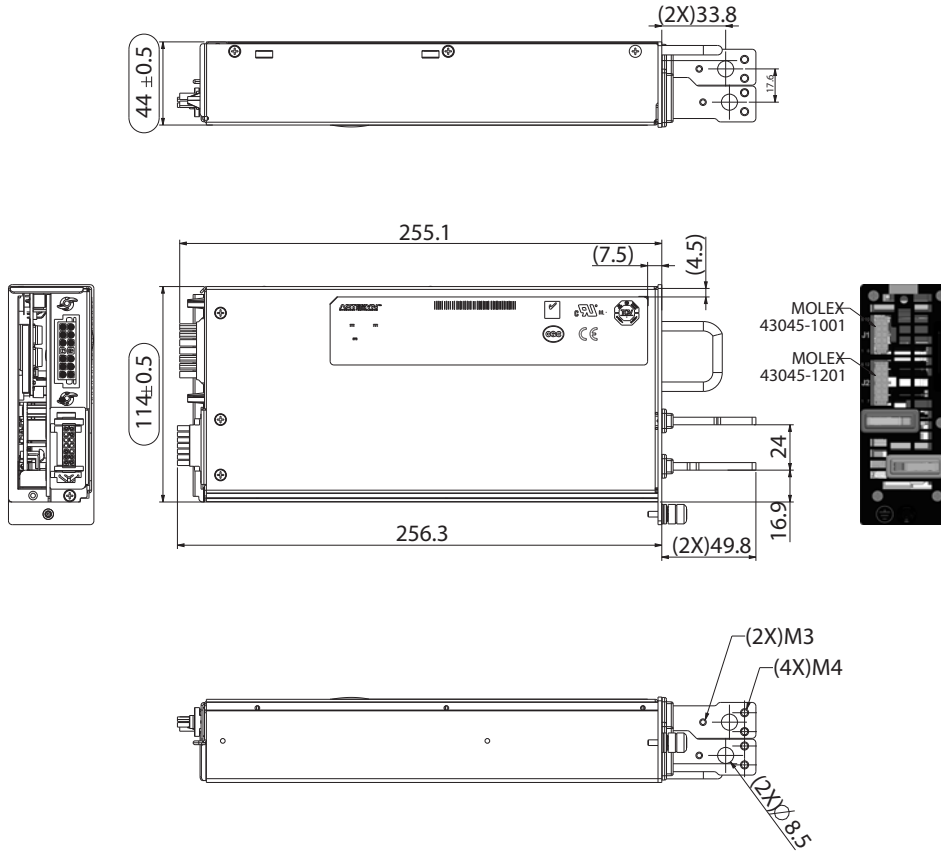

12KW Modules - Mechanical Drawings

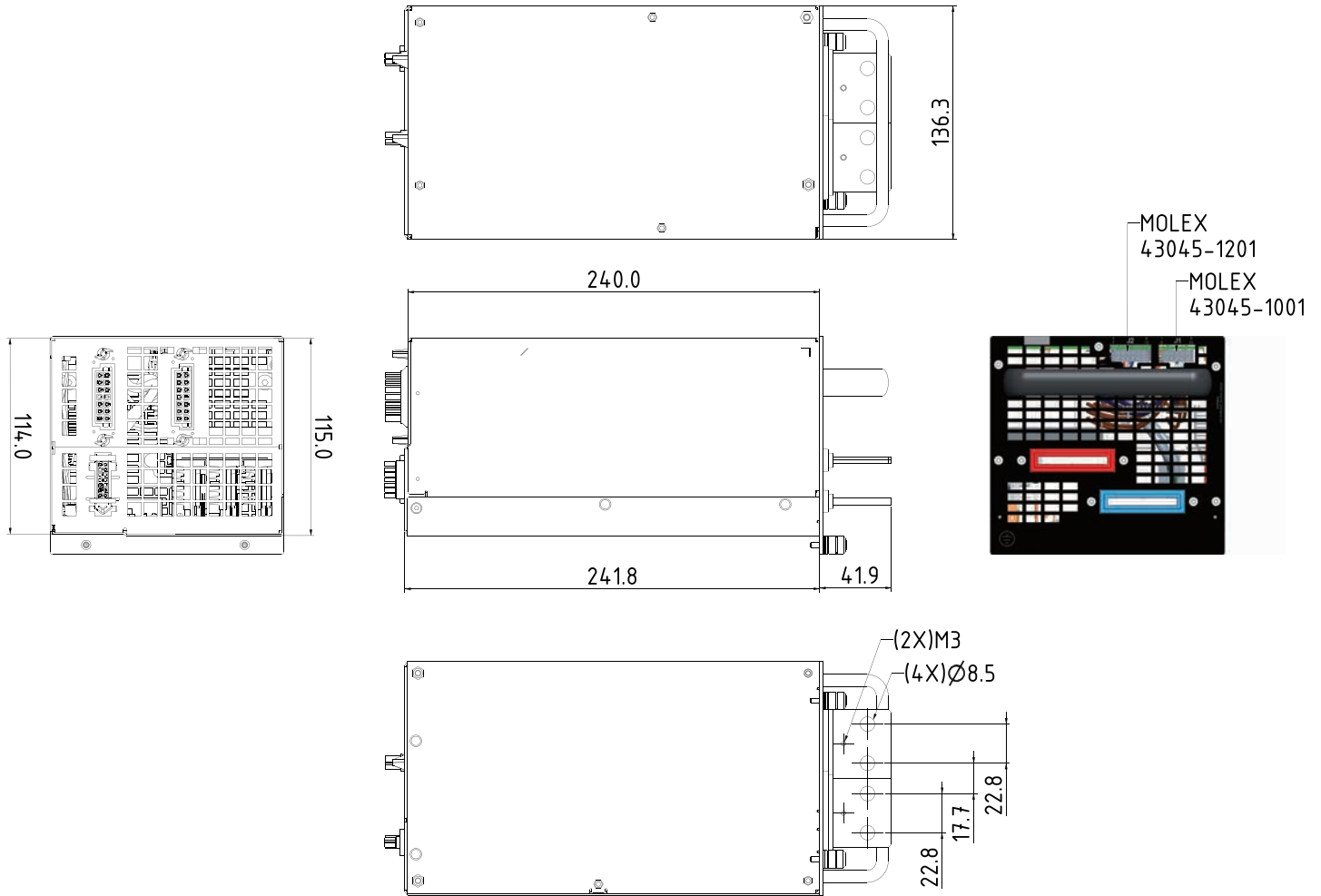

PowerPro Connect Module



POWERPRO

Part number: 73-778-000A

The PowerPro Connect Module (purchased separately) can provide standard Ethernet interface via the internet to a cloud- and dashboard-based user-configurable GUI.

WORLDWIDE OFFICES

Americas

2900 South Diablo Way
Suite B100
Tempe, AZ 85282, USA
+1 888 412 7832

Europe (UK)

Ground Floor Offices, Barberry House
4 Harbour Buildings, Waterfront West
Brierley Hill, West Midlands
DY5 1LN, UK
+44 (0) 1384 842 211

Asia (HK)

14/F, Lu Plaza
2 Wing Yip Street
Kwun Tong, Kowloon
Hong Kong
+852 2176 3333

ARTESYN[™]
An Advanced Energy Company

www.artesyn.com

Artesyn Embedded Technologies, Artesyn Embedded Power, Artesyn, and all Artesyn related logos are trademarks and service marks of Artesyn Embedded Technologies, Inc. All other names and logos referred to are trade names, trademarks, or registered trademarks of their respective owners. Specifications are subject to change without notice. © 2020 Artesyn Embedded Technologies, Inc. All rights reserved. For full legal terms and conditions, please visit www.artesyn.com/legal.

For more information: www.artesyn.com
For support: productsupport.ep@artesyn.com