





SPECIFICATION FOR APPROVAL

TO : _____

REF. No. _____

CUSTOMER APPROVED	APPROVED DATE	CHECKED DATE	PREPARED DATE
		 	

MODEL No. AS12024MB25A100 P.S. _____

DESCRIPTION: DC FAN (RoHS) REV. B

ID No. _____

THIS OFFER IS MADE ACCORDING TO YOUR CURRENT INQUIRY.
UNLESS OTHERWISE REVISED, THIS SPECIFICATION WILL BE FINAL FOR
ALL FUTURE PRODUCTION OF ORDERS FROM YOUR RESPECTED COMPANY

KINDLY STUDY IN DETAILS AND RETURN TO US THE DUPLICATE DULY
SIGNED AS YOUR CONFIRMATION OF SAME.



ADDA CORPORATION

DATA - SHEET

Engineering

Printed On: 16/01/14

BRUSHLESS AXIAL COOLING FANS

Customer	:		Ref: (RoHS)
Adda Model No	:	AS12024MB25A100	
Samples attached	:	Piece(s),	
Safety Approval	:	UL,CUL,TUV,CE	TUV:EN 60950-1:2006+A11+A1+A12 UL:UL507 CE:EN 61000-6-1:2007 EN 61000-6-3:2007+A1

Specifications

ITEM	SPECIFICATION / CONDITION			
DIMENSIONS	:	120x120x25	mm	
BEARING TYPE	:	BALL		
RATED VOLTAGE	:	24	VDC	
OPERATING VOLTAGE RANGE	:	21.6	VDC	— 26.4 VDC
START-UP VOLTAGE	:	17	VDC	, NORMAL
REAL CURRENT	:	0.43	Amp	
REAL POWER	:	10.32	Watt	
RATED CURRENT	:	0.46	Amp	+ 10 %MAX
RATED POWER	:	11.04	Watt	
RATED SPEED	:	3400	RPM	± 10 %
(IN FREE AIR AT RATED VOLTAGE)				
AIR FLOW	:	150.766	CFM	(min.: 135.689 CFM)
AIR FLOW	:	4.266	CMM	(min.: 3.839 CMM)
(IN FREE AIR AT RATED VOLTAGE)				
STATIC AIR PRESSURE	:	0.387	Inch H ₂ O	(min.: 0.313 Inch H ₂ O)
STATIC AIR PRESSURE	:	9.829	mm H ₂ O	(min.: 7.961 mm H ₂ O)
(IN FREE AIR AT RATED VOLTAGE)				
NOISE LEVEL	:	54.7	dB (A)	(max.: 58.7 dB(A))
MOTOR PROTECTION	:	BY	IC	
POLARITY PROTECTION	:	YES		
CONNECTION LEAD TYPE	:	WIRE, AWG#	24	
LIFE EXPECTANCY	:	70000	Hours	at 40°C / 65% RH
NET WEIGHT	:	220	Gram.	
PACKING	:	60	pcs.	Per Export Carton.

Unless otherwise stated, the relative humidity is 65%, and the temperature is 25°C for the standard testing.

Should you have any doubt, please refer to the environmental conditions specified in the acknowledgement document.



SPECIFICATION

1.0 SCOPE

- 1.1 If the information or other related document is inconsistent with this acknowledgement document, please refer to the acknowledge document.
- 1.2 This documentation defines the mechanical & electrical characteristics of DC brushless fans.
- 1.3 The specification of this product is described in details in the acknowledgement document. No guarantee is given to our product under the use of over specifications.
- 1.4 For any change or amendment to the specifications, such change will be noticed in writing beforehand.
- 1.5 If the product is used on the MIS system, please specify the specification in the purchase order.

2.0 MATERIAL

- 2.1 Frame : UL94V-0 Glass Filled polyester (P.B.T)
- 2.2 Fan Blade : UL94V-0 Glass Filled polyester (P.B.T)
- 2.3 Bearing Sys. : () Sleeve, oil impregnated.
(V) Two Ball Bearing
() One Ball one Sleeve
() Hypro Bearing
() FDB Bearing
- 2.4 RoHS : (V) YES
HF : () YES

3.0 DIMENSIONS & CONSTRUCTION

All dimensions, Direction of rotation and air flow were specified as per drawing attached.

4.0 CHARACTERISTICS & DEFINITION

- 4.1 All rated characteristics were specified as per data sheet enclosed.
- 4.2 Rated Current : Rated Current shall be measured after 3 minutes of continuous rotation at rated voltage.
- 4.3 Rated Speed : Rated Speed shall be measured after 3 minutes of continuous rotation at rated voltage.
- 4.4 Start Voltage : The voltage which is able to start the fan to operate by suddenly switching ' ON ' .
- 4.5 Input Power : Input Power shall be measured after 3 minutes of continuous rotation at rated voltage.
- 4.6 Locked Rotor Current : Locked current shall be measured within one minute of rotor locked, after 3 minutes of continuous rotation at rated voltage in clean air.
- 4.7 Air Flow & Static Pressure : The air flow data and static pressures should be determined in accordance with AMCA-210 standard in a doublechamber testing with intake – side measurement.
- 4.8 Noise Level : The measurement of noise level is carried out with reference to CNS8753 in an anechoic chamber with the microphone positioned 1 meter from the air intake. Testing fan shall be hung in clean air .

NOISE LEVEL MEASUREMENT

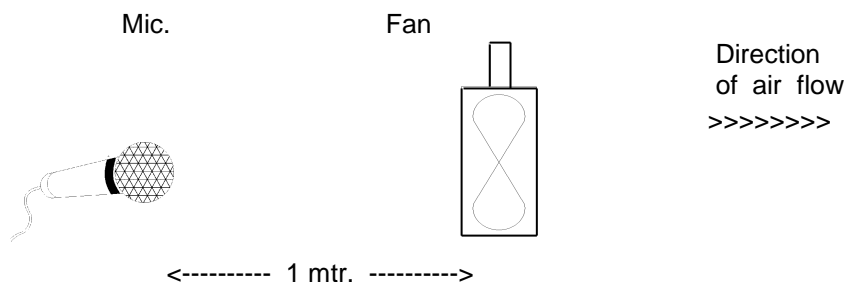

SPECIFICATION

5.0 MECHANICAL INSPECTION

5.1 Rotation Direction

Counterclockwise when look into impeller side.

5.2 Protection

All fans have integrated protection against locked rotor condition so that there will be no damage to winding or any electronic component.

Restarting is automatic as soon as any constraint to rotation has been released.

As fan placed at dead angle position, and the switch was changed from off to on. Restarting was automatic normal as soon as and proved that this fan is good fan.

5.3 Locked Rotor Protection

No damage shall be found after 72 hours continuously at condition of rotation locked.

Restarting is automatic as soon as constraint to running has been released.

5.4 Avoid the damage, check the correct voltage and proper polarity before connecting with power.

5.5 Free Drop Shock

In minimum package condition, the fan should withstand drops on any three faces from a height of 30cm onto a wood board of 10mm thick.

5.6 Please do not stick a grease and/or an oil to the fan housing or blade which may have a harmful influence by a chemical reaction at high humidity.

5.7 If the fan is reinstalled, please pay special attention to the noise due to the vibration (or resonance).

5.8 During the testing of the fan, please make sure the finger guard is used for safety.

6.0 ELECTRICAL INSPECTION

6.1 Insulation Resistance

Not less than 10M ohm between housing and positive end of lead wire (red) at 500V DC.

6.2 Dielectric Strength

No damage should be found at 500 VAC for 60 seconds, measured with 1mA trip current between housing and positive end of lead wire.

6.3 Life Expectancy

The continuous duty life at given temperature after which, 90% of testing units shall still be running.

6.4 While the fan is running, do not intentionally lock the fan for a long time since the overheating of the motor produced by the long-time locking will damage the fan.

7.0 ENVIRONMENTAL

7.1 Improper use such as disassembling the fan, being covered with dust, or dipping the fan in water that results in defects is not covered in the warranty. Do not use the fan in the environment with corrosive air or liquid.

7.2 Operating Temperature / Humidity

-10°C to +70°C at humidity 65%+/-20% RH.

7.3 Storage Temperature

All function shall be normal after 500 hours storage at -40°C to +70 °C with a 24 hour recovery period at room temperature.

7.4 Humidity

After 96 hours, 95% RH, 40+/-2°C per MIL-STD-202F, method 103B humidity test, the measured data on insulation resistance and dielectric strength shall meet the specificaiton.

7.5 Do not place or store the fan in the environment with high/low temperature/humidity. Do not store the fan for over 6 months; even if the fan is stored in room temperature for over 6 months, the fan may have the electric current leakage.



SPECIFICATION

8.0 REMARKS

- 8.1 Material and construction are subject to change without advance notice. The changes should be within specification.
- 8.2 All fans shall meet the quality inspection under sampling plan MIL-STD-105E as follow:

Critical	0.25%
Major	1.00%
Minor	2.50%

9.0 OUTLINE STYLING & DIMENSIONS

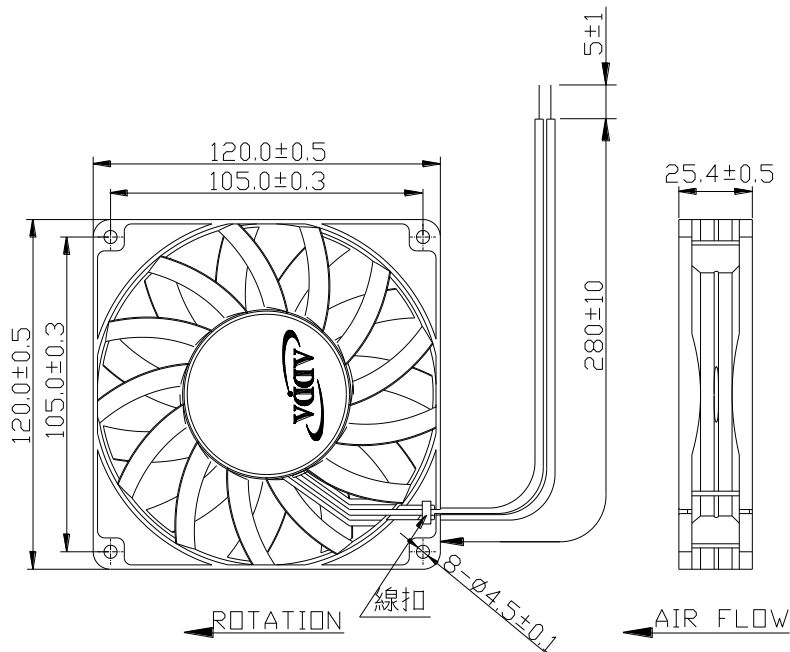

LEAD WIRES : UL 1007, AWG24 , L = 280±10 mm
Red = positive ; Black = negative.



10.0 Notes:

- 10.1 Please do not touch and push Fan Blade with fingers or others, fan blade and ball bearings may be damaged and it causes noise defect.
- 10.2 Do not carry the fan by its lead wires.
- 10.3 If the fan does not have the polarity protection function, the connection of the colored wires should be red + red, and black + black, or else the fan will be damaged in no time.
- 10.4 For the models without reverse connection of polarity protection, please do not connect the lead wire in reverse
- 10.5 Please don't install this fan in series with 2x voltage inputs. For example, if a single fan rated at 12V, then don't install two of them in series with 24V input.
- 10.6 Every specific fan is designed for its certain application (project). Therefore, if you want to use this fan in other application (project), please inform ADDA first so that we can confirm whether there is any issue which might be incurred from the reason of this different application (project) or not.
- 10.7 The "Life Expectancy" of this fan has not been evaluated for use in combination with any end application. Therefore, the Life Expectancy in the Test Reports(L10 and MTTF Report) that relate to this fan is for reference only and shall not construe any kind of warranty of ADDA to the life of any specific fan, either expressed or implied.
- 10.8 The period of product warranty, unless otherwise agreed by ADDA in written, shall be 12 months starting from the date of production.



Adda Fan Performance Test Report

Static Pressure
mmH₂O inH₂O

Fan Model : AS12024MB25A100

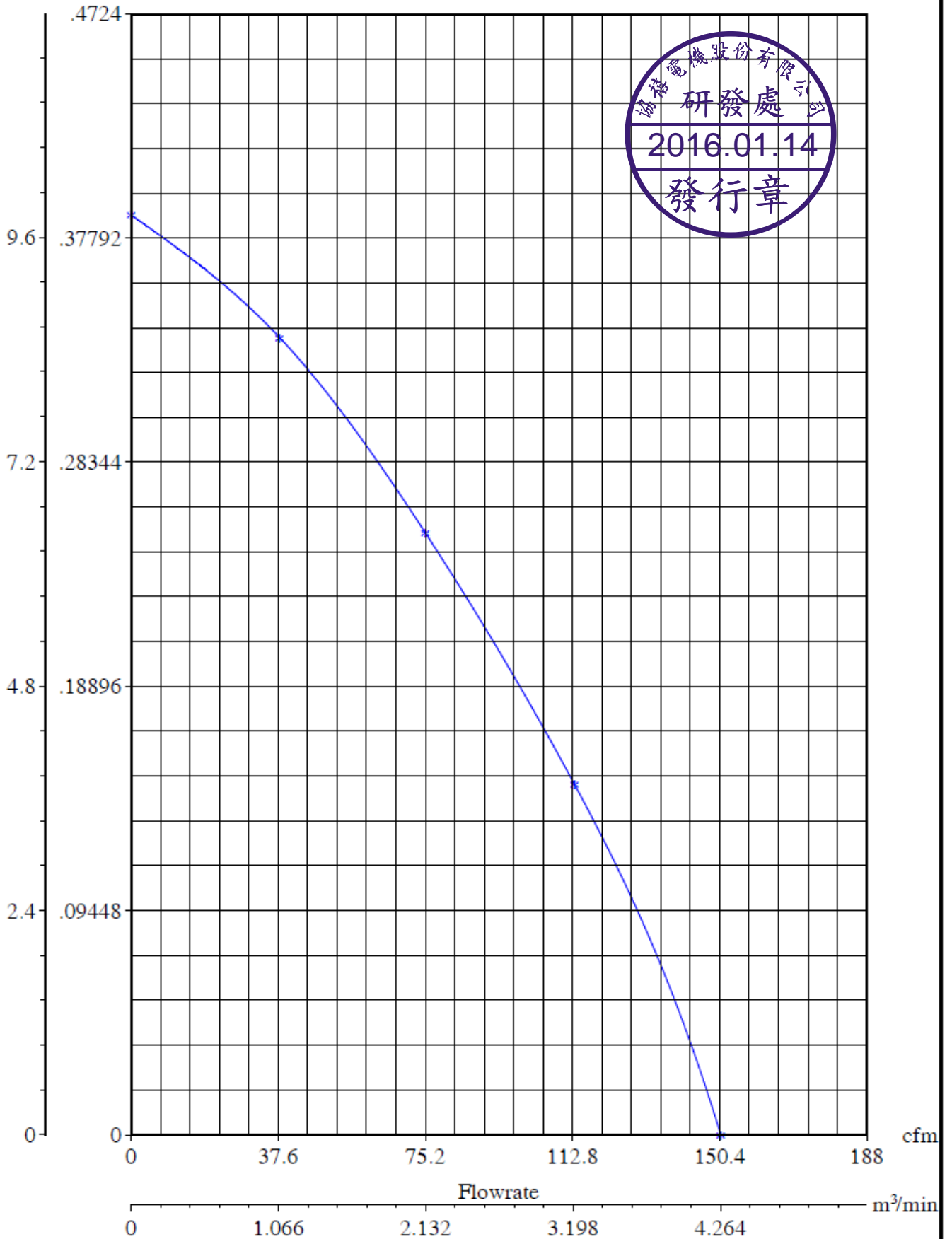

Approver :

Examiner :

Tester :

Zertifikat

Certificate



Zertifikat Nr. Certificate No. R 50111797
Blatt Page 0006

Ihr Zeichen Client Reference 12051227
Unser Zeichen Our Reference ZTW2-HCY- 11011138 003
Ausstellungsdatum Date of Issue 13.03.2008 (day/mo/yr)

Genehmigungsinhaber License Holder Adda Corporation
6, East Section, Industry 6 Road
Pingtung City 900
Taiwan, R.O.C.
Fertigungsstätte Manufacturing Plant Adda Corporation
6, East Section, Industry 6 Road
Pingtung City 900
Taiwan, R.O.C.

Prüfzeichen Test Mark Geprüft nach Tested acc. to
EN 60950-1:2001+A11



Zertifiziertes Produkt (Geräteidentifikation)
Certified Product (Product Identification)

Lizenzentgelte - Einheit
License Fee - Unit

Ventilator (DC Fan)

Wie Blatt (As Page) 01
Ergänzung (Addition)

Bezeichnung : a) AG08012Y1Y2257Y300
(Type Designation) b) AG08012HY2257Y301
c) AS120Z1Z2B25AZ300
Y1 steht für (stands for): M, L oder (or) D
Y2 steht für (stands for): B, S oder (or) X
Y3 steht für (stands for): 0 oder (or) 6
Z1 steht für (stands for): 12, 24 oder (or) 48
Z2 steht für (stands for): U, H, M oder (or) L
Z3 steht für (stands for): 1, 3, 9 oder (or) B
Nennspannung : siehe Anlage
(Rated Voltage) (see Appendix)
Nennstrom : siehe Anlage
(Rated Current) (see Appendix)



1
1
1
1
1
1
1
1



9

ANLAGE (Appendix): 1.2

Dem Zertifikat liegt unsere Prüf- und Zertifizierungsordnung zugrunde.
Das Produkt entspricht den o.g. Anforderungen, die Herstellung wird überwacht.
This certificate is based on our Testing and Certification Regulation. The product fulfills above mentioned requirements, the production is subject to surveillance.

Zertifizierungsstelle

TÜV Rheinland Product Safety GmbH, Am Grauen Stein, D-51105 Köln
Tel.: (+49/221)8 06 - 13 71 e-mail: cert-validity@de.tuv.com
Fax: (+49/221)8 06 - 39 35 http://www.tuv.com/safety

Dipl.-Ing. B. Scheirer

Zertifikat

Certificate



Zertifikat Nr. *Certificate No.*
R 50111797

Blatt *Page*
0064

Ihr Zeichen <i>Client Reference</i>	Unser Zeichen <i>Our Reference</i>	Ausstellungsdatum	<i>Date of Issue</i> (day/mo/yr)
12060494/ST160712	ZTW1-YML- 11011138 056	08.08.2012	

Genehmigungsinhaber *License Holder*
Adda Corporation
6, East Section, Industry 6 Road
Pingtung City 900
Taiwan, R.O.C.

Fertigungsstätte *Manufacturing Plant*
Adda Corporation
6, East Section, Industry 6 Road
Pingtung City 900
Taiwan, R.O.C.

Prüfzeichen *Test Mark*

Geprüft nach *Tested acc. to*
EN 60950-1:2006+A11+A1+A12

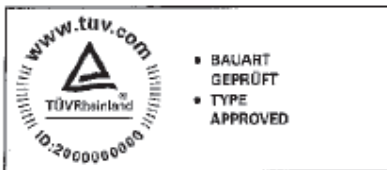

Zertifiziertes Produkt (Geräteidentifikation)
Certified Product (Product Identification)

Lizenzentgelte - Einheit
License Fee - Unit

Ventilator (DC Fan)

wie Blatt (as page) 01

Änderung
(Change)

Prüfgrundlage : siehe oben
(Test Requirement) (see above)



ANLAGE (Appendix): 1 - 1.51

Dem Zertifikat liegt unsere Prüf- und Zertifizierungsordnung zugrunde und es bestätigt die Konformität des Produktes mit den oben genannten Standards und Prüfgrundlagen. Zusätzliche Anforderungen in Ländern, in denen das Produkt in Verkehr gebracht werden soll, müssen zusätzlich betrachtet werden. Die Herstellung des zertifizierten Produktes wird überwacht.
This certificate is based on our Testing and Certification Regulation and states the conformity of the product with the standards and testing requirements as indicated above. Any additional requirements in countries where the product is going to be marketed have to be considered additionally. The manufacturing of the certified product is subject to surveillance.

TÜV Rheinland LGA Products GmbH - Tillystraße 2 - 90431 Nürnberg
Tel.: (+49/221)8 06 - 13 71 e-mail: cert-validity@dc.tuv.com
Fax: (+49/221)8 06 - 39 35 http://www.tuv.com/safety

Zertifizierungsstelle

