

Accessory 9071.99.0651

Description

Gas discharge tube 600 V (SEMPER)

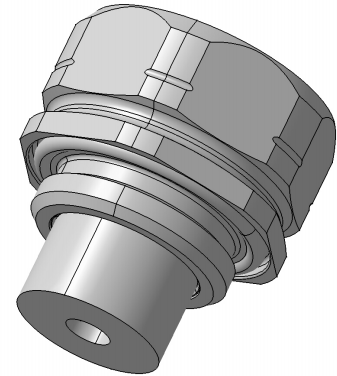

Technical Data

GDT unit for retrofit and replacement for series 3401 and 3402

- UL recognized component, UL File E153537

- DC voltage ≤ 48 V

- DC current ≤ 2.5 A

- Turn-off time:

20 s typically at 2.0 A and 25 °C ambient temperature

< 40 s typically below 1 A and 25 °C ambient temperature

- Recovery time:

7 s at 25 °C ambient temperature

- Operating temperature:

-40 °C to +85 °C (Lightning protection functionality)

-20 °C to +85 °C (SEMPER(TM) functionality)

(Specifications subject to change without notice)

Mechanical Data

Weight 0.0127 g

Environmental Data

Operating temperature -20 °C to +85 °C
2011/65/EU (RoHS - including compliant
2015/863 and 2017/2102)

Related Documents

Outline drawing DOU-00292087
Mounting instruction DOC-0000228888