

**SERIES:** PYBJ3 | **DESCRIPTION:** DC-DC CONVERTER

**FEATURES**

- 3W isolated output
- ultra-wide input voltage range
- single regulated output
- high efficiency up to 82%
- output short circuit, over current, over voltage protection
- 1500 Vdc isolation
- available with or without case
- EN62368 approved

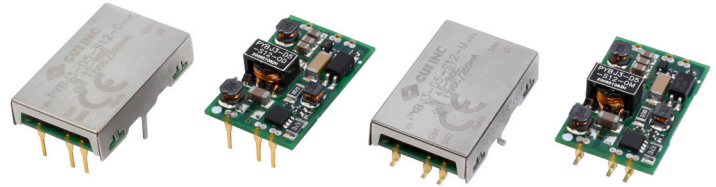

MODEL	input voltage		output voltage (Vdc)	output current		output power max (W)	ripple & noise max (mVp-p)	efficiency <sup>2</sup> typ (%)
	typ (Vdc)	range (Vdc)		min (mA)	max (mA)			
PYBJ3-D5-S5	5	4.5~9	5	0	600	3	100	72
PYBJ3-D5-S12	5	4.5~9	12	0	250	3	100	76
PYBJ3-D5-S15	5	4.5~9	15	0	200	3	100	77
PYBJ3-D5-S24	5	4.5~9	24	0	125	3	100	76
PYBJ3-D24-S3	24	9~36	3.3	0	600	2	100	72
PYBJ3-D24-S5	24	9~36	5	0	600	3	100	77
PYBJ3-D24-S12	24	9~36	12	0	250	3	100	81
PYBJ3-D24-S15	24	9~36	15	0	200	3	100	82
PYBJ3-D24-S24	24	9~36	24	0	125	3	100	81

Notes: 1. PYBJ3-Dxx-Sxx-x contains 4 types of products, include DIP package without case, DIP package with case, SMD package without case and SMD package with case.  
2. Efficiency is measured In nominal input voltage and rated output load.

**PART NUMBER KEY**

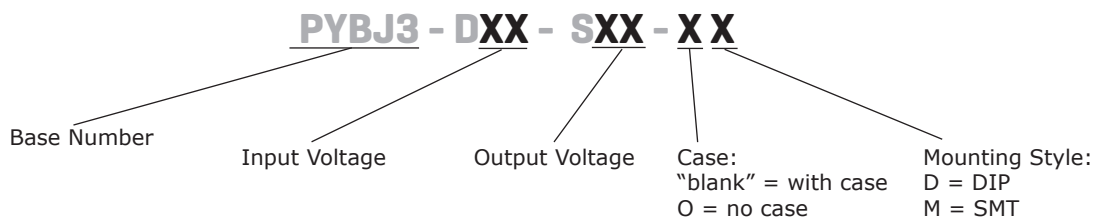

**INPUT**

parameter	conditions/description	min	typ	max	units
operating input voltage <sup>1</sup>	5 Vdc input models			12	Vdc
	24 Vdc input models			40	Vdc
start-up voltage	5 Vdc input models			4.5	Vdc
	24 Vdc input models			9	Vdc
surge voltage	5 Vdc input models for maximum of 1 second	-0.7		16	Vdc
	24 Vdc input models for maximum of 1 second	-0.7		50	Vdc
current	5 Vdc input models, full load			857	mA
	24 Vdc input models, full load			169	mA
filter	5 Vdc input models - LC filter 24 Vdc input models - C filter				
CTRL	module on: CTRL pulled low to GND (0~0.3 Vdc) module off: CTRL open or pulled high (2~12 Vdc) input current when switched off		5	10	mA

Notes: 1. Exceeding maximum input voltage may cause permanent damage.

**OUTPUT**

parameter	conditions/description	min	typ	max	units
maximum capacitive load	model				
	D5-S5			470	μF
	D5-S12			220	μF
	D5-S15			100	μF
	D5-S24			47	μF
	D24-S3			1000	μF
	D24-S5			1000	μF
	D24-S12			470	μF
	D24-S15			330	μF
D24-S24			100	μF	
voltage accuracy	0% ~ 100% load			±2	%
line regulation	input voltage variation from low to high at full load			±0.5	%
load regulation	5% ~ 100% load			±1	%
switching frequency	PWM mode		330		kHz
transient recovery time	25% load step change, nominal input voltage		300	500	μs
transient response deviation	25% load step change, nominal input voltage				
	3.3 Vdc output		±5	±10	%
	5 Vdc output		±5	±8	%
	other outputs		±3	±5	%
temperature coefficient	at full load			±0.3	%/°C
trim			±5		%

**PROTECTIONS**

parameter	conditions/description	min	typ	max	units
over voltage protection		110		160	%
over current protection		110	160	250	%
short circuit protection	output shutdown, auto recovery				

**SAFETY AND COMPLIANCE**

parameter	conditions/description	min	typ	max	units
isolation voltage	input to output for 1 minute at 5 mA	500			Vac
	input to case for 1 minute at 5 mA	500			Vac
	output to case for 1 minute at 5 mA	500			Vac
	input to output for 1 minute at 1 mA	1,500			Vdc
	input to case for 1 minute at 1 mA	1,500			Vdc
	output to case for 1 minute at 1 mA	1,500			Vdc
isolation resistance	input to output	100			MΩ
	input to case	100			MΩ
	output to case	100			MΩ
isolation capacitance	input to output, 100 kHz / 0.1 V		1,000		pF
safety approvals	EN 62368				
EMI/EMC	CISPR32/EN55032 class B (see Fig.3-2 for recommended circuit)				
ESD	IEC/EN61000-4-2 Contact ±6KV perf. criteria B				
radiated immunity	IEC/EN61000-4-3 10V/m perf. criteria A				
EFT/burst	IEC/EN61000-4-4 ±2KV (see Fig.3-1 for recommended circuit) perf. criteria B				
surge	IEC/EN61000-4-5 line to line ±2KV (see Fig.3-1 for recommended circuit) perf. criteria B				
conducted immunity	IEC/EN61000-4-6 3 Vr.m.s perf. criteria A				
MTBF	as per MIL-HDBK-217F, 25°C	1,000			K hours
RoHS	yes				

**ENVIRONMENTAL**

parameter	conditions/description	min	typ	max	units
operating temperature	see derating curve	-40		85	°C
storage temperature		-55		125	°C
storage humidity	non-condensing	5		95	%
vibration	10-55Hz			5	G

## MECHANICAL

parameter	conditions/description	min	typ	max	units
dimensions	DIP without case: 24.00 x 15.10 x 6.19 [0.944 x 0.594 x 0.243 inch]				mm
	DIP with case: 25.00 x 16.40 x 6.80 [0.984 x 0.645 x 0.267 inch]				mm
	SMT without case: 26.20 x 15.10 x 6.19 [1.031 x 0.594 x 0.243 inch]				mm
	SMT with case: 26.20 x 16.40 x 6.80 [1.031 x 0.645 x 0.267 inch]				mm
case material	aluminum alloy				
weight	DIP without case, SMT without case		2.2		g
	DIP with case, SMT with case		3.5		g

## MECHANICAL DRAWING (DIP WITHOUT CASE)

units: mm [inch]

tolerance:  $\pm 0.50[\pm 0.020]$

pin diameter tolerance:  $\pm 0.10[\pm 0.004]$

PIN Out	
PIN	Function
1	Vin
2	Ctrl
3	GND
4	0V
5	Trim
6	+Vo

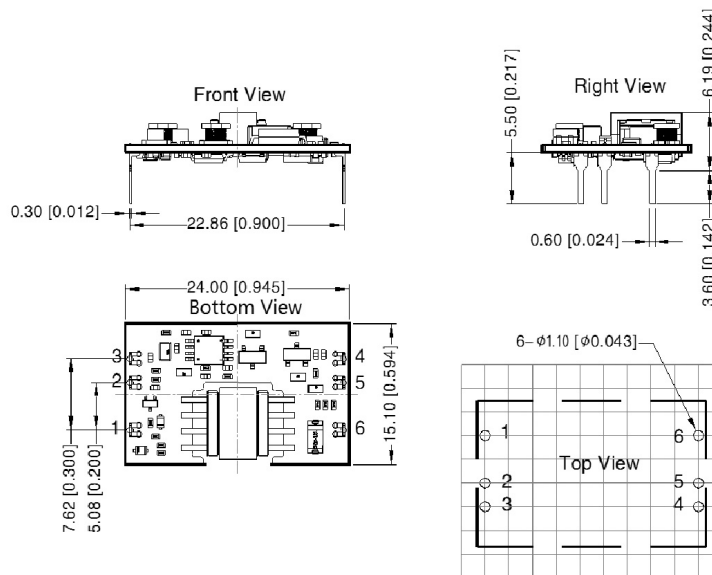

Note: Grid 2.54\*2.54mm

## MECHANICAL DRAWING (DIP WITH CASE)

units: mm [inch]

tolerance:  $\pm 0.50[\pm 0.020]$

pin diameter tolerance:  $\pm 0.10[\pm 0.004]$

PIN Out	
PIN	Function
1	Vin
2	Ctrl
3	GND
4	0V
5	Trim
6	+Vo

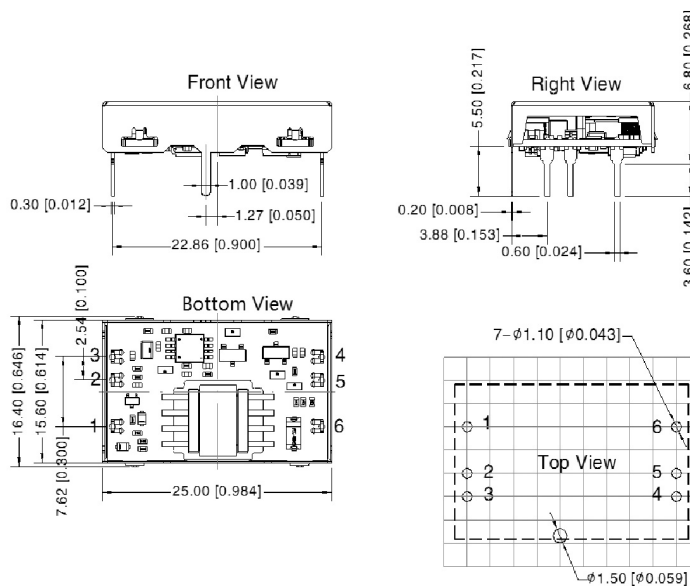

Note: Grid 2.54\*2.54mm

## MECHANICAL DRAWING (SMT WITHOUT CASE)

units: mm [inch]

tolerance:  $\pm 0.50$  [ $\pm 0.020$ ]

pin diameter tolerance:  $\pm 0.10$  [ $\pm 0.004$ ]

PIN Out	
PIN	Function
1	Vin
2	Ctrl
3	GND
4	0V
5	Trim
6	+Vo

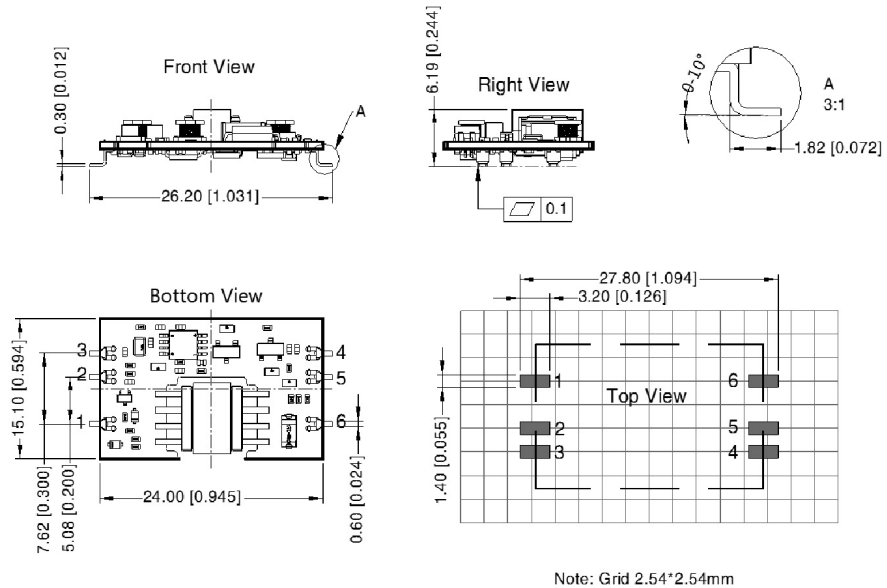

## MECHANICAL DRAWING (SMT WITH CASE)

units: mm [inch]

tolerance:  $\pm 0.50$  [ $\pm 0.020$ ]

pin diameter tolerance:  $\pm 0.10$  [ $\pm 0.004$ ]

PIN Out	
PIN	Function
1	Vin
2	Ctrl
3	GND
4	0V
5	Trim
6	+Vo

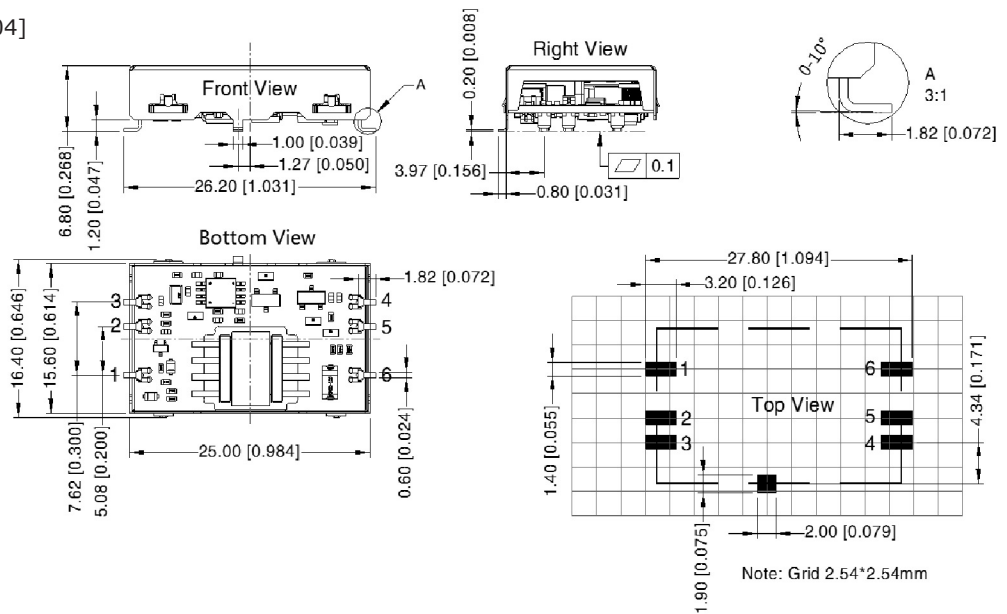

## DERATING CURVES

24V input models

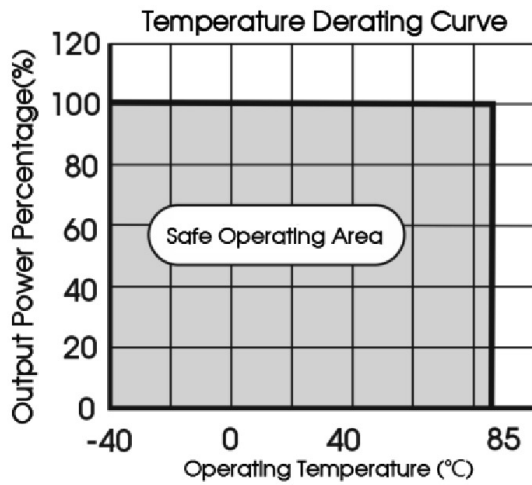

5V input models

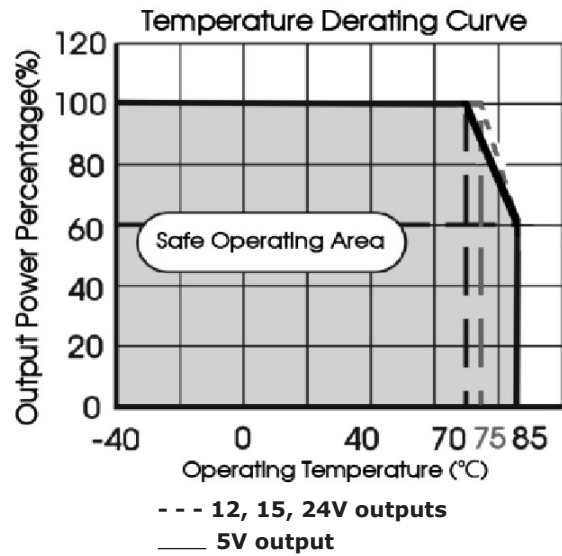

## APPLICATION CIRCUIT

All the DC-DC converters of this series are tested before delivery using the recommended circuit shown in Fig. 2. Input and/or output ripple can be further reduced by appropriately increasing the input & output capacitor values  $C_{in}$  and  $C_{out}$  and/or by selecting capacitors with a low ESR (equivalent series resistance). Also make sure that the capacitance is not exceeding the max. capacitive load value of the product.

Figure 1

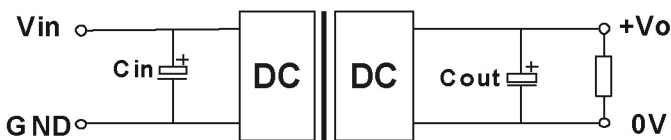

Table 1

Vout (Vdc)	Cin (μF)	Cout (μF)
3.3	10	100
5		
12		
15		
24		

## EMC RECOMMENDED CIRCUIT

Figure 2

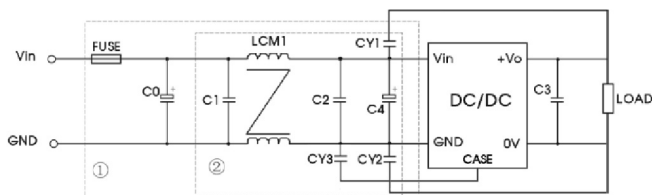

Table 2

Recommended External Circuit Components		
Vin (Vdc)	5	24
FUSE	choose according to actual input current	
C0	2200μF/35V	1000μF/50V
C1	4.7μF/50V	
C2	4.7μF/50V	
C4	100μF/50V	220μF/50V
C3	Refer to the Cout in Fig.2	
LCM1	2.2mH	
CY1/CY2/CY3	2.2nF/2kV	

## APPLICATION NOTES

Figure 3

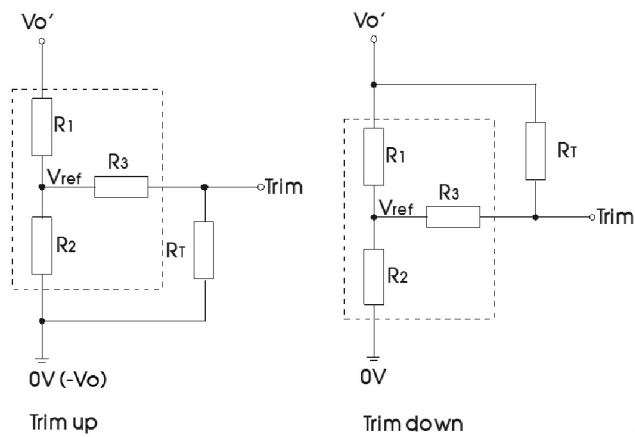

Table 3

Vout (Vdc)	R1 (kΩ)	R2 (kΩ)	R3 (kΩ)	Vref (V)
3.3	4.80	2.87	10	1.25
5	2.87	2.87	10	2.5
12	10.91	2.87	15	2.5
15	14.35	2.87	15	2.5
24	24.77	2.87	17.4	2.5

### Formula for trim resistor

$$\text{up: } R_T = \frac{a R_2}{R_2 - a} - R_3 \quad a = \frac{V_{ref}}{V_{o'} - V_{ref}} \cdot R_1$$

$$\text{down: } R_T = \frac{a R_1}{R_1 - a} - R_3 \quad a = \frac{V_{o'} - V_{ref}}{V_{ref}} \cdot R_2$$

Note: Value for R1, R2, R3, and Vref refer to Table 3  
 R<sub>T</sub>: Trim Resistor  
 a: User-defined parameter, no actual meanings  
 Vo': The trim up/down voltage

## REVISION HISTORY

---

rev.	description	date
1.0	initial release	07/16/2020

The revision history provided is for informational purposes only and is believed to be accurate.



**Headquarters**  
20050 SW 112th Ave.  
Tualatin, OR 97062  
**800.275.4899**

Fax 503.612.2383  
**cuicom**  
techsupport@cuicom

CUI offers a two (2) year limited warranty. Complete warranty information is listed on our website.

CUI reserves the right to make changes to the product at any time without notice. Information provided by CUI is believed to be accurate and reliable. However, no responsibility is assumed by CUI for its use, nor for any infringements of patents or other rights of third parties which may result from its use.

CUI products are not authorized or warranted for use as critical components in equipment that requires an extremely high level of reliability. A critical component is any component of a life support device or system whose failure to perform can be reasonably expected to cause the failure of the life support device or system, or to affect its safety or effectiveness.