

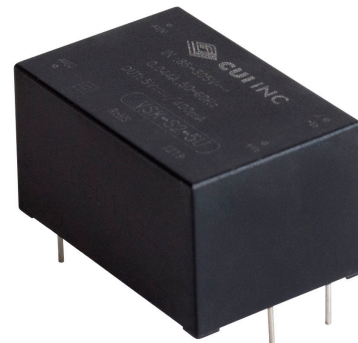

**SERIES:** VSK-S2 | **DESCRIPTION:** AC-DC POWER SUPPLY

**FEATURES**

- up to 2 W continuous power
- compact board mount design
- universal input (85~305 Vac / 120~430 Vdc)
- single output from 3.3~24 Vdc
- over current and short circuit protection
- UL/cUL and CE safety approvals
- efficiency up to 78%



| MODEL       | output voltage | output current | output power | ripple and noise <sup>1</sup> | efficiency |
|-------------|----------------|----------------|--------------|-------------------------------|------------|
|             | (Vdc)          | max (mA)       | max (W)      | max (mVp-p)                   | typ (%)    |
| VSK-S2-3R3U | 3.3            | 600            | 2            | 200                           | 65         |
| VSK-S2-5U   | 5              | 400            | 2            | 200                           | 70         |
| VSK-S2-9U   | 9              | 222            | 2            | 200                           | 72         |
| VSK-S2-12U  | 12             | 167            | 2            | 200                           | 76         |
| VSK-S2-15U  | 15             | 133            | 2            | 200                           | 76         |
| VSK-S2-24U  | 24             | 83             | 2            | 200                           | 78         |

Notes: 1. At full load 20 MHz bandwidth oscilloscope, see Test Configuration section.

**PART NUMBER KEY**



## INPUT

| parameter                 | conditions/description   | min | typ | max  | units |
|---------------------------|--------------------------|-----|-----|------|-------|
| voltage                   |                          | 85  |     | 305  | Vac   |
|                           |                          | 120 |     | 430  | Vdc   |
| frequency                 |                          | 47  |     | 63   | Hz    |
| current                   | at 115 Vac               |     |     | 55   | mA    |
|                           | at 230 Vac               |     |     | 31   | mA    |
| inrush current            | at 115 Vac<br>at 230 Vac |     | 7   |      | A     |
|                           |                          |     | 14  |      | A     |
| leakage current           |                          |     |     | 0.15 | mA    |
| no load power consumption |                          |     |     | 0.2  | W     |

## OUTPUT

| parameter               | conditions/description      | min | typ | max   | units |
|-------------------------|-----------------------------|-----|-----|-------|-------|
| maximum capacitive load | 3.3 and 5 Vdc output models |     |     | 4,000 | μF    |
|                         | 9 and 12 Vdc output models  |     |     | 2,200 | μF    |
|                         | 15 Vdc output model         |     |     | 1,000 | μF    |
|                         | 24 Vdc output model         |     |     | 680   | μF    |
| line regulation         | at full load                |     | ±2  |       | %     |
| load regulation         | at 10 ~ 100% load           |     | ±5  |       | %     |
| voltage accuracy        | 3.3 Vdc model               |     | ±6  |       | %     |
|                         | all other models            |     | ±5  |       | %     |
| switching frequency     |                             |     |     | 100   | kHz   |

## PROTECTIONS

| parameter                | conditions/description   | min | typ | max | units |
|--------------------------|--------------------------|-----|-----|-----|-------|
| over current protection  | auto restart             | 110 |     |     | %     |
| short circuit protection | continuous, auto restart |     |     |     |       |

## SAFETY & COMPLIANCE

| parameter                    | conditions/description  | min     | typ | max | units |
|------------------------------|---|---------|-----|-----|-------|
| isolation voltage            | input to output for 1 minute  | 3,000   |     |     | Vac   |
| safety approvals             | UL 60950-1  |         |     |     |       |
| safety class                 | class II  |         |     |     |       |
| conducted/radiated emissions | CISPR22/EN55022 Class B   |         |     |     |       |
| ESD                          | IEC/EN61000-4-2 class B, contact ±4kV, air ±8kV                         |         |     |     |       |
| radiated immunity            | IEC/EN61000-4-3 class A, 10V/m  |         |     |     |       |
| EFT/burst                    | IEC/EN61000-4-4 class B, ±2kV (external circuit required, see figure 3) |         |     |     |       |
| surge                        | IEC/EN61000-4-5 class B, ±2kV (external circuit required, see figure 3) |         |     |     |       |
| conducted immunity           | IEC/EN61000-4-6 class A, 10 Vr.m.s                                      |         |     |     |       |
| PFM                          | IEC/EN61000-4-8 class A, 10 A/m   |         |     |     |       |
| voltage dips & interruptions | IEC/EN61000-4-11 class B, 0%-70%  |         |     |     |       |
| MTBF                         | as per MIL-HDBK-217F, 25°C  | 300,000 |     |     | hours |
| RoHS                         | 2011/65/EU  |         |     |     |       |

## ENVIRONMENTAL

| parameter             | conditions/description | min | typ | max | units |
|-----------------------|------------------------|-----|-----|-----|-------|
| operating temperature | see derating curves    | -25 |     | 70  | °C    |
| storage temperature   |                        | -25 |     | 85  | °C    |
| operating humidity    | non-condensing         |     |     | 90  | %     |
| storage humidity      | non-condensing         |     |     | 95  | %     |

## DERATING/EFFICIENCY CURVES

Output power vs. ambient temperature  
(100~305 Vac; 140~430 Vdc)

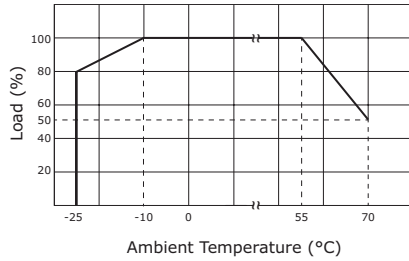

output power vs. input voltage  
(25°C)

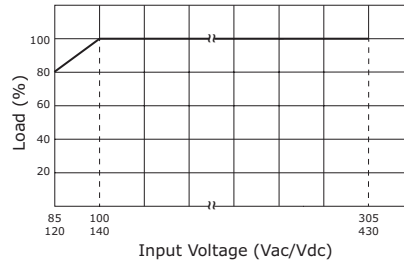

efficiency vs. output power  
(Vin=230 Vac)

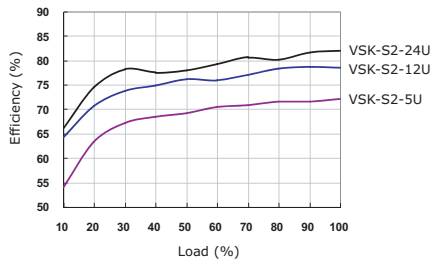

efficiency vs. input voltage  
(full load)

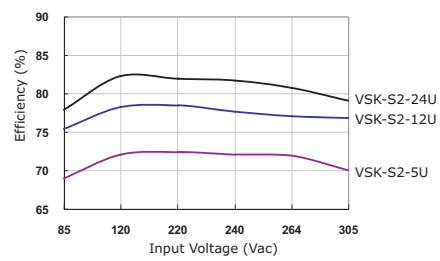

## MECHANICAL

| parameter     | conditions/description                             | min | typ | max | units |
|---------------|--|-----|-----|-----|-------|
| dimensions    | 33.70 x 22.20 x 18.00 (1.327 x 0.874 x 0.708 inch) |     |     |     | mm    |
| case material | UL94V-0  |     |     |     |       |
| weight        |  |     | 20  |     | g     |

## MECHANICAL DRAWING

units: mm [inches]  
tolerance: ±0.50 [±0.020]  
pin section tolerance: ±0.10 mm [±0.004]

| PIN CONNECTIONS |          |
|-----------------|----------|
| PIN             | FUNCTION |
| 1               | AC(N)    |
| 2               | AC(L)    |
| 3               | -Vo      |
| 4               | +Vo      |

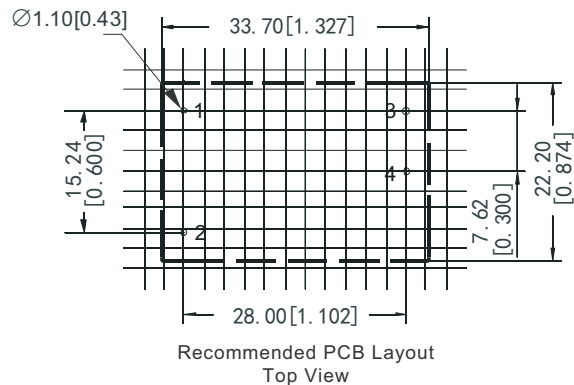
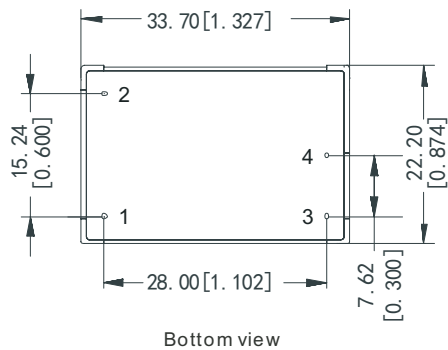
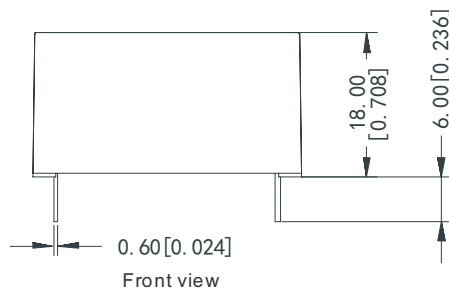

## TEST CONFIGURATION

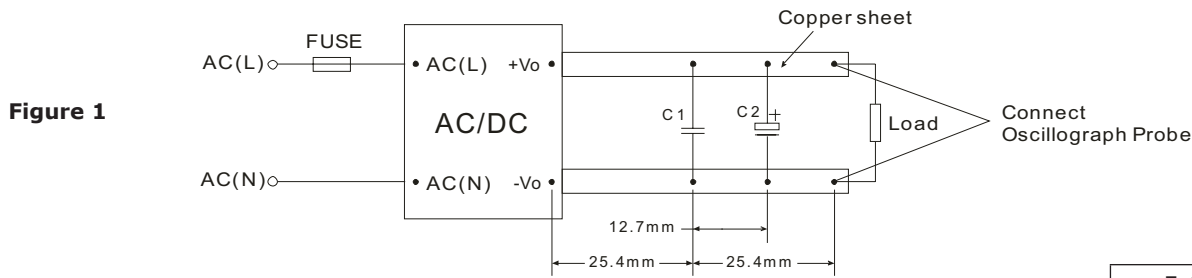

**Table 1**

| External components |                         |
|---------------------|-------------------------|
| C1                  | 1 $\mu$ F ceramic       |
| C2                  | 10 $\mu$ F electrolytic |

## TYPICAL APPLICATION CIRCUIT

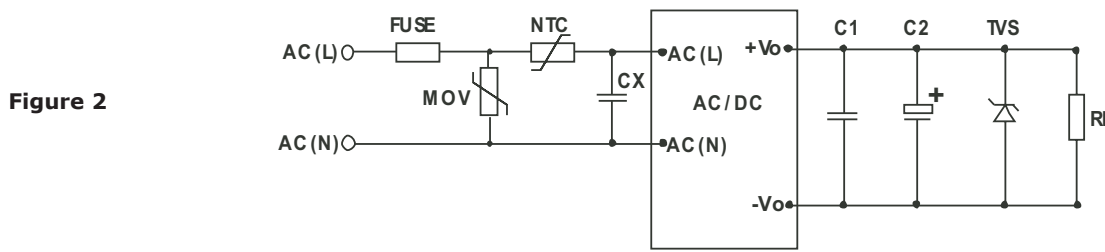

**Table 2**

| Recommended external circuit components |                    |         |        |                 |            |                    |       |                  |                 |                 |
|---|--------------------|---------|--------|-----------------|------------|--------------------|-------|------------------|-----------------|-----------------|
| Model                                   | FUSE               | MOV     | NTC    | R1              | CY3, CY4   | CX                 | LCM   | TVS <sup>1</sup> | C1 <sup>2</sup> | C2 <sup>3</sup> |
| VSK-S1-3R3U                             | 1A/300V, slow blow | S14K350 | 10D-11 | 47 $\Omega$ /3W | 2.2nF/400V | 0.4 $\mu$ F/305Vac | 10 mH | SMBJ7.0A         | 1 $\mu$ F/50V   | 220 $\mu$ F     |
| VSK-S1-5U                               | 1A/300V, slow blow | S14K350 | 10D-11 | 47 $\Omega$ /3W | 2.2nF/400V | 0.1 $\mu$ F/305Vac | 10 mH | SMBJ7.0A         | 1 $\mu$ F/50V   | 220 $\mu$ F     |
| VSK-S1-9U                               | 1A/300V, slow blow | S14K350 | 10D-11 | 47 $\Omega$ /3W | 2.2nF/400V | 0.1 $\mu$ F/305Vac | 10 mH | SMBJ12A          | 1 $\mu$ F/50V   | 120 $\mu$ F     |
| VSK-S1-12U                              | 1A/300V, slow blow | S14K350 | 10D-11 | 47 $\Omega$ /3W | 2.2nF/400V | 0.1 $\mu$ F/305Vac | 10 mH | SMBJ20A          | 1 $\mu$ F/50V   | 120 $\mu$ F     |
| VSK-S1-15U                              | 1A/300V, slow blow | S14K350 | 10D-11 | 47 $\Omega$ /3W | 2.2nF/400V | 0.1 $\mu$ F/305Vac | 10 mH | SMBJ20A          | 1 $\mu$ F/50V   | 120 $\mu$ F     |
| VSK-S1-24U                              | 1A/300V, slow blow | S14K350 | 10D-11 | 47 $\Omega$ /3W | 2.2nF/400V | 0.1 $\mu$ F/305Vac | 10 mH | SMBJ30A          | 1 $\mu$ F/50V   | 68 $\mu$ F      |

## EMC RECOMMENDED CIRCUIT

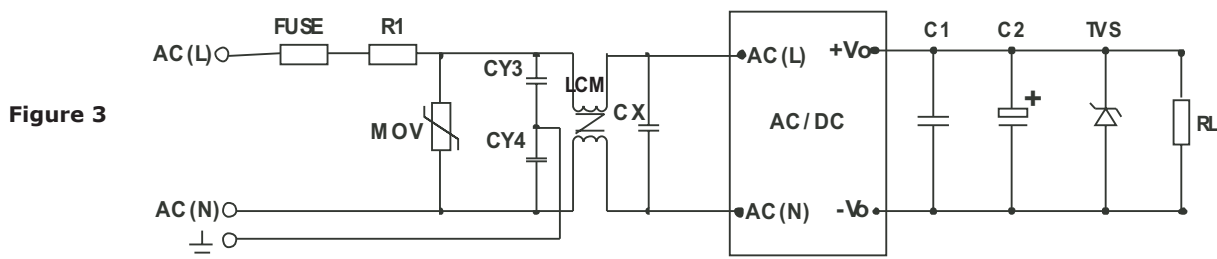

- Notes:
1. See Table 2 for EMC components.
  2. TVS is a recommended component to protect post-circuits if converter fails.
  3. C1 is a ceramic capacitor used to filter high frequency noise.
  4. C2 is an electrolytic capacitor. We recommend using high frequency and low impedance electrolytic capacitors. For capacitance and current of capacitor please refer to the manufacturer's datasheet. Voltage derating of capacitor should be 80% or above.
  5. All specifications are measured at rated input voltage, rated output load, TA=25°C, and humidity < 75% unless otherwise specified.

## REVISION HISTORY

| rev. | description                               | date       |
|------|---|------------|
| 1.0  | initial release                           | 04/19/2012 |
| 1.01 | updated features                          | 06/04/2012 |
| 1.02 | V-Infinity branding removed               | 08/16/2012 |
| 1.03 | updated derating curves and spec          | 11/12/2013 |
| 1.04 | internal inductor & PCB structure changed | 10/26/2015 |

The revision history provided is for informational purposes only and is believed to be accurate.



**CUI INC**<sup>®</sup>

**Headquarters**  
20050 SW 112th Ave.  
Tualatin, OR 97062  
**800.275.4899**

Fax 503.612.2383  
**cui.com**  
techsupport@cui.com

CUI offers a two (2) year limited warranty. Complete warranty information is listed on our website.

CUI reserves the right to make changes to the product at any time without notice. Information provided by CUI is believed to be accurate and reliable. However, no responsibility is assumed by CUI for its use, nor for any infringements of patents or other rights of third parties which may result from its use.

CUI products are not authorized or warranted for use as critical components in equipment that requires an extremely high level of reliability. A critical component is any component of a life support device or system whose failure to perform can be reasonably expected to cause the failure of the life support device or system, or to affect its safety or effectiveness.