

Power cable - SAC-4P- 5,0-PUR/M12FRL - 1425079

Please be informed that the data shown in this PDF Document is generated from our Online Catalog. Please find the complete data in the user's documentation. Our General Terms of Use for Downloads are valid (<http://phoenixcontact.com/download>)



Power cable, 4-position, PUR halogen-free, black-gray RAL 7021, Socket angled M12, coding: L, on free cable end, cable length: 5 m, for direct current up to 16 A/63 V

Your advantages

- ✓ Easy and safe: 100% electrically tested plug-in components
- ✓ High-performance: DC connectors for up to 16 A and 63 V DC
- ✓ Protection against mismatching, thanks to special L-coding
- ✓ Our standard: robust halogen-free PUR cable



Key Commercial Data

Packing unit	1 pc
GTIN	 4 055626 384177
GTIN	4055626384177
Weight per Piece (excluding packing)	0.720 g
Custom tariff number	85444290
Country of origin	Poland

Technical data

Dimensions

Length of cable	5 m
-----------------	-----

Ambient conditions

Ambient temperature (operation)	-25 °C ... 85 °C (Plug / socket)
	-25 °C ... 85 °C (Plug / socket)
Degree of protection	IP65

Power cable - SAC-4P- 5,0-PUR/M12FRL - 1425079

Technical data

Ambient conditions

	IP67
--	------

General

Rated current at 40°C	16 A
Rated voltage	63 V DC
Number of positions	4
Color handle area	black
Insulation resistance	≥ 100 MΩ
Coding	L - Power
Standards/regulations	M12 connector IEC 61076-2-111
Status display	No
Protective circuit/component	unwired
Overvoltage category	III
Degree of pollution	3
Insertion/withdrawal cycles	≥ 100
Torque	0.4 Nm (M12 connector)

Material

Flammability rating according to UL 94	V0
Contact material	CuZn
Contact surface material	Ni/Au
Contact carrier material	PA
Material of grip body	PP
Material, knurls	Zinc die-cast, nickel-plated

Standards and Regulations

Standards/specifications	M12 connector IEC 61076-2-111
Flammability rating according to UL 94	V0

Cable

Cable type	PUR halogen-free black
Cable type (abbreviation)	PUR
UL AWM style	20233 / 10493 (80°C/300 V)
Conductor cross section	4x 2.5 mm ²
AWG power supply	14
Conductor structure, voltage supply	141x 0.15 mm
Core diameter including insulation	2.85 mm ±0.1 mm
Thickness, insulation	≥ 0.31 mm
Wire colors	brown, white, blue, black

Power cable - SAC-4P- 5,0-PUR/M12FRL - 1425079

Technical data

Cable

External sheath, color	black-gray RAL 7021
Outer sheath thickness	approx. 0.76 mm
External cable diameter D	8.8 mm ±0.25 mm
Minimum bending radius, fixed installation	5 x D
Minimum bending radius, flexible installation	10 x D
Number of bending cycles	4000000
Minimum bending radius, drag chain applications	10 x D
Traversing path	10 m
Traversing rate	3 m/s
Acceleration	10 m/s ²
Outer sheath, material	PUR
Material conductor insulation	PP
Conductor material	Bare Cu litz wires
Insulation resistance	≥ 1 GΩ*km (at 20 °C)
Conductor resistance	≤ 8 Ω/km (at 20 °C)
Nominal voltage, cable	≤ 300 V AC
Test voltage, cable	≥ 3000 V AC (Spark test)
Other resistance	Hydrolysis and microbe resistant as per VDE 0282 section 10
	Low adhesion
	abrasion-resistant
	Resistant to salt water
Ambient temperature (operation)	-50 °C ... 80 °C (cable, fixed installation)
	-30 °C ... 80 °C (cable, flexible installation)

Environmental Product Compliance

REACH SVHC	Lead 7439-92-1
China RoHS	Environmentally Friendly Use Period = 50 years
	For details about hazardous substances go to tab "Downloads", Category "Manufacturer's declaration"

Drawings

Power cable - SAC-4P- 5,0-PUR/M12FRL - 1425079

Schematic diagram

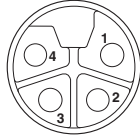

Pin assignment of M12 socket, 4-pos.

Cable cross section

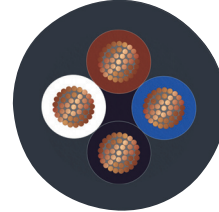

PUR halogen-free black [PUR]

Diagram

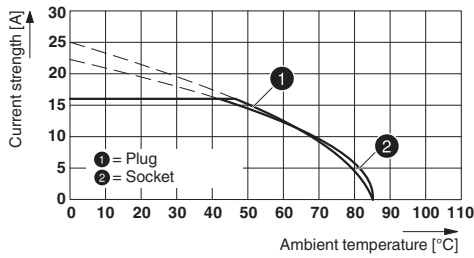

Dimensional drawing

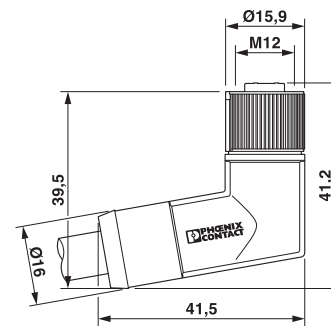

M12 x 1 socket, angled

Circuit diagram

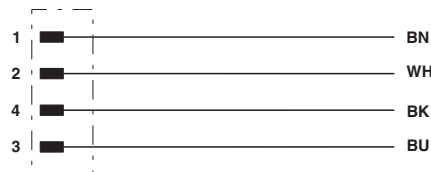

Contact assignment of the M12 socket

Classifications

eCl@ss

eCl@ss 10.0.1	27060311
eCl@ss 11.0	27060311
eCl@ss 5.1	27061801
eCl@ss 6.0	27279200
eCl@ss 7.0	27279218
eCl@ss 9.0	27060311

Power cable - SAC-4P- 5,0-PUR/M12FRL - 1425079

Classifications

ETIM

ETIM 3.0	EC002061
ETIM 4.0	EC001855
ETIM 5.0	EC001855
ETIM 6.0	EC001855
ETIM 7.0	EC001855

Approvals

Approvals

Approvals

UL Listed / cUL Listed / EAC-RoHS / EAC / cULus Listed

Ex Approvals

Approval details

UL Listed		http://database.ul.com/cgi-bin/XYV/template/LISEXT/1FRAME/index.htm	E468743
Nominal voltage UN		63 V	
Nominal current IN		16 A	
mm ² /AWG/kcmil		14	

cUL Listed		http://database.ul.com/cgi-bin/XYV/template/LISEXT/1FRAME/index.htm	E468743
Nominal voltage UN		63 V	
Nominal current IN		16 A	
mm ² /AWG/kcmil		14	

EAC-RoHS		RU D- DE.HB35.B.00387
----------	---	--------------------------

Power cable - SAC-4P- 5,0-PUR/M12FRL - 1425079

Approvals

EAC		RU C- DE.BL08.B.00286
-----	---	--------------------------

cULus Listed	
--------------	---

Accessories

Accessories

Screwdriver tools

Tool - SAC BIT M12-D16 - 1200305



Nut for assembling sensor/actuator cables with M12 connector and M12 connectors for assembly, knurl diameter: 16 mm, for 4 mm hexagonal drive

Screw plug - PROT M12 MS PWR - 1092802



An M12 screw plug for the unoccupied M12 females of the M12 POWER connectors, boxes, and flush-type connectors