

Description

The ZMOD4410 Evaluation Kit (EVK) is designed for evaluating Renesas' ZMOD4410 Gas Sensor Module for Indoor Air Quality. The total volatile organic compounds (TVOC) measurement is one of the indicators for indoor air quality (IAQ). In addition, measurement modes are provided to trigger an external device (e.g., fan, ventilation) based on the air quality change, and to discriminate sulfur odors.

Note: This document supports the waterproof and non-waterproof ZMOD4410 EVKs.

The *Gas Sensor Evaluation Software* allows Windows®-based operating systems to communicate with the ZMOD4410 EVK via a USB connection on the user's computer, which functions as a master. The software and additional related documentation is available on the Renesas website at www.IDT.com/ZMOD4410-EVK.

The EVK's Communication Board (HiCom) handles the interface between the user's computer and the ZMOD4410 module mounted on the ZMOD4410 Sensor Board (i.e., daughter board). Note: Only one Communication Board with one Sensor Board can be connected to the computer at a time.

The ZMOD4410 Evaluation Kit uses an FTDI controller on the Communication Board to handle the USB protocol, translate communications, and synchronize communications with the I2C interface. The Sensor Board includes a decoupling capacitor.

The Communication Board has devices mounted on both sides. The components on the top side generate a stable supply voltage. A potentiometer can be used to adjust the internal supply voltage in the typical range from 1.7V to 3.6V. Alternatively, the user's external supply voltage can be used. The intensity of the adjacent LED is proportional to the supply voltage.

Features

- User-friendly EVK expedites configuration and evaluation of the ZMOD4410 Gas Sensor Module
- Water and dustproof version available (IP67 certified)
- Supports different methods of operation, including Low Power and AI technology for improved ppm TVOC readings
- Operates with Renesas provided software; either with executable ZMOD4410 GUI or alternatively with firmware programming examples for Windows® and Linux®
- The modular design of the EVK allows simple connection of Sensor Boards for different gas sensor derivatives and easy integration with other sensor products via the I2C interface
- The required Gas Sensor Evaluation Software is available for free download on the Renesas website, which also provides background information on IAQ, TVOC, gas sensing, and how to use the sensor firmware.
- Additional pins to measure power consumption, supply voltage, and GPIO trigger for external device
- The bill of materials (BOM) and schematics for the ZMOD4410 Communication Board and Sensor Board are included in this document.

ZMOD4410-EVK Contents

- HiCom Communication Board
- Sensor Board with ZMOD4410 Gas Sensor Module
- 0.5m Type-B USB to Micro-USB Cable

ZMOD4410 Evaluation Kit

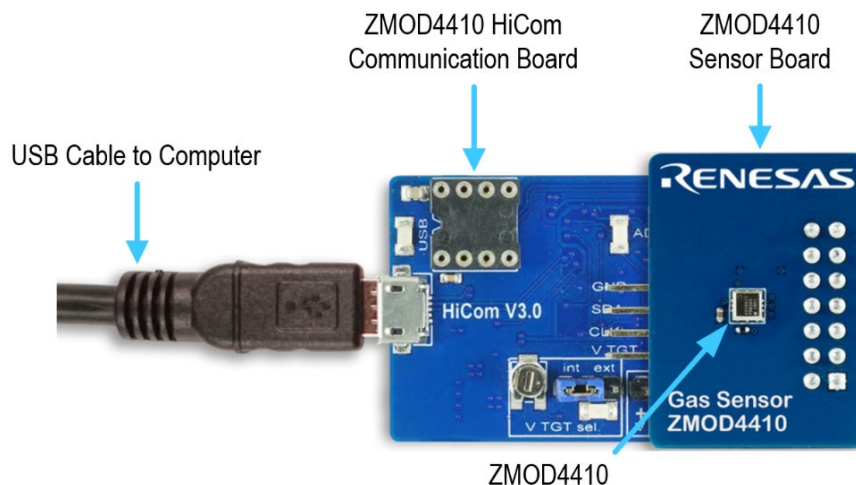



Important Equipment Warning: Ensure the correct connection of all cables. Supplying the board using the wrong polarity could result in damage to the board and/or the equipment. Check that all jumpers have been placed as specified in this document.

Contents

1. Setup	4
1.1 First Startup	4
1.2 Required or Recommended User Equipment.....	4
1.3 User Computer Requirements.....	4
1.3.1 Computer Requirements	4
1.4 Software Installation and Setup.....	4
1.5 EVK Hardware Connections and Initial Power-up	5
2. Usage Guide.....	8
2.1 Measurement Control Block	9
2.2 Signal Analysis Block and Options	9
2.3 Plot Visualization Block	11
2.4 Error Codes	11
3. Schematics.....	12
4. Bill of Materials (BOM).....	15
5. Board Layout	18
6. Ordering Information.....	20
7. Revision History.....	20

List of Figures

Figure 1. Initial Display after Starting the Sensor Evaluation Software.....	5
Figure 2. Jumper Settings and Connectors on Top Side of the ZMOD4410 Communication Board.....	6
Figure 3. Jumper Settings, Connections, and Test Points on the Communication Board for the Internal or External Supply Voltage.....	7
Figure 4. Initial Display for the ZMOD4410 Start-Up	8
Figure 5. Communication Board Schematic – Page 1	12
Figure 6. Communication Board Schematic – Page 2.....	13
Figure 7. Sensor Board Schematic.....	14
Figure 8. HiCom Communication Board Layout – Top Layer	18
Figure 9. HiCom Communication Board Layout – Bottom Layer.....	18
Figure 10. Sensor Board Layout – Top Layer with PIN Configuration on Connector X1	19
Figure 11. Sensor Board Layout – Bottom Layer	19

List of Tables

Table 1.	Evaluation Kit Connection Descriptions.....	6
Table 2.	Sample Rates.....	9
Table 3.	Analysis Tab User Options.....	9
Table 4.	Most Common Error Messages.....	11
Table 5.	Communication Board BOM.....	15
Table 6.	Sensor Board BOM.....	17
Table 7.	PIN Configuration on Connector X1.....	17

1. Setup

1.1 First Startup

To set up and operate the ZMOD4410 Evaluation Kit (EVK) with the ZMOD4410, refer to the *ZMOD4410 EVK Quick Start Guide* document included in the kit.

1.2 Required or Recommended User Equipment

By default, the internal supply voltage for powering the Sensor Board is generated from the USB voltage supplied by the user's computer via the USB cable. If there is a need for currents higher than the defined USB Standard (usually 500mA at 5V), an external voltage supply source can be used instead of the internally generated voltage supply provided on the Communication Board.

The external supply powers only the sensor modules, and not the communication board itself. The supply must meet the following requirements:

- Voltage – 1.7V to 3.6V
- Current must meet the user's specifications. The minimum is 30mA for electronics with additional need for each gas sensor module of approximately 13mA (in IAQ 1st Gen Continuous Operation Mode at 1.8V voltage supply).

1.3 User Computer Requirements

1.3.1 Computer Requirements

A Windows®-based computer is required for interfacing with the EVK and configuring the ZMOD4410. The user must have administrative rights on the computer to download and install the *Gas Sensor Evaluation Software*.

The computer must meet the following requirements:

- 1GB RAM
- Hard drive with at least 500MB free space
- 1 USB port (preferred USB 2.x)
- Windows Vista/Windows 7/Windows 8/Windows 10
- Internet access for initial download of the drivers and software

Important: Before installing and activating the software, assemble and connect the hardware for the kit to the user's computer according to steps 1 through 3 in section 1.5.

1.4 Software Installation and Setup

Before using the *Gas Sensor Evaluation Software*, the USB drivers for the FTDI device must be installed. Download the drivers and corresponding installation guides from the FTDI website at <https://www.ftdichip.com/Drivers/D2XX.htm>. The drivers will not affect the operation of any other USB peripherals. The kit does not need to be connected during installation of the drivers.

Complete the following procedure to download and install the *Gas Evaluation Software* with the kit connected:

1. Download the ZMOD4410 *Gas Sensor Evaluation Software* zip file at www.IDT.com/ZMOD4410-EVK.
2. Create a folder on the user's computer for the software (e.g., C:\Program Files (x86)\IDT Software). Extract the contents of the downloaded zip file into this folder.
3. Double-click on the extracted batch file *GasSensorEvaluation.bat* to start the software. There is no need for an installation of this software for user convenience. Figure 1 shows an example of the initial display after execution.

Select the measurement mode to run the sensor in "IAQ 1st Gen - Continuous Operation", or "IAQ 1st Gen - Low Power Operation", or "IAQ 2nd Gen" to either measure IAQ/TVOC/eCO₂. The best sensor module performance can be seen in the "IAQ 2nd Gen" operation mode. To trigger the activation of an external device by changes in the air quality choose the "Odor" option, or alternatively choose the "Sulfur Odor Discrimination" to make a differentiation to sulfur based odors.

Figure 1. Initial Display after Starting the Sensor Evaluation Software

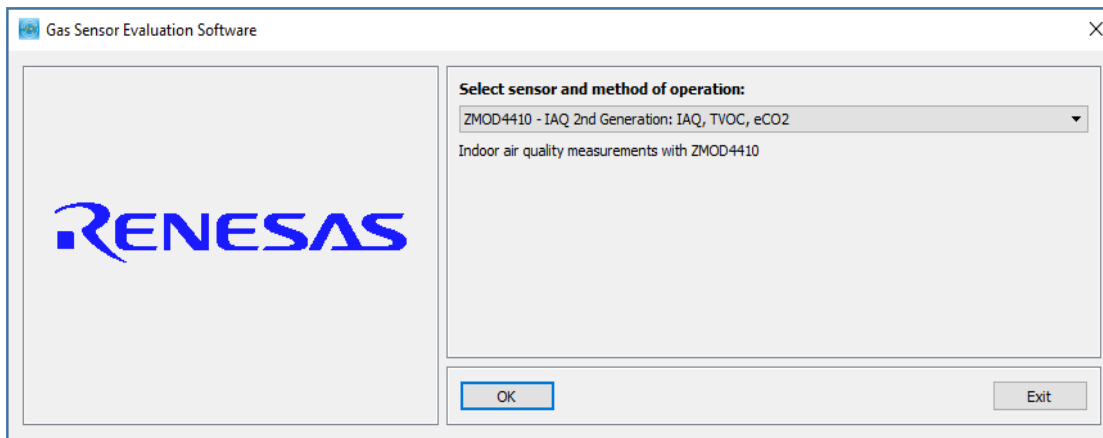

For IAQ measurements the “IAQ 2nd Gen” mode will give best results.

1.5 EVK Hardware Connections and Initial Power-up

To set up the EVK hardware before using the software, complete the following procedure:

1. Refer to Figure 2, Figure 3, and Table 1 to determine the correct jumper settings for the ZMOD4410 Communication Board depending on whether an external supply or the internal voltage supply on the board is used.
 - If the internal voltage supply is used, ensure that the jumper is across the pins labeled “int” on the K2 connector.
 - If using an external supply, ensure that the jumper is across the pins labeled “ext” on the K2 connector. In this case, without connecting the external supply to the Communication Board, verify that the external voltage supply setting does not exceed the voltage supply specifications -- a minimum of 1.7V or a maximum of 3.6V -- as per the *ZMOD4410 Datasheet*. With the external supply off, connect the external voltage to the 2-pin “+ - V ext” header adjacent to the K2 jumper with the orientation indicated in Figure 3. Note: If this option is used, adjustments of the external voltage are not possible on either the Communication Board, or the Sensor Board for adjusting an external voltage supply.
2. Install the ZMOD4410 Sensor Board on the 14-pin connector on the ZMOD4410 Communication Board taking care to ensure the proper orientation of the Sensor Board is as shown on page 1.
3. Insert the micro-USB cable into the X1 connector on the Communication Board and connect it to a free USB port on the user's computer. If the external voltage supply has been selected, turn on the external supply and verify that the D3 LED adjacent to the potentiometer is on. See Figure 2. Note: The intensity of the green D3 LED is proportional to the supply voltage.
4. Activate the software as described in section 1.4.
5. If the internal voltage is used, the *Gas Sensor Evaluation Software* activates the internal voltage after the sensor has been started. Use the metal potentiometer to the left of the K2 connector to adjust the VDD supply voltage in the typical range from 1.7V to 3.6V as measured across the V_TGT and GND pins available on the K3 connector as shown in Figure 3. Its initial adjustment on delivery provides a voltage of $V_{DD} \approx 2.0V$. Once a measurement has been started by the software, the green D3 LED adjacent to K2 will light with an intensity proportional to the voltage supply that was set using the potentiometer.
6. Verify that the red D1 LED is on, which indicates that the kit is properly connected and powered (see Figure 2).

The Communication Board provides the additional K3 and Modul1 connectors for the following optional uses as described in Table 1. To make use of any of these options, contact Renesas for further instructions (see contact information on last page).

- Extra measurement options (e.g., current consumption to determine the power requirements of the ZMOD4410)
- Connections for additional sensors (e.g., Renesas humidity sensor HS3001)

Figure 2. Jumper Settings and Connectors on Top Side of the ZMOD4410 Communication Board

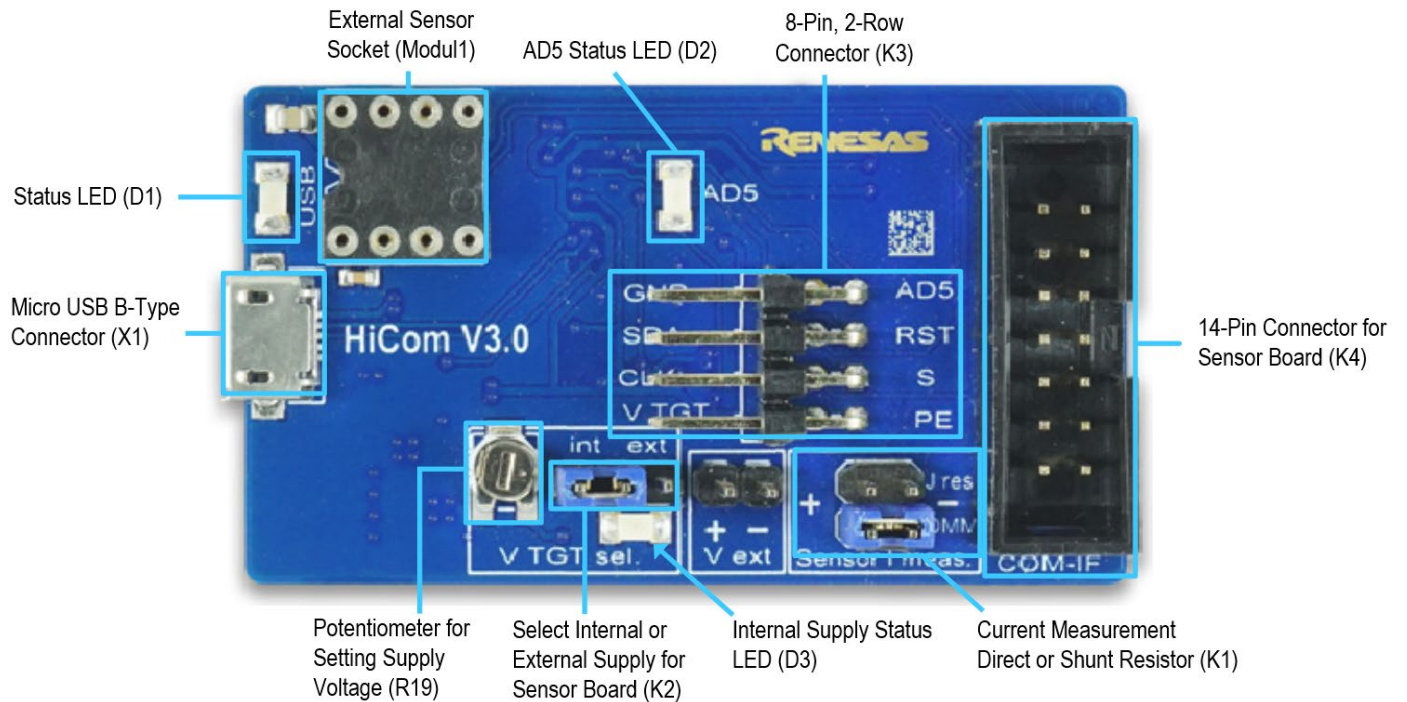
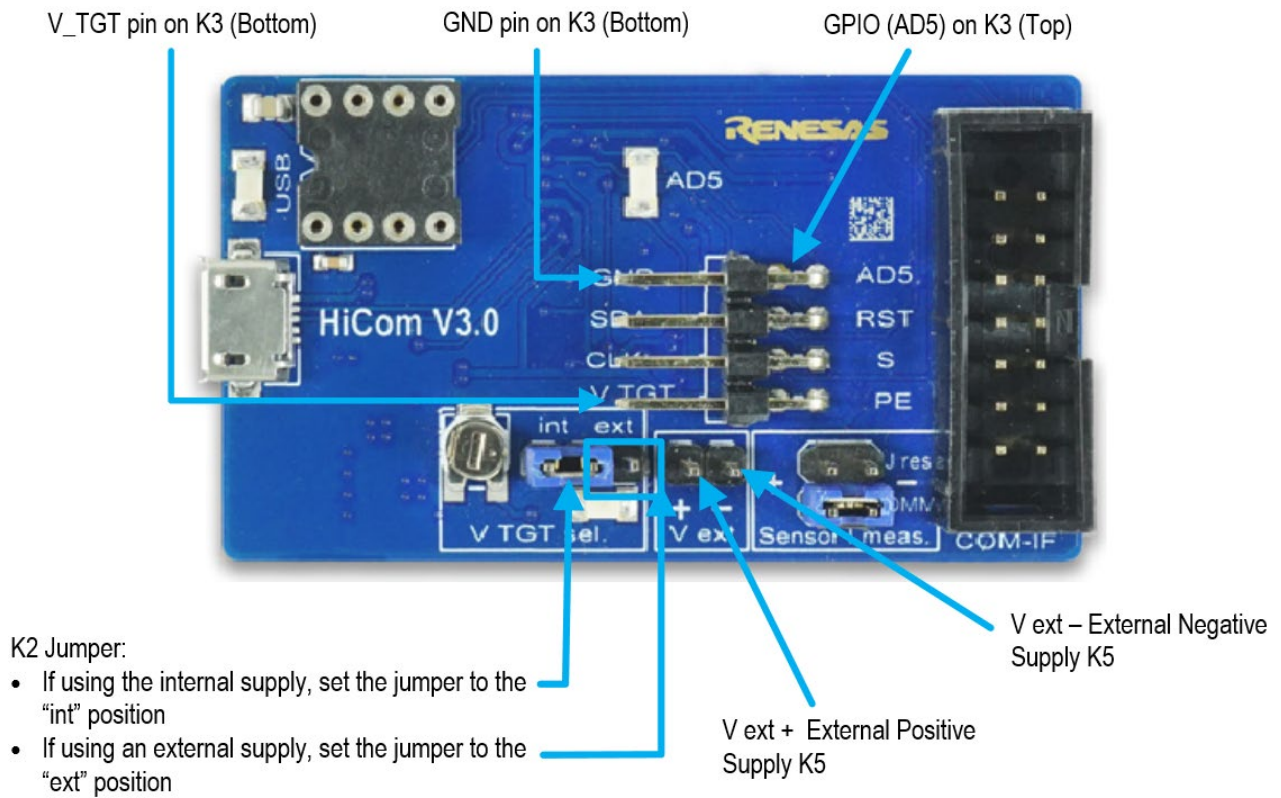

Table 1. Evaluation Kit Connection Descriptions

Connector	Type	Description
K1	4-pin, 2-row header	This jumper can be used to break the supply voltage line to measure the current consumption of a connected Sensor Board. Important: During normal operation, ensure that a jumper is on the "DMM" position as shown in Figure 2.
K2	3-pin header	This jumper selects either the internal or external voltage supply. For the proper position for the jumper, see Figure 3.
K3	8-pin, 2-row right-angle header	This connector can be used to connect the ZMOD4410 in different configurations or to measure the communication lines and voltages on the ZMOD4410 Sensor Board. AD5 is a GPIO pin that can be controlled via the software in the "Odor" measurement mode.
K4	14-pin connector	This is the connector for installing the ZMOD4410 Sensor Board on the Communication Board.
K5	2-pin header	This is the connector for an optional external voltage supply (see Figure 3).
D1	Status LED	This LED lights if the Communication Board is powered correctly (see Figure 2).
D2	Status LED	This LED lights if the software sets the trigger pin (see Figure 2).
D3	Status LED	This LED will light with an intensity proportional to the internal voltage supply that was set using the potentiometer (see Figure 2).
X1	Micro USB B-type	This is the micro-USB cable connector for connecting the Communication Board to the user's computer.
R19	Potentiometer	This potentiometer adjusts the internal supply voltage. The internal supply voltage can be adjusted by rotating the potentiometer with a small screwdriver.
Modul1	DIL socket	This socket can be used to add external components (e.g., a humidity sensor) to the Communication Board. For further instructions, contact Renesas.

Figure 3. Jumper Settings, Connections, and Test Points on the Communication Board for the Internal or External Supply Voltage



2. Usage Guide

When the *Gas Sensor Evaluation Software* is started, the initial window is displayed as shown in Figure 4. The initial display in all operation modes consists of three blocks:

- Measurement Control
- Signal Analysis
- Plot Visualization

Figure 4. Initial Display for the ZMOD4410 Start-Up

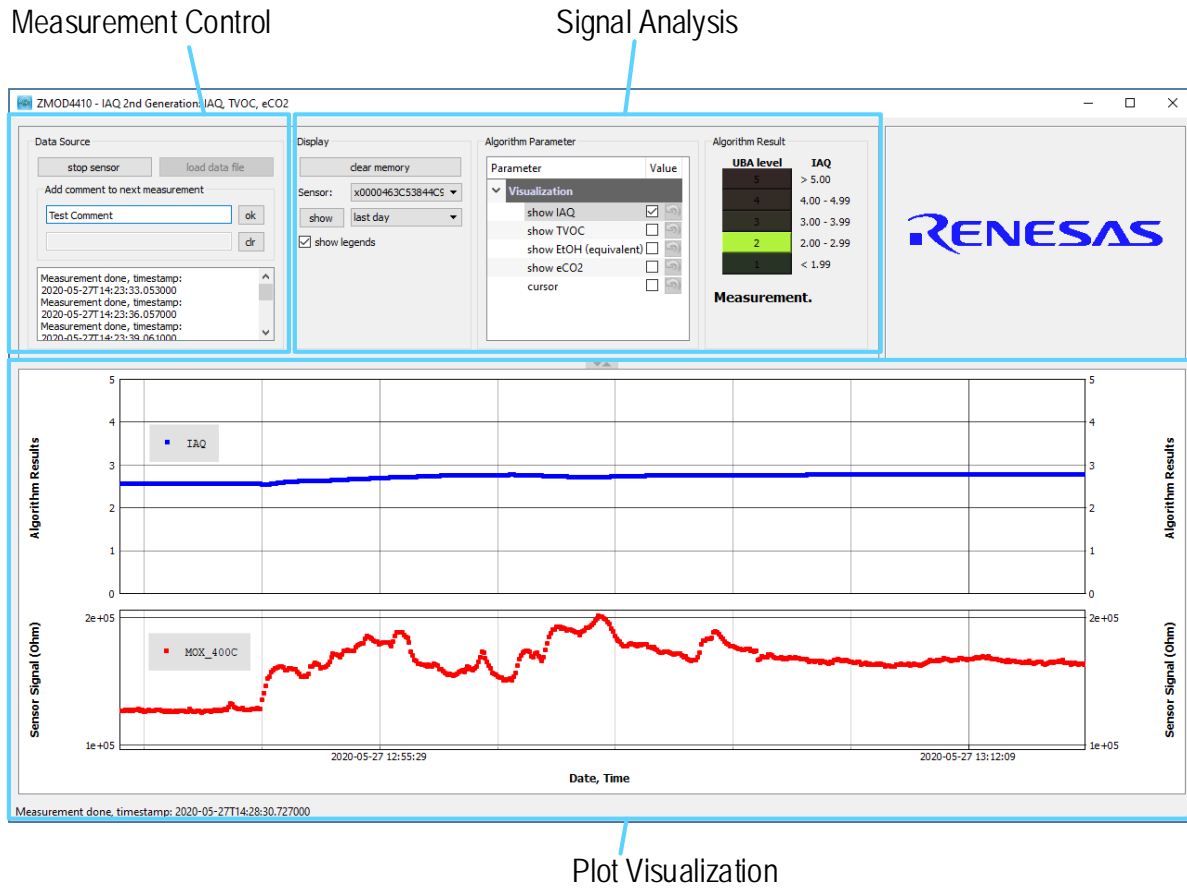

2.1 Measurement Control Block

The "Measurement" area of the display allows users to start the ZMOD4410's gas measurements. When the "start sensor" button is clicked, the button name changes to "stop sensor" and the measurement starts running continuously. The sampling rates are displayed in Table 2.

Table 2. Sample Rates

Operation Mode	Sample Rate [Seconds]
IAQ 2nd Gen	3.1
IAQ 1st Gen, Continuous	2
IAQ 1st Gen, Low Power	6
Odor	1 to 15
Sulfur Odor Discrimination	3.1

The results will be saved in a comma-separated file (CSV), which is user-selected via the file and path selection dialog when the sensor is started.

A comment (e.g., "Start test") can be added to the data entry by adding a text string to the "Add comment to next measurement" field and then clicking the "ok" button. If a measurement is already in progress, the comment will be added to the next measurement. The comments will be displayed in the plot and will be saved in the CSV result file. This facilitates tracking the user's experimental investigations. Below this entry field, a small window with a log field shows all events logged.

2.2 Signal Analysis Block and Options

Depending in the operation mode ("IAQ 1st Gen Continuous", "IAQ 1st Gen Low Power", "IAQ 2nd Gen", "Odor", or "Sulfur Odor Discrimination") the user will see slightly different options. While IAQ 1st Gen uses traditional computing algorithms, the IAQ 2nd Gen uses embedded AI technology for improved ppm TVOC. The available user options are described in Table 3 for all measurement modes.

Table 3. Analysis Tab User Options

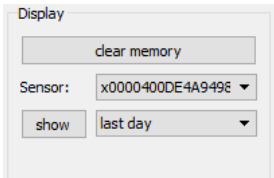
Display Section	Button/Action	Description
Data Source		This option allows the loading of previously recorded csv files into the EVK software when having the same csv file column structure. This feature can also be used to compare results of ZMOD4410 EVK software with ZMOD4410 firmware csv files. For this usage, it is not necessary to connect the ZMOD4410 Evaluation Kit hardware.
Display		<p>The "clear memory" button will delete all current data from the plots (memory). The data in the measurement file will remain.</p> <p>If measurements are acquired simultaneously for multiple ZMOD4410 gas sensors, the measurement results file can contain data from different sensors. In the "Sensor" drop-down menu, the user can choose a sensor to display by selecting the unique sensor identification number.</p> <p>The drop-down menu adjacent to the "show" button provides options for selecting the time period for showing the recent history or the complete data. Click the "show" button to apply new settings to the plots.</p>

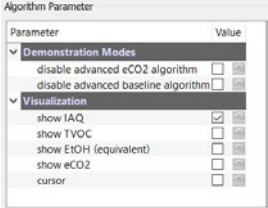
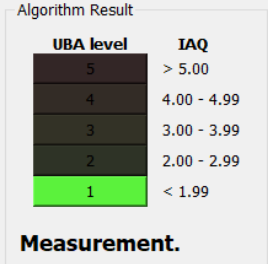
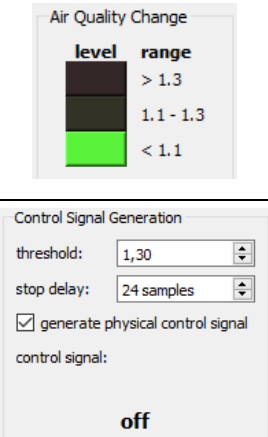
Display Section	Button/Action	Description									
<p>Algorithm Parameters for "IAQ 2nd Gen" and "IAQ 1st Gen"</p>		<p>This section allows choosing the parameters displayed in the Visualization Block. The options are:</p> <ul style="list-style-type: none"> IAQ rating according to UBA TVOC concentration (in mg/m3) Equivalent Ethanol (EtOH) concentration (in ppm) Estimation of Carbon Dioxide (eCO2) concentration (in ppm) Activate the cursor <p>Renesas' patented smart algorithm will provide eCO2 readings with high accuracy when activated (default). However, for demonstration reasons it might be useful to disable the eCO2 algorithm in the section "Demonstration Modes" to see very fast CO2 changes directly related to the VOC level. Another demo mode is available to deactivate the advanced baseline. This disabling will show faster TVOC results after startup but with a reduced sensitivity.</p> <p>For more information on IAQ, UBA, and eCO2, refer to the <i>ZMOD4410 White Paper – Overview of TVOC and Indoor Air Quality</i> and the <i>ZMOD4410 Application Note – Estimating Carbon Dioxide</i>.</p>									
<p>Algorithm Result</p>	<p>Stabilization 60% done.</p>	<p>The first 15 measurements of the algorithm will be taken for sensor stabilization. This field indicates how much time has been completed during this period. Raw sensor signals are shown on the "Sensor Signal (Ohms)" plot during this time, but the algorithm results are only calculated after stabilization. Note that this does not cover the full stabilization of the sensor module but rather covers only the first minutes during startup. If the sensor is in operation but does not report any algorithm output, check the available demo mode for Baseline Optimization in the "Algorithm Parameter" Section.</p>									
<p>Algorithm Parameters for "IAQ 2nd Gen" and "IAQ 1st Gen"</p>		<p>After the stabilization measurements, the "Algorithm Result" field shows a colored bar representing the results from the algorithm. The IAQ rating from the Federal German Environmental Agency (UBA) and the corresponding IAQ rating are shown.</p>									
<p>Algorithm Result "Odor Operation"</p>		<p>After the stabilization measurements, the "Algorithm Result" field shows a colored bar representing the results from the algorithm. The Air Quality Change is shown in three categories:</p> <table border="0"> <tr> <td>< 10%</td> <td>Minor changes or improvement in Air Quality:</td> <td>Control Signal Off</td> </tr> <tr> <td>10% to 30%</td> <td>Slight change in Air Quality:</td> <td>Control Signal Off</td> </tr> <tr> <td>> 30%</td> <td>Major change in Air Quality:</td> <td>Control Signal On</td> </tr> </table> <p>The threshold is set to 1.3 (default value). This means only a 30% Signal Change will lead to set the Control Signal to On status.</p> <p>After the Air Quality has improved, the control signal will remain On for 24 samples to avoid a hysteresis. This Control Signal triggers the AD5 GPIO pin on the HiCom board (connector K3) and its status is shown in the on/off field.</p>	< 10%	Minor changes or improvement in Air Quality:	Control Signal Off	10% to 30%	Slight change in Air Quality:	Control Signal Off	> 30%	Major change in Air Quality:	Control Signal On
< 10%	Minor changes or improvement in Air Quality:	Control Signal Off									
10% to 30%	Slight change in Air Quality:	Control Signal Off									
> 30%	Major change in Air Quality:	Control Signal On									

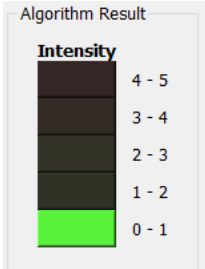
Display Section	Button/Action	Description
Algorithm Result "Sulfur Discrimination Operation"	 <p>The image shows a vertical bar chart titled 'Algorithm Result' with the word 'Intensity' above it. The chart has five horizontal segments of varying shades of gray, with the bottom segment being bright green. To the right of the segments are numerical ranges: 4 - 5, 3 - 4, 2 - 3, 1 - 2, and 0 - 1. The green segment corresponds to the 0 - 1 range.</p>	This method of operation uses a highly trained AI Neural Network to identify bad sulfur odors. The algorithm output is classified as "acceptable" and "bad" with an intensity indicator ranging from 1 (clean air) to 5 (very strong).

2.3 Plot Visualization Block

The lower half of the display provides a visualization of the data. This shows the plots for the options selected in the algorithm parameter field, as well as the raw sensor output signal (in Ω). For additional information, including application notes, white papers, and blogs, visit www.idt.com/ZMOD4410.

2.4 Error Codes

Due to some interference between the FTDI, Windows operation system, and the computer's USB driver, a startup problem may occur on some systems if the EVK is started on a USB 3 port. Renesas recommends using a USB 2.x port for the first initial startup of the EVK. Other common error messages are explained in Table 4.

Table 4. Most Common Error Messages

Error Code	Description and Solution
Cannot connect to hardware! Have you installed the FTDI D2XX driver? Is the hardware connected?	Please check if the FTDI driver is installed properly and the hardware is connected. Note that during the initial startup of the EVK software the HiCom must be connected to the computer.
Cannot write data file!	During the measurement, the csv data file could not be edited (e.g., file protection, missing drive)
Data not valid The data in file %s is not valid!	A csv file was loaded for analysis, which does not contain the necessary data.
Product not supported / Wrong Device	Please use a ZMOD4410 Sensor Board.
POR event detected during measurement validation	The ZMOD4410 sensor board was restarted during the measurement (e.g., problems with power supply, loose contacts, electromagnetic issue, ESD)
Wrong data file! Data file has not the right columns to store the measurements. Please create a new data file.	The EVK software tried to write measurement data to an existing csv file, which columns structure does not fit the recent software (EVK software version conflict).

3. Schematics

Figure 5. Communication Board Schematic - Page 1

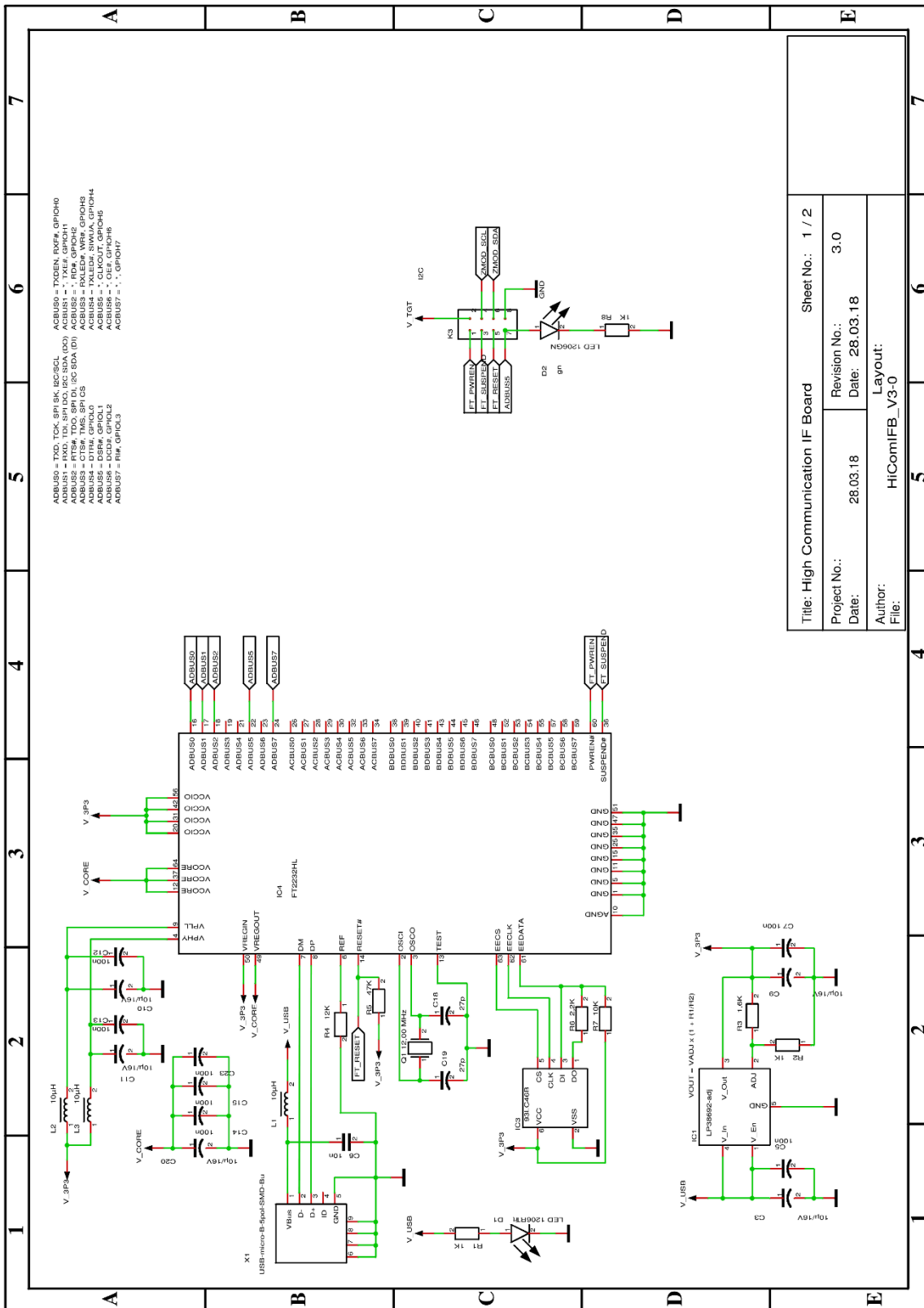
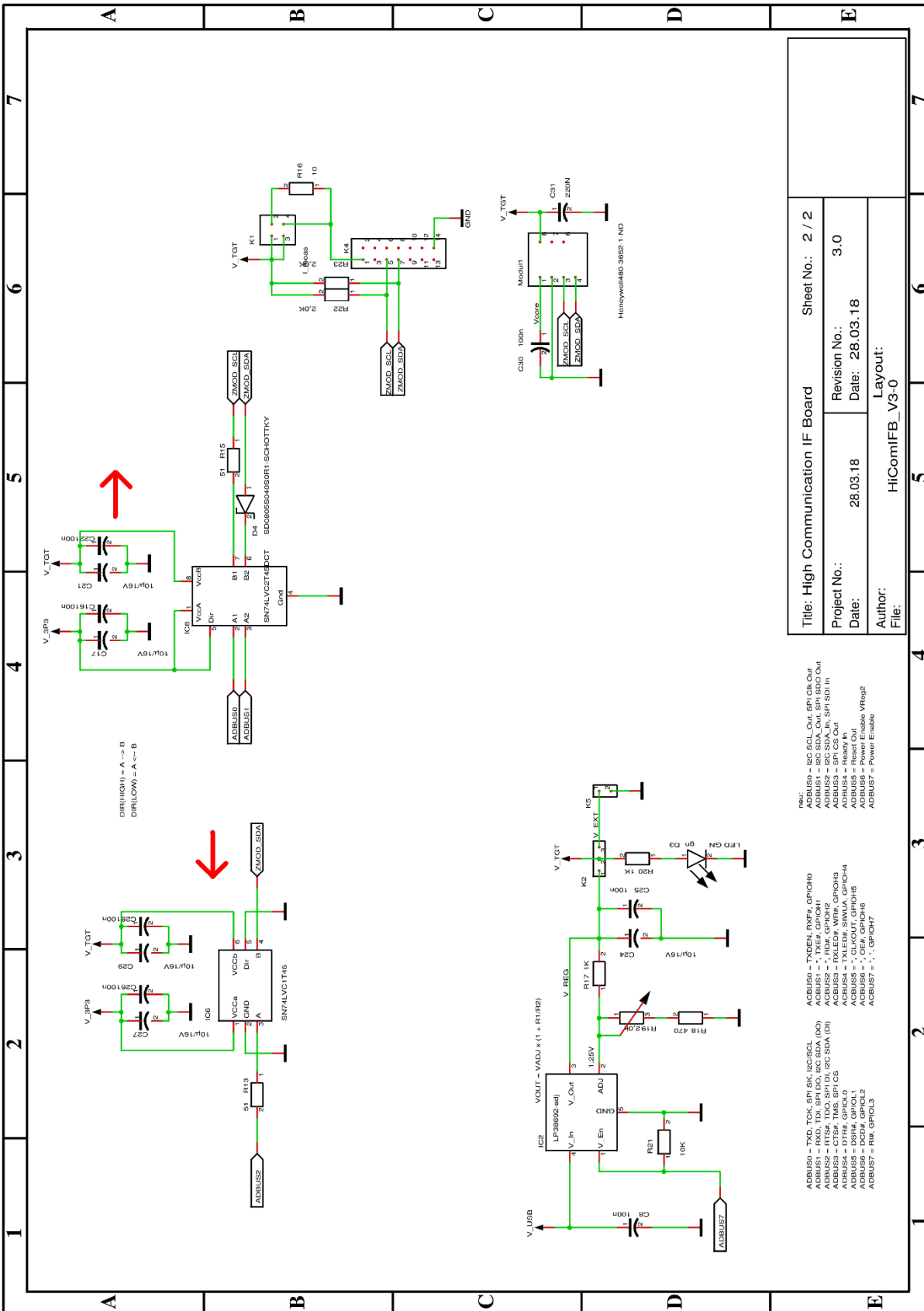

Figure 6. Communication Board Schematic - Page 2



Title: High Communication IF Board		Sheet No.: 2 / 2
Project No.:	28.03.18	Revision No.: 3.0
Date:	28.03.18	Date: 28.03.18
Author:	HiComIFB_V3-0	Layout:
File:		

new:
 ADDR50 = TXD, TXCK, SPI SK, I2C/SCL
 ADDR51 = TXD, TXEN, TX0, TX1, TX2, TX3, TX4, TX5, TX6, TX7, TX8, TX9, TXA, TXB, TXC, TXD, TXE, TXF, TXG, TXH, TXI, TXJ, TXK, TXL, TXM, TXN, TXO, TXP, TXQ, TXR, TXS, TXT, TXU, TXV, TXW, TXX, TXY, TXZ
 ADDR52 = TXD, TXEN, TX0, TX1, TX2, TX3, TX4, TX5, TX6, TX7, TX8, TX9, TXA, TXB, TXC, TXD, TXE, TXF, TXG, TXH, TXI, TXJ, TXK, TXL, TXM, TXN, TXO, TXP, TXQ, TXR, TXS, TXT, TXU, TXV, TXW, TXX, TXY, TXZ
 ADDR53 = TXD, TXEN, TX0, TX1, TX2, TX3, TX4, TX5, TX6, TX7, TX8, TX9, TXA, TXB, TXC, TXD, TXE, TXF, TXG, TXH, TXI, TXJ, TXK, TXL, TXM, TXN, TXO, TXP, TXQ, TXR, TXS, TXT, TXU, TXV, TXW, TXX, TXY, TXZ
 ADDR54 = TXD, TXEN, TX0, TX1, TX2, TX3, TX4, TX5, TX6, TX7, TX8, TX9, TXA, TXB, TXC, TXD, TXE, TXF, TXG, TXH, TXI, TXJ, TXK, TXL, TXM, TXN, TXO, TXP, TXQ, TXR, TXS, TXT, TXU, TXV, TXW, TXX, TXY, TXZ
 ADDR55 = TXD, TXEN, TX0, TX1, TX2, TX3, TX4, TX5, TX6, TX7, TX8, TX9, TXA, TXB, TXC, TXD, TXE, TXF, TXG, TXH, TXI, TXJ, TXK, TXL, TXM, TXN, TXO, TXP, TXQ, TXR, TXS, TXT, TXU, TXV, TXW, TXX, TXY, TXZ
 ADDR56 = TXD, TXEN, TX0, TX1, TX2, TX3, TX4, TX5, TX6, TX7, TX8, TX9, TXA, TXB, TXC, TXD, TXE, TXF, TXG, TXH, TXI, TXJ, TXK, TXL, TXM, TXN, TXO, TXP, TXQ, TXR, TXS, TXT, TXU, TXV, TXW, TXX, TXY, TXZ
 ADDR57 = TXD, TXEN, TX0, TX1, TX2, TX3, TX4, TX5, TX6, TX7, TX8, TX9, TXA, TXB, TXC, TXD, TXE, TXF, TXG, TXH, TXI, TXJ, TXK, TXL, TXM, TXN, TXO, TXP, TXQ, TXR, TXS, TXT, TXU, TXV, TXW, TXX, TXY, TXZ

ADDR50 = TXD, TXCK, SPI SK, I2C/SCL
 ADDR51 = TXD, TXEN, TX0, TX1, TX2, TX3, TX4, TX5, TX6, TX7, TX8, TX9, TXA, TXB, TXC, TXD, TXE, TXF, TXG, TXH, TXI, TXJ, TXK, TXL, TXM, TXN, TXO, TXP, TXQ, TXR, TXS, TXT, TXU, TXV, TXW, TXX, TXY, TXZ
 ADDR52 = TXD, TXEN, TX0, TX1, TX2, TX3, TX4, TX5, TX6, TX7, TX8, TX9, TXA, TXB, TXC, TXD, TXE, TXF, TXG, TXH, TXI, TXJ, TXK, TXL, TXM, TXN, TXO, TXP, TXQ, TXR, TXS, TXT, TXU, TXV, TXW, TXX, TXY, TXZ
 ADDR53 = TXD, TXEN, TX0, TX1, TX2, TX3, TX4, TX5, TX6, TX7, TX8, TX9, TXA, TXB, TXC, TXD, TXE, TXF, TXG, TXH, TXI, TXJ, TXK, TXL, TXM, TXN, TXO, TXP, TXQ, TXR, TXS, TXT, TXU, TXV, TXW, TXX, TXY, TXZ
 ADDR54 = TXD, TXEN, TX0, TX1, TX2, TX3, TX4, TX5, TX6, TX7, TX8, TX9, TXA, TXB, TXC, TXD, TXE, TXF, TXG, TXH, TXI, TXJ, TXK, TXL, TXM, TXN, TXO, TXP, TXQ, TXR, TXS, TXT, TXU, TXV, TXW, TXX, TXY, TXZ
 ADDR55 = TXD, TXEN, TX0, TX1, TX2, TX3, TX4, TX5, TX6, TX7, TX8, TX9, TXA, TXB, TXC, TXD, TXE, TXF, TXG, TXH, TXI, TXJ, TXK, TXL, TXM, TXN, TXO, TXP, TXQ, TXR, TXS, TXT, TXU, TXV, TXW, TXX, TXY, TXZ
 ADDR56 = TXD, TXEN, TX0, TX1, TX2, TX3, TX4, TX5, TX6, TX7, TX8, TX9, TXA, TXB, TXC, TXD, TXE, TXF, TXG, TXH, TXI, TXJ, TXK, TXL, TXM, TXN, TXO, TXP, TXQ, TXR, TXS, TXT, TXU, TXV, TXW, TXX, TXY, TXZ
 ADDR57 = TXD, TXEN, TX0, TX1, TX2, TX3, TX4, TX5, TX6, TX7, TX8, TX9, TXA, TXB, TXC, TXD, TXE, TXF, TXG, TXH, TXI, TXJ, TXK, TXL, TXM, TXN, TXO, TXP, TXQ, TXR, TXS, TXT, TXU, TXV, TXW, TXX, TXY, TXZ

Figure 7. Sensor Board Schematic

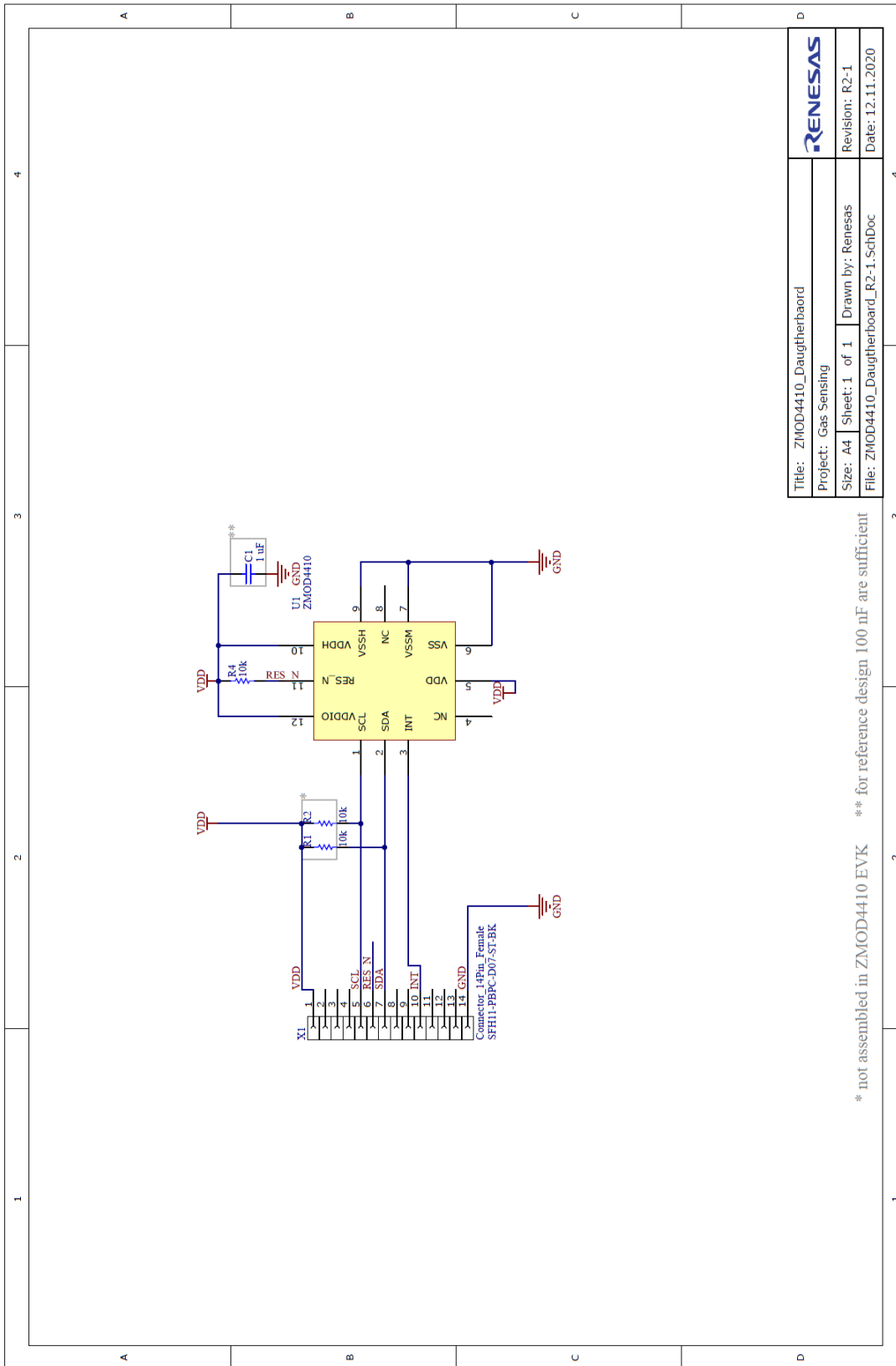

4. Bill of Materials (BOM)

Table 5. Communication Board BOM

Pos	Name	Value	Package
1	C3	10 μ F/16V	0805
2	C5	100nF	0603
3	C6	10nF	0805
4	C7	100nF	0603
5	C8	100nF	0603
6	C9	10 μ F/16V	0805
7	C10	10 μ F/16V	0805
8	C11	10 μ F/16V	0805
9	C12	100nF	0603
10	C13	100nF	0603
11	C14	100nF	0603
12	C15	100nF	0603
13	C16	100nF	0603
14	C17	10 μ F/16V	0805
15	C18	27pF	0603
16	C19	27pF	0603
17	C20	10 μ F/16V	0805
18	C21	10 μ F/16V	0805
19	C22	100nF	0603
20	C23	100nF	0603
21	C24	10 μ F/16V	0805
22	C25	100nF	0603
23	C26	100nF	0603
24	C27	10 μ F/16V	0805
25	C28	100nF	0603
26	C29	10 μ F/16V	0805
27	C30	100nF	0603
28	C31	220nF	0805
29	D1	LED 1206RT	1206-DIODE
30	D2	LED 1206GN	1206-DIODE
31	D3	LED 1206GN	1206-DIODE
32	D4	SD0805S040S0R1-SCHOTTKY	0805-DIODE
33	IC1	LP38692-adj	SOT-223-5

Pos	Name	Value	Package
34	IC2	LP38692-adj	SOT-223-5
35	IC3	93LC46B	SOT23-6
36	IC4	FT2232HL	LQFP64
37	IC6	SN74LVC1T45	SOT23-6
38	IC8	SN74LVC2T45DCT	SSOP8_0,65
39	K1	I_meas	2X02
40	K2	Select	1X03
41	K3	K2X4	2X04-90
42	K4	K2X7	LH-14
43	K5	V_EXT	1X02
44	L1	10μH	1210
45	L2	10μH	1210
46	L3	10μH	1210
47	Modul1	Honeywell480-3652-1-ND	DIL8 SMD SOCKET
48	Q1	12.00MHz	QUARZ-ABM3
49	R1	1kΩ	0805
50	R2	1kΩ	0805
51	R3	1.6kΩ	0805
52	R4	12kΩ	0805
53	R5	47kΩ	0805
54	R6	2.2kΩ	0805
55	R7	10kΩ	0805
56	R8	1kΩ	0805
57	R13	51Ω	0805
58	R15	51Ω	0805
59	R16	10Ω	0805
60	R17	1kΩ	0805
61	R18	470Ω	0805
62	R19	2.0kΩ	TRIMMER-3142SERIES
63	R20	1kΩ	0805
64	R21	10kΩ	0805
65	R22	2.0kΩ	0805
66	R23	2.0kΩ	0805
67	X1	USB-micro-B-5pol-SMD-Bu	USB-MICRO_TYPB_AMTEK

Table 6. Sensor Board BOM

Designator	Quantity	Manufacturer	Manufacturer Part Number
C1	1	Murata	GRM155R70J105KA12D
R4	1	Yageo	RC0402JR-0710KL
U1	1	Renesas	ZMOD4410
X1	1	Sullins	SFH11-PBPC-D07-ST-BK

Table 7. PIN Configuration on Connector X1

Pin Number	Pin Description
1	VDD
2	n.c.
3	n.c.
4	n.c.
5	SCL
6	RES_N
7	SDA
8	n.c.
9	n.c.
10	INT
11	n.c.
12	n.c.
13	n.c.
14	GND

5. Board Layout

Figure 8. HiCom Communication Board Layout - Top Layer

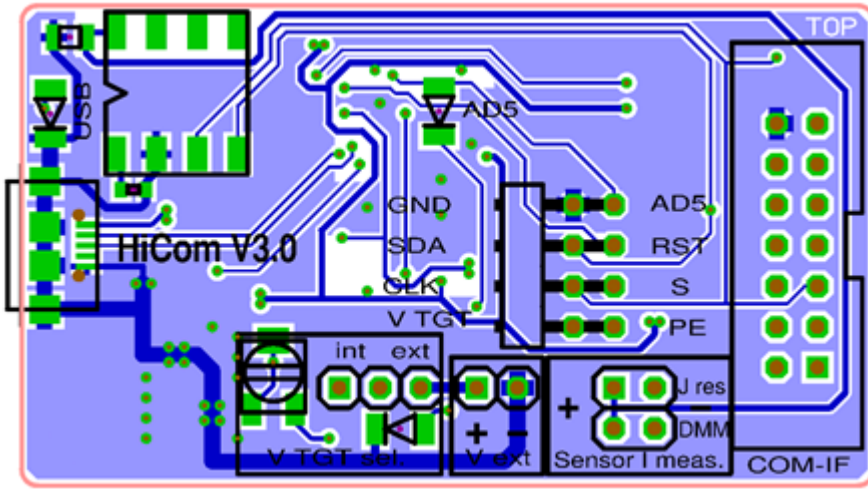

Figure 9. HiCom Communication Board Layout - Bottom Layer

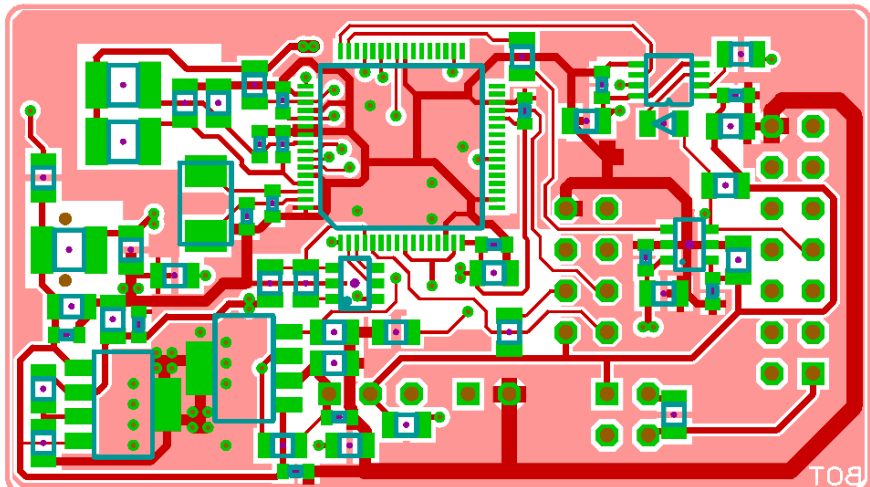
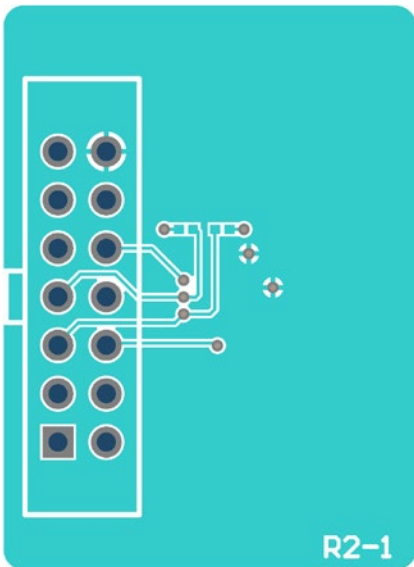

Figure 10. Sensor Board Layout – Top Layer with PIN Configuration on Connector X1



Figure 11. Sensor Board Layout – Bottom Layer



6. Ordering Information

Orderable Part Number	Description
ZMOD4410-EVK-HC	ZMOD4410 Evaluation Kit including the ZMOD4410 Sensor Board, HiCom Communication Board (USB Interface), and Micro-USB Cable. The <i>Gas Evaluation Software</i> is available for download free of charge on www.IDT.com/ZMOD4410-EVK .)
ZMOD4410-EVK-HC-WP	ZMOD4410 Evaluation Kit including the water- and dust proof ZMOD4410 Sensor Board, HiCom Communication Board (USB Interface), and Micro-USB Cable. The <i>Gas Evaluation Software</i> is available for download free of charge on www.IDT.com/ZMOD4410-EVK .)

7. Revision History

Revision Date	Description of Change
November 13, 2020	<ul style="list-style-type: none"> • Updated to support the Waterproof version of the EVK
June 3, 2020	<ul style="list-style-type: none"> • Added IAQ 2nd Gen method of operation • Added Sulfur odor Discrimination method of operation • Updated the Gas Sensor Evaluation software version • Updated the link to the FTDI driver • Updated the stabilization time • Added Error Codes
November 1, 2018	Updated with Low Power operation mode.
September 25, 2018	Updated with Odor operation mode.
May 19, 2018	Initial release.

IMPORTANT NOTICE AND DISCLAIMER

RENESAS ELECTRONICS CORPORATION AND ITS SUBSIDIARIES (“RENESAS”) PROVIDES TECHNICAL SPECIFICATIONS AND RELIABILITY DATA (INCLUDING DATASHEETS), DESIGN RESOURCES (INCLUDING REFERENCE DESIGNS), APPLICATION OR OTHER DESIGN ADVICE, WEB TOOLS, SAFETY INFORMATION, AND OTHER RESOURCES “AS IS” AND WITH ALL FAULTS, AND DISCLAIMS ALL WARRANTIES, EXPRESS OR IMPLIED, INCLUDING, WITHOUT LIMITATION, ANY IMPLIED WARRANTIES OF MERCHANTABILITY, FITNESS FOR A PARTICULAR PURPOSE, OR NON-INFRINGEMENT OF THIRD PARTY INTELLECTUAL PROPERTY RIGHTS.

These resources are intended for developers skilled in the art designing with Renesas products. You are solely responsible for (1) selecting the appropriate products for your application, (2) designing, validating, and testing your application, and (3) ensuring your application meets applicable standards, and any other safety, security, or other requirements. These resources are subject to change without notice. Renesas grants you permission to use these resources only for development of an application that uses Renesas products. Other reproduction or use of these resources is strictly prohibited. No license is granted to any other Renesas intellectual property or to any third party intellectual property. Renesas disclaims responsibility for, and you will fully indemnify Renesas and its representatives against, any claims, damages, costs, losses, or liabilities arising out of your use of these resources. Renesas' products are provided only subject to Renesas' Terms and Conditions of Sale or other applicable terms agreed to in writing. No use of any Renesas resources expands or otherwise alters any applicable warranties or warranty disclaimers for these products.

(Rev.1.0 Mar 2020)

Corporate Headquarters

TOYOSU FORESIA, 3-2-24 Toyosu,
Koto-ku, Tokyo 135-0061, Japan
www.renesas.com

Contact Information

For further information on a product, technology, the most up-to-date version of a document, or your nearest sales office, please visit:
www.renesas.com/contact/

Trademarks

Renesas and the Renesas logo are trademarks of Renesas Electronics Corporation. All trademarks and registered trademarks are the property of their respective owners.