

MAX32010

25V Span, 1.2A Device Power Supply (DPS)

General Description

The MAX32010 provides all the key features of a device power supply (DPS) common to automatic test equipment (ATE) and other instrumentation. Its small size, high level of integration, and superb flexibility make the MAX32010 ideal and economical for multisite systems requiring many device power supplies.

The MAX32010 has multiple input control voltages that allow independent setting of the output voltage and voltage/current limits. The MAX32010 is a voltage source when the load current is between the two programmed limits, and it transitions gracefully into a precision current source/sink if a programmed current limit is reached. The output features two independently adjustable voltage clamps that limit both the negative and positive output voltage.

The MAX32010 can source voltages spanning 25V and can source currents as high as $\pm 1200\text{mA}$. The DPS can support an external buffer for sourcing and sinking higher currents. Multiple MAX32010s can be configured in parallel to load-share, allowing higher output currents with greater flexibility. The MAX32010 features operation over a wide range of load conditions. Programmability allows optimizing of settling time, over-/undershoot, and stability. Configurable range-change glitch control circuit minimizes output transients during range transitions.

The MAX32010 offers load regulation of 1mV at 1200mA load and is available in a 100-pin TQFP package with an exposed pad on the top for heat removal.

Applications

- Memory Testers
- VLSI Testers
- System-on-a-Chip Testers
- Industrial Systems
- Programmable Power Supplies

Benefits and Features

- Programmability for Multiple ATE Applications
 - Programmable Current and Voltage Compliance
 - Programmable Current Ranges
 - $\pm 200\mu\text{A}$
 - $\pm 2\text{mA}$
 - $\pm 20\text{mA}$
 - $\pm 1200\text{mA}$
 - External Buffer Supports Higher Currents with up to 16 Parallel Devices
 - Programmable Gain Allows a Wide Range of DACs
- High Accuracy and Flexible Control for Optimal Performance
 - Load Regulation of 1mV at 1200mA
 - Programmable Compensation for Wide Range of Loads
 - Range Change Glitch Control
 - Integrated Window Comparator for Go/No-Go Testing
 - External Test Mode Enables I_{DDQ} Measurement with Reprogramming
 - 3-Wire, 20MHz SPI Interface
- Integrated Protection for Robustness
 - Thermal Warning Flag and Thermal Shutdown
 - Short-Circuit Protection
- Compact 14mm x 14mm, 100-Pin TQFP Package

Ordering Information appears at end of data sheet.

Absolute Maximum Ratings

V _{CC} to V _{EE}	+31V	Continuous Power Dissipation ((T _A = +70°C) 100-Pin TQFP-EPR-IDP (derated at 166.7mW/°C above +70°C)).....	13.33W
V _{CC} to AGND	+20V	Junction Temperature.....	+150°C
V _{EE} to AGND	-15V	Storage Temperature.....	-65°C to +150°C
V _L to DGND.....	+6V	Lead Temperature (soldering, 10s)	+300°C
AGND to DGND	-0.5V to +0.5V	Soldering Temperature ((reflow) lead(Pb)-free packages)	+260°C
Digital Inputs	-0.3V to (V _L + 0.3)V		
All Other Pins	(V _{EE} - 0.3)V to (V _{CC} + 0.3)V		

Stresses beyond those listed under "Absolute Maximum Ratings" may cause permanent damage to the device. These are stress ratings only, and functional operation of the device at these or any other conditions beyond those indicated in the operational sections of the specifications is not implied. Exposure to absolute maximum rating conditions for extended periods may affect device reliability.

Package Information

Package Code	C100E+8R
Outline Number	21-0148
Land Pattern Number	90-0159
Thermal Resistance, Four-Layer Board:	
Junction to Ambient (θ _{JA})	32°C/W
Junction to Case (θ _{JC})	0.4°C/W

For the latest package outline information and land patterns (footprints), go to www.maximintegrated.com/packages. Note that a "+", "#", or "-" in the package code indicates RoHS status only. Package drawings may show a different suffix character, but the drawing pertains to the package regardless of RoHS status.

Package thermal resistances were obtained using the method described in JEDEC specification JESD51-7, using a four-layer board. For detailed information on package thermal considerations, refer to www.maximintegrated.com/thermal-tutorial.

Electrical Characteristics

(V_{CC} = +12V, V_{EE} = -12V, V_L = +3.3V, C_{C1} = 350pF, C_L = C_{MEAS} = C_{IMEAS} = 100pF, T_J = +30°C to +100°C; Typical values are at T_J = +30°C, unless otherwise specified.) (Note 1, Note 2)

PARAMETER	SYMBOL	CONDITIONS	MIN	TYP	MAX	UNITS
VOLTAGE OUTPUT						
Output Voltage Range	V _{DUT}	DUT current below 10% of FSR current	V _{EE} + 2.5		V _{CC} - 2.5	V
		DUT current = +1200mA, range A (Note 2)	0		+7	
		DUT current = -1200mA, range A (Note 2)	-7		0	
		DUT current at full scale (I _{DUT} = 200µA, 2mA, 20mA, or 200mA)	V _{EE} + 5		V _{CC} - 5	
Output Offset	V _{OS}	V _{IN} = 0V, I _{OUT} = 0A (no load), gain = +1			±25	mV
Output Voltage Temperature Coefficient	V _{OSTC}			±50		µV/°C
Voltage Gain Error	V _{GE}	Gain = +1			±1.25	%

($V_{CC} = +12V$, $V_{EE} = -12V$, $V_L = +3.3V$, $C_{C1} = 350pF$, $C_L = C_{MEAS} = C_{IMEAS} = 100pF$, $T_J = +30^{\circ}C$ to $+100^{\circ}C$; Typical values are at $T_J = +30^{\circ}C$, unless otherwise specified.) (Note 1, Note 2)

PARAMETER	SYMBOL	CONDITIONS		MIN	TYP	MAX	UNITS
		Gain = +2				±1.25	
		Gain = +6				±2.25	
		Gain = -1				±1.25	
		Gain = -2				±1.25	
		Gain = -6				±2.25	
Voltage Gain Temperature Coefficient	V_{GETC}				±5		ppm/°C
Linearity Error	V_{LER}	(Note 3, Note 4, Note 5)	Gain and offset errors calibrated out; $I_{OUT} = 0$ for ranges A, C, and D; ±20mA for range B; gain = +1			±0.02	%FSR
Off-State Leakage Current	$HIZF_{LK}$	$R_{COMF} = (V_{CC} - 2.5V)$ to $(V_{EE} + 2.5V)$		-30		+30	nA
DUT GROUND SENSE							
Voltage Range	ΔV_{DUTGND}	$V_{DUTGSNS}$ to V_{AGND}		±500	±700		mV
LOAD REGULATION (Note 6)							
Voltage	ΔV_{DUT}	Range A, gain = +1, $V_{IN} = (V_{CC} - 5V)$ to $(V_{EE} + 5V)$, ±1200mA current load step (Note 5)			±1	±7	mV
CURRENT OUTPUT							
Output Current Range	I_{DUT}	Range D, $R_D = 5000\Omega$				±200	μA
		Range C, $R_C = 500\Omega$				±2	mA
		Range B, $R_B = 50\Omega$				±20	
		Range A, $R_A = 0.83\Omega$				±1200	
Input Voltage Range Corresponding to the Full-Scale Force Current	V_{INI}	$I_{OSI} = AGND$		-4		+4	V
		$V_{IOSI} = V_{AGND} + 4V$		0		+8	
Current-Sense Amp Offset Voltage Input	V_{IOSI}	Relative to AGND		-0.2		+4.4	V
Output Current Offset	I_{OS}	$V_{RCOMF} = 0V$ (Note 4)			±0.1	±0.5	%FSR
Force-Current Offset Temperature Coefficient	I_{OSTC}				±20		ppm/°C
Gain Error	I_{GE}	$V_{RCOMF} = 0V$, $I_{OUT} = \pm FSR$				±1.0	%
Forced-Current Gain Temperature Coefficient	I_{GETC}				±20		ppm/°C
Output Over Current-Limit Range (Note 4)	I_{OCL}	Range D, $I_{OUT} = \pm 200\mu A$		±130	±147	±162	%FSR
		Range C, $I_{OUT} = \pm 2mA$		±130	±147	±162	
		Range B, $I_{OUT} = \pm 20mA$		±130	±147	±162	
		Range A, $I_{OUT} = \pm 1200mA$		±107	±120	±138	

($V_{CC} = +12V$, $V_{EE} = -12V$, $V_L = +3.3V$, $C_{C1} = 350pF$, $C_L = C_{MEAS} = C_{IMEAS} = 100pF$, $T_J = +30^{\circ}C$ to $+100^{\circ}C$; Typical values are at $T_J = +30^{\circ}C$, unless otherwise specified.) (Note 1, Note 2)

PARAMETER	SYMBOL	CONDITIONS		MIN	TYP	MAX	UNITS
Linearity Error	I_{LER}	Gain, offset, and CMR errors calibrated out; $V_{IOSI} = -0.2V$ and $+4.4V$; ranges B, C, and D (Note 4, Note 5, Note 7)				± 0.02	%FSR
Rejection of Output Error Due to Common-Mode Load Voltage	CMR_{OER}	Range D, $I_{OUT} = 0$, $V_{RCOMF} = (V_{EE} + 2.5V)$ and $(V_{CC} - 2.5V)$, measured across R_D			0.001	0.005	%FSR/V
CURRENT MONITOR							
Measured Current Range	I_{DUTM}	Range D			± 200		μA
		Range C			± 2		mA
		Range B			± 20		
		Range A			± 1200		
Current-Sense-Amp Voltage Range	V_{ISENSE}	$IOSI = AGND$		-4		+4	V
		$V_{IOSI} = V_{AGND} + 4V$		0		+8	
Current-Sense-Amp Offset Voltage Input	V_{IOSI}	Relative to AGND		-0.2		+4.4	V
Current-Sense-Amp Offset	I_{MOS}	(Note 4)	$V_{RCOMF} = 0V$		± 0.1	± 0.5	%FSR
Measured-Current Offset Temperature Coefficient	I_{MOSTC}				± 20		ppm/ $^{\circ}C$
Gain Error	I_{MGE}	$V_{RCOMF} = 0V$, $I_{OUT} = \pm FSR$				± 1	%
Measured-Current Gain Temperature Coefficient	I_{MGTC}				± 20		ppm/ $^{\circ}C$
Linearity Error	I_{MLE}	(Note 4, Note 5)	Gain, offset, and CMR errors calibrated out; $V_{IOSI} = -0.2V$ and $+4.4V$, range B			± 0.02	%FSR
Rejection of Output Error Due to Common-Mode Load Voltage	CMR_{MOE}	Range D, $I_{OUT} = 0A$, $V_{RCOMF} = (V_{EE} + 2.5V)$ and $(V_{CC} - 2.5V)$			0.001	0.005	%FSR/V
VOLTAGE MONITOR							
Measured Output Voltage Range	V_{DUTM}	Gain = +1, $IOSV = AGND$		$V_{EE} + 2.5$		$V_{CC} - 2.5$	V
Voltage-Sense-Amp Offset Voltage Input	V_{IOSV}	Relative to AGND		-0.2		+4.4	V
Voltage-Sense-Amp Measured Offset	V_{DUTMO}	Gain = +1				± 25	mV
Measured Voltage Offset Temperature Coefficient	$V_{DUTMOSTC}$				± 10		$\mu V/^{\circ}C$
	V_{DUTGE}	Gain = +1				± 1	%

($V_{CC} = +12V$, $V_{EE} = -12V$, $V_L = +3.3V$, $C_{C1} = 350pF$, $C_L = C_{MEAS} = C_{IMEAS} = 100pF$, $T_J = +30^{\circ}C$ to $+100^{\circ}C$; Typical values are at $T_J = +30^{\circ}C$, unless otherwise specified.) (Note 1, Note 2)

PARAMETER	SYMBOL	CONDITIONS		MIN	TYP	MAX	UNITS
Voltage-Sense-Amp Gain Error		Gain = +1/2				±1	
		Gain = +1/6				±1.75	
Measured-Voltage Gain Temperature Coefficient	V_{DUTGTC}				±10		ppm/°C
Linearity Error	V_{DUTLE}	(Note 4)	Gain and offset errors calibrated out, $V_{IOSV} = -0.2V$ and $+4.4V$, $I_{OUT} = 0A$, gain = +1, range B			±0.02	%FSR
VOLTAGE/CURRENT CLAMPS (Note 8)							
Input Control Voltage	$V_{CLO}-V_{CLHI}$			$V_{EE} + 2.3$		$V_{CC} - 2.3$	V
Voltage Clamp Range	V_{CRNG}	(Note 9)	DPS output current ≤ 10% of FSR	$V_{EE} + 2.5$		$V_{CC} - 2.5$	V
			DPS output current at FSR	$V_{EE} + 5$		$V_{CC} - 5$	
Voltage Clamp Gain	V_{CGAIN}				+1		V/V
Voltage Clamp Accuracy	V_{CERR}	(Note 2, Note 9)	Range A to D, $I_{OUT} \leq 10\%$ of FSR			±300	mV
			Range A to D, $I_{OUT} = \pm FSR$			±300	
Current Clamp Range	I_{CRNG}	(Note 10)			V_{IOSI} ±1.5 x FSR		V
Current Clamp Gain	I_{CGAIN}				4		V/FSR
Current Clamp Accuracy	I_{CERR}	(Notes 2, Note 10)	Range A, $V_{OUT} = \pm FSR$, $I_{OUT} = \pm FSR$			±0.15	%FSR
		(Note 10)	Range B to D, $V_{OUT} = \pm FSR$, $I_{OUT} = \pm FSR$			±0.05	
COMPARATOR INPUTS							
Input Voltage Range	CMP_{IRG}			$V_{EE} + 3.5$		$V_{CC} - 3.5$	V
Input Offset Voltage	CMP_{IOS}	$V_{ITHHI} = V_{ITHLO} = 0V$				±40	mV
COMPARATOR OUTPUTS							
Output High Voltage	CMP_{OH}	$V_L = 2.375V$ to $3.3V$, $R_{PULLUP} = 1k\Omega$		$V_L - 0.2$			V
Output Low Voltage	CMP_{OL}	$V_L = 2.375V$ to $3.3V$, $R_{PULLUP} = 1k\Omega$				0.4	V
High-Impedance State Leakage Current	CMP_{OLK}				±5		nA
High-Impedance Output Capacitance	CMP_{OC}				1		pF
ANALOG INPUTS							

($V_{CC} = +12V$, $V_{EE} = -12V$, $V_L = +3.3V$, $C_{C1} = 350pF$, $C_L = C_{MEAS} = C_{IMEAS} = 100pF$, $T_J = +30^{\circ}C$ to $+100^{\circ}C$; Typical values are at $T_J = +30^{\circ}C$, unless otherwise specified.) (Note 1, Note 2)

PARAMETER	SYMBOL	CONDITIONS	MIN	TYP	MAX	UNITS
Input Current	I_{IN}			± 5		A
Input Capacitance	C_{IN}			4		pF
DIGITAL INPUTS						
Input High Voltage	V_{IH}		$V_{THR} + 0.15$			V
Input Low Voltage	V_{IL}				$V_{THR} - 0.15$	V
V_{THR} Input Range	V_{THR}		0.5		$V_L - 0.5$	V
Input Current	I_{IN}			± 25		μA
Input Capacitance	C_{IN}			4		pF
DIGITAL OUTPUTS						
Output High Voltage	V_{OH}	$V_L = 2.375V$ to $3.3V$, relative to DGND, $I_{OUT} = +1.0mA$	$V_L - 0.25$			V
Output Low Voltage	V_{OL}	$V_L = 2.375V$ to $3.3V$, relative to DGND, $I_{OUT} = -1.0mA$			0.2	V
TEMPERATURE SENSOR						
Analog Output Offset	V_{TSNSO}	$T_J = +28^{\circ}C$		3.01		V
Analog Output Gain	V_{TSNSG}			10		mV/ $^{\circ}C$
Digital Output Temperature Threshold	T_{TSNSR}	(Note 11)		+130		$^{\circ}C$
Thermal-Shutdown Temperature	T_{SDN}			+140		$^{\circ}C$
POWER SUPPLY						
Positive Supply	V_{CC}	(Note 12)	12		20	V
Negative Supply	V_{EE}	(Note 12)	-15		-12	V
Total Supply Voltage	$V_{CC} - V_{EE}$				+30	V
Logic Supply	V_L		+2.375		+3.300	V
Positive Supply Current	I_{CC}	No load		20	22	mA
Negative Supply Current	I_{EE}	No load		19	21	mA
Analog Ground Current	I_{AGND}	No load		0.8	1	mA
Logic Supply Current	I_L	No load, all digital inputs at DGND		7.0	9.0	mA
Digital Ground Current	I_{DGND}	No load, all digital inputs at DGND		7.0	9.0	mA
Power-Supply Rejection Ratio	PSRR	Each supply varied individually from min to max, $V_{DUT} = 5.0V$		80		dB
FORCE VOLTAGE (Note 13, Note 14)						
Settling Time	FV_{ST}	Range D = $\pm 200\mu A$, $R_L = 35k\Omega$ to AGND		30		μs
		Range C = $\pm 2mA$, $R_L = 35k\Omega$ to AGND		20		
		Range B = $\pm 20mA$, $R_L = 350\Omega$ to AGND		30	50	
		Range A = $\pm 1200mA$, $R_L = 0.5\Omega$ to AGND		25		

($V_{CC} = +12V$, $V_{EE} = -12V$, $V_L = +3.3V$, $C_{C1} = 350pF$, $C_L = C_{MEAS} = C_{IMEAS} = 100pF$, $T_J = +30^{\circ}C$ to $+100^{\circ}C$; Typical values are at $T_J = +30^{\circ}C$, unless otherwise specified.) (Note 1, Note 2)

PARAMETER	SYMBOL	CONDITIONS	MIN	TYP	MAX	UNITS	
LOAD REGULATION SETTling TIME (Note 14)							
Settling Time	LR_{ST}	Range A, $V_{IN} = \pm 7V$, $R_L = 0.5\Omega$ switched between open circuit to AGND, $C_L = 10\mu F$		100		μs	
FORCE VOLTAGE/MEASURE CURRENT (Note 13, Note 14, Note 15)							
Settling Time	$FVM_{I_{ST}}$	Range D = $\pm 200\mu A$, $R_L = 35k\Omega$ to AGND		50		μs	
		Range C = $\pm 2mA$, $R_L = 35k\Omega$ to AGND		20			
		Range B = $\pm 20mA$, $R_L = 350\Omega$ to AGND		25	50		
		Range A = $\pm 1200mA$, $R_L = 0.5\Omega$ to AGND		35			
FORCE CURRENT (Note 13, Note 14)							
Settling Time	FI_{ST}	Range D = $\pm 200\mu A$, $R_L = 35k\Omega$ to AGND		100		μs	
		Range C = $\pm 2mA$, $R_L = 35k\Omega$ to AGND		35			
		Range B = $\pm 20mA$, $R_L = 350\Omega$ to AGND		25	50		
		Range A = $\pm 1200mA$, $R_L = 0.5\Omega$ to AGND		20			
FORCE CURRENT/MEASURE VOLTAGE (Note 13, Note 14, Note 15)							
Settling Time	$FIMV_{ST}$	Range D = $\pm 200\mu A$, $R_L = 35k\Omega$ to AGND		100		μs	
		Range C = $\pm 2mA$, $R_L = 35k\Omega$ to AGND		35			
		Range B = $\pm 20mA$, $R_L = 350\Omega$ to AGND		25	50		
		Range A = $\pm 1200mA$, $R_L = 0.5\Omega$ to AGND		40			
FORCE OUTPUT							
Output Slew Rate	FO_{SLEW}	(Note 16)	$C_L = 0F$	0.5	1.4	2.3	$V/\mu s$
Stable Load Capacitance Range	FO_{SLC}	(Note 17, Note 18)				1000	μF
Output Overshoot	FO_{OSHT}	$C_L < 20\mu F$, $CB1 = 3nF$			0		%
MEASURE OUTPUT							
Stable Load Capacitance Range	MO_{SLC}	(Note 17)				1000	pF
COMPARATORS (CILIMHI/LIMLO = 20pF, $R_{PULLUP} = 1k\Omega$) (Note 19)							
Propagation Delay	CMP_{PD}	100mV overdrive, $1V_{P-P}$, measured from input threshold zero crossing to 50% of output voltage			100		ns
Rise Time	CMP_{TR}	20% to 80%			80		ns
Fall Time	CMP_{TF}	20% to 80%			5		ns
Disable True to High Impedance	CMP_{HIZT}	Measured from 50% of digital input voltage to 10% of output voltage			100		ns
Disable False to Active	CMP_{HIZF}	Measured from 50% of digital input voltage to 90% of output voltage			100		ns
SERIAL PORT TIMING CHARACTERISTICS ($V_L = 3.0V$, $C_{DOUT} = 10pF$) (Timing Diagram)							
Serial Clock Frequency	f_{SCLK}					20	MHz
SCLK Pulse-Width High	t_{CH}				12		ns

($V_{CC} = +12V$, $V_{EE} = -12V$, $V_L = +3.3V$, $C_{C1} = 350pF$, $C_L = C_{MEAS} = C_{IMEAS} = 100pF$, $T_J = +30^{\circ}C$ to $+100^{\circ}C$; Typical values are at $T_J = +30^{\circ}C$, unless otherwise specified.) (Note 1, Note 2)

PARAMETER	SYMBOL	CONDITIONS	MIN	TYP	MAX	UNITS
SCLK Pulse-Width Low	t_{CL}		12			ns
SCLK Fall to DOUT Valid	t_{DO}				25	ns
\overline{CS} Low to SCLK High Setup	t_{CSS0}		10			ns
SCLK High to \overline{CS} High Hold	t_{CSH1}		22			ns
SCLK High to \overline{CS} Low Hold	t_{CSH0}	(Note 17)	0			ns
\overline{CS} High to SCLK High Setup	t_{CSS1}		5			ns
DIN to SCLK High Setup	t_{DS}		10			ns
DIN to SCLK High Hold	t_{DH}		0			ns
\overline{CS} Pulse-Width High	t_{CSWH}		10			ns
\overline{CS} Pulse-Width Low	t_{CSWL}		10			ns
\overline{LOAD} Pulse-Width Low	t_{CLL}		20			ns
Power-on Reset	POR			50		μs

- Note 1:** All minimum and maximum test limits are 100% production tested at $T_J = +35^{\circ}C \pm 15^{\circ}C$ at nominal supplies. Specifications over the full operating temperature range are guaranteed by design and characterization.
- Note 2:** Exercise care not to exceed the maximum power dissipation specifications listed in the Absolute Maximum Ratings section. With a drive current of $\pm 1200mA$, limit DPS operation to two quadrants (i.e., when sourcing current limit V_{DUT} to below $+7V$, when sinking current limit V_{DUT} to above $-7V$). With a drive current below $\pm 1200mA$ and four-quadrant operation, limit DPS power dissipation to below the allowed maximum.
- Note 3:** V_{IN} swept to achieve an output voltage of $(V_{EE} + 2.5V)$ to $(V_{CC} - 2.5V)$, with $I_{OUT} = 0A$.
- Note 4:** Parameters expressed in terms of %FSR (percent of full-scale range) are as a percent of the end-point-to-end-point range.
- Note 5:** Case must be maintained to within $\pm 5^{\circ}C$ for linearity specifications to apply.
- Note 6:** Load regulation is defined at a single programmed output voltage (force voltage mode), independent of linearity specification, with a 0 to 100% current step.
- Note 7:** To maintain linearity, keep the clamps at least 700mV away from V_{RCOMF} .
- Note 8:** In the force-current and force-voltage modes, the reference-clamping voltage CLH must be greater than 0V, and CLL must be less than 0V. For high clamping accuracy, $CLH - CLL > 1V$. To maintain 0.02% force-voltage linearity when the programmable current clamps are enabled, two conditions must be met: 1) CLH and CLL must be set 12.5% FSR higher than the forced current and 2) CLH and CLL must be set such that $CLH \geq 1.6V + IOSI$ and $CLL \leq -1.6V + IOSI$ (e.g., if driving $\pm 1mA$ in the 2mA range, the current clamps must be set to a minimum of $\pm 1.5mA$, or $CLH = 3V$, $CLL = -3V$, and $IOSI = 0V$).
- Note 9:** DPS in force current mode.
- Note 10:** DPS in force voltage mode.
- Note 11:** The temperature threshold may vary up to $\pm 10^{\circ}C$ from the specified threshold.
- Note 12:** The device operates properly within absolute specifications, for varying supply voltages with equally varying output voltage settings.
- Note 13:** Settling times are for a full-scale voltage or current step. FV_{ST} measured from V_{IN} to V_{DUT} , $FVMI_{ST}$ from V_{IN} to I_{MEAS} , FI_{ST} from V_{IN} to V_{DUT} , and $FIMV_{ST}$ from V_{IN} to V_{MEAS} .
- Note 14:** Settling times are to 0.1% of FSR.

Note 15: The actual settling time of the measure path (sense input to measure output) is less than 1 μ s. However, the RC time constant of the sense resistor and the load capacitance causes a longer overall settling time of V_{DUT} . This settling time is a function of the current range resistor.

Note 16: Slew rate is measured from the 20% to 80% points.

Note 17: Guaranteed by design and characterization.

Note 18: Range A.

Note 19: The propagation delay time is measured by holding the current constant and transitioning ITHHI or ITHLO.

Timing Diagrams

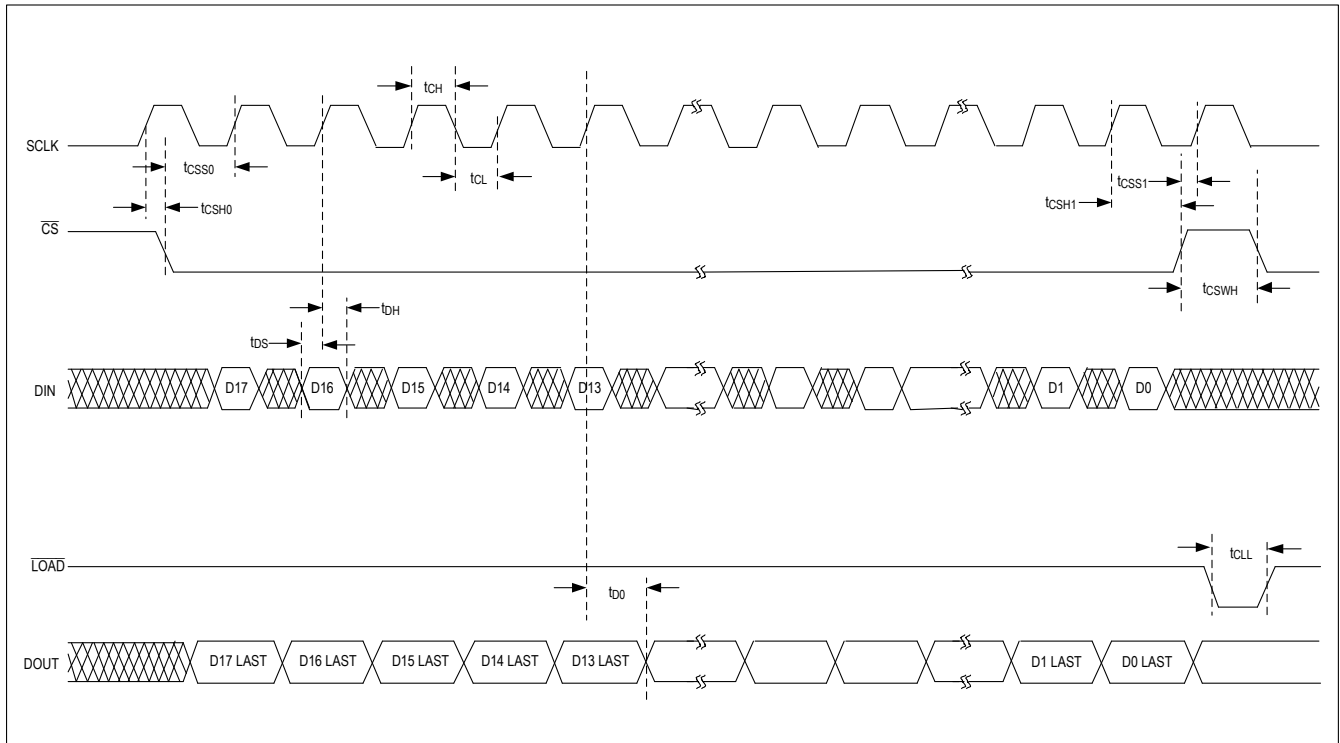

Typical Operating Characteristics

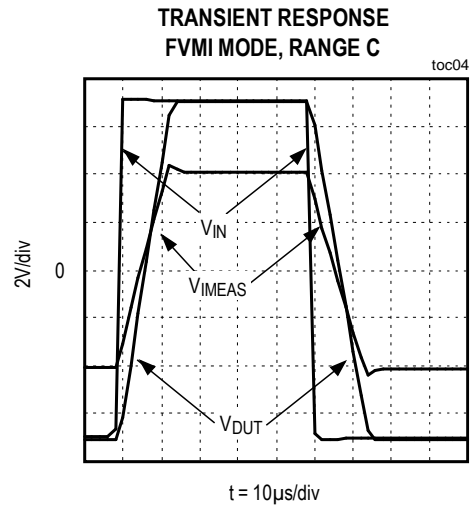
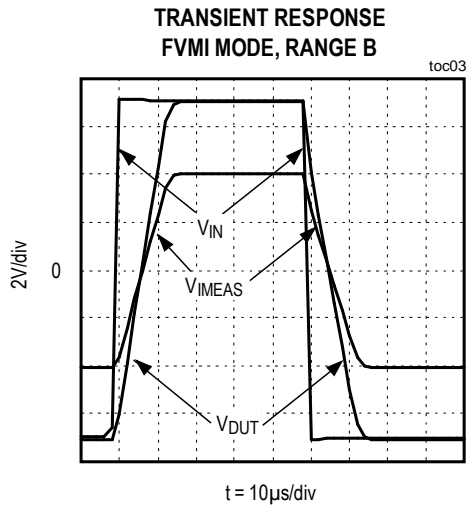
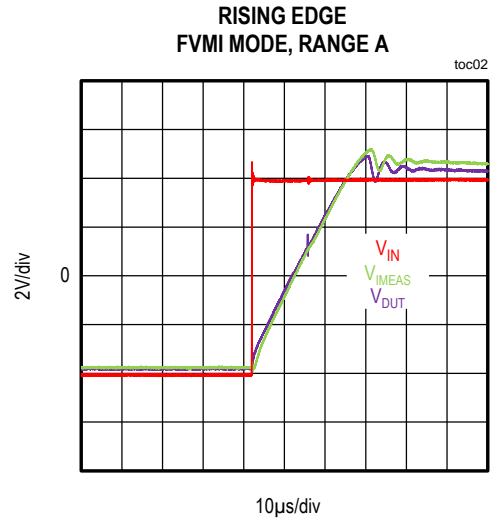
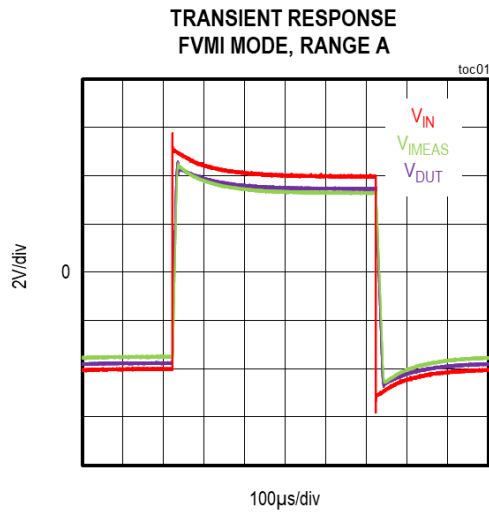

TRANSIENT RESPONSE
FVMI MODE, RANGE D

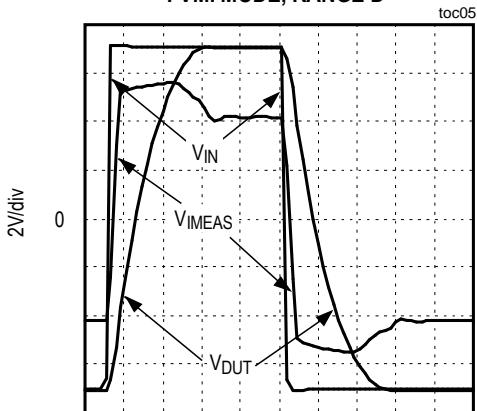

t = 15µs/div

TRANSIENT RESPONSE
FVMV MODE, RANGE C

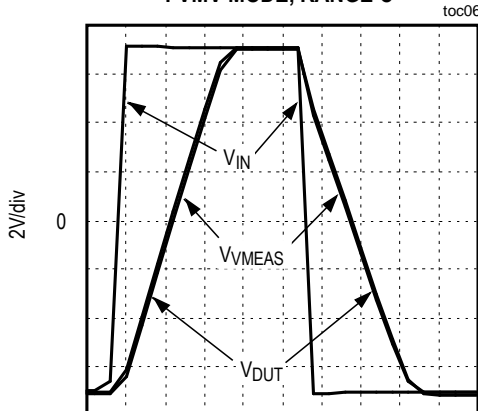

t = 5µs/div

TRANSIENT RESPONSE
FIMV MODE, RANGE A

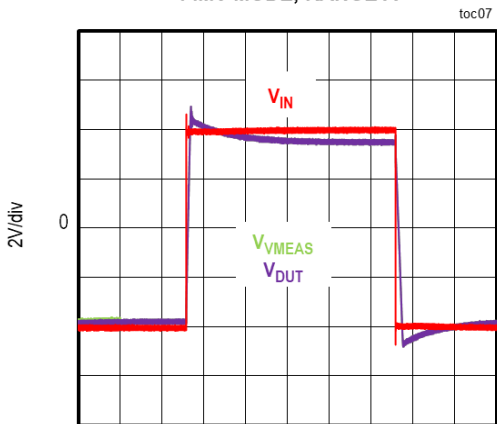

100µs/div

RISING EDGE
FIMV MODE, RANGE A

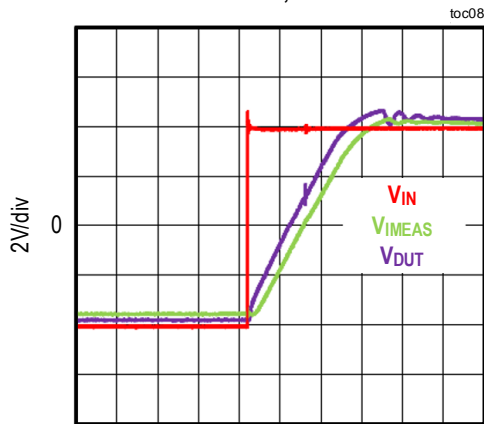

10µs/div

TRANSIENT RESPONSE
FIMV MODE, RANGE B

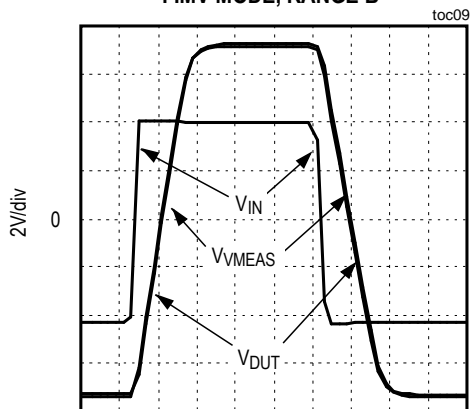

t = 10µs/div

TRANSIENT RESPONSE
FIMV MODE, RANGE C

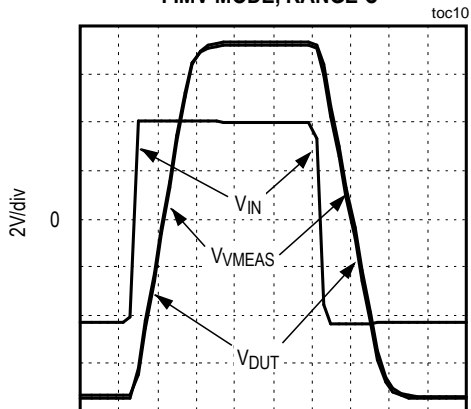

t = 10µs/div

TRANSIENT RESPONSE
FIMV MODE, RANGE D

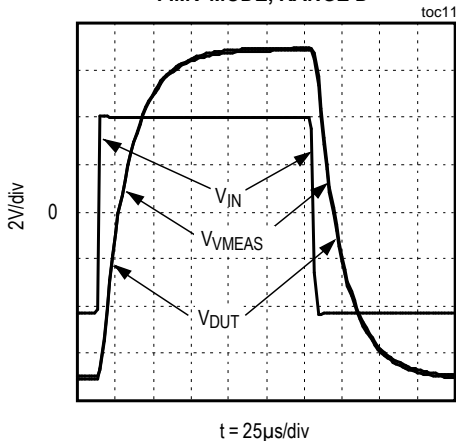

TRANSIENT RESPONSE
FIMI MODE, RANGE C

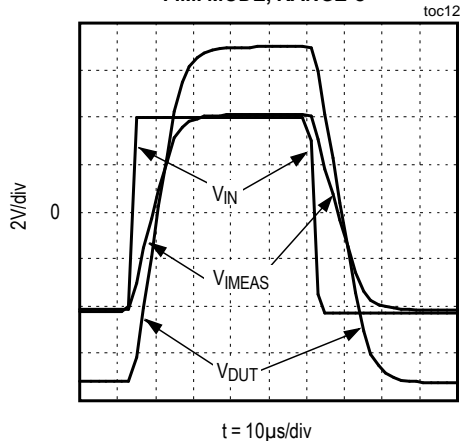

LOAD REGULATION
TRANSIENT RECOVERY

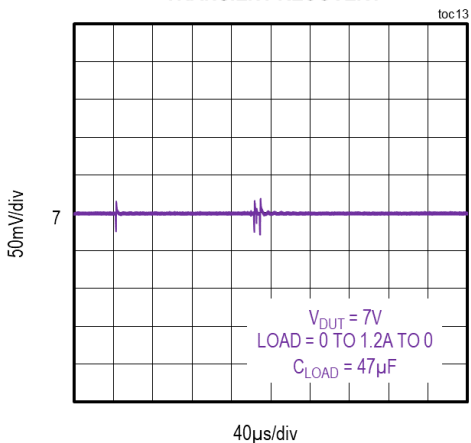

LOAD REGULATION
TRANSIENT RECOVERY

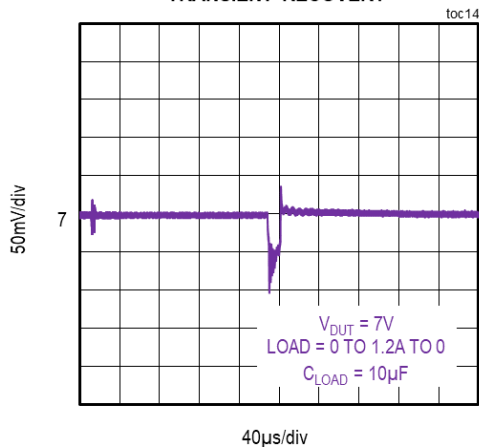

RESPONSE TO CAPACITIVE LOAD
FALLING EDGE

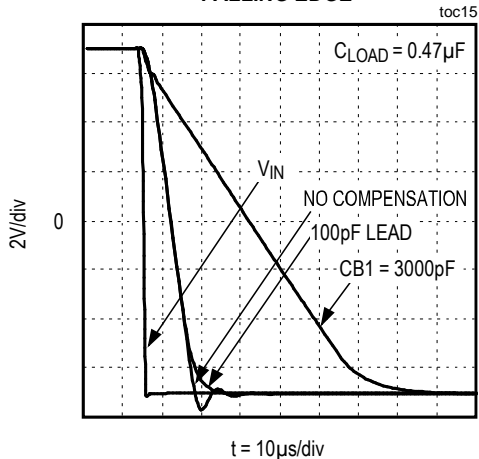

RESPONSE TO CAPACITIVE LOAD
POSITIVE SIGNAL

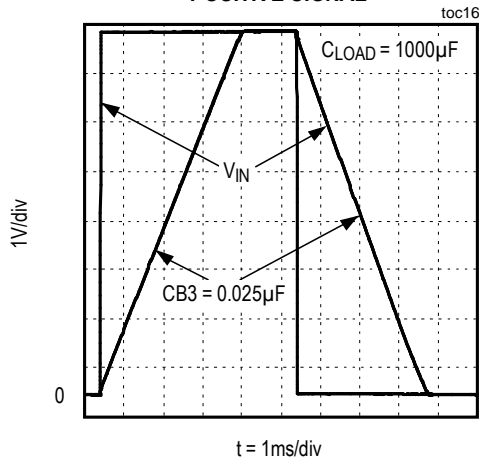

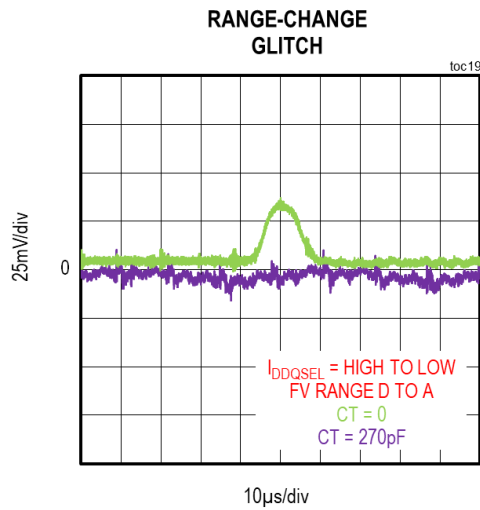
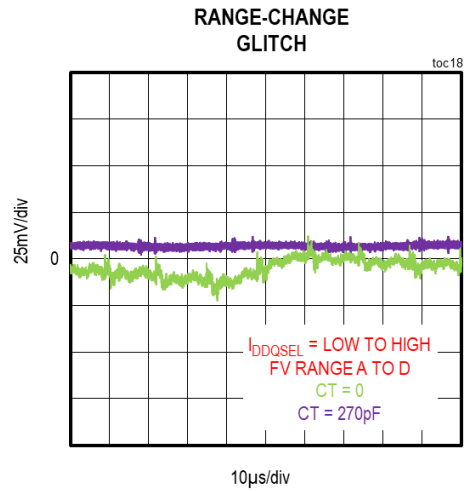
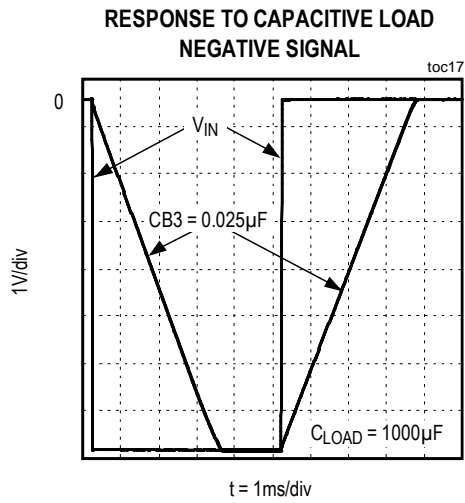

Pin Configurations

TOP VIEW

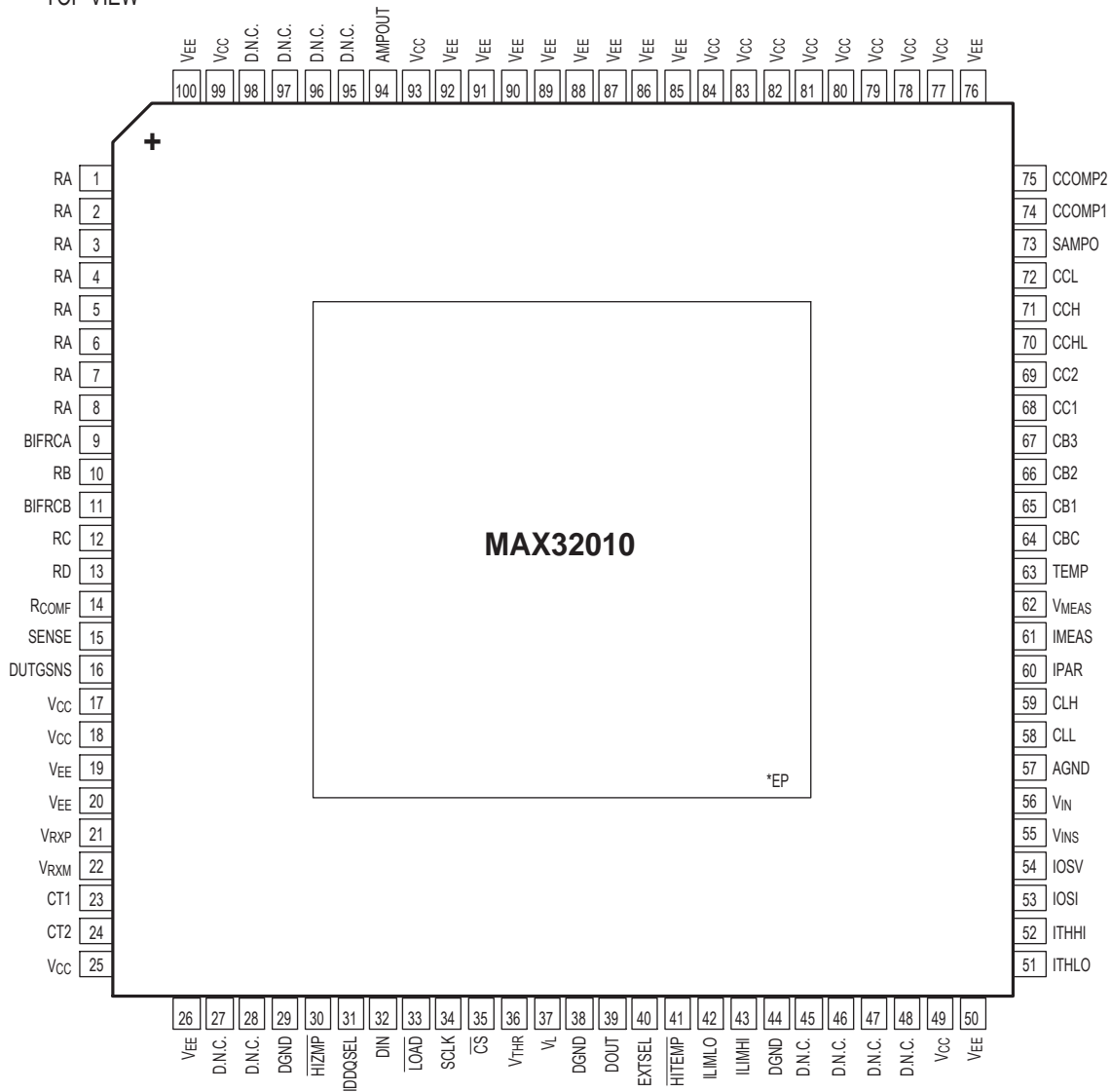

TQFP

Pin Descriptions

PIN	NAME	FUNCTION
1–8	RA	Range A Outputs. Connect together and to a range-setting resistor.
9	BIFRCA	Positive Current-Sense-Amplifier Input. Used in range A to provide a Kelvin connection to a range-setting resistor.
10	RB	Range B Output. Connect to a range-setting resistor.
11	BIFRCB	Positive Current-Sense-Amplifier Input. Used in range B to provide a Kelvin connection to a range-setting resistor.
12	RC	Range C Output. Connect to a range-setting resistor.
13	RD	Range D Output. Connect to a range-setting resistor.

14	R _{COMF}	Sense Resistors Kelvin Connection. The Kelvin connection for the sense resistors that connect to the DUT. R _{COMF} provides a feedback point for current sensing.
15	SENSE	Sense Input. Kelvin connection to the DUT. Provides the feedback signal for FVMI and the measured signal for FIMV.
16	DUTGSNS	DUT Ground Sense. In force voltage (FV) mode, it senses the error between AGND and DUTGND and adjusts the output voltage to achieve the desired voltage drop across the DUT with respect to DUTGND.
17, 18, 25, 49, 77–84, 93, 99	V _{CC}	Positive Analog Supply. It is recommended to connect all V _{CC} pins together.
19, 20, 26, 50, 76, 85–92, 100	V _{EE}	Negative Analog Supply. It is recommended to connect all V _{EE} pins together.
21	V _{RXP}	Positive Current-Sense-Amplifier Input. Used in the external range to provide a Kelvin connection to the range-setting resistor.
22	V _{RXM}	Negative Current-Sense-Amplifier Input. Used in the external range to provide a Kelvin connection to the range-setting resistor.
23	CT1	Range-Change Glitch-Control Capacitor Connection. Connect optional capacitor from CT1 to DGND.
24	CT2	Range-Change Glitch-Control Capacitor Connection. Connect optional capacitor from CT2 to DGND.
27, 28, 45–48, 95, 96, 97, 98	D.N.C.	Do Not Connect. Make no connection to these pins. Even a connection to AGND/DGND should not be made.
29, 38, 44	DGND	Digital Ground. It is recommended to connect all of the DGND pins together. Connect DGND to AGND on PCB.
30	HIZMP	High-Impedance Control Input. Places current and voltage measure outputs into a high-impedance state.
31	IDDQSEL	I _{DDQ} Test Select. In FV mode, switches between the programmed current range and range D, the lowest current range.
32	DIN	Data Input. Serial interface data input.
33	LOAD	Load Data Input. A falling edge at LOAD transfers data from the input registers to the DPS registers.
34	SCLK	Serial Clock Input. Serial interface clock.
35	CS	Chip-Select Input
36	V _{THR}	Threshold Voltage Input. Sets the input logic threshold level of all digital inputs. Defaults to 1/2 V _L if unconnected.
37	V _L	Logic Power Supply
39	DOUT	Data Output. Serial interface data output.
40	EXTSEL	External Select Output. Selects the external range.
41	HITEMP	High Temperature Indicator Output. Open-collector output goes low when the temperature of the die is above the specified safe operating temperature.
42	ILIMLO	Low Current-Limit Output. A sensed current below the ITHLO level forces the ILIMLO output low. ILIMLO is an open-drain output.
43	ILIMHI	High Current-Limit Output. A sensed current above the ITHHI level forces the ILIMHI output low. ILIMHI is an open-drain output.
51	ITHLO	Low Current-Limit Input. Voltage input that sets the lower threshold for the sense current comparator.
52	ITHHI	High Current-Limit Input. Voltage input that sets the upper threshold for the sense current comparator.
53	IOSI	Current-Sense Offset Voltage Input. Voltage input that sets an offset voltage for the current-sense amplifier in either FI or MI mode.
54	IOSV	Measurement Offset Voltage Input. Voltage input that sets an offset voltage for the measurement voltage amplifier.
55	V _{INS}	Forced-Current Input. Voltage input that sets the forced current in FI slave mode.
56	V _{IN}	Forced-Current/Voltage Input. Voltage input that sets the forced current in FI mode or forced voltage in FV mode.
57	AGND	Analog Ground. Connect AGND to DGND on PCB.
58	CLL	Compliance Low Input. Voltage input that sets the low-side voltage/current compliance.

59	CLH	Compliance High Input. Voltage input that sets the high-side voltage/current compliance.
60	IPAR	Current-Controlled Proportional Voltage Output. IPAR outputs a voltage that is proportional to the DUT current. Used to slave additional parallel DPSs to provide increased output current.
61	IMEAS	Current-Controlled Proportional Voltage Output. IMEAS outputs a voltage that is proportional to the DUT current. High impedance when HIZMP is forced low.
62	V _{MEAS}	Voltage-Controlled Proportional Voltage Output. V _{MEAS} outputs a voltage equal to 1x, 1/2x, or 1/6x the voltage present at SENSE. High impedance when HIZMP is forced low.
63	TEMP	Temperature Monitor Output. TEMP outputs a voltage proportional to a die temperature of 10mV/K.
64	CBC	CB Common. Common point for bypass capacitor connections CB1, CB2, and CB3.
65	CB1	Bypass Capacitor 1. Compensation capacitor 1 connection.
66	CB2	Bypass Capacitor 2. Compensation capacitor 2 connection.
67	CB3	Bypass Capacitor 3. Compensation capacitor 3 connection.
68	CC1	Main Compensation Capacitor. Compensation capacitor connection 1.
69	CC2	Main Compensation Capacitor. Compensation capacitor connection 2.
70	CCHL	Clamp Compensation Capacitor Common. Common connection for CCL and CCH.
71	CCH	High Clamp Compensation Capacitor. High-side voltage clamp compensation capacitor connection.
72	CCL	Low Clamp Compensation Capacitor. Low-side voltage clamp compensation capacitor connection.
73	SAMPO	Lead Compensation Capacitor Common. Common connection for CCOMP1 and CCOMP2.
74	CCOMP1	Compensation Capacitor 1. Lead compensation capacitor 1 connection.
75	CCOMP2	Compensation Capacitor 2. Lead compensation capacitor 2 connection.
94	AMPOUT	Main Amplifier Output. Drives the external buffer when in external range mode.
—	EP	Exposed pad. Internally connected to V _{EE} . Connect to a large V _{EE} power plane or heatsink to maximize thermal performance. Not intended as an electrical connection point and should not be connected to AGND/DGND.

Functional Diagram

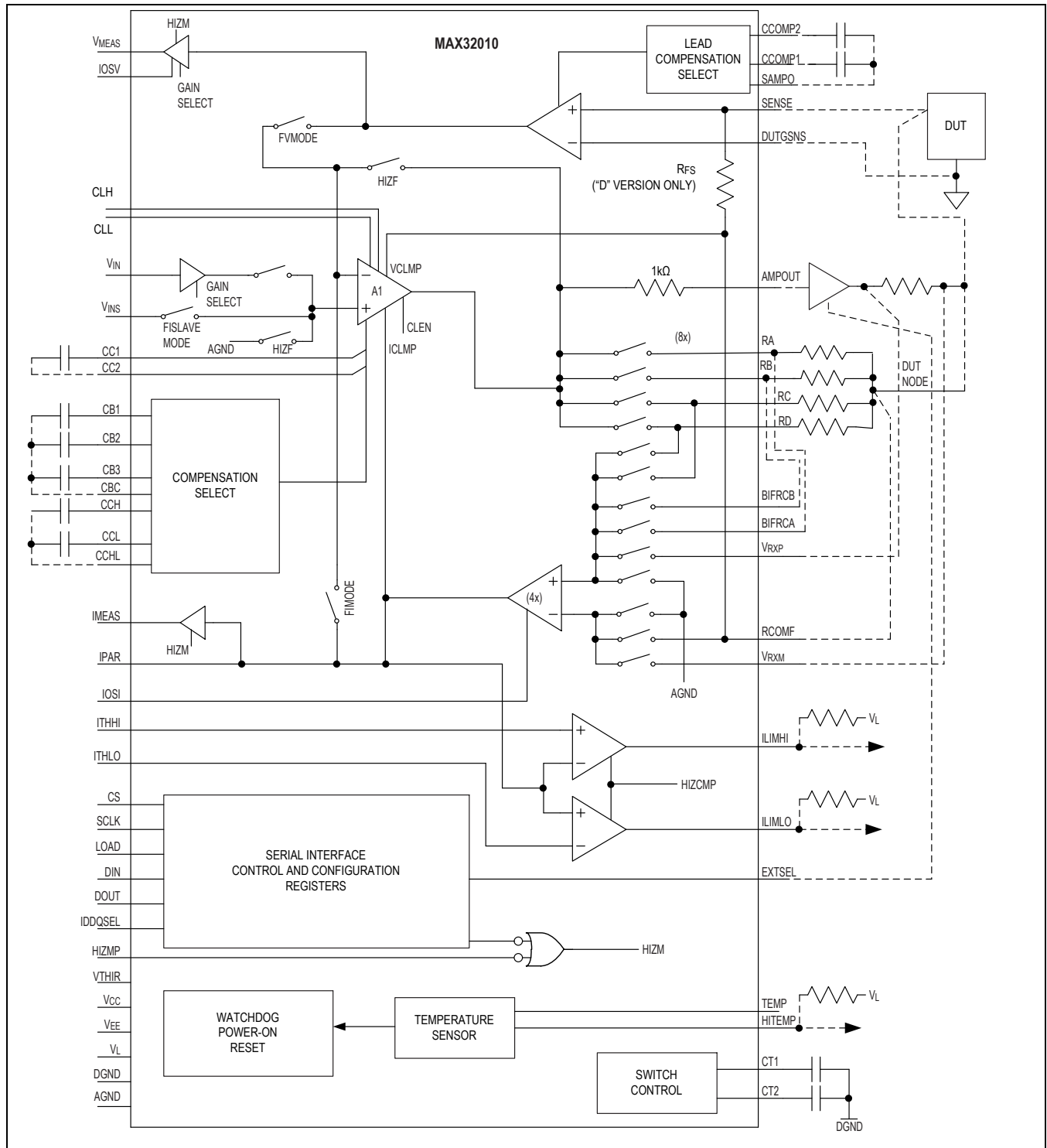

Detailed Description

The MAX32010 provides all of the key features of a device power supply (DPS) common to automated test equipment (ATE) and other instrumentation. Its small size, high level of integration, and superb flexibility make the MAX32010 ideal and economical for multisite systems requiring many device power supplies. It has multiple input control voltages that allow independent setting of the output voltage, and voltage/current limits. The device acts a voltage source when the load current is between the two programmed limits, and transitions gracefully into a precision current source/sink if a programmed current limit is reached. The output features two independently adjustable voltage clamps that limit both the negative and positive output voltage. The MAX32010 can source voltages spanning 25V and can source currents as high as $\pm 1200\text{mA}$. The DPS can support an external buffer for sourcing and sinking higher currents. Multiple MAX32010s can be configured in parallel to load-share, allowing higher output currents with greater flexibility. The DPS features operation over a wide range of load conditions. Programmability allows optimizing of settling time, over-/undershoot, and stability. Configurable range-change glitch control circuit minimizes output transients during range transitions.

Analog Signal Polarities

In force-voltage mode, the output voltage (SENSE/RCOMF in the *Functional Diagram*) is proportional to the input control voltage and determined by the choice of one of three \pm gain settings controlled through the serial interface.

In force-current mode, the output current is proportional to the input control voltage and behaves according to the formula:

$$I_{\text{OUT}} = \frac{V_{\text{IN}}}{4 \times R_{\text{SENSE}}}$$

Positive current is defined as flowing out of the MAX32010 DPS. In high-impedance mode, outputs RA, RB, RC, and RD are high impedance.

Current-Sense-Amplifier Offset Voltage Input

The current-sense amplifier monitors the voltage across the output resistors connected to RA, RB, RC, and RD as seen in the *Functional Diagram*. The current-sense offset voltage input (IOSI) introduces an offset to the current-sense amplifier. When IOSI is zero relative to AGND, the nominal output voltage range of the current-sense amplifier corresponding to a \pm full-scale output current is -4V to $+4\text{V}$. Voltage applied to IOSI adds directly to this output voltage. For example, if $+4\text{V}$ is applied to IOSI, the voltage range corresponding to \pm full-scale current becomes 0 to $+8\text{V}$ within the range allowed by the power-supply rails.

Measurement Voltage-Sense-Amplifier Offset Voltage Input

The measurement voltage-sense amplifier monitors the output voltage of the MAX32010. The measurement offset voltage input, IOSV, introduces an offset to the measurement voltage amplifier. Voltage applied to IOSV adds directly to this output voltage.

External Mode Support

The MAX32010 includes resources to drive an external amplifier to provide a current range beyond the highest range (or below the lowest current range) included within the device. A voltage output, AMPOUT, is provided for the input of the external amplifier, and a digital output, EXTSEL, goes high to activate the external amplifier. Feedback inputs V_{RXP} and V_{RXM} connect across the external amplifier's current-sense resistor. The external amplifier must have a high-impedance output when not selected (EXTSEL = low), if connected as shown in the *Functional Diagram*.

Parallel DPS Operation

The MAX32010 allows multiple devices to be configured in parallel to increase the available device under test (DUT) drive current. One DPS must be configured as the master (in FV mode), and the parallel devices must be configured as slaves (in FI slave mode). The connection between the master and slaves is made using the IPAR output and V_{INS} input. IPAR outputs a voltage that is proportional to the DUT current and V_{INS} provides a proportional force-current/voltage input. Up to 16 MAX32010 devices can be placed in parallel.

Voltage Clamps

Internal programmable voltage clamps limit the output voltage to the programmed values when in FI mode. Set the clamp voltage limits with inputs CLH and CLL. The clamps handle the full $\pm 1200\text{mA}$ and are triggered by the voltage at R_{COMF} independent of the voltage at SENSE. The clamp-enable bit, CLEN, in the serial control word, enables the voltage clamps. The following formulae can be used to calculate values of inputs CLH and CLL:

$$V_{CLH} = V_{CLHTARGET} + V_{IOSI}$$

$$V_{CLL} = V_{CLLTARGET} + V_{IOSI}$$

Where, $V_{CLHTARGET}$ is the clamp-high target voltage. The V_{CLH} value is recommended to be a minimum of +0.5V to maintain the FI linearity, and $V_{CLLTARGET}$ is the clamp-low target voltage. The V_{CLL} value is recommended to be a maximum of -0.5V to maintain the FI linearity. Both the V_{CLH} and V_{CLL} values are independent of the VGA setting ($\pm 1x$, $\pm 2x$, or $\pm 6x$).

Example: V_{IN} is programmed to 3.000V with the VGA setting at +2x and $V_{IOSI} = 0V$, resulting in a DUT output voltage of +6.000V. V_{CLH} should be set to +6.0V, and V_{CLL} should be set to -0.5V.

Current Limit

Programmable and default current limits are available at the output in the FI and FV modes. When programmable current compliance is enabled, the DPS output current limits at the preprogrammed setting for each current range. When the current limit is disabled, the DPS output current limits at the default value, 147% FSR (typ), of the selected current ranges for range B, C, and D. In range A under FI or FV conditions, the DPS output current is limited at 138% FSR (typ). For currents within each selected range, the FV output behaves as a constant voltage source. When the default or programmed current compliance limits are reached, the DPS transitions to constant current mode.

To set the current clamps in FV mode, enable the clamps by setting the CLEN bit in the control register. The values of CLH and CLL can be calculated by using the following formulae:

$$V_{CLH} = I_{CLHTARGET} \times 1.18 \times 4 \times R_{SENSE} + V_{IOSI}$$

$$V_{CLL} = I_{CLLTARGET} \times 1.18 \times 4 \times R_{SENSE} + V_{IOSI}$$

The value 1.18 translates to the 18% current clamp headroom to maintain FV linearity.

$I_{CLHTARGET}$ is the clamp-high target current. The V_{CLH} value is recommended to be a minimum of +1.6V to maintain the FV linearity. $I_{CLLTARGET}$ is the clamp-low target current. The V_{CLL} value is recommended to be a maximum of -1.6V to maintain the FV linearity.

Example: $I_{CLHTARGET} = 1.000A$, $R_{SENSE} = 0.5\Omega$ (range A), $V_{IOSI} = 0V$. V_{CLH} should be set to +2.36V, and V_{CLL} should be set to -1.6V.

Current-Limit Flags

The MAX32010 can flag currents within user-specified limits. This allows fast go/no-go testing in production environments. The window comparator continuously monitors the load current and compares it to inputs ITHHI and ITHLO. The comparator outputs are open collector and can be made high impedance with the serial interface.

Measure Amplifier High-Impedance Modes

Measure outputs V_{MEAS} and $IMEAS$ can be placed in a high-impedance state with the logic input \overline{HIZMP} or the serial interface bit \overline{HIZMS} . This allows busing of the measure outputs with other DPS measure outputs.

Ground and DUT Ground Sense

Two ground connections, AGND (analog ground) and DGND (digital ground), are both local grounds. Connect these grounds together on the printed circuit board (PCB). The DUT ground-sense input, DUTGSNS, allows sensing with respect to the DUT in force voltage mode.

Short-Circuit Protection

RA, RB, RC, RD, AMPOUT, and SENSE can withstand a short to any voltage between and including the supply rails.

Temperature Sensor and Overtemperature Protection

The MAX32010 outputs a voltage proportional to its die temperature, at TEMP, of 10mV/K (or 10mV/°C) with the nominal output voltage being 3.43V at 343K (+70°C). If the temperature of the die enters the range of +120°C to +140°C, the open-collector output HITEMP goes low. If the die temperature exceeds +140°C, the temperature sensor issues a power-on reset, placing the DPS into its high-impedance state. A reduction in temperature after a temperature-initiated reset does not return the DPS to its original operating state; reprogramming is required.

Mode and Range-Change Transients

Glitch minimization measures in the MAX32010 employ make-before-break switching and internal clamps to reduce output glitches. To guarantee minimum glitches between range changes, change between adjacent ranges (e.g., RA to

RB, RD to RC). Do not switch to another range until the present range-change operation has been completed. In addition to the make-before-break measures, connections CT1 and CT2 are provided for optional capacitors that control the edge rate of the gate drive to the range-change switches. Two capacitors of 150pF each provide a reasonable balance between glitch control and range-change transition time.

DUT Voltage Swing vs. DUT Current and Power-Supply Voltages

The DUT voltage that the MAX32010 can deliver is limited by two main and two lesser factors:

1. The 2.5V overhead from each supply rail required by the amplifiers and other on-chip circuitry
2. The voltage drop across the sense resistor and internal circuitry in series with the sense resistor. At full current, the combined voltage drop is 2.5V: 1V across the resistor and 1.5V across the switches. This voltage is not all in addition to the overhead requirement. There is some overlap of the two effects; see **Figure 1**.
3. Variations in the system power-supply voltages.
4. Variations between the ground voltage of the DUT and AGND.

Neglecting the effects of factors 3 and 4, the output capabilities of the DPS are demonstrated by **Figure 1**.

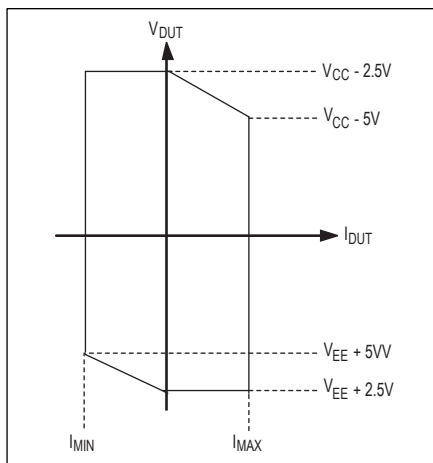

Figure 1. Output Swing

Figure 1 shows that, for zero DUT current, the DUT voltage swing is from $(V_{EE} + 2.5V)$ to $(V_{CC} - 2.5V)$. For positive DUT currents, the maximum voltage drops off linearly until it reaches $V_{CC} - 5V$ at full current. Similarly, for negative DUT currents, the magnitude of the negative voltage drops off linearly until it reaches $V_{EE} + 5V$. When the DPS is driving more than $\pm 200mA$ output current, the power dissipated by the DPS must be limited to below the power limit of the package (see the *Absolute Maximum Ratings* and *Note 2*). For example, when the DPS is driving $\pm 1200mA$ in range A, the V_{CC} supply must not exceed +12V and the V_{EE} supply must not exceed -12V. When the DPS is sourcing current, the DUT node must not be driven below 0V. When the DPS is sinking current, the DUT node must not be driven above 0V (two-quadrant operation). When operating below $\pm 1200mA$, four-quadrant operation may be possible depending on the power dissipation of the DPS. Power dissipation analysis must consider variations in the power-supply voltage and the voltage difference between the DUT ground and the DPS AGND (factors 3 and 4).

Since the maximum output voltage range is relative to the supply voltage, any decrease in a supply voltage from nominal proportionally decreases the range. The maximum output voltage range is also reduced by the difference between the DUT ground and the analog ground potentials (DUTGSNS - AGND). Note that, within these limitations, the forced DUT voltage is equal to DUT ground plus the input control voltage. Similarly, when measuring a voltage, the measured voltage is equal to the difference between the DUT voltage and DUT ground.

Configuration and Control

Configuration of the MAX32010 is achieved through the serial interface, and through the dedicated logic-control inputs $\overline{\text{HIZMP}}$, $\overline{\text{LOAD}}$, and IDDQSEL .

The serial interface has a shift register, an input register, and a DPS register (**Figure 2**). Serial data does not directly affect the DPS until the data reaches the DPS register. Control of data flow to the DPS register is through two control bits (A0 and C0) and the logic input ($\overline{\text{LOAD}}$). $\overline{\text{LOAD}}$ asynchronously transfers data from the input register into the DPS register. If $\overline{\text{LOAD}}$ is held low when data is latched into the input register, then the data transfers directly (transparently) into the DPS register. This allows changing the state of the DPS coincident with the end of serial-port data communication, or asynchronously with respect to serial-port communications. Asynchronous update using $\overline{\text{LOAD}}$ facilitates simultaneous updates of multiple daisy-chained DPS devices.

DPS Data Control Bits

An 18-bit word programs the MAX32010. **Table 1** outlines the 18-bit control word structure.

Serial Interface Data Flow Control Bits

Bits 0 and 1 (C0 and A0) specify if and how data transfers from the shift register to the input and DPS registers. The specified actions shown in **Table 2** occur when $\overline{\text{CS}}$ goes high (**Figures 3** and **4**).

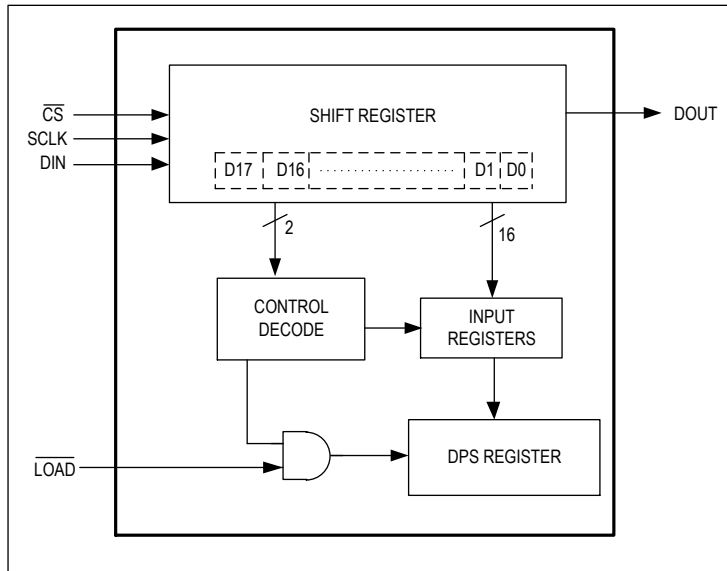

Figure 2. Serial Interface

When $\text{A0} = \text{C0} = 0$ (NOP), data moves through the shift register to **DOUT** without a change in mode or operation. This is useful when daisy-chaining devices to shift operational data through a number of devices to a specific device without altering some or all the device's operational data. To update multiple daisy-chained devices simultaneously, use $\text{A0} = 1$ and $\text{C0} = 0$ to load the input register of the devices to be updated and activate $\overline{\text{LOAD}}$ after $\overline{\text{CS}}$ goes high (**Figure 4**). If $\overline{\text{LOAD}}$ is held low while $\overline{\text{CS}}$ is raised, data latched to the input register is also latched to the DPS register, independent of the state of C0 .

Table 1. Data Control Bits and Bit Order

DATA BIT	NAME	FUNCTION
17	FMODE	Mode Select
16	G2	Gain and Polarity Select
15	G1	
14	G0	
13	RS2	Range Select
12	RS1	
11	RS0	
10	CLEN	Clamp Enable
9	RESERVED	Reserved. Set this bit to zero.
8	HIZFRC	Force High-Impedance Select
7	HIZMS	Measure High-Impedance Select
6	HIZCMP	Comparator High-Impedance Select
5	LCOMP1	Compensation Select
4	LCOMP0	
3	BCOMP1	
2	BCOMP0	
1	A0	Serial Interface Data Flow Control
0	C0	

Table 2. Serial Interface Data Flow Control Bits

DATA BITS		OPERATION
A0 (D1)	C0 (D0)	
0	0	NOP: Input and DPS registers remain unchanged
0	1	Load DPS register from input register
1	0	Load input register from shift register
1	1	Load input register and DPS register from shift register

“Quick Load” Using Chip Select

Latching data from the input register to the DPS register under standard operation of the MAX32010 requires an additional command, and/or use of $\overline{\text{LOAD}}$. An alternative “shortcut” is to take $\overline{\text{CS}}$ low, satisfy the minimum $\overline{\text{CS}}$ low pulse-width specification, and then return it high without any coincident clock activity. Data in the input register is latched to the DPS register on the rising edge of $\overline{\text{CS}}$.

Programmable Analog Modes Current-Range Selection

Bits D11 to D13 of the control word (RS0, RS1, and RS2) control the full-scale current range for either FI (force current) or MI (measure current) mode.

Current monitor resistor values and current ranges are listed in **Table 3**.

Table 3. Range Select Bits and Nominal Sense Resistor Values

DATA BITS			RANGE	MAXIMUM CURRENT	NOMINAL SENSE RESISTOR VALUE (Ω)
RS2 (D13)	RS1 (D12)	RS0 (D11)			
0	0	0	D	$\pm 200\mu\text{A}$	5000
0	0	1	C	$\pm 2\text{mA}$	500
0	1	0	B	$\pm 20\text{mA}$	50
0	1	1	A	$\pm 1200\text{mA}$	0.83
1	X	X	External	—	—

Following formula can be used to calculate the nominal sense resistor value for particular maximum current. Refer to Maxim [Application Note 7068](#) for more details.

$$R_{\text{SENSE}} = 1V/I_{\text{OUT}}$$

V_{IN} and Measurement Voltage, Variable-Gain Amplifier Selection

Bits D14 to D16 of the control word (G0, G1, and G2) control the gain and polarity of the variable-gain amplifiers (VGAs). These bits also control the gain of the measurement amplifier, allowing a 1:1 input-to-output voltage transfer function when in the FVMV mode. The settings are detailed in **Table 4**.

Table 4. VGA Gain and Polarity Select Bits

DATA BITS*			V _{IN} VGA	MEASUREMENT VOLTAGE VGA
G2 (D16)	G1 (D15)	G0 (D14)		
0	0	0	+1	+1
0	0	1	+2	+1/2
0	1	0	+6	+1/6
1	0	0	-1	+1
1	0	1	-2	+1/2
1	1	0	-6	+1/6

*States 011 and 111 are unused.

Mode Selection

Bits D8 and D17 in the control word ($\overline{\text{HIZFRC}}$ and FMODE) select the mode of operation of the MAX32010, indicated in **Table 5**. FMODE selects whether the DPS forces a voltage or a current. $\overline{\text{HIZFRC}}$ determines if the driver amplifier is placed in a high-output-impedance state, or if V_{INS} is selected as the input to the amplifier (FI slave mode).

Table 5. DPS Mode-Select Bits

DATA BITS		DPS MODE	AMP INPUT	OUTPUTS RA, RB, RC, AND RD
HIZFRC (D8)	FMODE (D17)			
0	0	High Impedance	AGND	High Impedance
0	1	FI Slave	V _{INS}	Current
1	0	FV	V _{IN}	Voltage
1	1	FI	V _{IN}	Current

*States 011 and 111 are unused.

In FV and FI modes, IMEAS and V_{MEAS} outputs provide measurement of the DUT sense voltage or current, allowing flexible modes of operation beyond the traditional force-voltage/measure-current (FVMI) and force-current/measure-voltage (FIMV) modes. The modes supported are:

FVMI: Force-voltage/measure-current

FIMV: Force-current/measure-voltage

FVMV: Force-voltage/measure-voltage

FIMI: Force-current/measure-current

FNMV: Force-nothing/measure-voltage

In the FV or FI modes, V_{IN} is selected to control the forced voltage or forced current. In the FI slave mode, V_{INS} is selected. This allows connecting a master DPS to its slaves without using external relays.

Digital Interface Operation

A 3-wire SPI/QSPI™/MICROWIRE-compatible serial interface is used for command and control of the MAX32010. The serial interface operates with clock speeds up to 20MHz. Additionally, a few logic inputs control special functions, sometimes working with the serial interface control data, sometimes overriding it.

Logic Inputs and Shared Control Functions

Control of the measurement output high-impedance state is shared between the \overline{HIZMS} bit (D7) and the logic input \overline{HIZMP} . Data transfer operations from the input shift register to the two internal control registers, input and DPS, are shared between the control word's A0 and C0 bits, and logic input \overline{LOAD} (see the *Configuration and Control* section).

Digital Inputs

Digital inputs \overline{SCLK} , \overline{DIN} , \overline{CS} , \overline{LOAD} , \overline{HIZMP} , and $\overline{IDDQSEL}$ incorporate hysteresis to mitigate noise and to provide compatibility with opto-isolators. Voltage threshold levels for digital inputs are determined by V_{THR} and default to $1/2 V_L$ if V_{THR} is left unconnected.

Digital Output (DOUT)

When the input data register is full, the data become available at DOUT in a first-in, first-out (FIFO) fashion, allowing multiple devices to be daisy-chained. Data at DOUT follows \overline{DIN} with a delay of 18 clock cycles per chained unit. The digital output is clocked on the falling edge of the input clock, allowing daisy-chained devices to use the same clock signal.

Serial-Port Timing

Timing of the serial port is detailed in the *Timing Diagram* and **Figures 3 and 4**, and in the serial port timing characteristics section of the AC *Electrical Characteristics* table.

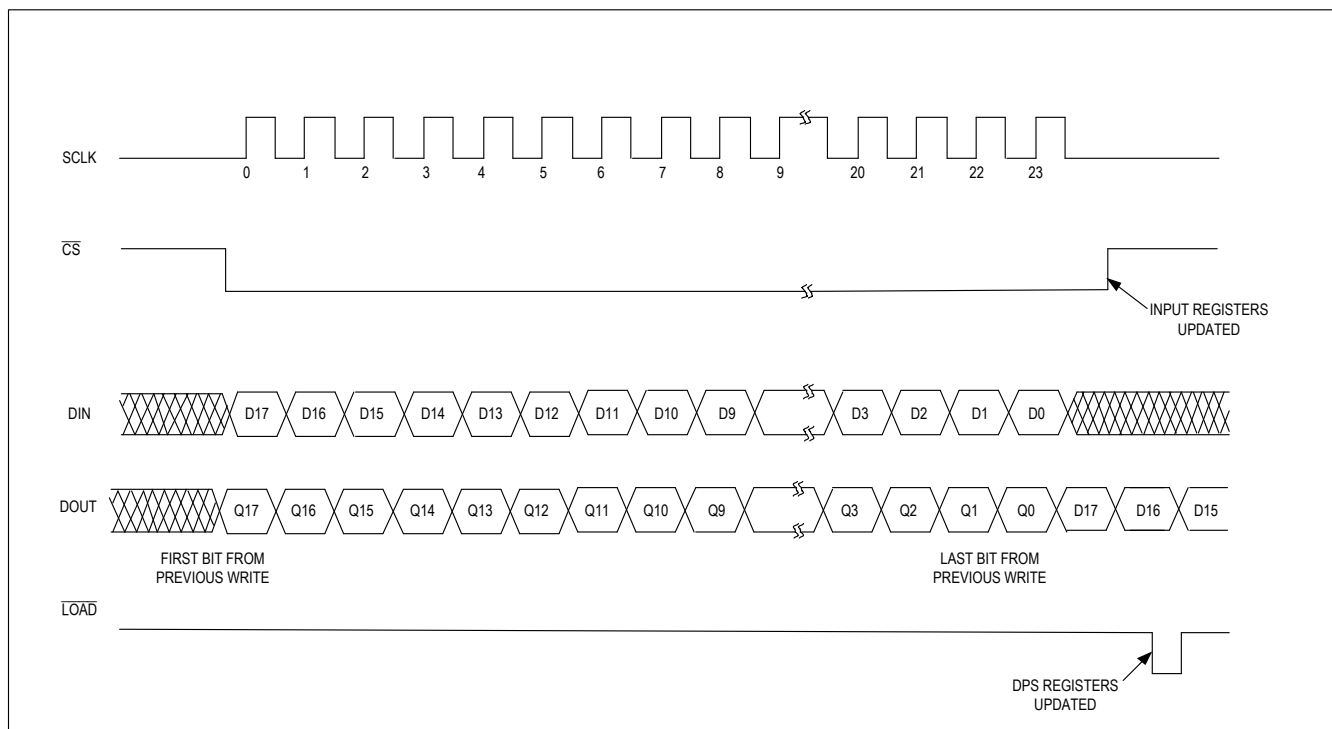

Figure 3. Serial Interface Timing with Asynchronous Loading of the DPS Register

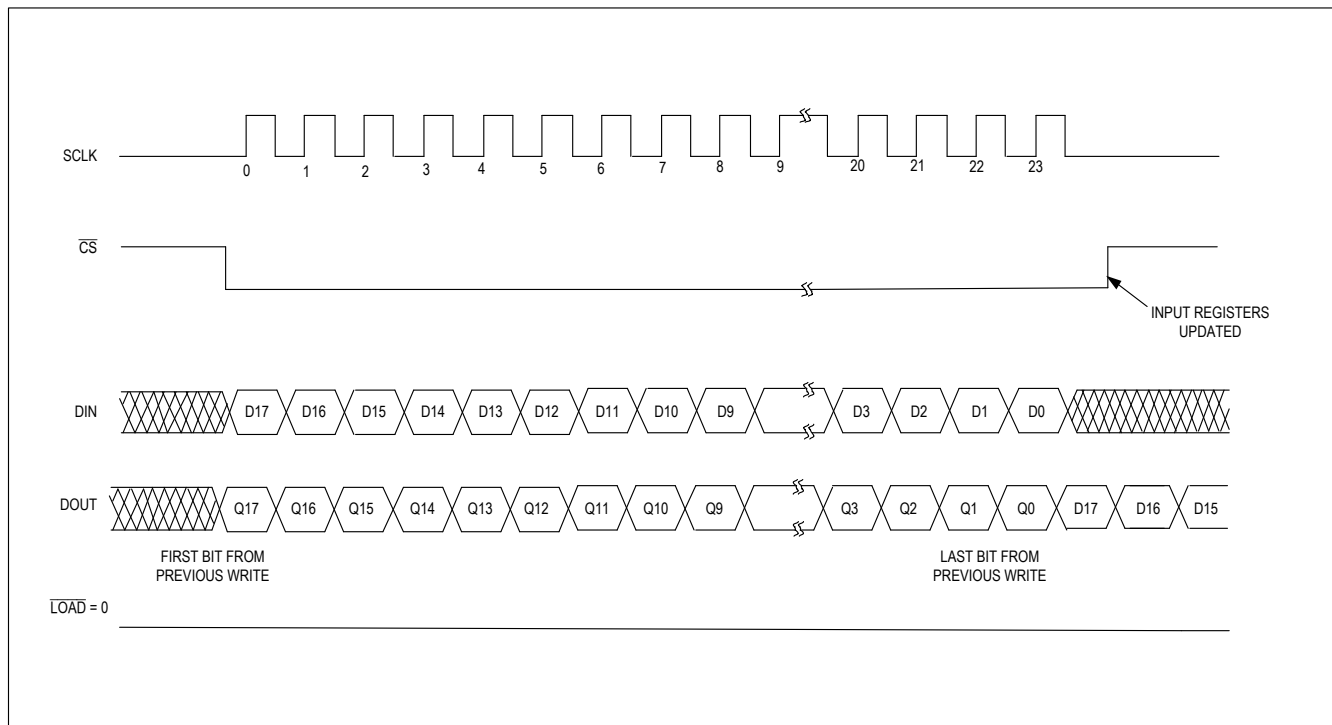

Figure 4. Serial Interface Timing with Synchronous Loading of the DPS Register

Applications Information

Exposed Pad

Leave EP unconnected or connect to V_{EE} . Do not connect EP to ground.

Lead Compensation Capacitor Selection

The MAX32010 can drive widely varying load capacitances. As the load capacitance increases, the output of the DPS tends to overshoot. To counter this, lead compensation capacitor network connections are provided, each with dedicated internal switches controllable through the serial interface (as seen in the *Functional Diagram*). The networks can be tailored to specific needs, such as settling time vs. overshoot, with combinations of capacitors. Control bits D5 and D4 (LCOMP1 and LCOMP0) configure compensation capacitor connections as shown in **Table 6**.

Table 6. Lead Compensation Capacitor Selection

DATA BITS		COMPENSATION CAPACITOR SELECT	MINIMUM CAPACITOR VALUE (pF)	MAXIMUM CAPACITOR VALUE (pF)
LCOMP1 (D5)	LCOMP0 (D4)			
0	0	None	—	—
0	1	CCOMP1	27	330
1	0	CCOMP2	27	330
1	1	CCOMP1 and CCOMP2	27 each	330 each

Bypass Compensation Capacitor Selection

In addition to lead compensation, the DPS also implements bypass compensation, which may be required under conditions of heavy capacitive loading. Depending on the mode selected, FV or FI, control bits D3 and D2 (BCOMP1 and BCOMP0) select different capacitors. In the FV mode, one of three bypass capacitors (CB1, CB2, and CB3), or none is

selected, as shown in **Table 7**. **Table 8** presents the recommended CB1, CB2, and CB3 capacitor values for various load conditions.

In FI mode, the bypass capacitor combination (CCH/CCL), or none, is selected (**Table 9**). **Table 10** presents the recommended CCH and CCL capacitor values for various load conditions. These compensation capacitors provide improved stability for the voltage clamp circuit when driving heavy loads.

Table 7. FV Mode Bypass Capacitor Selection

DATA BITS		BYPASS CAPACITOR SELECT
BCOMP1 (D3)	BCOMP0 (D2)	
0	0	None
0	1	CB1
1	0	CB2
1	1	CB3

Table 8. CB1, CB2, and CB3 Recommended Values

RANGE	LOAD						
	$\geq 1\text{nF}$	$\geq 10\text{nF}$	$\geq 100\text{nF}$	$\geq 1\mu\text{F}$	$\geq 10\mu\text{F}$	$\geq 100\mu\text{F}$	$\leq 1000\mu\text{F}$
A	—	—	CB1 = 2.7nF	CB1 = 2.7nF	CB2 = 10nF	CB3 = 22nF	CB3 = 22nF
B	—	—	CB1 = 2.7nF	CB1 = 2.7nF	CB2 = 10nF	CB3 = 22nF	—
C	—	CB1 = 2.7nF	CB1 = 2.7nF	CB2 = 10nF	CB3 = 22nF	—	—
D	CB1 = 2.7nF	CB1 = 2.7nF	CB2 = 10nF	CB3 = 22nF	—	—	—

Table 9. FI Mode Voltage Clamp Compensation Capacitor Selection

DATA BITS		FORCE-CURRENT MODE COMPENSATION CAPACITOR SELECT
BCOMP1 (D3)	BCOMP0 (D2)	
0	0	None
X	1	CCL/CCH
1	X	CCL/CCH

X = Don't care.

Table 10. CCH and CCL Recommended Values (CCH = CCL)

RANGE	LOAD							
	$\geq 100\mu\text{F}$	$\geq 1\text{nF}$	$\geq 10\text{nF}$	$\geq 100\text{nF}$	$\geq 1\mu\text{F}$	$\geq 10\mu\text{F}$	$\geq 100\mu\text{F}$	$\leq 1000\mu\text{F}$
A	—	—	—	4.7nF	4.7nF	4.7nF	4.7nF	4.7nF
B	—	—	4.7nF	4.7nF	4.7nF	4.7nF	4.7nF	—
C	—	4.7nF	4.7nF	4.7nF	4.7nF	4.7nF	—	—
D	4.7nF	4.7nF	4.7nF	4.7nF	4.7nF	—	—	—

Measurement Output High-Impedance Control

Place the measurement output into a low-leakage, high-impedance state in either of two ways: with the $\overline{\text{HIZMS}}$ control bit (D7), or the digital input $\overline{\text{HIZMP}}$. The two controls are logically ANDed, as shown in **Table 11**. The digital input $\overline{\text{HIZMP}}$ allows multiplexing between several DPS measurement outputs without using the serial interface.

Table 11. Measurement Output High-Impedance Control

DATA BIT $\overline{\text{HIZMS}}$ (D7)	DIGITAL INPUT $\overline{\text{HIZMP}}$	MEASUREMENT OUTPUT (V_{MEAS} , I_{MEAS}) MODE
1	1	Measurement output enabled

1	0	High impedance
0	1	High impedance
0	0	High impedance

Voltage (Current) Clamp Enable

Control word bit CLEN (D10) enables the output clamps when high and disables the clamps when low, as indicated in **Table 12**. In FV mode, current compliance is active. In FI mode, voltage compliance is active.

Table 12. Clamp-Enable Control

CONTROL BIT CLEN (D10)	CLAMP MODE
1	Clamps enabled
0	Clamps disabled

I_{DDQ} Test Mode

While in FV mode, asserting digital input IDDQSEL switches the DPS to the minimum current range (range D), engaging the I_{DDQ} test mode as shown in **Table 13**. Switching to the minimum current range through external control allows low-current I_{DDQ} measurements without reprogramming the DPS through the serial interface. When IDDQSEL is de-asserted, the current range switches back to its programmed value.

Table 13. I_{DDQ} Test Select

DIGITAL INPUT IDDQSEL	MODE
1	I _{DDQ} test
0	Normal

Power-Up Configuration

At power-up, all analog outputs except TEMP default to high impedance.

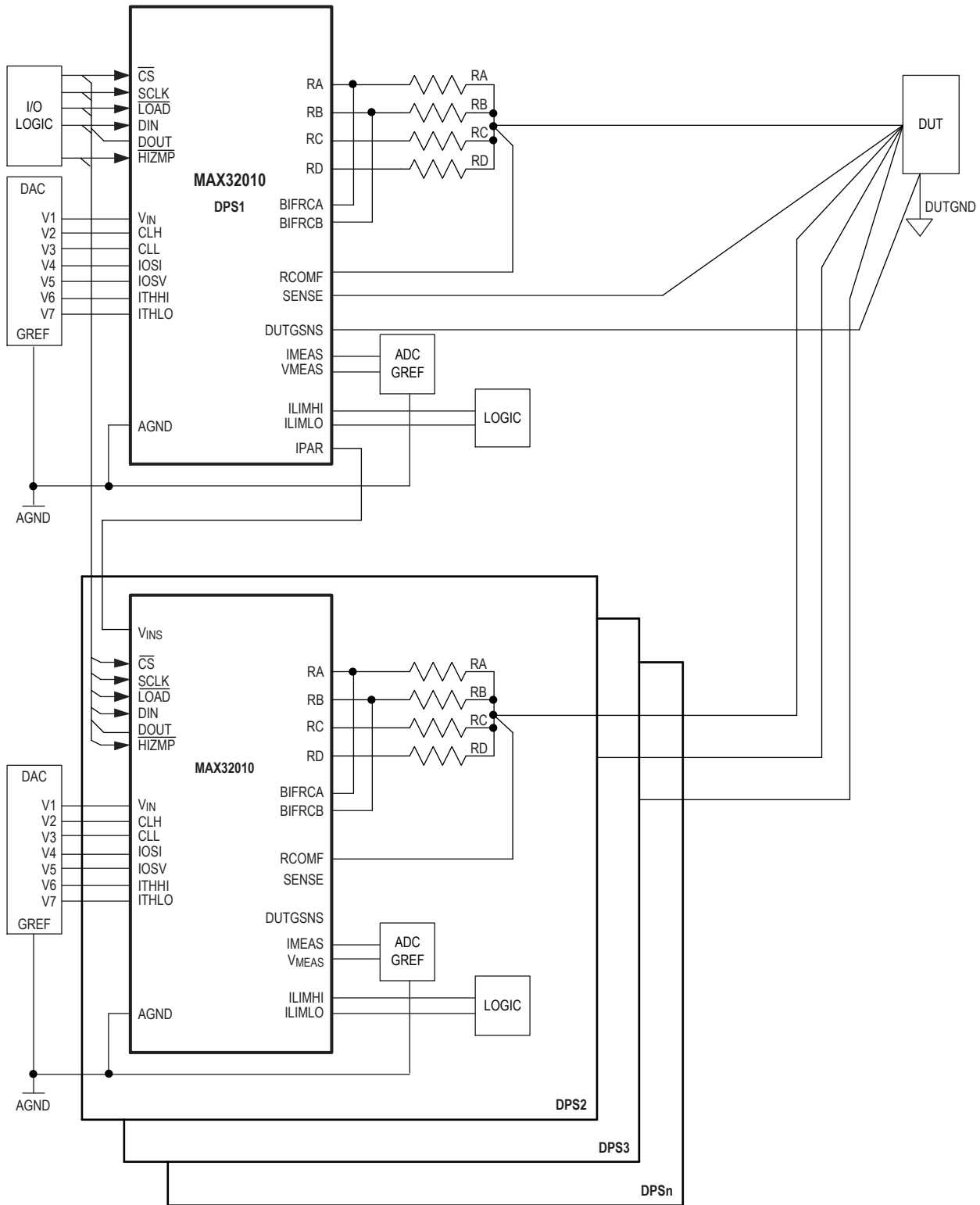

Figure 7. Parallel DPS Configuration Achieves Higher Output Current

Ordering Information

PART NUMBER	TEMP RANGE	PIN-PACKAGE
MAX32010CCQ+	+30°C to +100°C	TQFP-EPR-IDP

Revision History

REVISION NUMBER	REVISION DATE	DESCRIPTION	PAGES CHANGED
0	11/20	Release for intro	—

QSPI is a trademark of Motorola, Inc.

For pricing, delivery, and ordering information, please visit Maxim Integrated's online storefront at <https://www.maximintegrated.com/en/storefront/storefront.html>.

Maxim Integrated cannot assume responsibility for use of any circuitry other than circuitry entirely embodied in a Maxim Integrated product. No circuit patent licenses are implied. Maxim Integrated reserves the right to change the circuitry and specifications without notice at any time. The parametric values (min and max limits) shown in the Electrical Characteristics table are guaranteed. Other parametric values quoted in this data sheet are provided for guidance.