

Specification

Part No.	:	BB-TG.10.0113
Product Name	:	Triton - 4G/3G/2G Terminal Antenna for Cellular Gateways and Routers with Assisted GPS Hinged SMA(M)
Features	:	LTE / GSM / CDMA /GPS/ DCS /PCS / WCDMA / UMTS / HSPA / GPRS / EDGE /IMT 698MHz to 960MHz, 1710MHz to 2690Mhz Dipole Terminal Antenna Hinged SMA(M) Connector Dimensions: Length 168*18*13mm, Ø13mm RoHS Compliant



1. Introduction

The BB-TG.10.0113 Triton dipole Antenna designed primarily for use with 3G and 4G Cellular Gateways and Routers, with assisted GPS. It does not require a ground-plane to connect to. It has a quality robust PC+ABS housing. The antenna has a SMA(M) connector. It can be used straight or hinged 90 degrees. The antenna has a wide-band high efficiency response on nearly all 4G/3G/2G frequency bands worldwide, and can also be used for other cellular and wireless applications such as GSM, and 2.4GHz Wi-Fi.

2. Specification

ELECTRICAL

In free space

Frequency (MHz)	703~803	824~894	880~960	1575.42	1710 ~1880	1850 ~1990	1920 ~2170	2305 ~2360	2490 ~2690	3400 ~3600
Efficiency (%)										
straight	41.82	33.71	26.83	26.17	41.01	35.76	39.76		46.48	
bent	48.78	45.62	40.51	26.82	49.05	43.56	47.78		55.37	
Average Gain(dBi)										
straight	-3.80	-4.74	-5.73	-5.82	-3.92	-4.48	-4.03		-3.44	
bent	-3.12	-3.41	-3.93	-5.71	-3.14	-3.62	-3.22		-2.63	
Peak Gain(dBi)										
straight	0.34	0.03	-0.48	-1.85	0.67	-0.07	0.23		2.04	
bent	-0.21	0.35	0.22	-2.00	1.00	0.65	1.30		3.45	

With 15cm X 9cm ground

Frequency (MHz)	703~803	824~894	880~960	1575.42	1710 ~1880	1850 ~1990	1920 ~2170	2305 ~2360	2490 ~2690	3400 ~3600
Efficiency (%)										
straight	71.68	49.29	43.13	20.87	57.84	67.45	74.31		66.25	
bent	74.12	61.90	51.94	23.16	53.64	67.19	73.14		68.20	
Average Gain(dBi)										
straight	-1.45	-3.08	-3.66	-6.80	-2.38	-1.74	-1.30		-1.84	
bent	-1.30	-2.09	-2.86	-6.35	-2.71	-1.76	-1.36		-1.70	
Peak Gain(dBi)										
straight	2.85	1.20	0.19	-2.47	2.34	3.57	4.22		3.95	
bent	1.43	0.79	-0.13	-1.44	2.08	2.69	2.96		4.44	

On 30cmX30cm ground plane edge

Frequency (MHz)	703~803	824~894	880~960	1575.42	1710 ~1880	1850 ~1990	1920 ~2170	2305 ~2360	2490 ~2690	3400 ~3600
Efficiency (%)										
straight	57.56	41.53	42.09	18.06	75.91	71.83	68.52		57.08	
bent	57.30	48.37	42.12	20.37	72.62	71.93	70.21		58.98	
Average Gain(dBi)										
straight	-2.41	-3.82	-3.76	-7.43	-1.20	-1.44	-1.65		-2.50	
bent	-2.42	-3.19	-3.76	-6.90	-1.39	-1.43	-1.54		-2.36	
Peak Gain(dBi)										
straight	2.96	0.68	-0.01	-3.02	3.37	2.83	2.82		3.17	
bent	0.61	-0.78	-0.87	-2.61	3.49	4.63	4.76		3.12	

On 30cmX30cm ground plane center										
Frequency (MHz)	703~803	824~894	880~960	1575.42	1710 ~1880	1850 ~1990	1920 ~2170	2305 ~2360	2490 ~2690	3400 ~3600
Efficiency (%)										
straight	42.15	28.00	20.35	24.88	39.11	49.92	55.35		47.74	
bent	27.52	21.92	15.49	24.23	61.22	64.56	62.92		56.43	
Average Gain(dBi)										
straight	-3.76	-5.65	-6.92	-6.04	-4.09	-3.04	-2.58		-3.33	
bent	-5.63	-6.67	-8.12	-6.15	-2.14	-1.90	-2.02		-2.52	
Peak Gain(dBi)										
straight	-0.06	-0.66	-1.81	-2.50	0.98	2.01	2.33		2.07	
bent	-0.31	-2.93	-4.79	1.22	4.11	5.42	4.94		4.70	
Impedance			50Ω							
Polarization			Linear							
Radiation Pattern			Omni							
Input power			5 W							
MECHANICAL										
Dimensions		Length 168*18*13mm,Φ13mm								
Casing		PC+ABS								
Connector		Hinged SMA Male								
Weight		24g								
Recommended Torque for Mounting		0.9 N·m								
Max Torque for Mounting		1.176 N·m								
ENVIRONMENTAL										
Temperature Range		-40°C to 85°C								
Humidity		Non-condensing 65°C 95% RH								

*All the bent testing are at 90 degrees bent.

LTE BANDS			
Band Number	LTE / LTE-Advanced / WCDMA / HSPA / HSPA+ / TD-SCDMA		
	Uplink	Downlink	Covered
1	UL: 1920 to 1980	DL: 2110 to 2170	✓
2	UL: 1850 to 1910	DL: 1930 to 1990	✓
3	UL: 1710 to 1785	DL: 1805 to 1880	✓
4	UL: 1710 to 1755	DL: 2110 to 2155	✓
5	UL: 824 to 849	DL: 869 to 894	✓
7	UL: 2500 to 2570	DL: 2620 to 2690	✓
8	UL: 880 to 915	DL: 925 to 960	✓
9	UL: 1749.9 to 1784.9	DL: 1844.9 to 1879.9	✓
11	UL: 1427.9 to 1447.9	DL: 1475.9 to 1495.9	x
12	UL: 699 to 716	DL: 729 to 746	✓
13	UL: 777 to 787	DL: 746 to 756	✓
14	UL: 788 to 798	DL: 758 to 768	✓
17	UL: 704 to 716	DL: 734 to 746 (LTE only)	✓
18	UL: 815 to 830	DL: 860 to 875 (LTE only)	✓
19	UL: 830 to 845	DL: 875 to 890	✓
20	UL: 832 to 862	DL: 791 to 821	✓
21	UL: 1447.9 to 1462.9	DL: 1495.9 to 1510.9	x
22	UL: 3410 to 3490	DL: 3510 to 3590	x
23	UL: 2000 to 2020	DL: 2180 to 2200 (LTE only)	✓
24	UL: 1625.5 to 1660.5	DL: 1525 to 1559 (LTE only)	x
25	UL: 1850 to 1915	DL: 1930 to 1995	✓
26	UL: 814 to 849	DL: 859 to 894	✓
27	UL: 807 to 824	DL: 852 to 869 (LTE only)	✓
28	UL: 703 to 748	DL: 758 to 803 (LTE only)	✓
29	UL: -	DL: 717 to 728 (LTE only)	✓
30	UL: 2305 to 2315	DL: 2350 to 2360 (LTE only)	✓
31	UL: 452.5 to 457.5	DL: 462.5 to 467.5 (LTE only)	x
32	UL: -	DL: 1452 - 1496	x
35		1850 to 1910	✓
38		2570 to 2620	✓
39		1880 to 1920	✓
40		2300 to 2400	✓
41		2496 to 2690	✓
42		3400 to 3600	x
43		3600 to 3800	x

*Covered bands represent an efficiency greater than 20%

3. Antenna Characteristics

3.1. Testing Setup

In free space



Antenna straight



Antenna bent

On 15 X 9cm ground plane

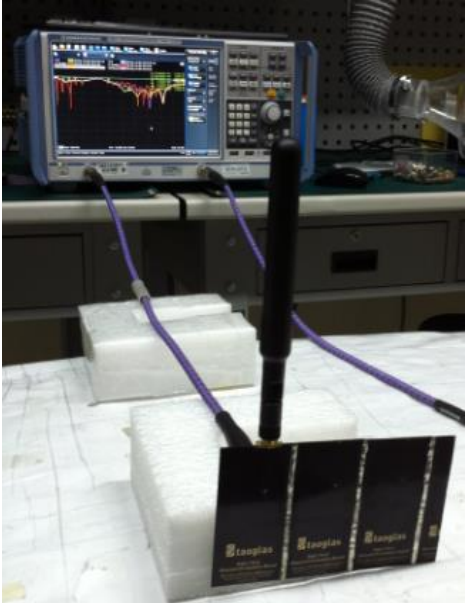

Antenna straight

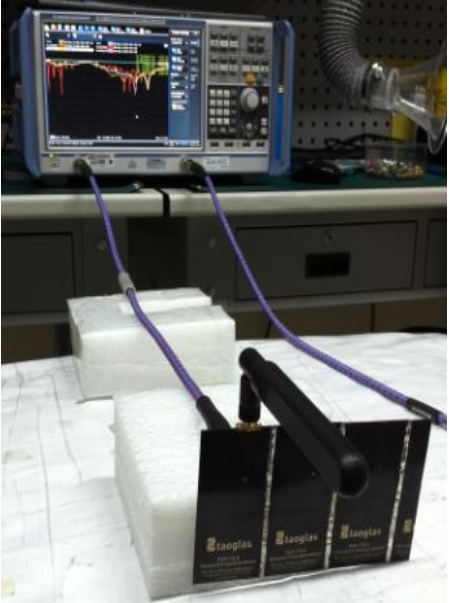

Antenna bent

On 30cm X 30cm ground plane edge



Antenna straight



Antenna bent

On 30cm X 30cm ground plane center



Antenna straight

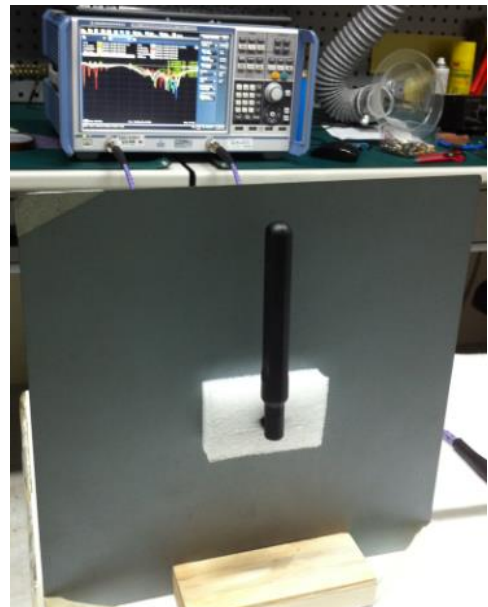

Antenna bent

3.2. Return Loss

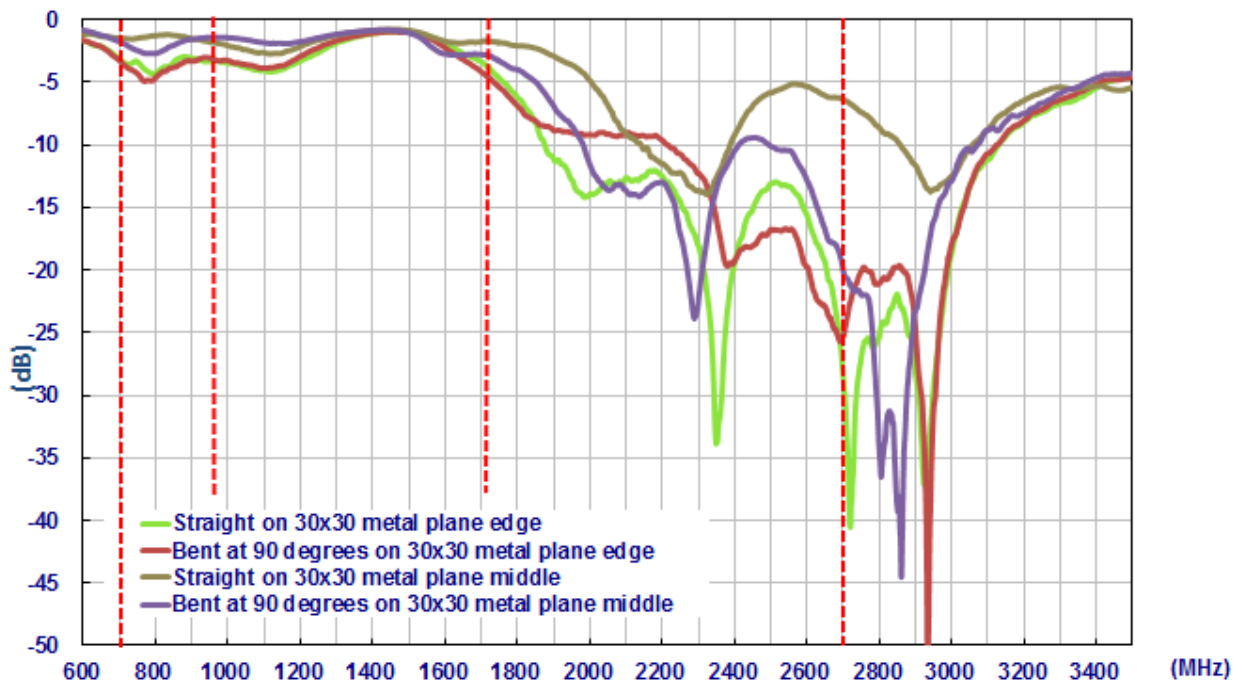
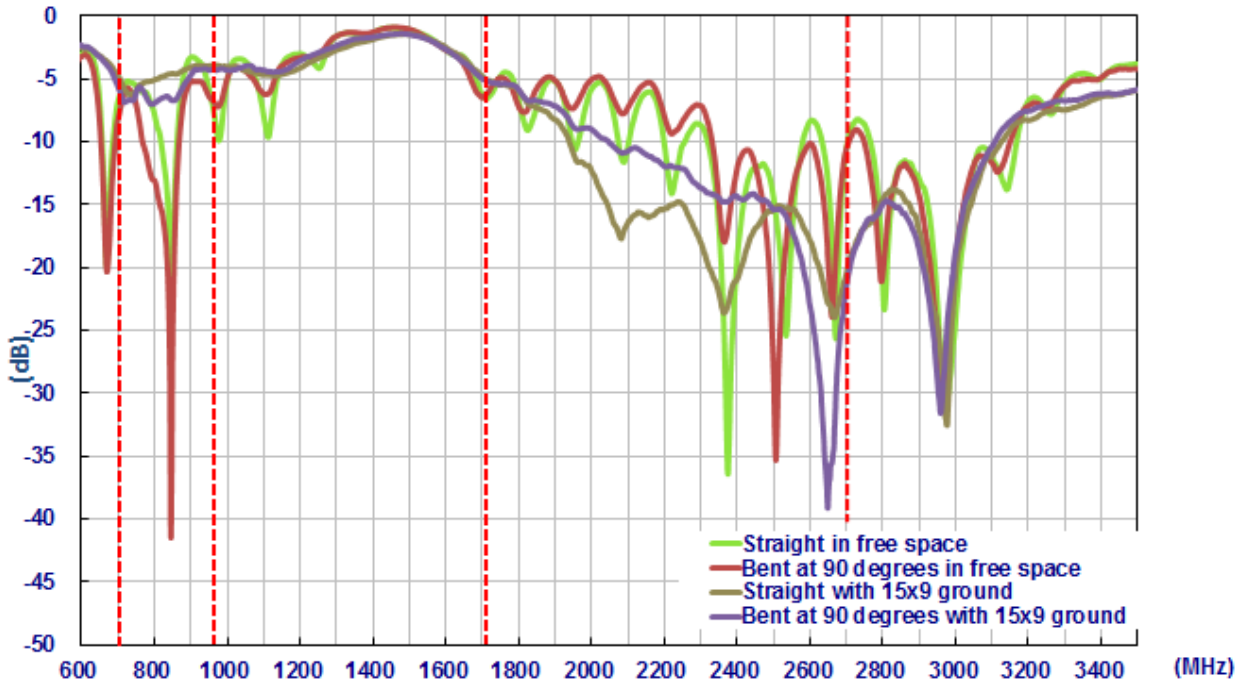

3.3. Peak Gain

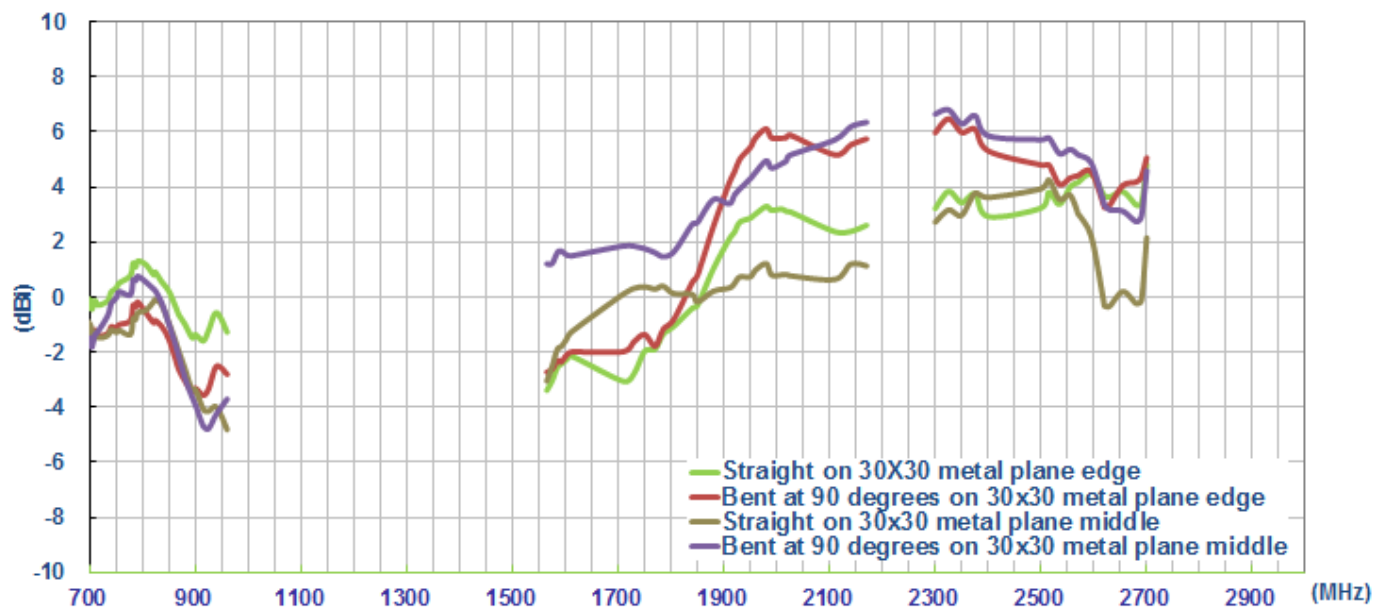
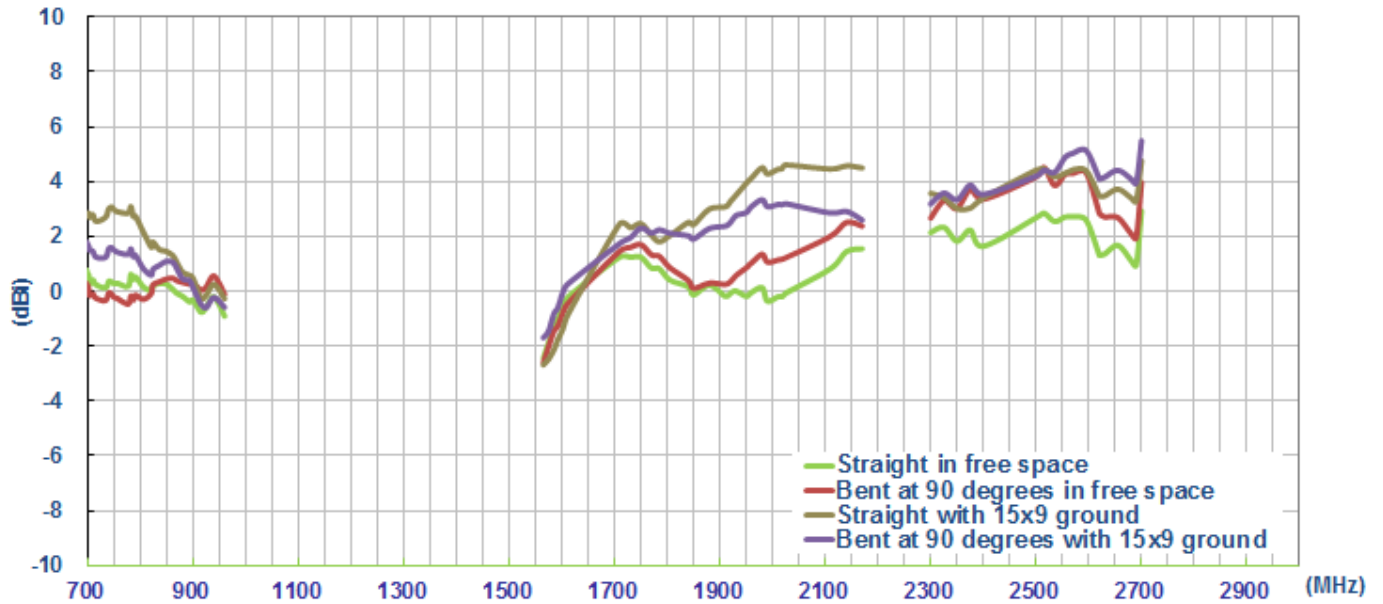

3.4. VSWR

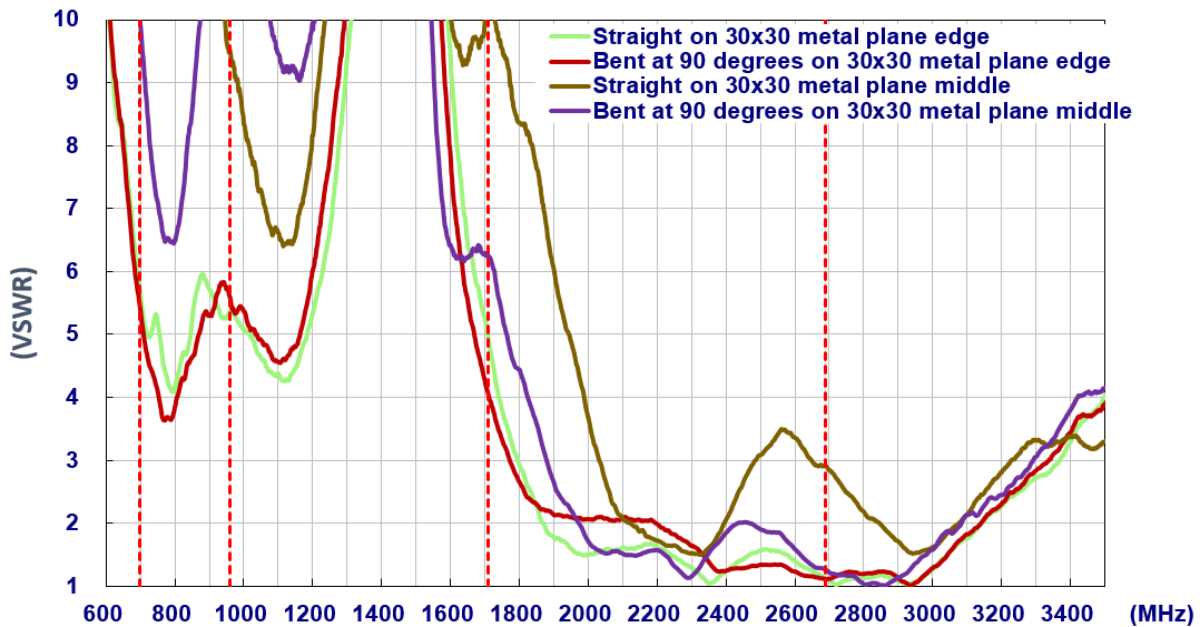
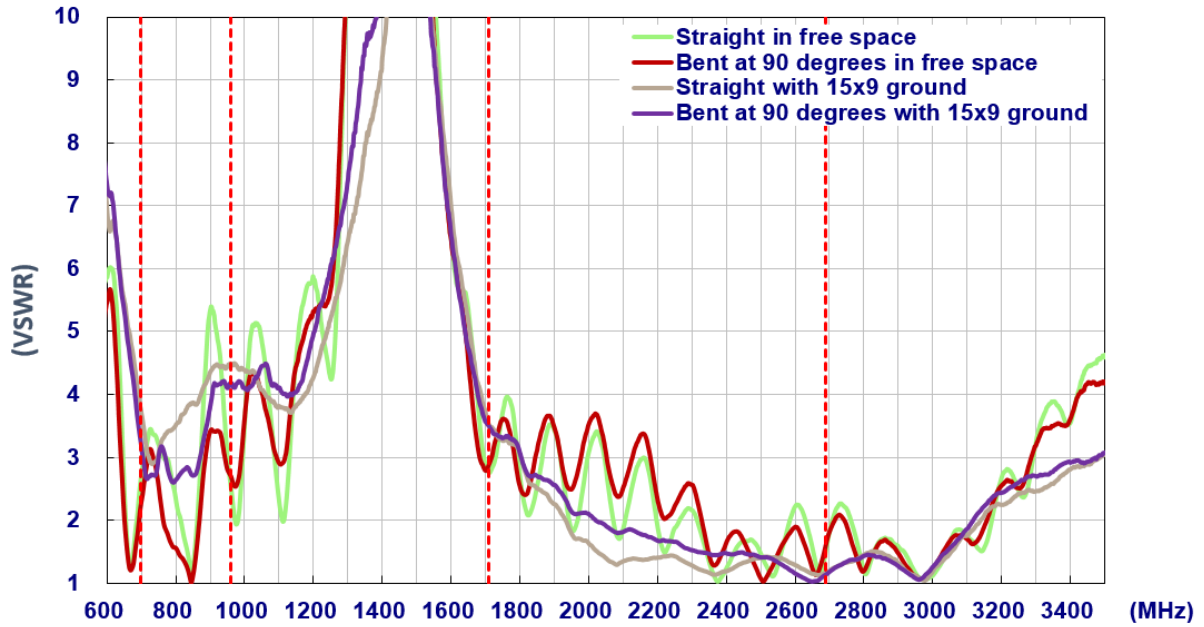

3.5. Efficiency

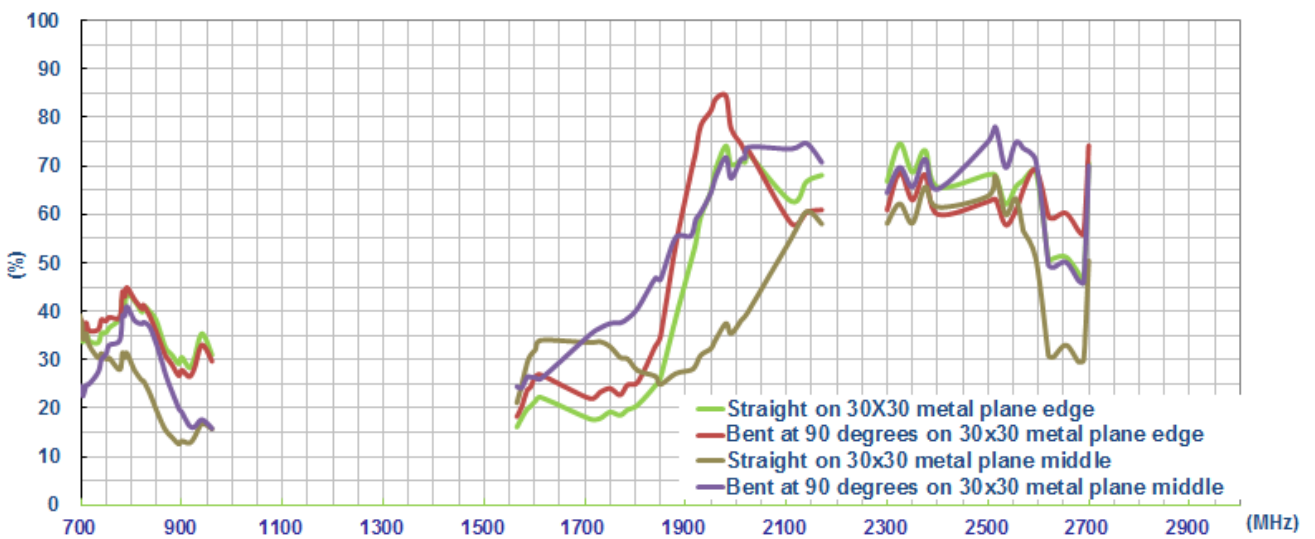
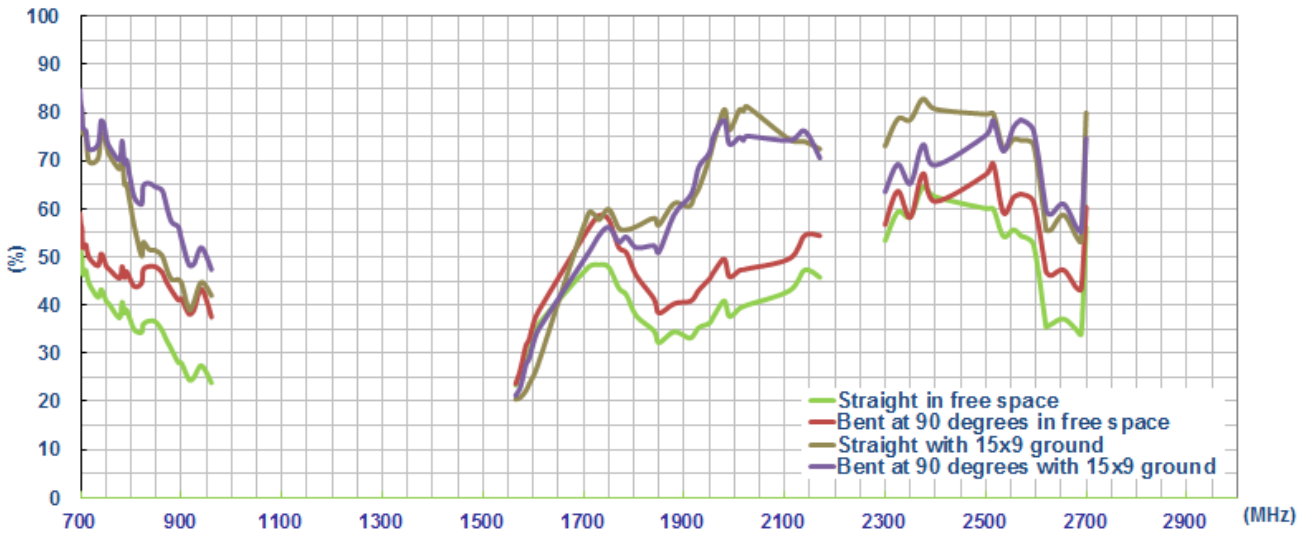

3.6. Average Gain

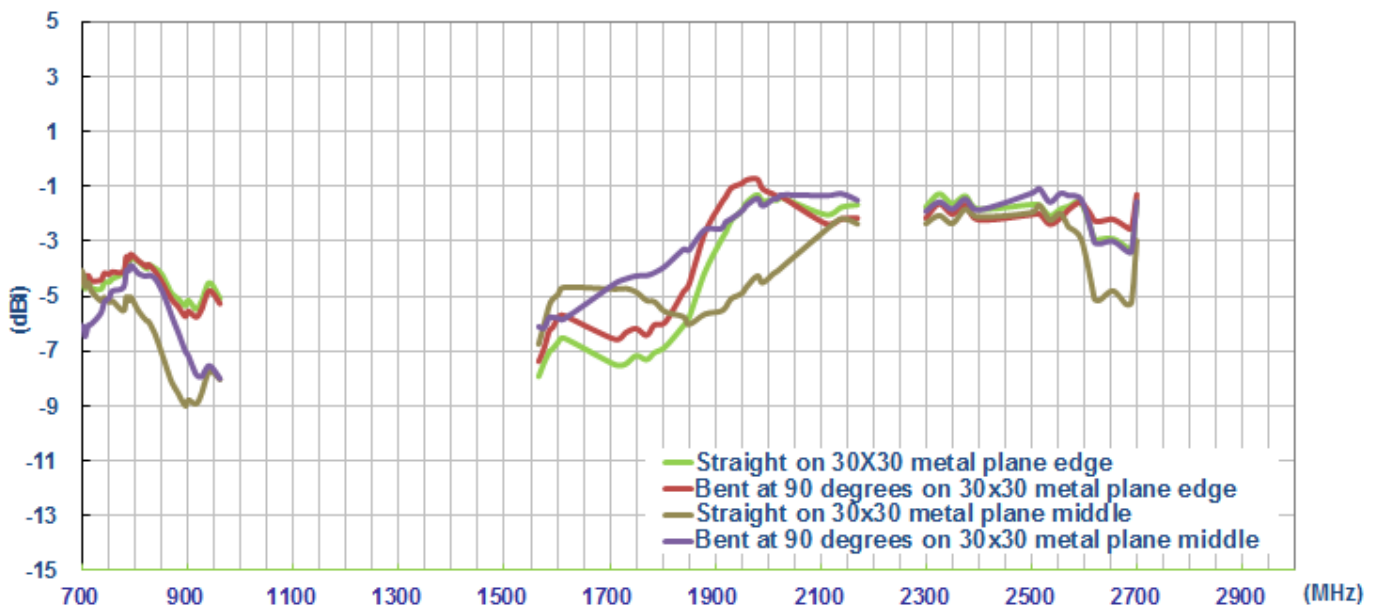
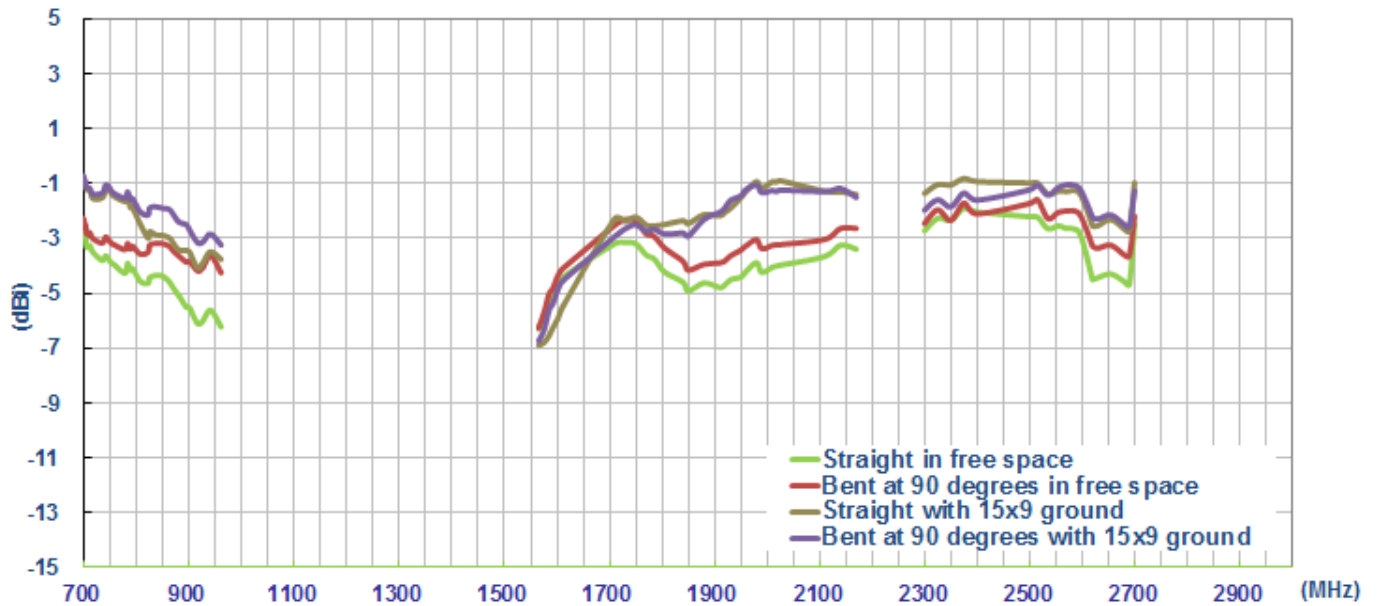

4. Antenna Radiation Patterns

4.1. Antenna Setup – Straight In Free Space

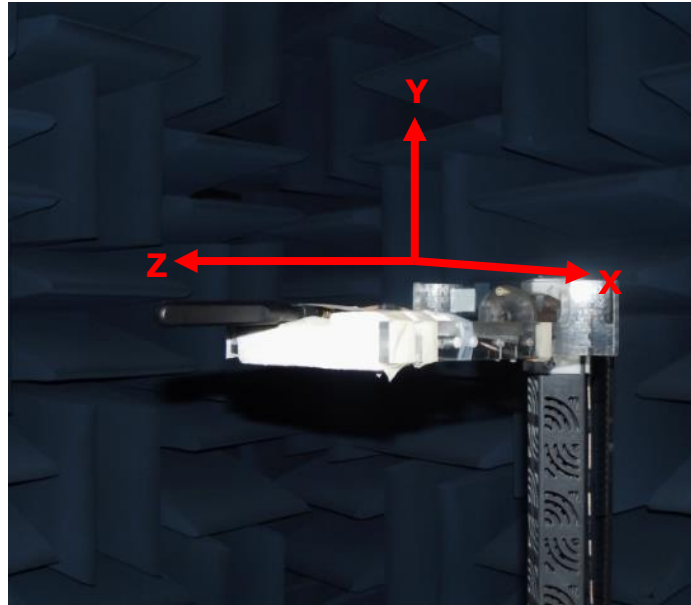

Antenna straight in free space

4.2. Antenna Radiation Patterns

XY Plane

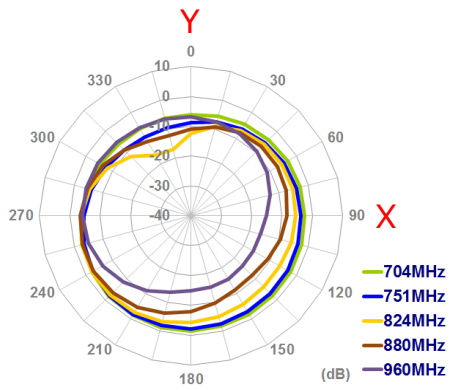

XZ Plane

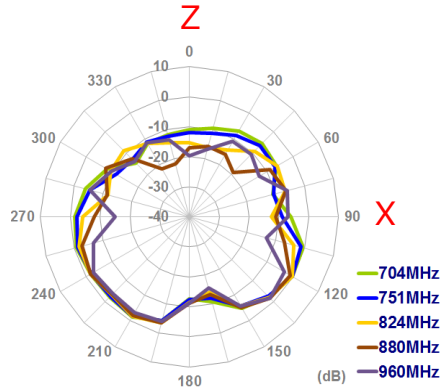

YZ Plane

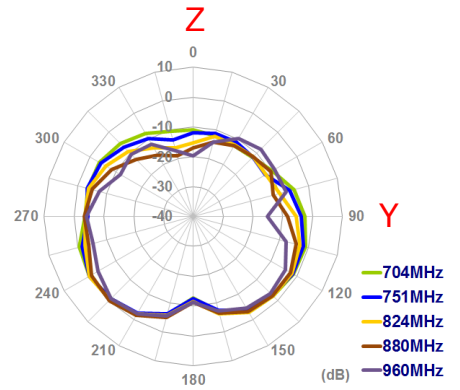

XY Plane

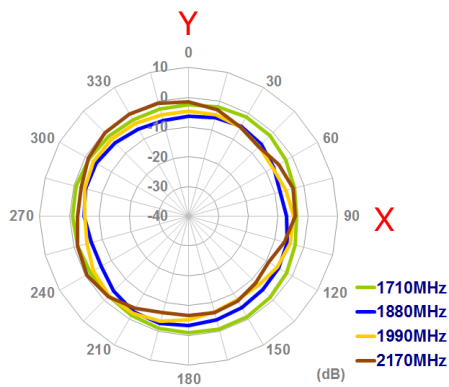

XZ Plane

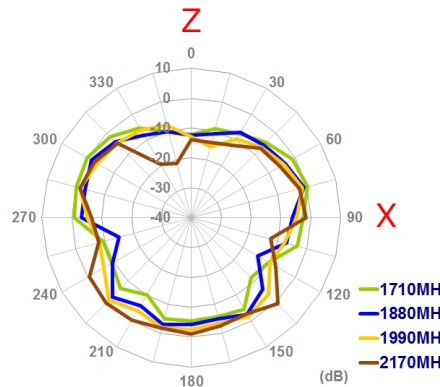

YZ Plane

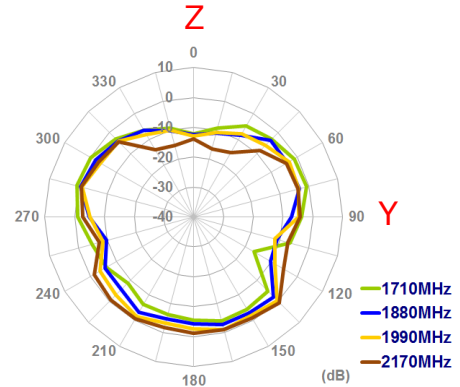

XY Plane

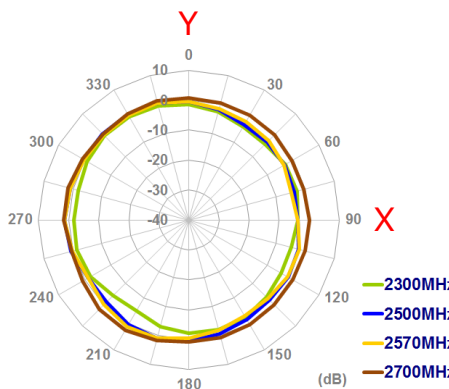

XZ Plane

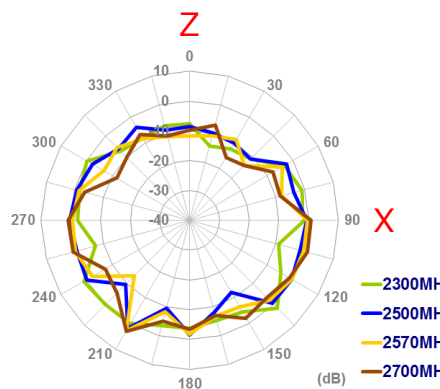

YZ Plane

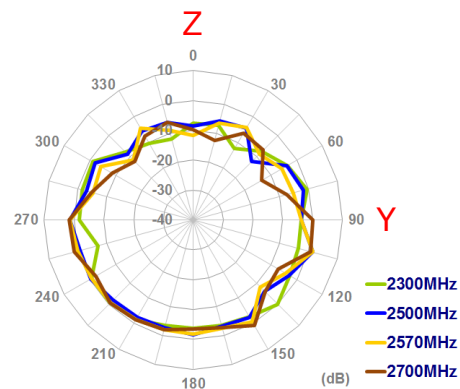

4.3. Antenna Setup – Bent At 90 Degrees In Free Space

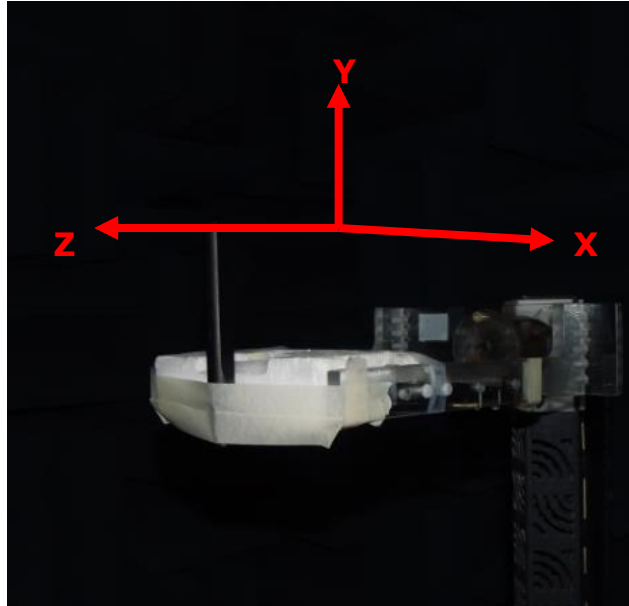

Antenna bent 90 degrees in free space

4.4. Antenna Radiation Patterns

XY Plane

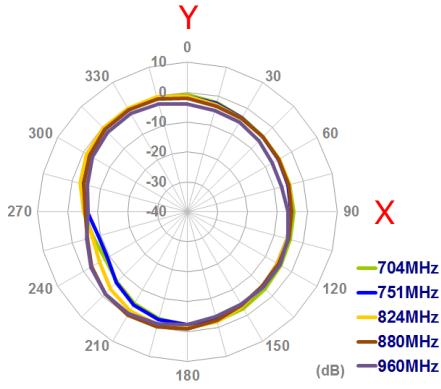

XZ Plane

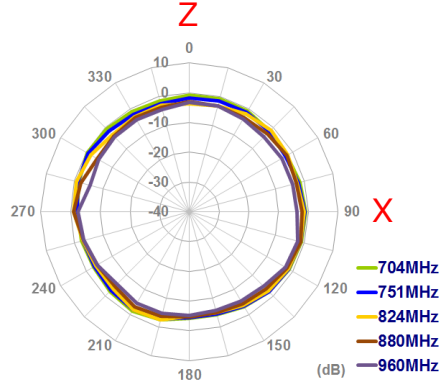

YZ Plane

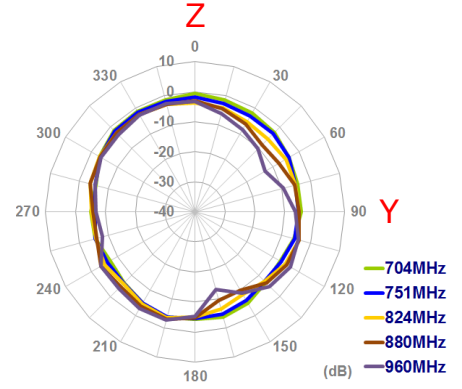

XY Plane

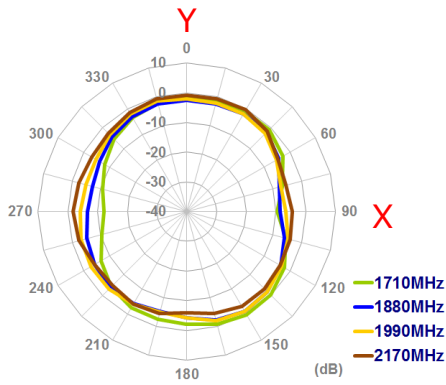

XZ Plane

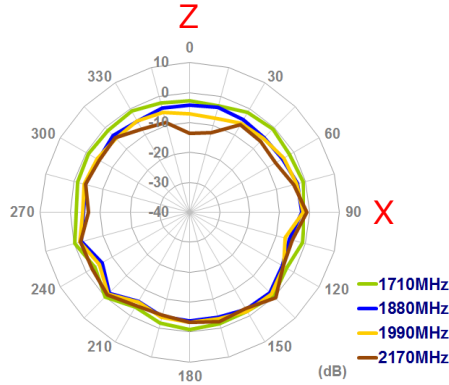

YZ Plane

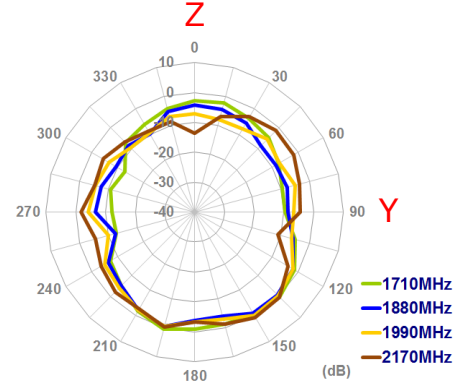

XY Plane

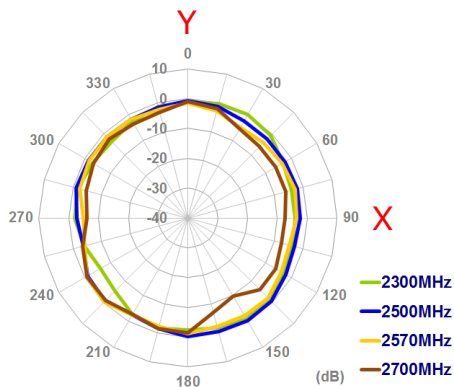

XZ Plane

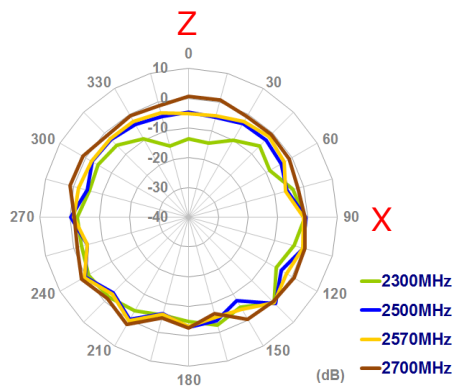

YZ Plane

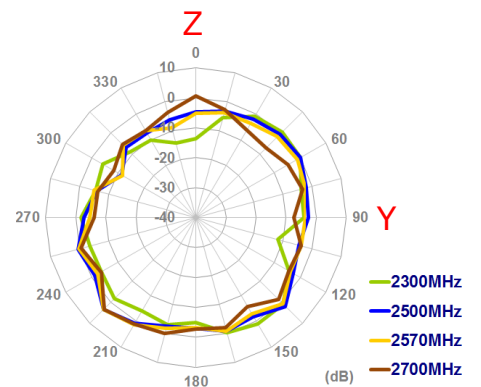

4.5. Antenna Setup – Straight With 15cmX9cm Ground Plane

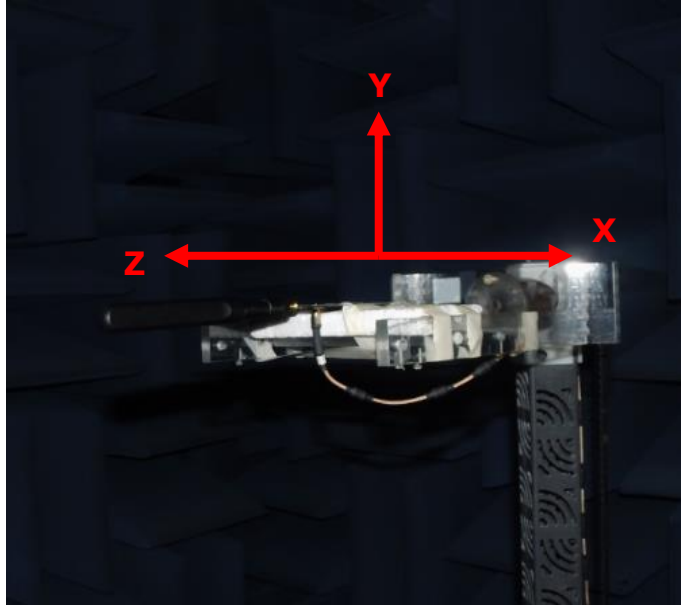

Antenna Straight with 15cm X 9cm ground plane

4.6. Antenna Radiation Patterns

XY Plane

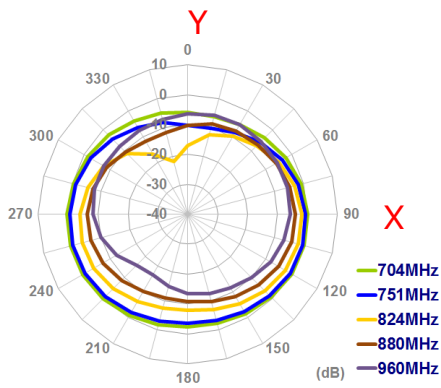

XZ Plane

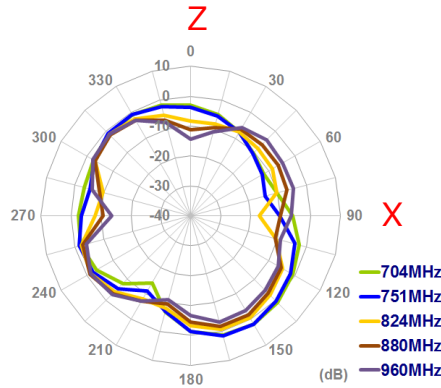

YZ Plane

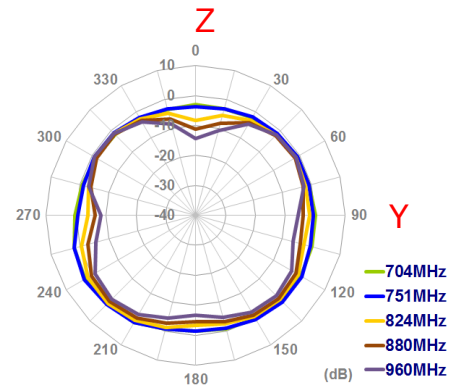

XY Plane

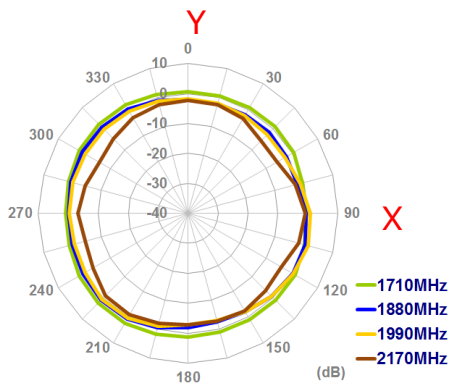

XZ Plane

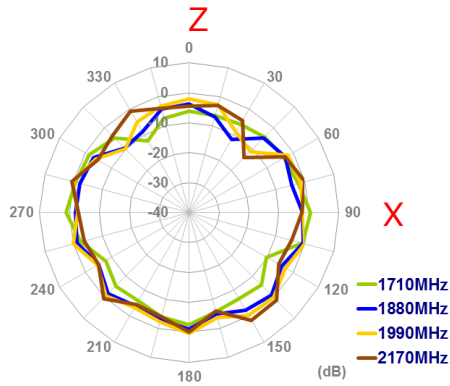

YZ Plane

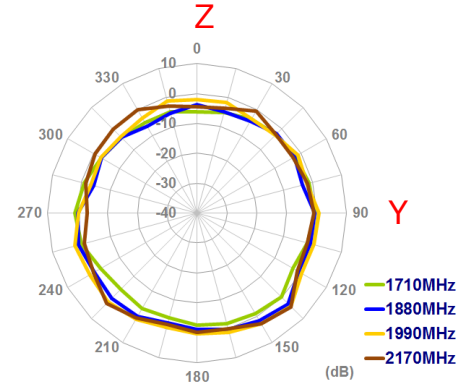

XY Plane

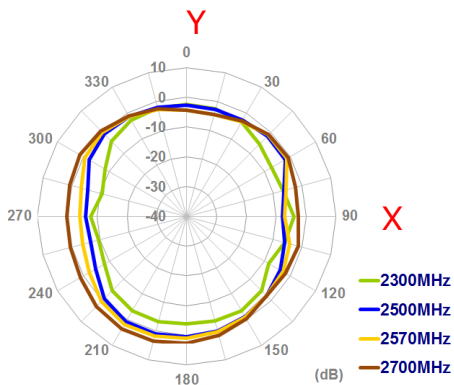

XZ Plane

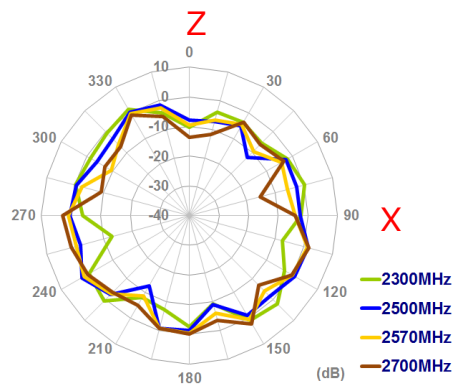

YZ Plane

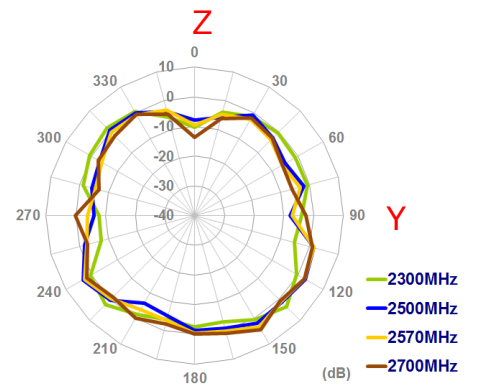

4.7. Antenna Setup – Bent At 90 Degrees With 15cm X 9cm Ground Plane

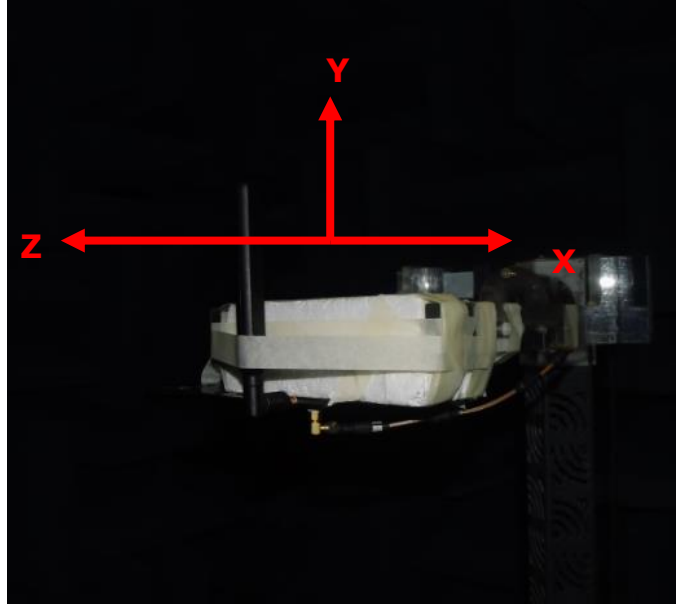

Antenna bent 90 degrees with 15cm X 9cm ground plane

4.8. Antenna Radiation Patterns

XY Plane

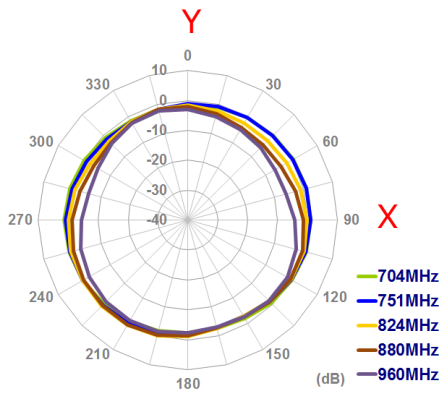

XZ Plane

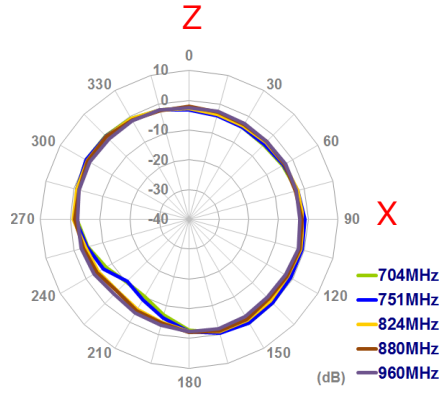

YZ Plane

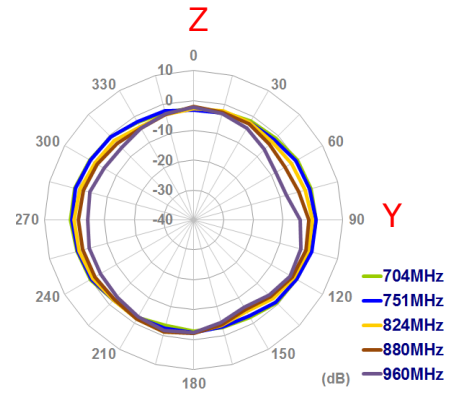

XY Plane

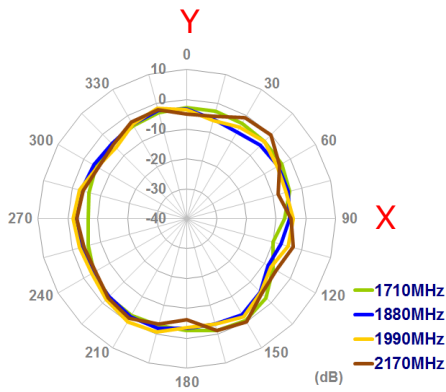

XZ Plane

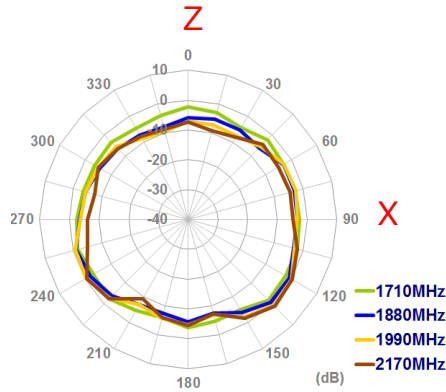

YZ Plane

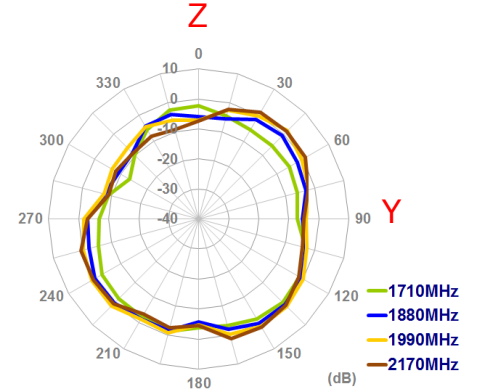

XY Plane

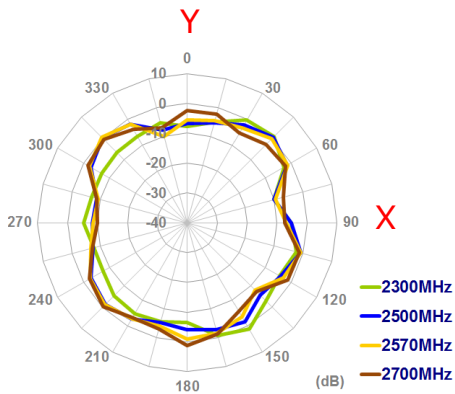

XZ Plane

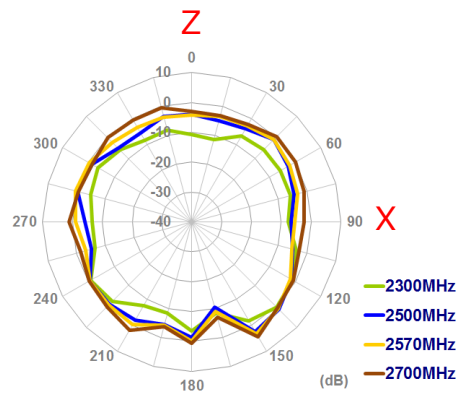

YZ Plane

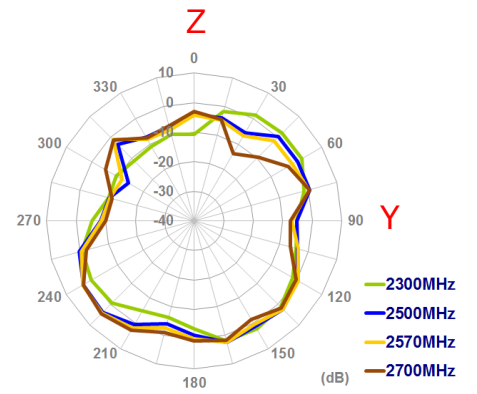

4.9. Antenna Setup – Straight With 30cm X 30cm Ground Plane Edge

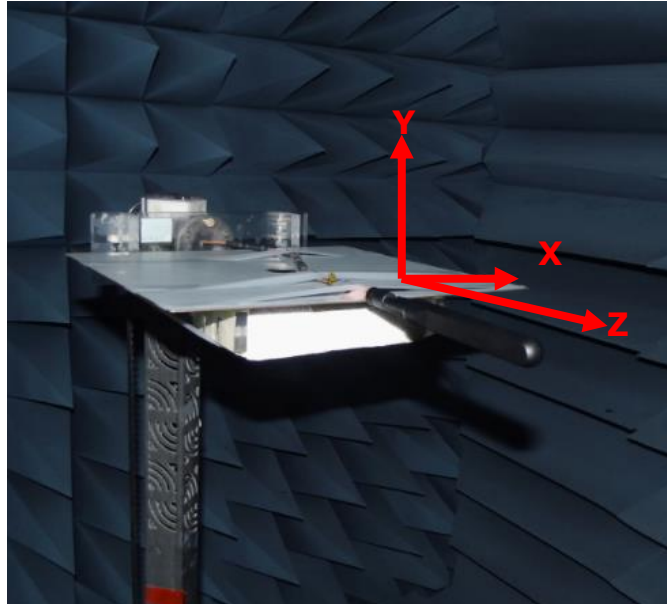

Antenna straight with 30cm X 30cm ground plane edge

4.10. Antenna Radiation Patterns

XY Plane

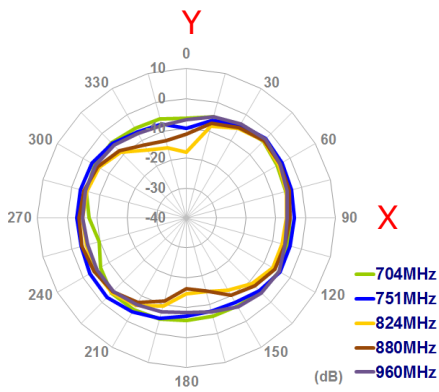

XZ Plane

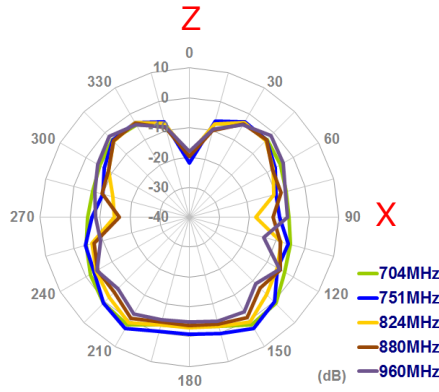

YZ Plane

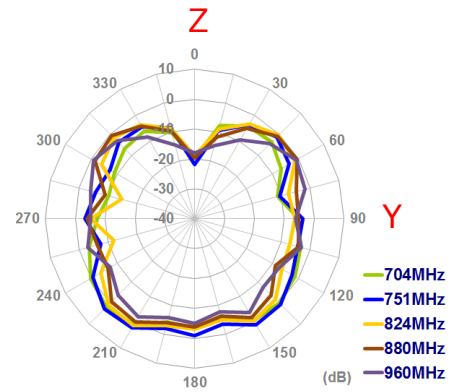

Y

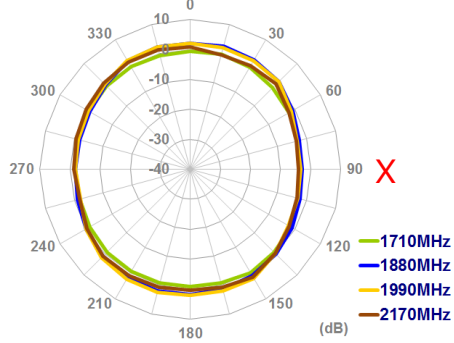

Z

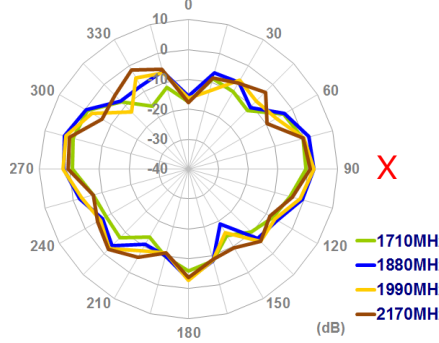

Z

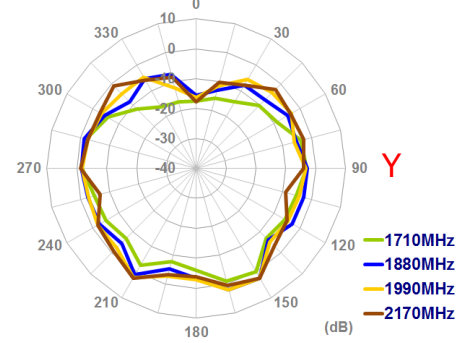

Y

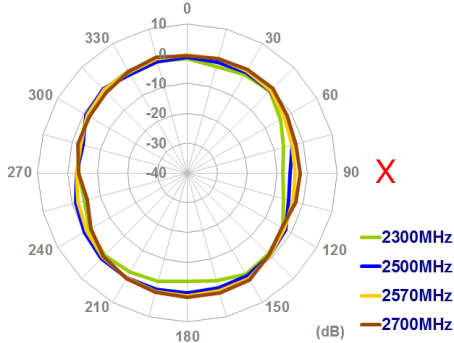

Z

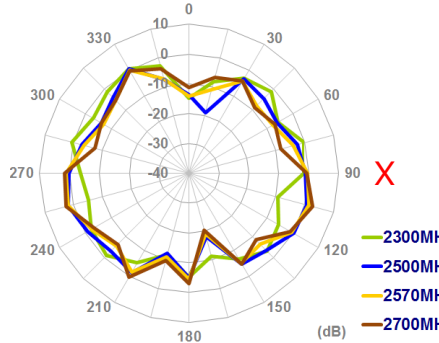

Z

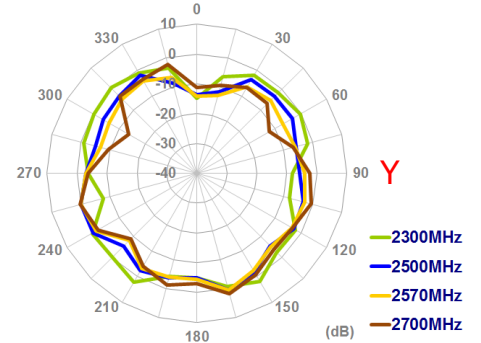

4.11. Antenna Setup – Bent At 90 Degrees With 30 X 30cm Ground Plane Edge

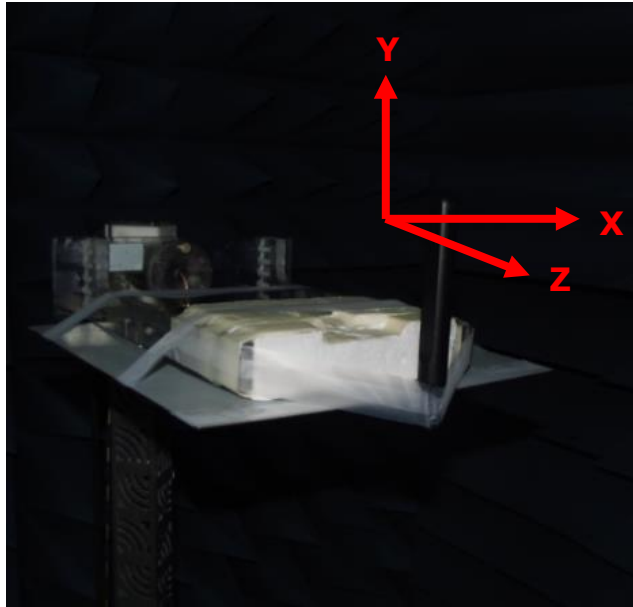

Antenna bent 90 degrees with 30cm X 30cm ground plane edge

4.12. Antenna Radiation Patterns

XY Plane

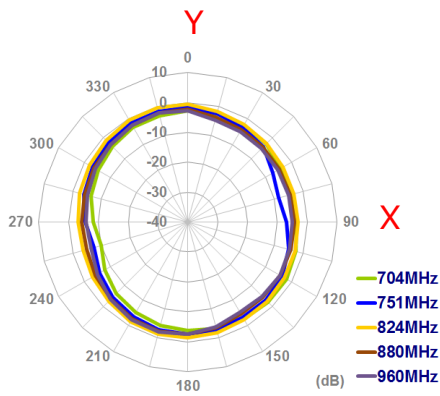

XZ Plane

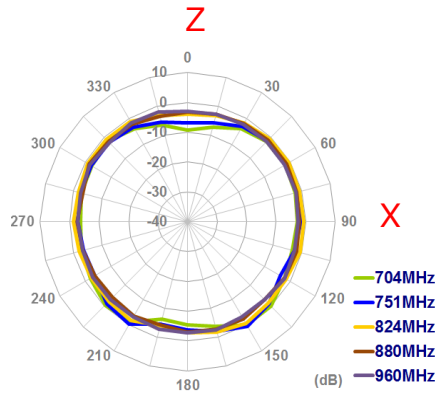

YZ Plane

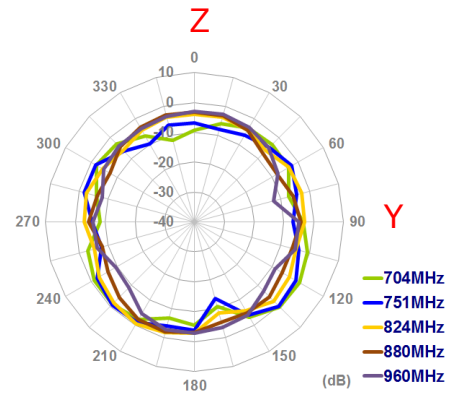

Y

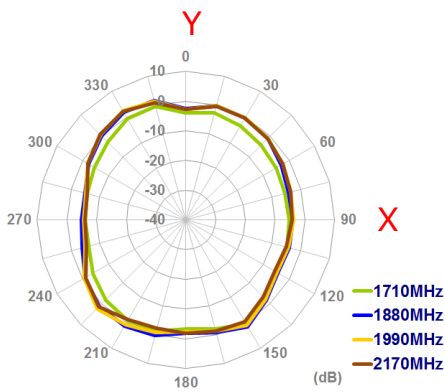

Z

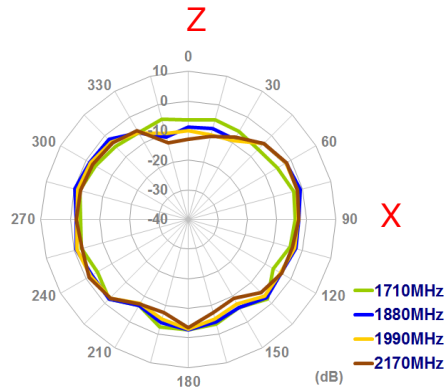

Z

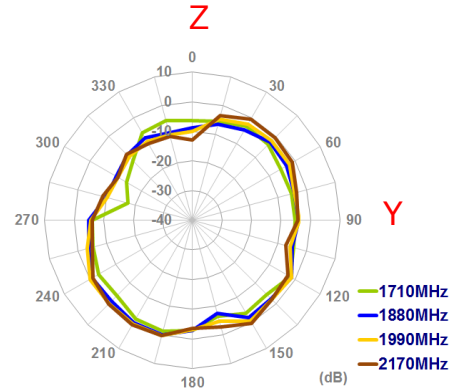

Y

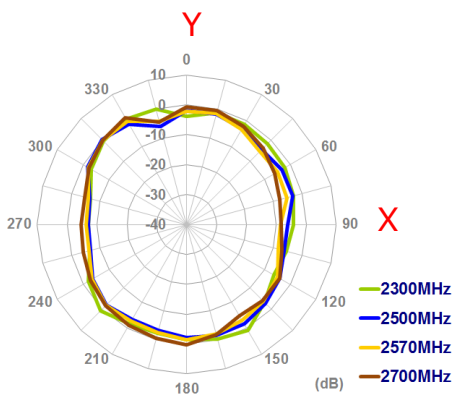

Z

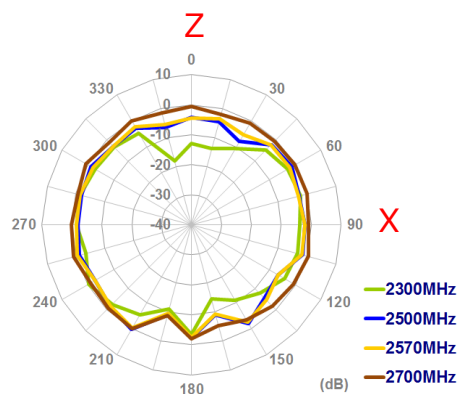

Z

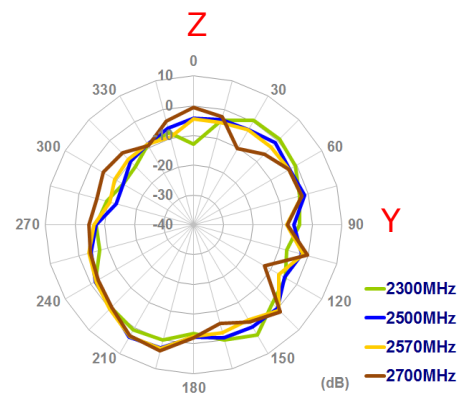

4.13. Antenna Setup – Straight with 30cm X 30cm Ground Plane Center

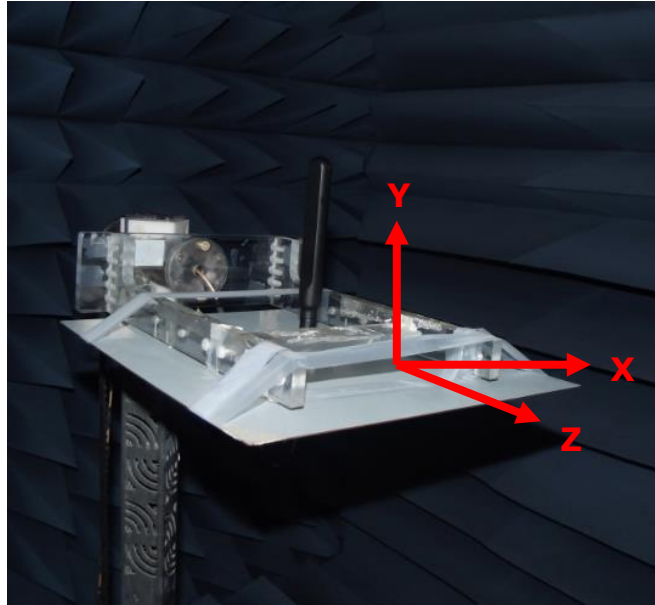

Antenna straight with 30cm x 30cm ground plane center

4.14. Antenna Radiation Patterns

XY Plane

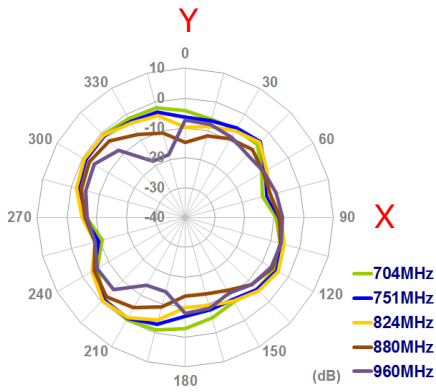

XZ Plane

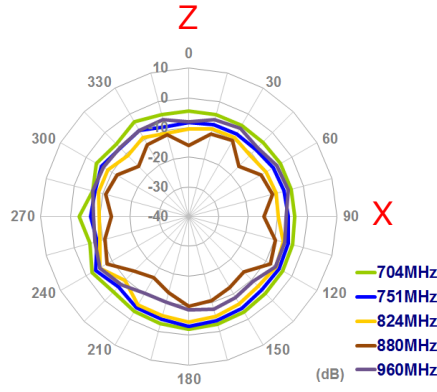

YZ Plane

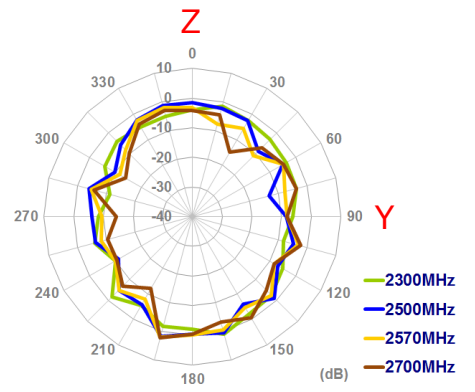
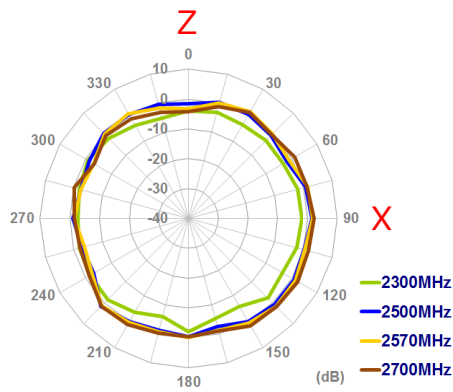
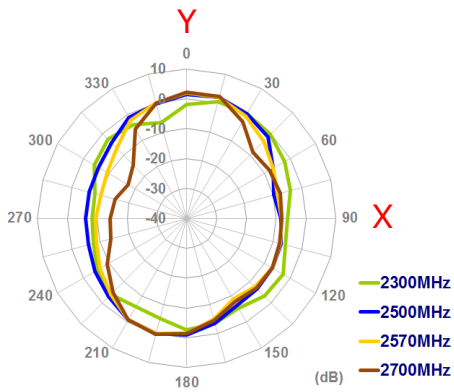
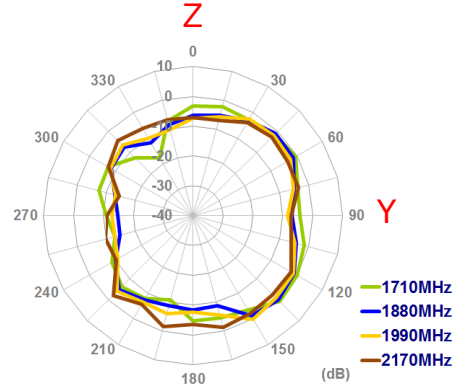
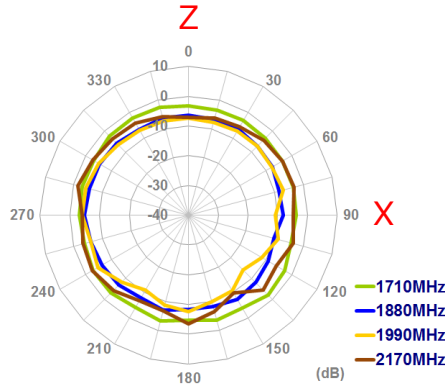
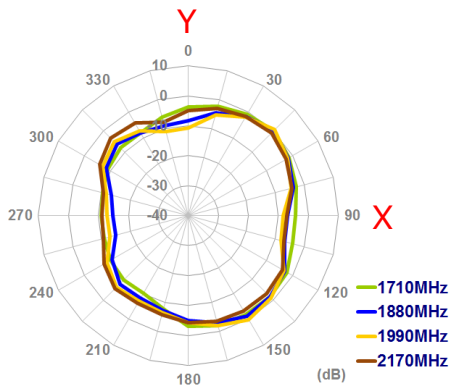
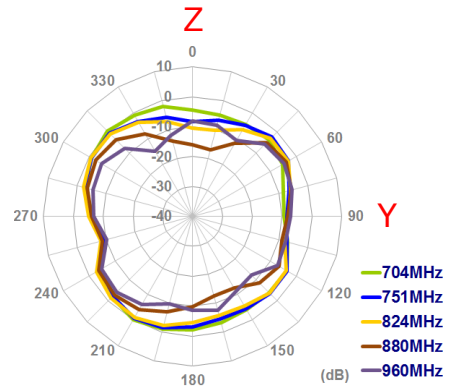

4.8 Antenna Setup – bent At 90 Degrees With 30cm X 30cm Ground Plane Center

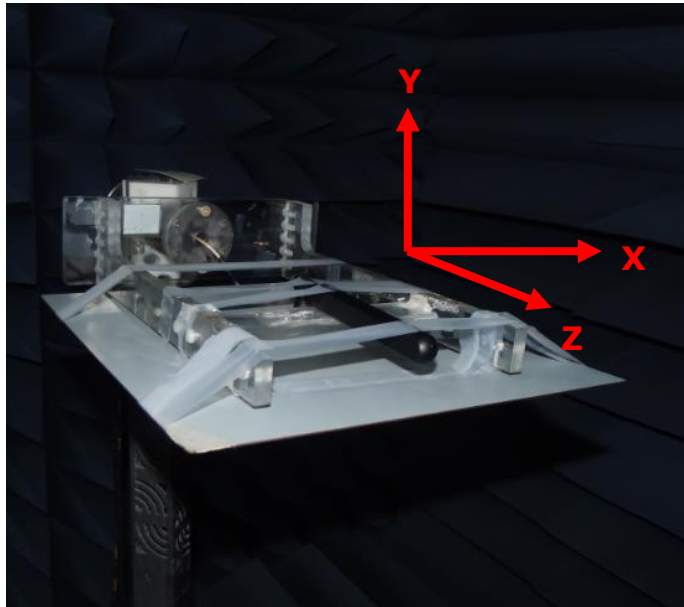

Antenna bent 90 degrees with 30cm x 30cm ground plane center

4.15. Antenna Radiation Patterns

XY Plane

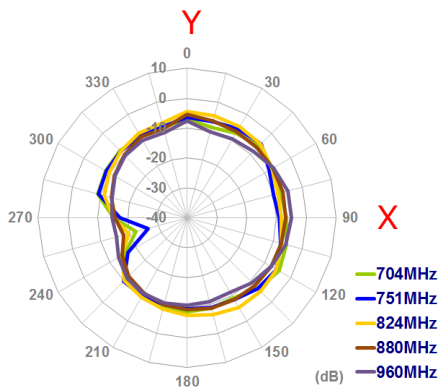

XZ Plane

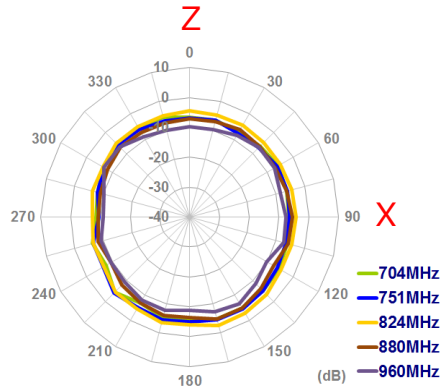

YZ Plane

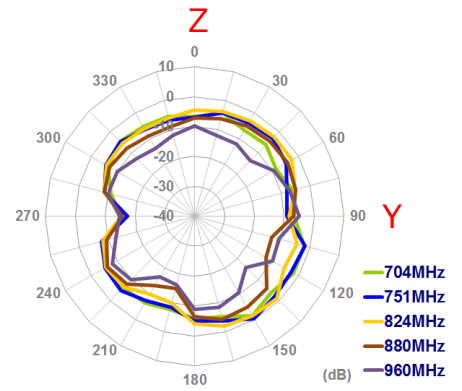

XY Plane

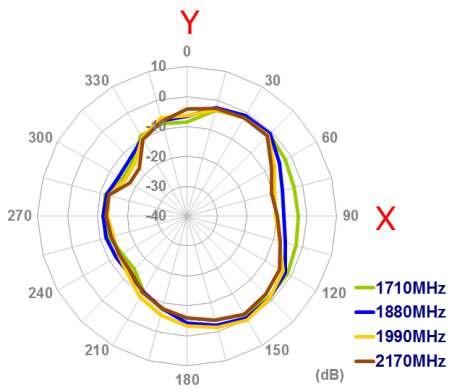

XZ Plane

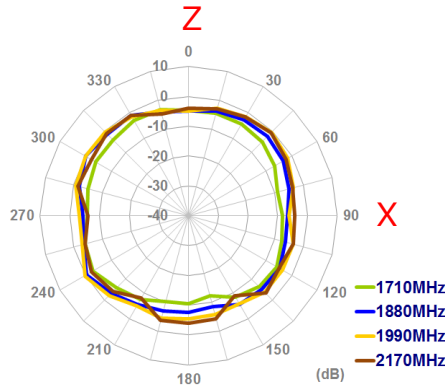

XZ Plane

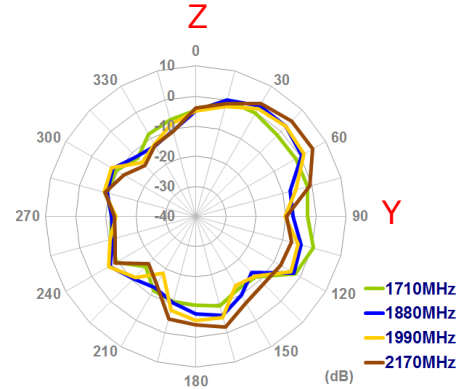

XY Plane

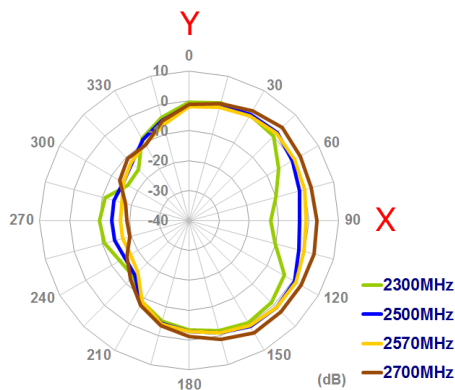

XZ Plane

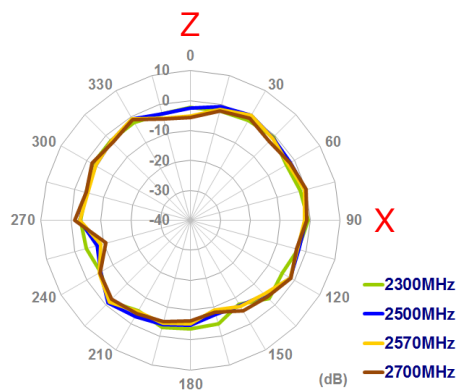

XZ Plane

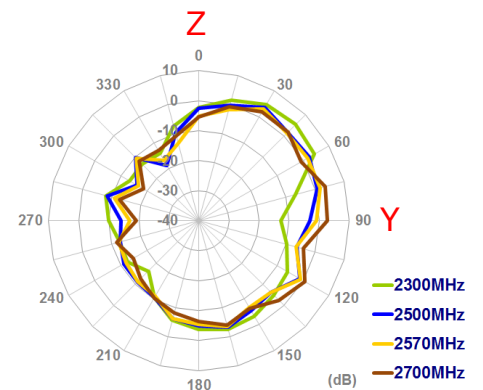

5. Drawing

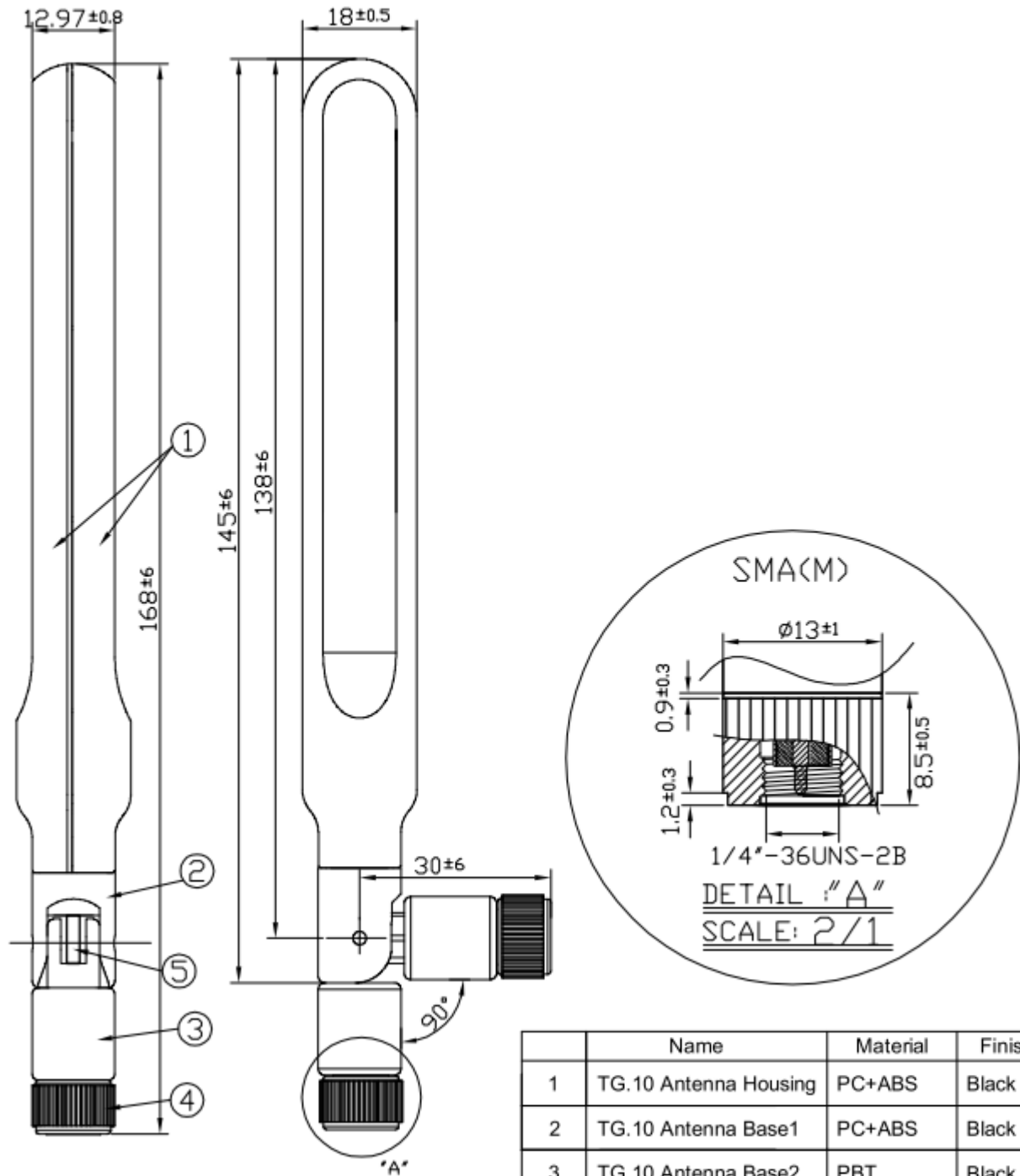

	Name	Material	Finish	QTY
1	TG.10 Antenna Housing	PC+ABS	Black	2
2	TG.10 Antenna Base1	PC+ABS	Black	1
3	TG.10 Antenna Base2	PBT	Black	1
4	SMA(M)	Brass	Black	1
5	RG178 Cable	RG178	Brown	1

7. Installation

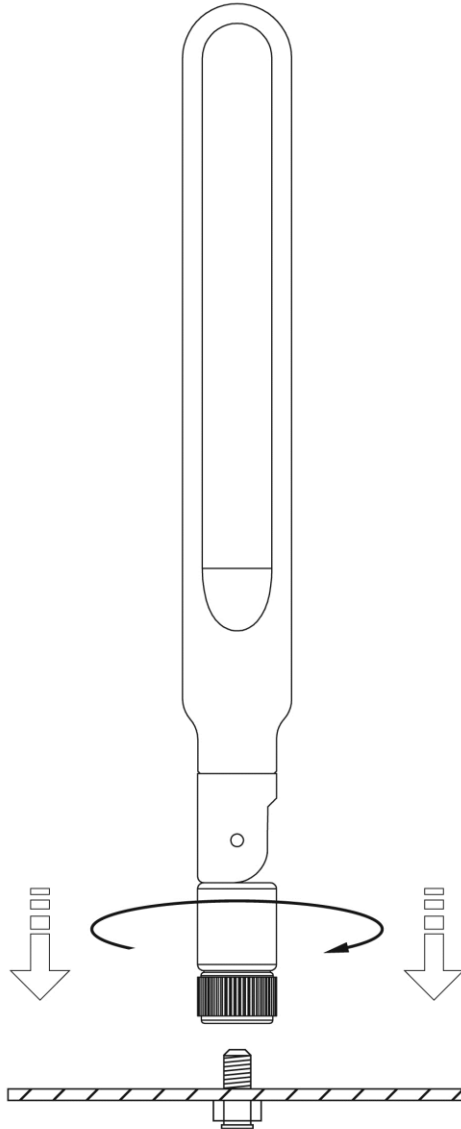

Recommended torque for mounting is 0.9 N·m
 Maximum torque for mounting is 1.176 N·m