

LQW15AWR16H80#

“#” indicates a package specification code.

Size Code 1005 (0402) in mm (in inch), Wound Type



< List of part numbers with package codes >

LQW15AWR16H80B LQW15AWR16H80D

Appearance & Shape

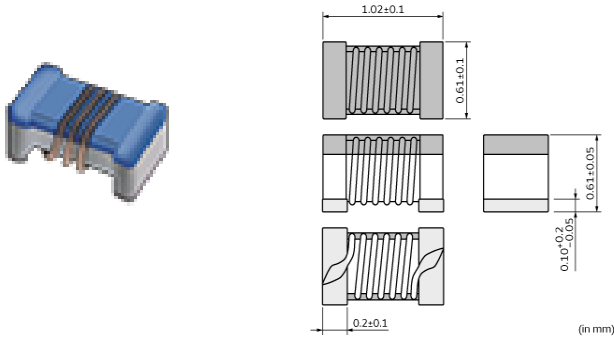

References

Packaging	Specifications	Standard Packing Quantity
B	Bulk(Bag)	500
D	180mm Paper Tape	10000

Mass (typ.)	
1 piece	0.0012g

Attention

- This datasheet is downloaded from the website of Murata Manufacturing Co., Ltd. Therefore, its specifications are subject to change or our products in it may be discontinued without advance notice. Please check with our sales representatives or product engineers before ordering.
- This datasheet has only typical specifications because there is no space for detailed specifications. Therefore, please review our product specifications or consult the approval sheet for product specifications before ordering.

LQW15AWR16H80#

“#” indicates a package specification code.



Specifications

L size	1.02±0.1mm
W size	0.61±0.1mm
T size	0.61±0.05mm
Size code inch (mm)	0402 (1005)
Inductance	160nH±3%
Inductance Test Frequency	100MHz
Rated current (Itemp) (Based on Temperature rise)	280mA
Max. of DC resistance	1.86Ω
Operating Temperature Range (Self-temperature rise is included)	-40°C to 140°C
Q(min.)	33
Q Test Frequency	250MHz
Self resonance frequency (min.)	1.3GHz
Series	LQW15AW_80

Attention

1.This datasheet is downloaded from the website of Murata Manufacturing Co., Ltd. Therefore, it's specifications are subject to change or our products in it may be discontinued without advance notice. Please check with our sales representatives or product engineers before ordering.

2.This datasheet has only typical specifications because there is no space for detailed specifications.

Therefore, please review our product specifications or consult the approval sheet for product specifications before ordering.

LQW15AWR16H80#

“#” indicates a package specification code.

Notice For General

In operating temperatures exceeding +85°C, derating of current is necessary for the LQW15AW_80 series. Please apply the derating curve shown in the chart according to the operating temperature.

Derating of Rated Current

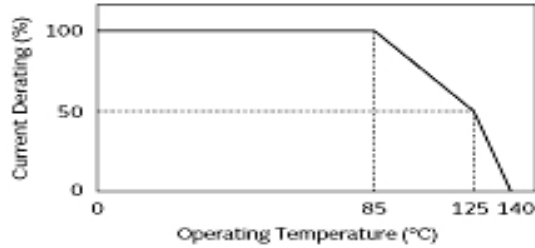

Attention

1.This datasheet is downloaded from the website of Murata Manufacturing Co., Ltd. Therefore, it's specifications are subject to change or our products in it may be discontinued without advance notice. Please check with our sales representatives or product engineers before ordering.

2.This datasheet has only typical specifications because there is no space for detailed specifications.

Therefore, please review our product specifications or consult the approval sheet for product specifications before ordering.

LQW15AWR16H80#

“#” indicates a package specification code.

Characteristic Data

The charts below may show another part number which shares its characteristics.

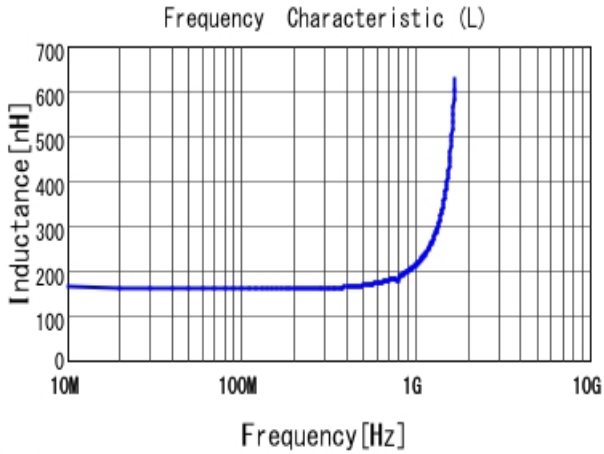

■ LQW15AWR16H80 L

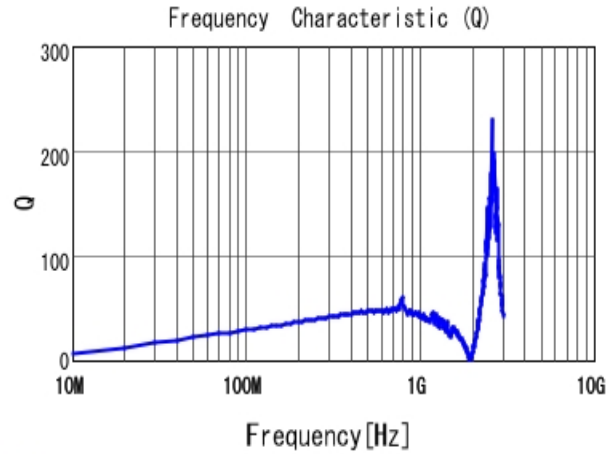

■ LQW15AWR16H80 Q

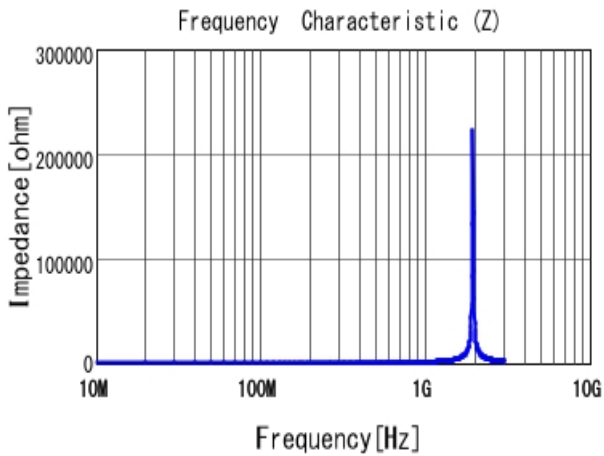

■ LQW15AWR16H80 |Z|

Attention

- 1.This datasheet is downloaded from the website of Murata Manufacturing Co., Ltd. Therefore, it's specifications are subject to change or our products in it may be discontinued without advance notice. Please check with our sales representatives or product engineers before ordering.
- 2.This datasheet has only typical specifications because there is no space for detailed specifications.
Therefore, please review our product specifications or consult the approval sheet for product specifications before ordering.