

Hyperfast Rectifier, 15 A FRED Pt® G5

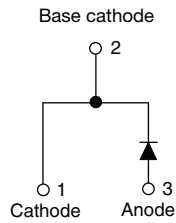

FEATURES

- Hyperfast and optimized Q_{rr}
- Best in class forward voltage drop and switching losses trade off
- Optimized for high speed operation
- 175 °C maximum operating junction temperature
- Polyimide passivation
- Material categorization: for definitions of compliance please see www.vishay.com/doc?99912



RoHS
COMPLIANT
HALOGEN
FREE

LINKS TO ADDITIONAL RESOURCES



3D Models

PRIMARY CHARACTERISTICS	
$I_{F(AV)}$	15 A
V_R	1200 V
V_F at I_F at 125 °C	2.1 V
t_{rr}	29 ns
T_J max.	175 °C
Package	2L TO-220AC
Circuit configuration	Single

DESCRIPTION / APPLICATIONS

Featuring a unique combination of low conduction and switching losses, this rectifier is the right choice for high frequency converters, both soft switched / resonant. Specifically designed to improve efficiency of PFC and output rectification stages of EV / HEV battery charging stations, booster stage of solar inverters and UPS applications, these devices are perfectly matched to operate with MOSFETs or high speed IGBTs.

MECHANICAL DATA

Case: 2L TO-220AC

Molding compound meets UL 94 V-0 flammability rating

Terminals: matte tin plated leads, solderable per J-STD-002 and JESD 22-B102

Polarity: as per marking device details

ABSOLUTE MAXIMUM RATINGS				
PARAMETER	SYMBOL	TEST CONDITIONS	VALUES	UNITS
Repetitive peak reverse voltage	V_{RRM}		1200	V
Average rectified forward current	$I_{F(AV)}$	$T_C = 98\text{ °C}$, $D = 0.50$	15	A
Repetitive peak forward current	I_{FRM}	$T_C = 98\text{ °C}$, $D = 0.50$, $f = 20\text{ kHz}$	30	
Non-repetitive peak surge current	I_{FSM}	$T_C = 45\text{ °C}$, $t_p = 10\text{ ms}$, sine wave	110	
Operating junction and storage temperature	T_J , T_{Stg}		-55 to +175	°C

ELECTRICAL SPECIFICATIONS ($T_J = 25\text{ °C}$ unless otherwise specified)						
PARAMETER	SYMBOL	TEST CONDITIONS	MIN.	TYP.	MAX.	UNITS
Breakdown voltage, blocking voltage	V_{BR} , V_R	$I_R = 100\text{ }\mu\text{A}$	1200	-	-	V
Forward voltage	V_F	$I_F = 15\text{ A}$ $I_F = 15\text{ A}$, $T_J = 125\text{ °C}$	-	2.5 2.1	3.3 -	
Reverse leakage current	I_R	$V_R = V_R$ rated $T_J = 125\text{ °C}$, $V_R = V_R$ rated	-	-	50 500	μA
Junction capacitance	C_T	$V_R = 200\text{ V}$	-	10	-	pF
Series inductance	L_S	Measured to lead 5 mm from package body	-	8	-	nH



DYNAMIC RECOVERY CHARACTERISTICS ($T_J = 25\text{ }^\circ\text{C}$ unless otherwise specified)							
PARAMETER	SYMBOL	TEST CONDITIONS	MIN.	TYP.	MAX.	UNITS	
Reverse recovery time	t_{rr}	$I_F = 1.0\text{ A}$, $di_F/dt = 100\text{ A}/\mu\text{s}$, $V_R = 30\text{ V}$	-	29	44	ns	
		$T_J = 25\text{ }^\circ\text{C}$	-	96	-		
		$T_J = 125\text{ }^\circ\text{C}$	-	137	-		
Peak recovery current	I_{RRM}	$I_F = 10\text{ A}$ $di_F/dt = 600\text{ A}/\mu\text{s}$ $V_R = 400\text{ V}$	$T_J = 25\text{ }^\circ\text{C}$	-	11.5	-	A
			$T_J = 125\text{ }^\circ\text{C}$	-	16	-	
Reverse recovery charge	Q_{rr}	$I_F = 10\text{ A}$ $di_F/dt = 600\text{ A}/\mu\text{s}$ $V_R = 400\text{ V}$	$T_J = 25\text{ }^\circ\text{C}$	-	375	-	nC
			$T_J = 125\text{ }^\circ\text{C}$	-	900	-	
Reverse recovery time	t_{rr}	$I_F = 15\text{ A}$ $di_F/dt = 1000\text{ A}/\mu\text{s}$ $V_R = 800\text{ V}$	$T_J = 25\text{ }^\circ\text{C}$	-	77.5	-	ns
			$T_J = 125\text{ }^\circ\text{C}$	-	106	-	
Peak recovery current	I_{RRM}	$I_F = 15\text{ A}$ $di_F/dt = 1000\text{ A}/\mu\text{s}$ $V_R = 800\text{ V}$	$T_J = 25\text{ }^\circ\text{C}$	-	21	-	A
			$T_J = 125\text{ }^\circ\text{C}$	-	29	-	
Reverse recovery charge	Q_{rr}	$I_F = 15\text{ A}$ $di_F/dt = 1000\text{ A}/\mu\text{s}$ $V_R = 800\text{ V}$	$T_J = 25\text{ }^\circ\text{C}$	-	680	-	nC
			$T_J = 125\text{ }^\circ\text{C}$	-	1600	-	

THERMAL - MECHANICAL SPECIFICATIONS						
PARAMETER	SYMBOL	TEST CONDITIONS	MIN.	TYP.	MAX.	UNITS
Thermal resistance, junction-to-case	R_{thJC}		-	-	1.7	$^\circ\text{C}/\text{W}$
Weight			-	2.0	-	g
			-	0.07	-	oz.
Mounting torque			6.0 (5.0)	-	12 (10)	kgf · cm (lbf · in)
Maximum junction and storage temperature range	T_J, T_{Stg}		-55	-	175	$^\circ\text{C}$
Marking device		Case style 2L TO-220AC	E5TX1512			

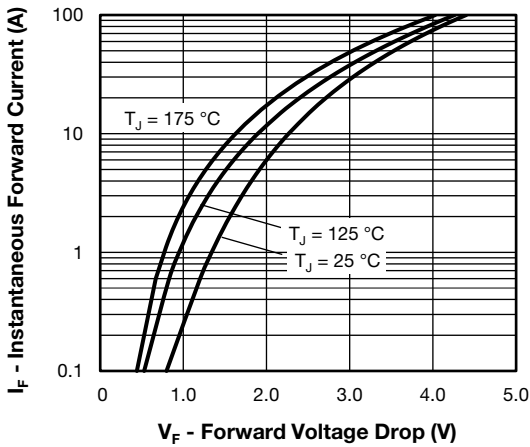

Fig. 1 - Forward Voltage Drop Characteristics

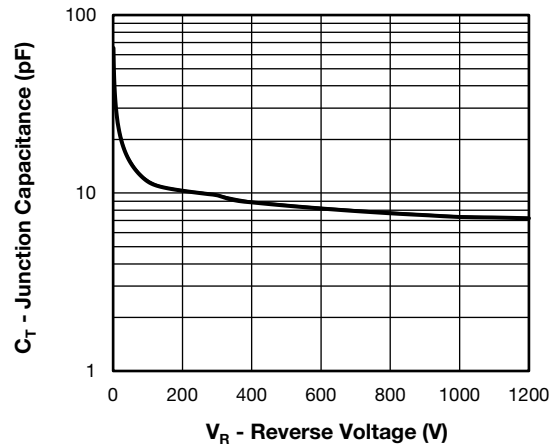

Fig. 3 - Typical Junction Capacitance vs. Reverse Voltage

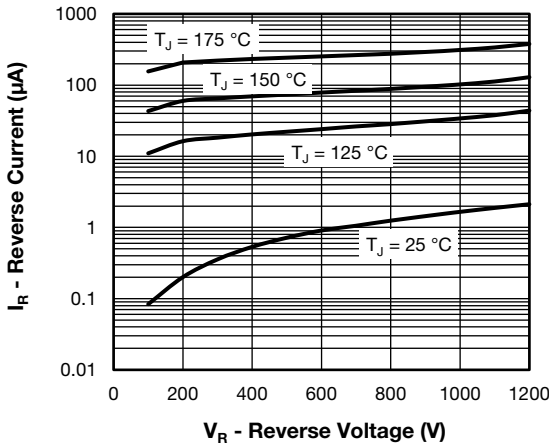

Fig. 2 - Typical Values of Reverse Current vs. Reverse Voltage

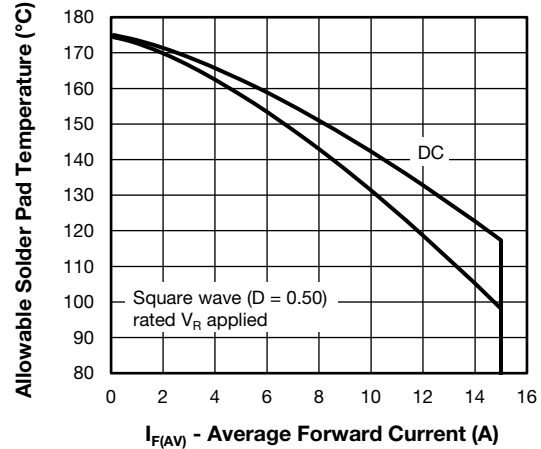

Fig. 4 - Maximum Allowable Case Temperature vs. Average Forward Current

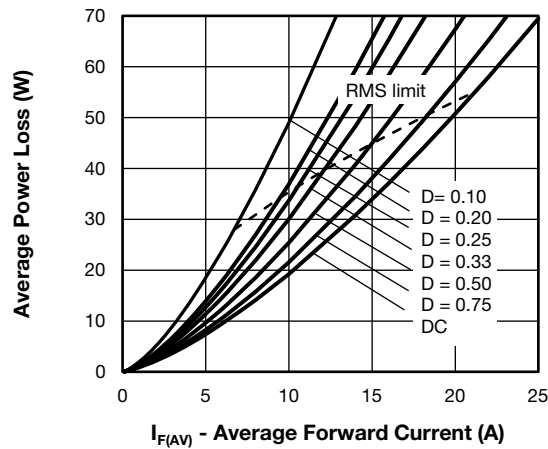

Fig. 5 - Forward Power Loss Characteristics

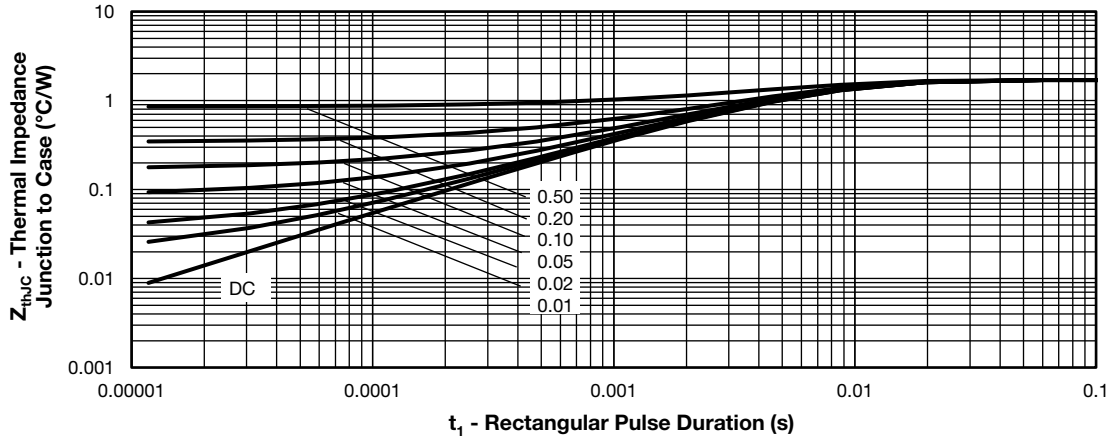

Fig. 6 - Transient Thermal Impedance, Junction to Case

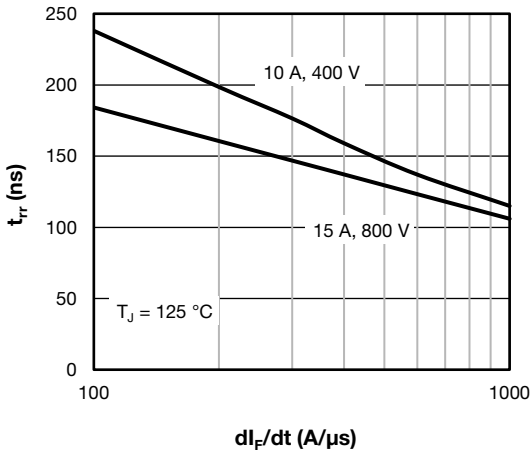

Fig. 7 - Typical Reverse Recovery Time vs. di_F/dt

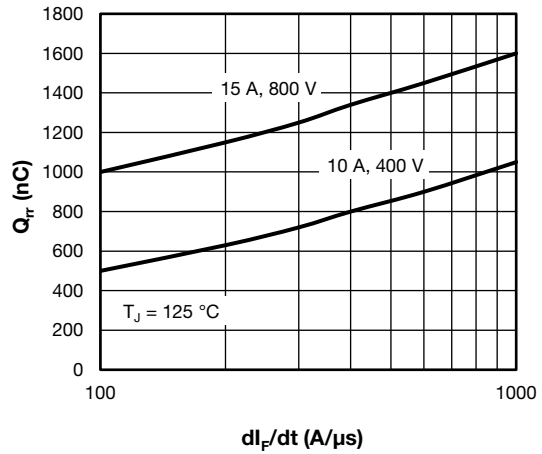

Fig. 8 - Typical Stored Charge vs. di_F/dt

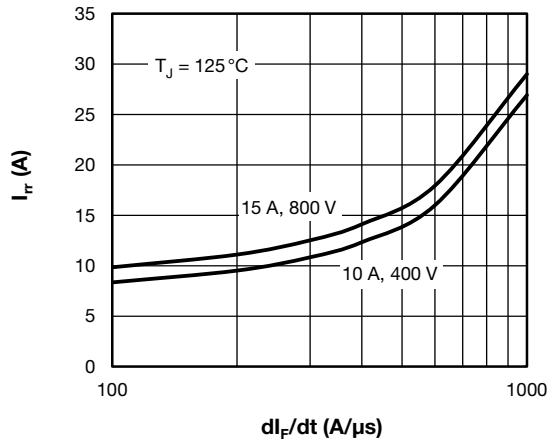

Fig. 9 - Typical Recovery Current vs. di_F/dt

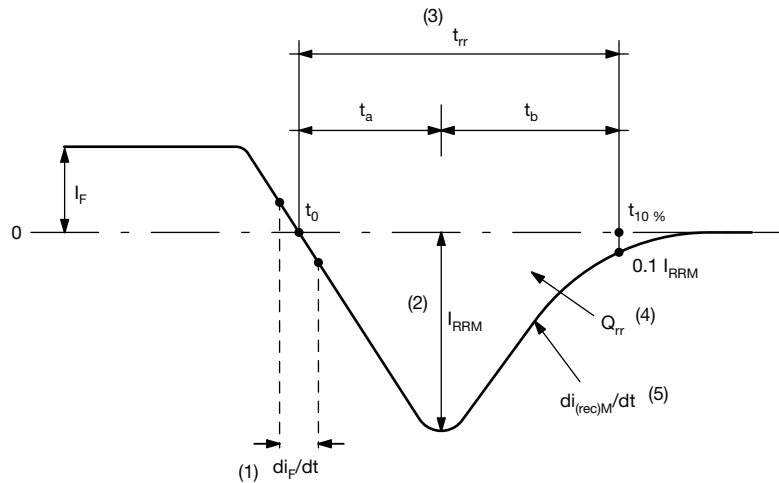

Fig. 10 - Reverse Recovery Waveform and Definitions

Notes

- (1) di_F/dt - rate of change of current through zero crossing
- (2) I_{RRM} - peak reverse recovery current
- (3) t_{rr} - reverse recovery time measured from t_0 , crossing point of negative going I_F , to point $t_{10\%}$, $0.1 I_{RRM}$
- (4) Q_{rr} - area under curve defined by t_0 and $t_{10\%}$

$$Q_{rr} = \int_{t_0}^{t_{10\%}} I(t) dt$$

- (5) $di_{(rec)M}/dt$ - peak rate of change of current during t_b portion of t_{rr}

ORDERING INFORMATION TABLE

Device code	VS-	E	5	T	X	15	12	-M3
	1	2	3	4	5	6	7	8

- | | |
|----------|--|
| 1 | - Vishay Semiconductors product |
| 2 | - E = single diode |
| 3 | - 5 = FRED generation 5 |
| 4 | - Package:
T = 2L TO-220AC |
| 5 | - X = hyperfast recovery |
| 6 | - Current rating (15 = 15 A) |
| 7 | - Voltage rating (12 = 1200 V) |
| 8 | - Environmental digit:
-M3 = halogen-free, RoHS-compliant, and termination lead (Pb)-free |

ORDERING INFORMATION (Example)			
PREFERRED P/N	QUANTITY PER TUBE	MINIMUM ORDER QUANTITY	PACKAGING DESCRIPTION
VS-E5TX1512-M3	50	1000	Antistatic plastic tube

LINKS TO RELATED DOCUMENTS	
Dimensions	www.vishay.com/doc?96154
Part marking information	www.vishay.com/doc?95391



3L TO-220AB

DIMENSIONS in millimeters and inches

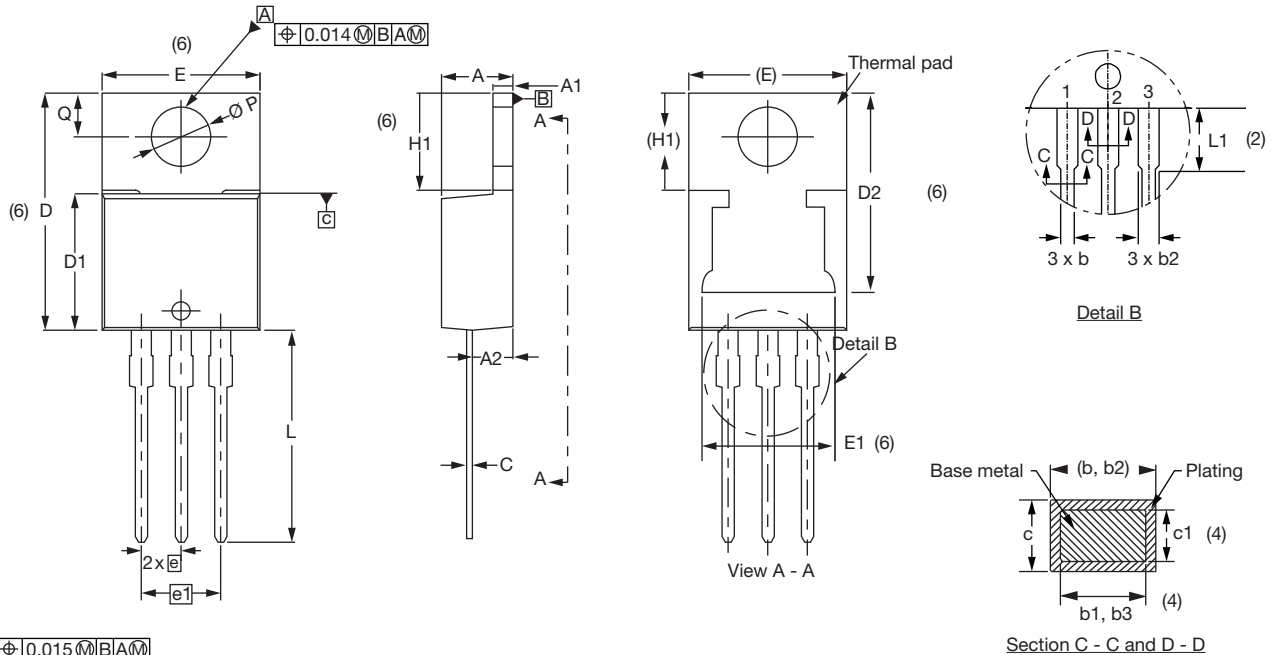

Conforms to JEDEC® outline TO-220AB

SYMBOL	MILLIMETERS		INCHES		NOTES	SYMBOL	MILLIMETERS		INCHES		NOTES
	MIN.	MAX.	MIN.	MAX.			MIN.	MAX.	MIN.	MAX.	
A	4.25	4.65	0.167	0.183		D2	11.68	13.30	0.460	0.524	6, 7
A1	1.14	1.40	0.045	0.055		E	10.11	10.51	0.398	0.414	3, 6
A2	2.50	2.92	0.098	0.115		E1	6.86	8.89	0.270	0.350	6
b	0.69	1.01	0.027	0.040		e	2.41	2.67	0.095	0.105	
b1	0.38	0.97	0.015	0.038	4	e1	4.88	5.28	0.192	0.208	
b2	1.20	1.73	0.047	0.068		H1	6.09	6.48	0.240	0.255	6
b3	1.14	1.73	0.045	0.068	4	L	13.52	14.02	0.532	0.552	
c	0.36	0.61	0.014	0.024		L1	3.32	3.82	0.131	0.150	2
c1	0.36	0.56	0.014	0.022	4	∅ P	3.54	3.91	0.139	0.154	
D	14.85	15.35	0.585	0.604	3	Q	2.60	3.00	0.102	0.118	
D1	8.38	9.02	0.330	0.355							

Notes

- (1) Dimensioning and tolerancing as per ASME Y14.5M-1994
- (2) Lead dimension and finish uncontrolled in L1
- (3) Dimension D, D1, and E do not include mold flash. Mold flash shall not exceed 0.127 mm (0.005") per side. These dimensions are measured at the outermost extremes of the plastic body
- (4) Dimension b1, b3, and c1 apply to base metal only
- (5) Controlling dimensions: inches
- (6) Thermal pad contour optional within dimensions E, H1, D2, and E1
- (7) Outline conforms to JEDEC® TO-220, except D2



Disclaimer

ALL PRODUCT, PRODUCT SPECIFICATIONS AND DATA ARE SUBJECT TO CHANGE WITHOUT NOTICE TO IMPROVE RELIABILITY, FUNCTION OR DESIGN OR OTHERWISE.

Vishay Intertechnology, Inc., its affiliates, agents, and employees, and all persons acting on its or their behalf (collectively, "Vishay"), disclaim any and all liability for any errors, inaccuracies or incompleteness contained in any datasheet or in any other disclosure relating to any product.

Vishay makes no warranty, representation or guarantee regarding the suitability of the products for any particular purpose or the continuing production of any product. To the maximum extent permitted by applicable law, Vishay disclaims (i) any and all liability arising out of the application or use of any product, (ii) any and all liability, including without limitation special, consequential or incidental damages, and (iii) any and all implied warranties, including warranties of fitness for particular purpose, non-infringement and merchantability.

Statements regarding the suitability of products for certain types of applications are based on Vishay's knowledge of typical requirements that are often placed on Vishay products in generic applications. Such statements are not binding statements about the suitability of products for a particular application. It is the customer's responsibility to validate that a particular product with the properties described in the product specification is suitable for use in a particular application. Parameters provided in datasheets and / or specifications may vary in different applications and performance may vary over time. All operating parameters, including typical parameters, must be validated for each customer application by the customer's technical experts. Product specifications do not expand or otherwise modify Vishay's terms and conditions of purchase, including but not limited to the warranty expressed therein.

Except as expressly indicated in writing, Vishay products are not designed for use in medical, life-saving, or life-sustaining applications or for any other application in which the failure of the Vishay product could result in personal injury or death. Customers using or selling Vishay products not expressly indicated for use in such applications do so at their own risk. Please contact authorized Vishay personnel to obtain written terms and conditions regarding products designed for such applications.

No license, express or implied, by estoppel or otherwise, to any intellectual property rights is granted by this document or by any conduct of Vishay. Product names and markings noted herein may be trademarks of their respective owners.