

Programmable buck converter for USB power delivery

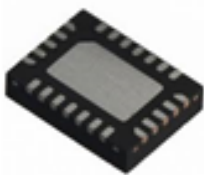

QFN 3x4 24L

Features

- Input voltage range 6.0 V to 26.4 V
- Internal power MOS synch rectification
- Internal compensation
- I²C bus controlled
- V_{out} settings: 3 V to 20 V with 20 mV (min.) steps
- Slew rate control (max. 30 mV/us)
- Cable drop compensation
- I_{out} settings: 0.1 A to 3 A with 50 mA steps
- Embedded discharge function
- Two programmable switching frequencies with optional clock dithering
- Watchdog timer set by I²C
- Configurable interrupt pin
- Soft-start
- Power-on pin
- Programmable constant current limit
- OVP, IPEAK and overtemperature protections
- Short-circuit protection
- Undervoltage lockout
- Available in QFN 3x4 24L package

Applications

- AC adapters
- USB hubs
- PC monitors
- Smart TV
- USB-PD power distribution

Description

The STPD01 is a programmable synchronous buck converter suitable to provide power supply in applications following USB power delivery specifications.

The device provides those voltages required by USB power delivery systems as stated in USB PD 3.0 spec up to 60 W output power (20 V, 3 A).

The different levels of output voltage and current limitation can be set dynamically through I²C interface.

Overvoltage, overcurrent and overtemperature protections are included in the device.

A programmable watchdog improves the robustness and the safety of the complete system.

Finally, the device is available in QFN 3x4 mm² 24L.

Product status link

STPD01

Product summary

Order code	STPD01PUR
Package	QFN 3x4 24L

1 Application schematic

Figure 1. STPD01 typical application schematic

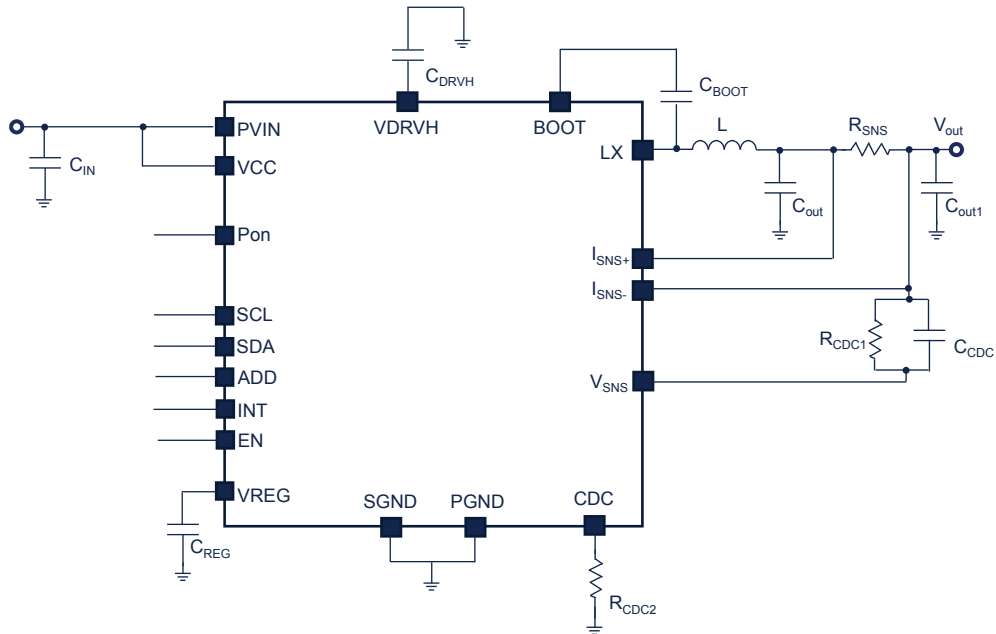
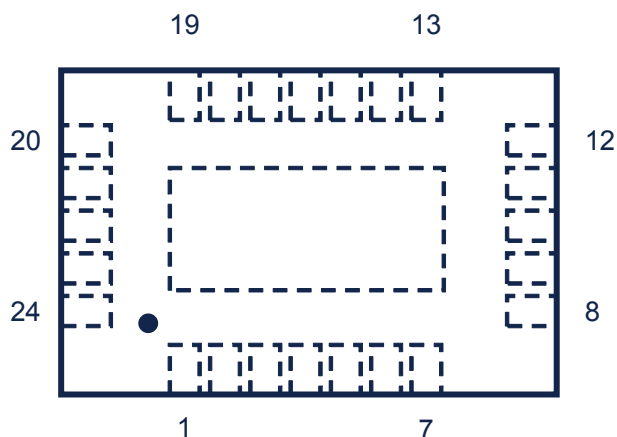

Table 1. Bill of material

Symbol	Value	Description	Note
R_{SNS}	25 m Ω 1%		
L	10 μ H	Low DCR	
C_{IN}	47 μ F	Ceramic capacitor	
C_{BOOT}	100 nF	Ceramic capacitor	
C_{OUT}	68-100 μ F	Ceramic capacitor	Spec USB PD
C_{OUT1}	10-22 μ F	Ceramic capacitor	
R_CDC1	10 k Ω		
R_CDC2	Function of R_{CABLE}		See Section 7.2 Cable drop compensation
CDRVH, CREG	1 μ F	Ceramic capacitor	

2 Pin configuration (top through view)

Figure 2. Pin configuration (top through view)

Table 2. Pin description

Position	Name	Description
1	SDA	I ² C data
2	SCL	I ² C clock
3	ADD	I ² C address selection (cannot be left floating)
4	INT	Interrupt pin (open drain output)
5	EN	Enable pin. Internally pulled up to VREG
6	VDRIVEH	High-side driver supply. Connect to a bypass capacitor
7	VCC	Analog supply input
8	PVIN	Power supply input
9	PVIN	Power supply input
10	PGND	Power ground
11	PGND	Power ground
12	PGND	Power ground
13	LX	Switching node
14	LX	Switching node
15	LX	Switching node
16	BOOT	Connect the bootstrap capacitor (0.1 μ F) between this pin and LX
17	Pon	Power-on (open drain output). Pulled high when Vout reaches the regulation value after startup
18	VREG	Internal LDO regulator voltage pin (connect 1 μ F capacitor between this pin and GND)
19	ISNS+	Positive connection for the current sensing resistor. Connect to GND if not used
20	ISNS-	Negative connection for the current sensing resistor. Connect to GND if not used
21	VSNS	Output voltage sensing pin. Used also for cable drop compensation see Section 7.2 Cable drop compensation
22	CDC	Cable drop compensation programming pin

Position	Name	Description
23	NC	Not connected. Leave floating
24	SGND	Signal ground
	EP	Exposed pad for heat dissipation, to be electrically connected to Power ground

3 Maximum ratings

Table 3. Absolute maximum ratings

Symbol	Parameter	Test conditions	Value	Unit
PVIN	Input supply	DC voltage	-0.3 to +28	V
VCC	Analog input supply	DC voltage	-0.3 to PVIN + 0.3	V
I _{SNs+} , I _{SNs-} , V _{SNs}	Sensing inputs	DC voltage	-0.3 to PVIN + 0.3	V
I _{SNs+} , I _{SNs-}	Differential voltage between sensing pins	DC voltage	0 to 3	V
	Current sourced by the pin	V _{ISNS+} = V _{ISNS-} < 0, (DC and AC)	10	mA
LX	Switching node	DC voltage	-0.3 to PVIN + 0.3	V
BOOT	BOOT voltage vs. GND	DC voltage	-0.3 to 34	V
	BOOT voltage vs. LX	DC voltage	-0.3 to 6	V
VDRIVEH	Internal power supply	DC voltage	-0.3 to 6	V
VREG	Internal LDO regulator voltage pin	DC voltage	-0.3 to 6	V
INT, SDA, SCL, ADD, EN, Pon	Logic pins voltage	DC voltage	-0.3 to 6	V
CDC	Analog pins voltage	DC voltage	-0.3 to 2.5	V
PGND, SGND	GND voltage	DC voltage	-0.3 to +0.3	V
ESD	Human body model	JS-001-2012	±2000	V

Table 4. Thermal data

Symbol	Parameter	QFN 3x4 24L	Unit
R _{THJA} ⁽¹⁾	Junction to ambient board thermal resistance	31	°C/W
T _J	Operating junction temperature	-40 to +125	°C
T _{STG}	Storage temperature	-65 to +150	°C
T _{LEAD}	Lead temperature (soldering 10 s.)	260	°C

1. Standard FR4 4 layer PCB board.

4 Electrical characteristics

Table 5. Recommended operating conditions

Symbol	Parameter	Min.	Typ.	Max.	Unit
PVIN	Input voltage	6	24	26.4	V
VCC	Analog supply voltage	Same as PVIN			
VSNS	Output voltage	3		22	V
ISNS+, ISNS-	Current sensing pins	0		22	V
Iout	Output current			3	A
EN, Pon	Analog pins			5	V
SDA, SCL, ADD, INT	Digital pins			5	V

($T_A = 25\text{ }^\circ\text{C}$, $V_{CC}=V_{IN} = 24\text{ V}$ unless otherwise specified)

Table 6. Electrical characteristics

Symbol	Parameter	Test conditions	Min.	Typ.	Max.	Unit
Power section						
I_{IN}	Active supply current ⁽¹⁾	$F_{SW}=500\text{ kHz}$, EN=HIGH, no inductor, $I_{SNS+}=0$, $I_{SNS-}=0$, $V_{SNS}=4.8\text{ V}$, reg 0x01 = 0x1D		12	18	mA
		$F_{SW}=750\text{ kHz}$, EN=HIGH, no inductor, $I_{SNS+}=0$, $I_{SNS-}=0$, $V_{SNS}=4.8\text{ V}$, reg 0x01 = 0x1D		16	22	mA
	No switching supply current ⁽¹⁾	EN=HIGH, no inductor, $I_{SNS+}=0$, $I_{SNS-}=0$, LX=HiZ, $V_{SNS}=GND$		0.9	2	mA
	Shutdown supply current ⁽¹⁾	EN=GND		16	25	uA
UVLO _H	Operating start voltage	Detect PV _{IN} rising			5.5	V
UVLO _L	Operating stop voltage	Detect PV _{IN} falling	5.0			V
VREG	Internal power supply voltage	I _{reg} = 0 mA	3.5	3.8	4.0	V
VSNS	Output voltage accuracy ⁽²⁾		-2		+2	%
Vout _{SR}	Vout transition slew rate	Absolute value			30	mV/us
ΔV_{out}	Dinamic overshoot/undershoot during voltage transition ⁽²⁾	See Section 7.5 Vout transition	-0.5		0.5	V
R _{ONHS}	High-side FET on-resistance	I _{LX} = 100 mA		50		mΩ
R _{ONLS}	Low-side FET on-resistance	I _{LX} = 100 mA		50		mΩ
SS _{SLOPE}	Soft-start slope			2.5		V/ms
F _{SW}	Switching frequency	T _J = 25 °C, reg 0x05 : bit2=0		500		kHz
		T _J = 25 °C, reg 0x05 : bit2=1		750		
DC	Duty cycle		10		9	%
I _{DSC}	Output discharge current			60		mA
Pon	Pon threshold (% of VOUT)	Lower		95		%
		Upper		105		%

Symbol	Parameter	Test conditions	Min.	Typ.	Max.	Unit
Pon	Pon deglitch			5		ms
I _{pk}	Inductor current limit thresholds	Positive		5		A
I _{valley}		Negative		3.5		
OVP	Overshoot protection threshold (VSNS/V _{nom})	VSNS sensed voltage vs. nominal vout set in the reg 0x00	1.1	1.15		V/V
	OVP deglitch			5		ms
	OVP masking time during Vout transition or fault	Start-to-end transition	275	300		ms
CC _{th}	Constant current threshold (I _{out} /I _{lim})	R _{sense} = 25 mΩ, 1% precision, 0.5 < I _{out} < 3 A		1.00		A/A
SCP	Short-circuit protection	Percentage of VSNS		20		%
	Short-circuit timer			300		ms
OTP	Overtemperature protection threshold ⁽²⁾			165		°C
	OTP hysteresys			30		°C
TW	Thermal warning	Reg 0x02		150		°C
	TW hysteresys			10		°C
η	Efficiency ⁽²⁾	V _{out} = 5 V, I _{out} = 1.5 A		85		%
		V _{out} = 9 V, I _{out} = 1.5 A		90		
		V _{out} = 15 V, I _{out} = 1.5 A		92		
		V _{out} = 20 V, I _{out} = 1.5 A		93		
SCL _f	SCL clock frequency				400	kHz
	Cable drop compensation	R _{CDC1} = 10 kΩ, R _{CDC2} = 24 kΩ, R _{SENSE} = 25 mΩ, I _{LOAD} = 1 A		200		mV
	Cable drop tolerance		-15		+15	%
	Cable drop saturation			1		V
	ISNS+, ISNS- Bias current	V _{ISNS+} = V _{ISNS-} = 20 V		100		μA
EN	ON threshold		1.2			V
	OFF threshold				0.35	
I _{EN}	Enable current	EN = GND		3	5	μA
Logic section (SCL, SDA pins)						
VOL	Low level output voltage	I _{SINK} = 2 mA			0.2	V
VIH	High level threshold voltage		1.2			V
VIL	Low level threshold voltage				0.35	V
I _{lk}	Leakage current	V _{pullup} = 3.3 V		1		uA
INT, PON pins						
Vod	Output voltage	I _{SINK} = 2 mA			0.1	V
Iod	Leakage current	V _{pullup} = 5 V			1	uA

1. Cumulative current from PVIN and V_{CC}.
2. Not tested in production.

5 Block diagram

Figure 3. STPD01 block diagram

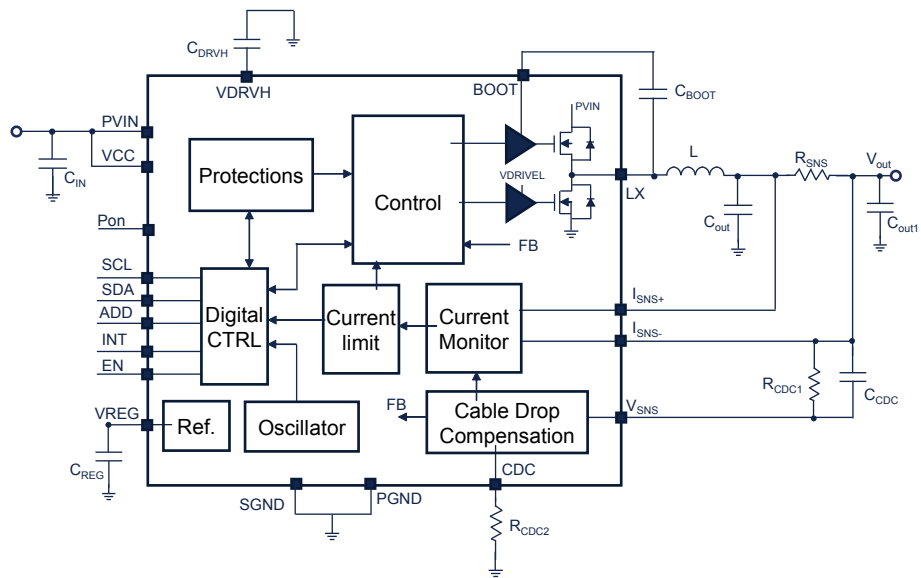

6 Typical performance characteristics

Figure 4. Efficiency ($V_{in} = V_{cc} = 24\text{ V}$, $CC = 0x1F$, $F_{sw} = 500\text{kHz}$)

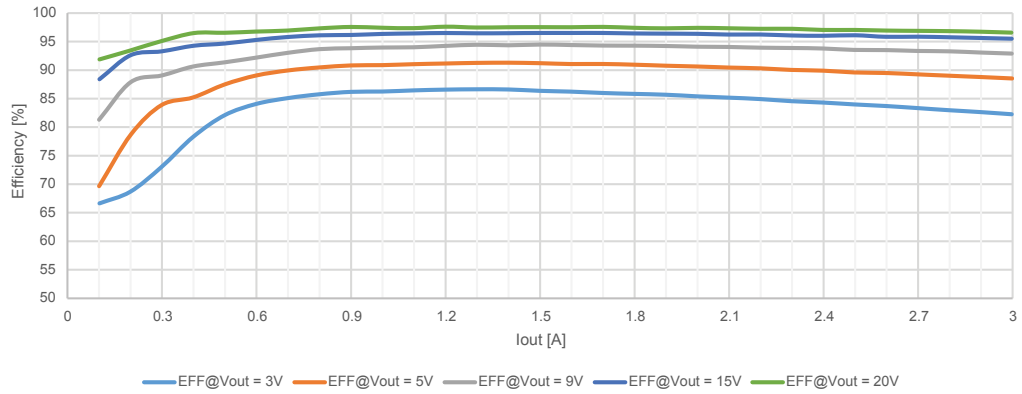

Figure 5. P_{LOSS} ($V_{in} = V_{cc} = 24\text{ V}$, $CC = 0x1F$, $F_{sw} = 500\text{ kHz}$)

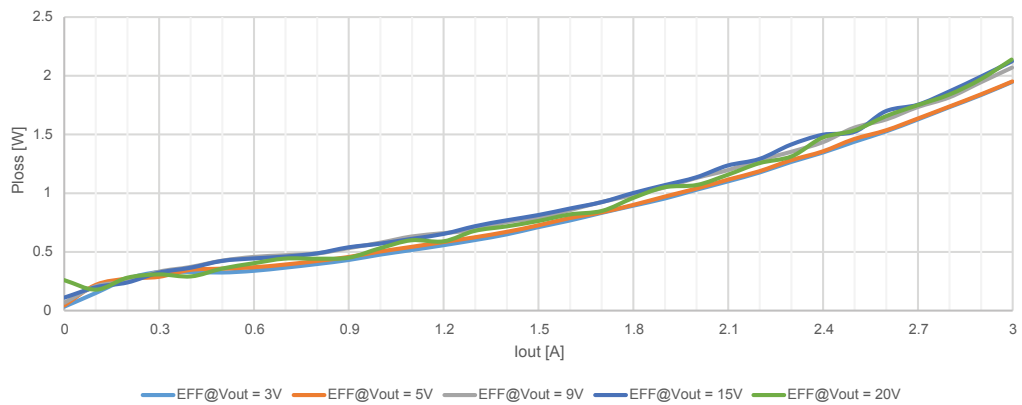

Figure 6. Efficiency ($V_{in} = V_{cc} = 24\text{ V}$, $CC = 0x1F$, $F_{sw} = 750\text{ kHz}$)

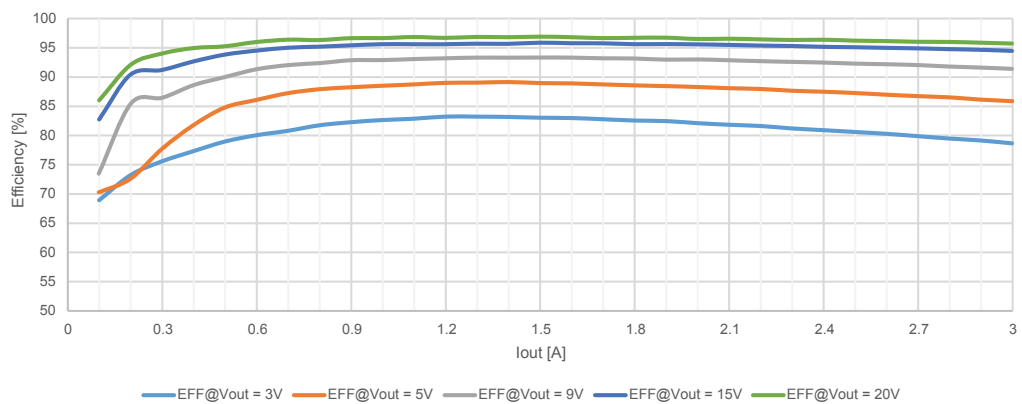

Figure 7. P_{Loss} ($V_{in} = V_{cc} = 24\text{ V}$, $CC = 0x1F$, $F_{sw} = 750\text{ kHz}$)

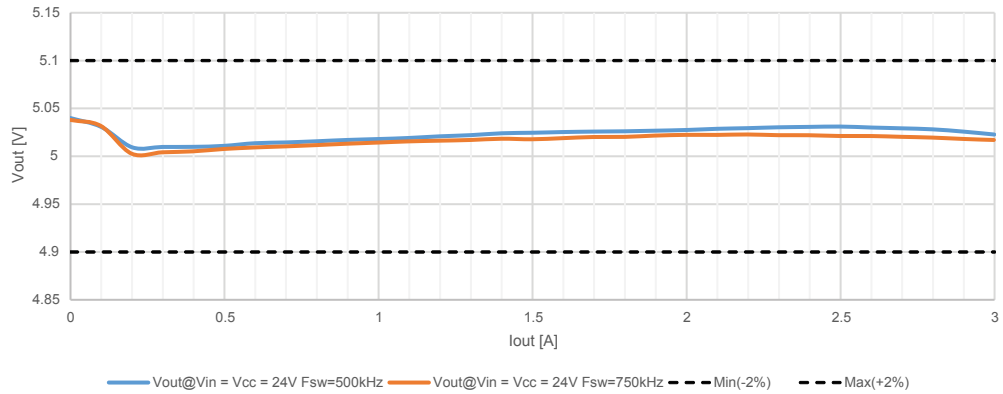

Figure 8. V_{OUT} vs. load ($V_{in} = V_{CC} = 24\text{ V}$, $V_{out} = 0x64 (5\text{ V})$, $CC = 0x1F$)

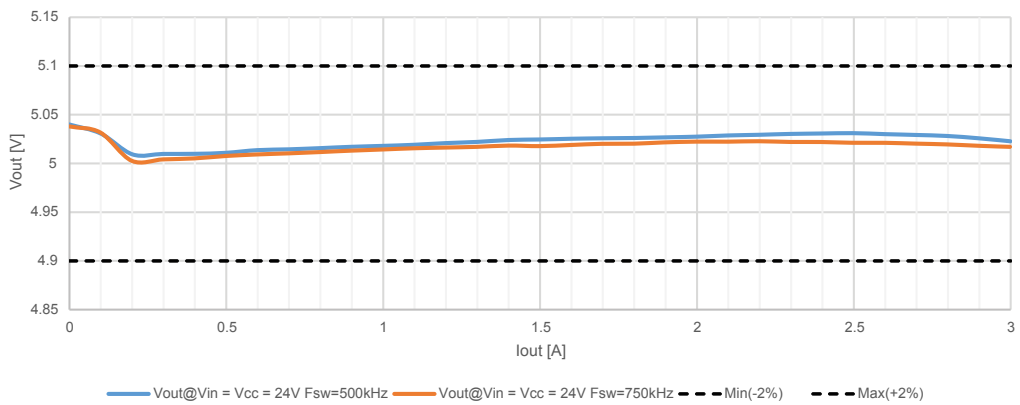

Figure 9. V_{OUT} vs. load ($V_{in} = V_{CC} = 24\text{ V}$, $V_{out} = 0xB0 (9\text{ V})$, $CC = 0x1F$)

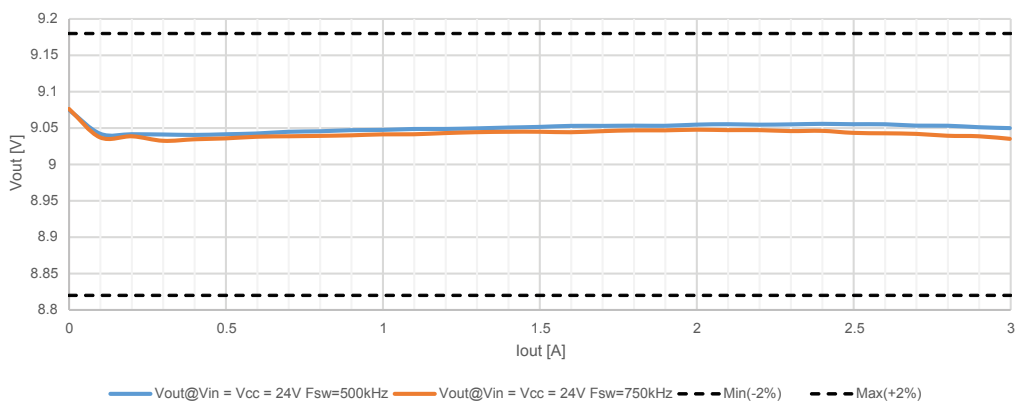

Figure 10. VOUT vs. load (Vin = VCC = 24 V, Vout = 0xD8 (15 V), CC = 0x1F)

Figure 11. VOUT vs. load (Vin = VCC = 24 V, Vout = 0xF1 (20 V), CC = 0x1F)

Figure 12. VOUT vs. load, with cable drop compensation on (Vin = VCC = 24 V, Vout = 0x64 (5 V), CC = 0x1F, R_{cdc2} = 24 kΩ, F_{sw} = 500 kHz)

Figure 13. VCDC vs. load ($V_{in} = V_{CC} = 24\text{ V}$, $V_{out} = 0x64\text{ (5 V)}$, $CC = 0x1F$, $R_{cdc2} = 24\text{ k}\Omega$, $F_{sw} = 500\text{ kHz}$)

Figure 14. VOUT vs. load, with cable drop compensation on ($V_{in} = V_{CC} = 24\text{ V}$, $V_{out} = 0x64\text{ (5 V)}$, $CC = 0x1F$, $R_{cdc2} = 6.8\text{ k}\Omega$, $F_{sw} = 500\text{ kHz}$)

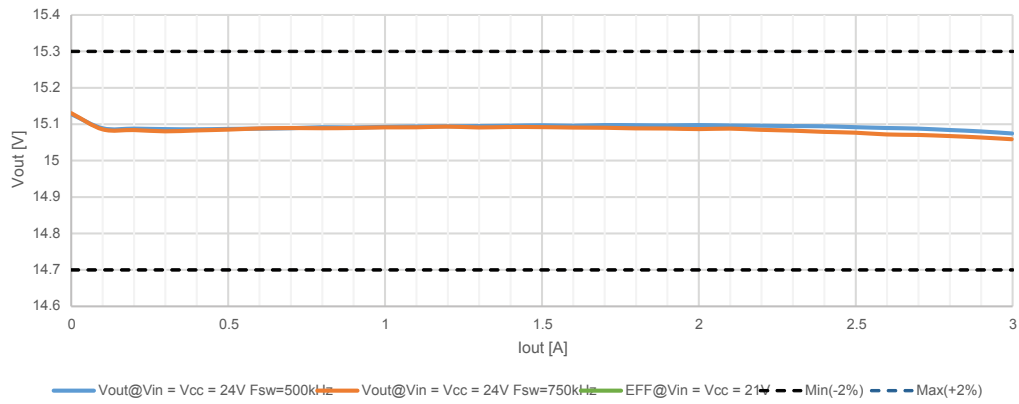
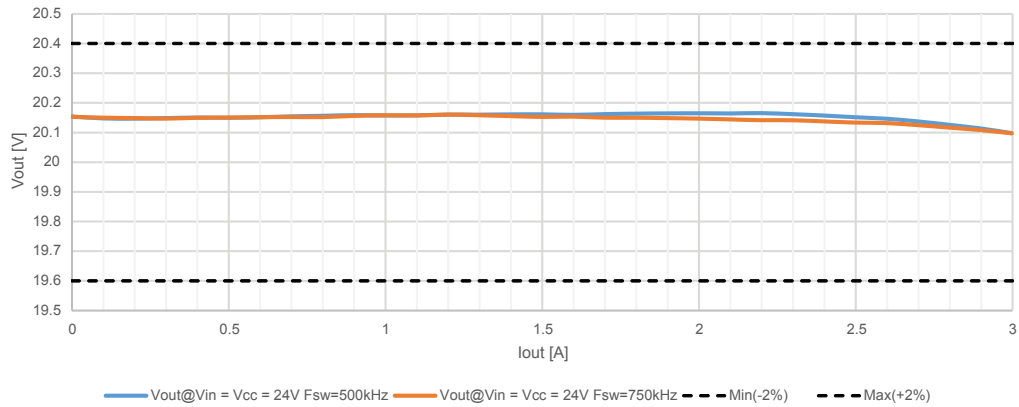
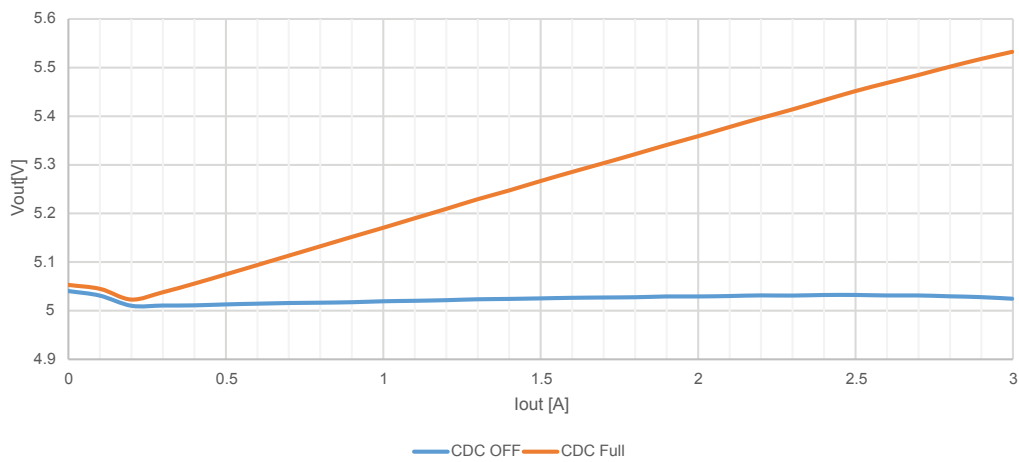
Figure 15. VCDC vs. load ($V_{in} = V_{CC} = 24\text{ V}$, $V_{out} = 0x64\text{ (5 V)}$, $CC = 0x1F$, $R_{cdc2} = 6.8\text{ k}\Omega$, $F_{sw} = 500\text{ kHz}$)

Figure 16. VOUT vs. load, with cable drop compensation on (Vin = VCC = 24 V, Vout = 0xF1 (20 V), CC = 0x1F, R_{cdc2} = 24 kΩ, F_{sw} = 500 kHz)

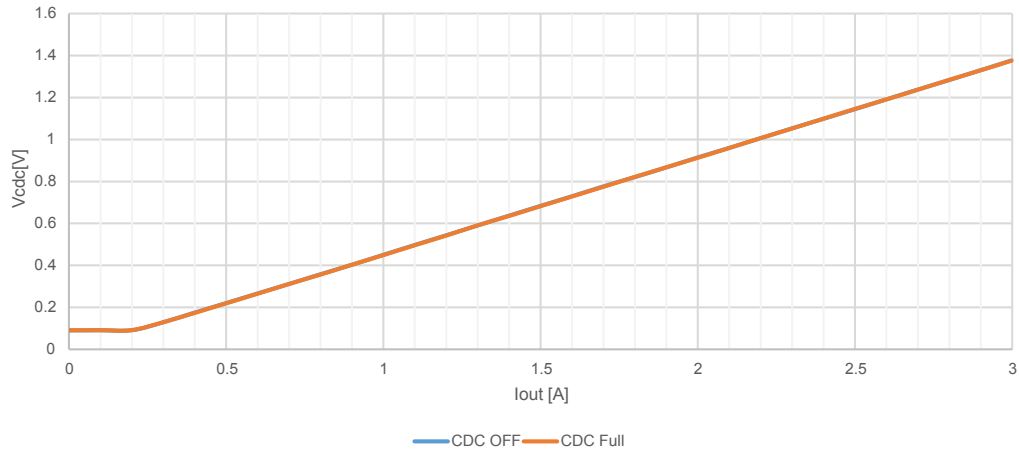
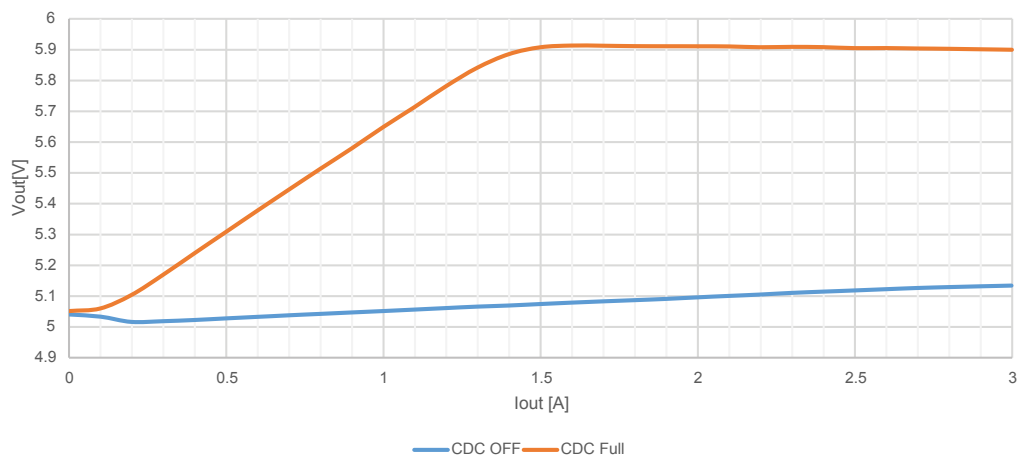
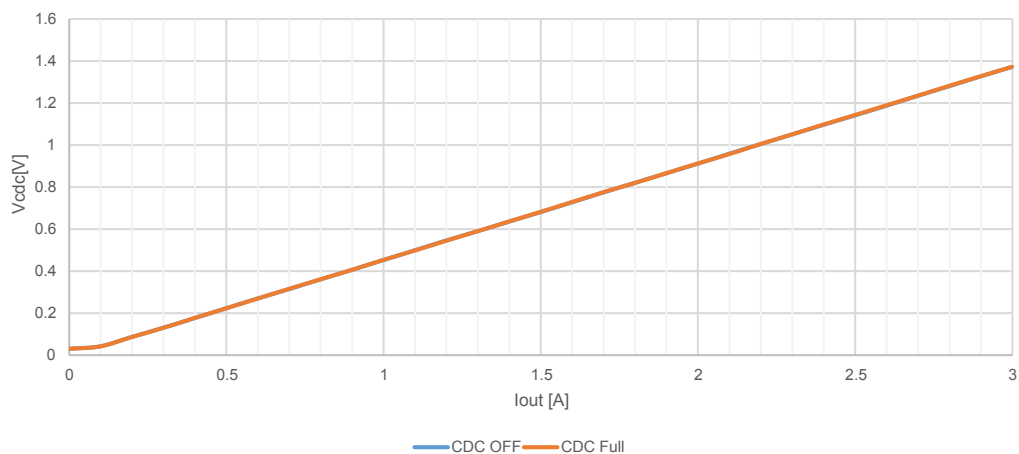
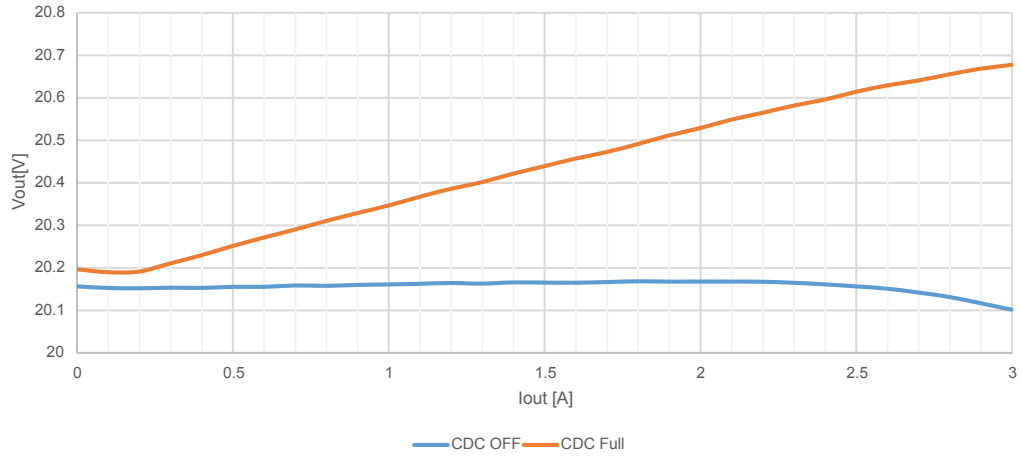

Figure 17. VCDC vs. load (Vin = VCC = 24 V, Vout = 0xF1 (20 V), CC = 0x1F, R_{cdc2} = 24 kΩ, F_{sw} = 500 kHz)

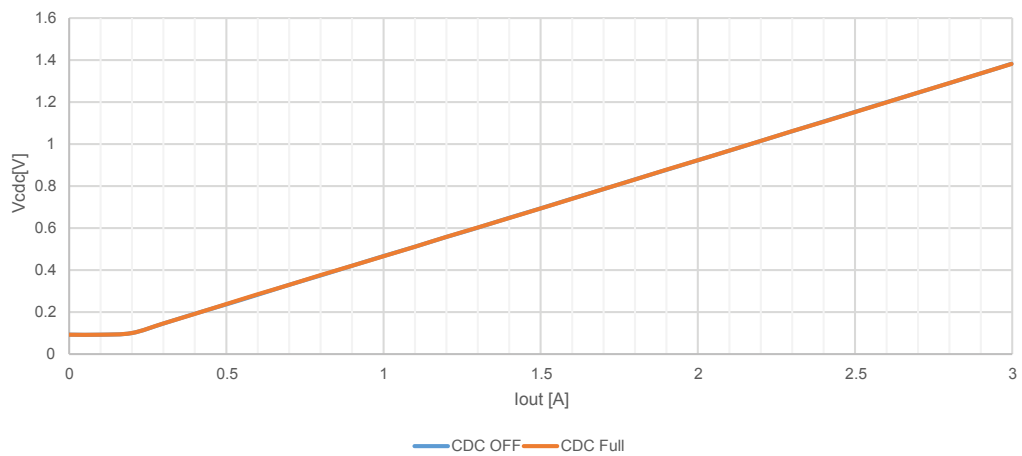

Figure 18. VOUT vs. load, with cable drop compensation on (Vin = VCC = 24 V, Vout = 0xF1 (20 V), CC = 0x1F, R_{cdc2} = 6.8 kΩ, F_{sw} = 500 kHz)

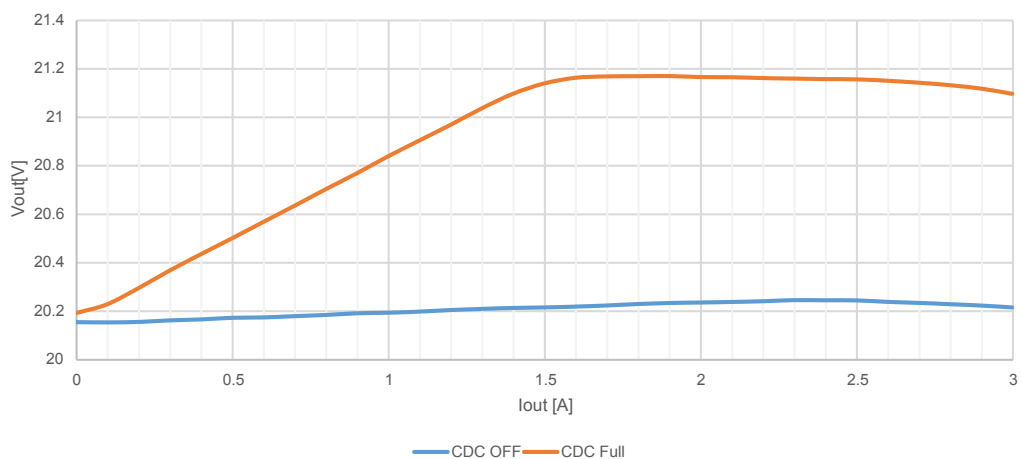

Figure 19. V_{cdc} vs. load (V_{in} = V_{CC} = 24 V, V_{out} = 0xF1 (20 V), CC = 0x1F, R_{cdc2} = 6.8 kΩ, F_{sw} = 500 kHz)

Figure 20. V_{OUT} transition (V_{in} = V_{CC} = 24 V, V_{out} = 0x64 (5 V) to 0xB0 (9 V), CC = 0x1F, load = 500 mA, F_{sw} = 500 kHz)

Figure 21. V_{OUT} transition (V_{in} = V_{CC} = 24 V, V_{out} = 0xB0 (9 V) to 0x64 (5 V), CC = 0x1F, load = 500 mA, F_{sw} = 500 kHz)

Figure 22. V_{OUT} transition (V_{in} = V_{CC} = 24 V, V_{out} = 0x64 (5 V) to 0xD8 (15 V), CC = 0x1F, load = 500 mA, F_{sw} = 500 kHz)

Figure 23. V_{OUT} transition (V_{in} = V_{CC} = 24 V, V_{out} = 0xD8 (15 V) to 0x64 (5 V), CC = 0x1F, load = 500 mA, F_{sw} = 500 kHz)

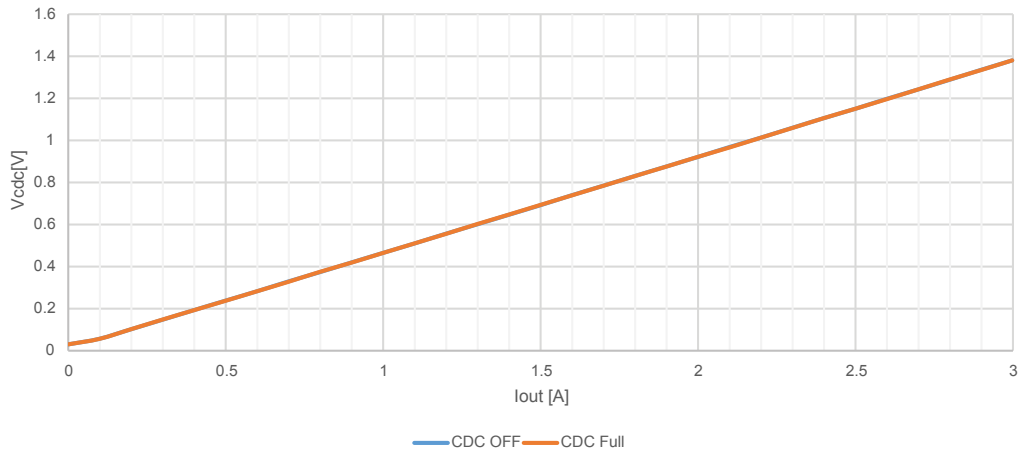
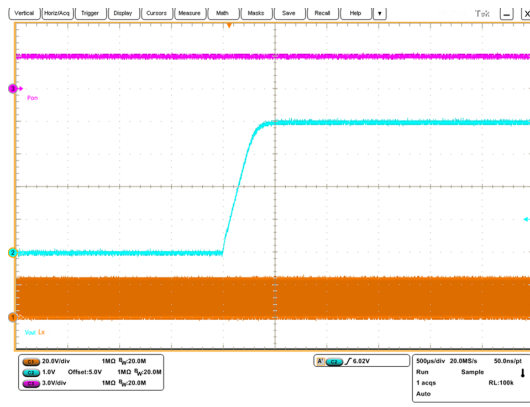
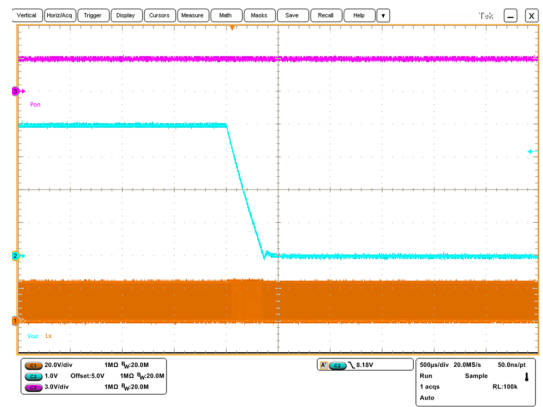
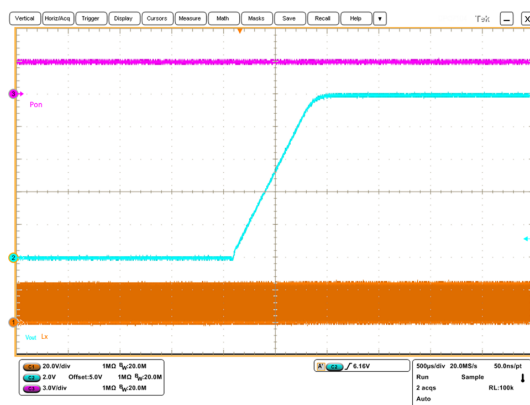
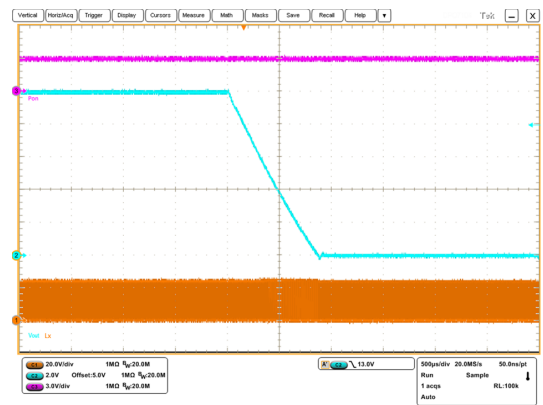
Figure 24. VOUT transition (Vin = VCC = 24 V, Vout = 0x64 (5 V) to 0xF1 (20 V), CC = 0x1F, load = 500 mA, F_{sw} = 500 kHz)

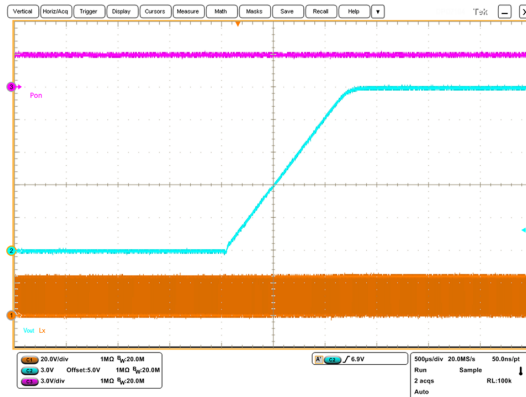

Figure 25. VOUT transition (Vin = VCC = 24 V, Vout = 0xF1 (20 V) to 0x64 (5 V), CC = 0x1F, load = 500 mA, F_{sw} = 500 kHz)

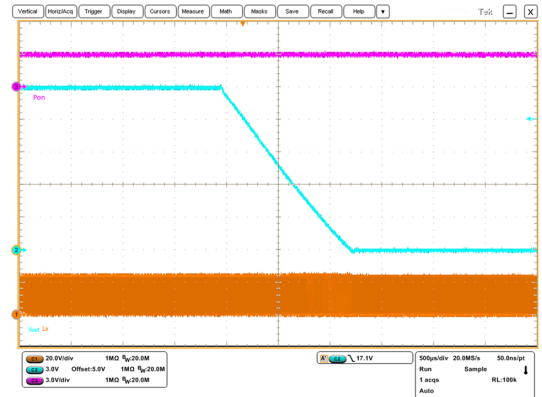

Figure 26. VOUT transition (Vin = VCC = 24 V, Vout = 0x00 (3 V) to 0x64 (5 V) to 0xF1 (20 V), CC = 0x1F, load = 500 mA, F_{sw} = 500 kHz)

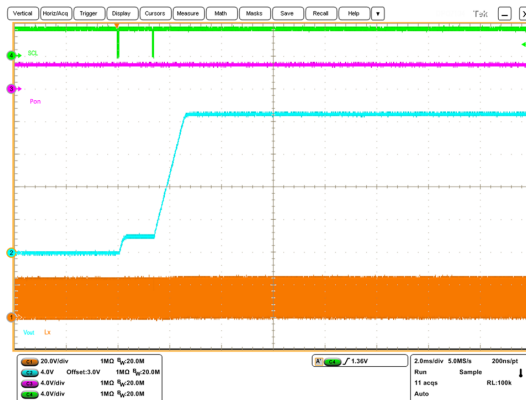

Figure 27. VOUT transition (Vin = VCC = 24 V, Vout = 0xF1 (20 V) to 0x64 (5 V) to 0x00 (3 V), CC = 0x1F, load = 500 mA, F_{sw} = 500 kHz)

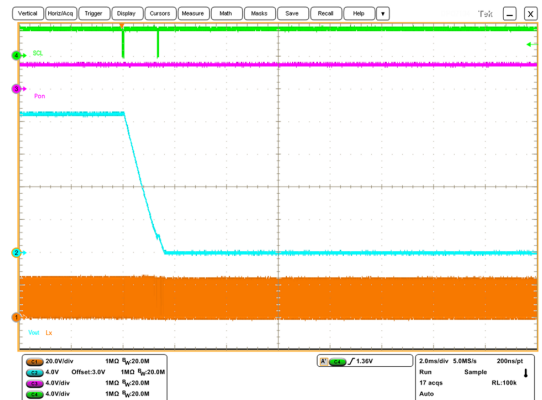

Figure 28. Enable startup (Vin = VCC = 24 V, Vout = 0x64 (5 V), no load)

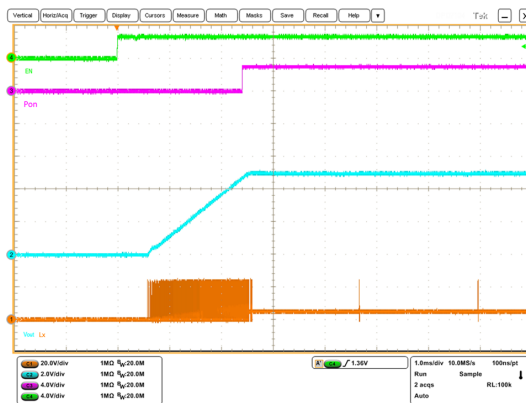

Figure 29. Enable shutdown (Vin = VCC = 24 V, Vout = 0x64 (5 V), no load)

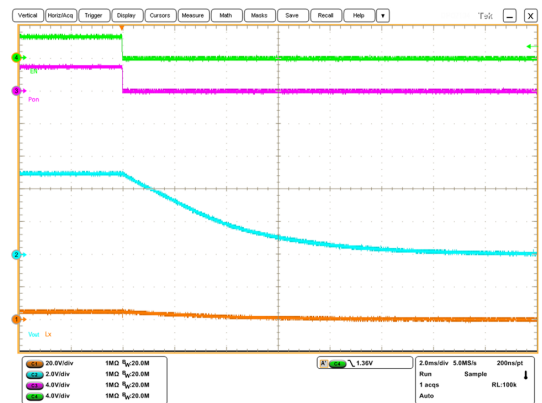
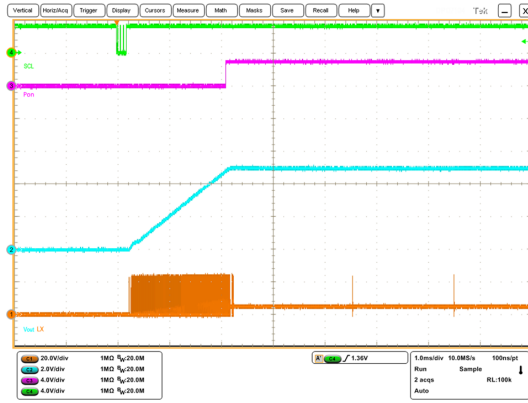
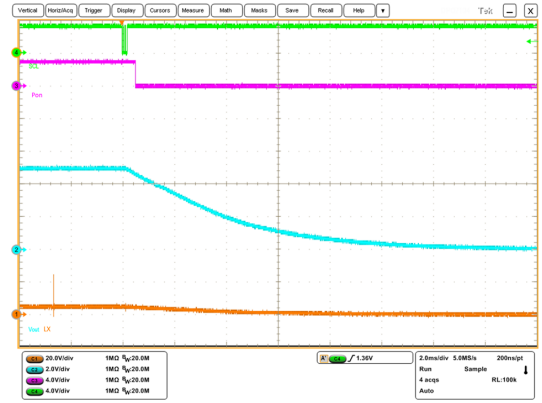

Figure 30. Digit enable startup ($V_{in} = V_{CC} = 24\text{ V}$, $V_{out} = 0x64\text{ (5 V)}$, no load)

Figure 31. Digit enable shutdown ($V_{in} = V_{CC} = 24\text{ V}$, $V_{out} = 0x64\text{ (5 V)}$, no load)

7 Operation description

7.1 Enable

The device can be forced into shutdown mode by pulling the enable pin low. In this condition, the I²C interface is switched off.

Once the EN pin voltage exceeds the threshold value, then the device immediately switches on following the start-up sequence.

7.1.1 Digital enable

The device can be enabled/disabled using the external pin EN, which switches off the DC-DC, the oscillator and the digital core completely.

Optionally, the DC-DC can be switched off by the DIG_EN bit in I²C register (0x06), but in this case the digital core is kept partially ON to allow the I²C to wake up the device.

Table 7. Functional modes

Dig_EN bit	EN pin	I ² C interface	DC-DC state	Pon
-	Low	OFF	Stop	Functional
Low	High	Functional	Stop	Functional
High	High	Functional	Operating	Functional

7.2 Cable drop compensation

In some applications, the output voltage needs to be increased proportionally to load current to compensate the potential voltage drop across copper tracks (and output cable). The compensation acts by altering the current flowing in the high-side of the voltage feedback resistor divider. The resulting compensation voltage is expressed as follows:

$$\Delta V_{out} = k \cdot I_{LOAD} \cdot R_{SENSE} \cdot (R_{CDC1}/R_{CDC2}) \tag{1}$$

where the parameter k is 18 and R_{CDC2} depends on the cable resistance, with R_{CDC1} being typically 10 kOhm.

The cable drop compensation loop should be very slow to avoid potential disturbance to the voltage loop. This can be achieved by a proper choice of R_{CDC1} and C_{CDC}.

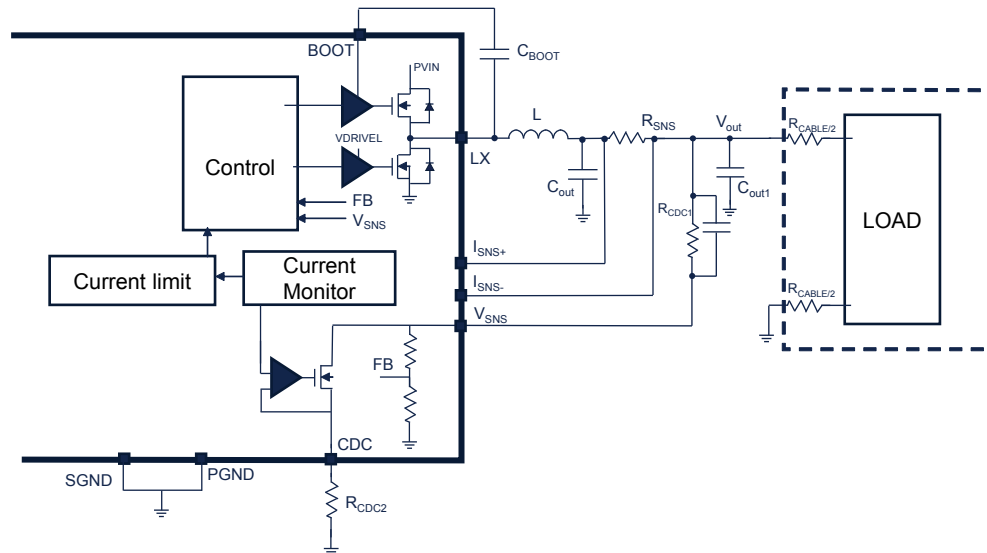
Figure 32. Cable drop configuration

7.2.1 Output current monitor

The CDC pin provides a voltage proportional to the output current according to the following formula:

$$V_{CDC} = k \times I_{LOAD} \times R_{SENSE} \quad (2)$$

where $k=18$

This formula is valid for I_{LOAD} of more than about 300 mA.

Such a feature is very useful in case the device is embedded in a system with multiple ports and power sharing, since the policy manager can read the current provided to the load regardless of I²C access.

7.3 Auto discharge

When one of the protections is triggered, the digital En bit is set or the enable pin is pulled low, the STPD01 turns on a 60 mA current sink which discharges the LX node.

The auto discharge function can be disabled by I²C in case one of the protection events occurs or in case the digital En bit is set, but it is always active when EN pin is pulled low.

7.4 Power-on

The power-on (Pon) is an open drain pin and provides information on the start-up of the device. After start-up, it detects if the output voltage is within the +/-5% window of the regulation point, in this case the Pon pin goes to high impedance.

The pin can be left floating if not used.

Figure 33. Deglitch time

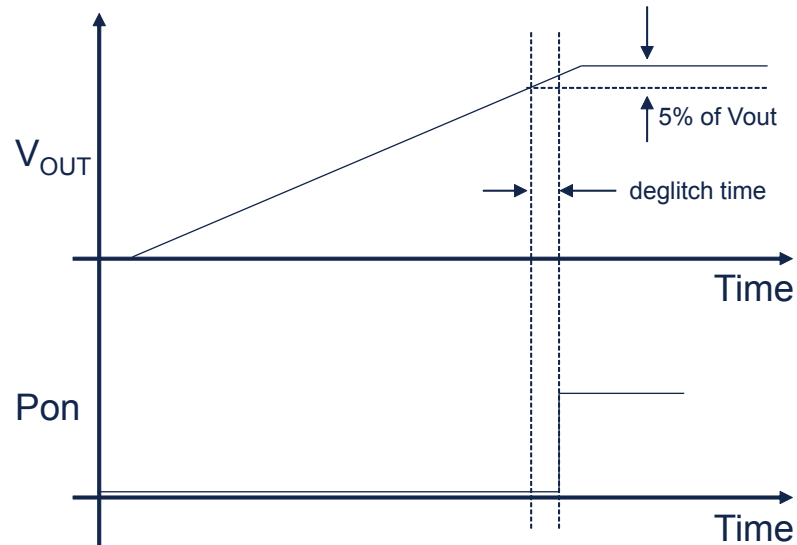

7.5 Vout transition

The Vout transitions are performed forcing the device into PWM mode in order to guarantee the max. slew rate reported in the EC table (see Table 6. Electrical characteristics).

During the transitions, the voltage level overcomes the limits defined by the $\pm 2\%$ precision. Therefore an extra margin of 500 mV (max.) is allowed for about 300 ms and OVP is masked in order to avoid false alarms.

Figure 34. Transition envelope for positive voltage transitions

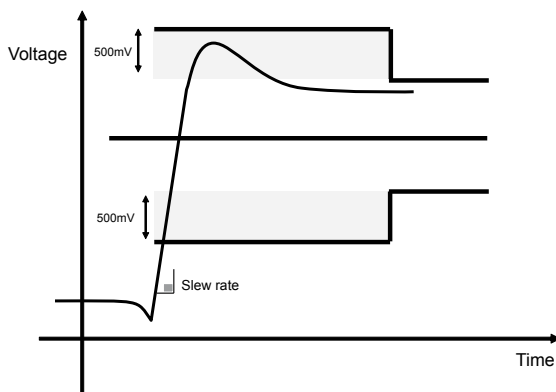
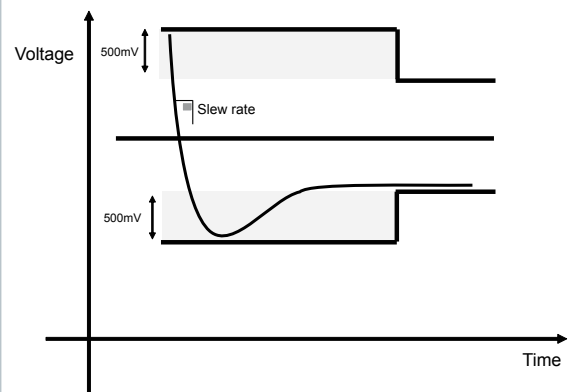
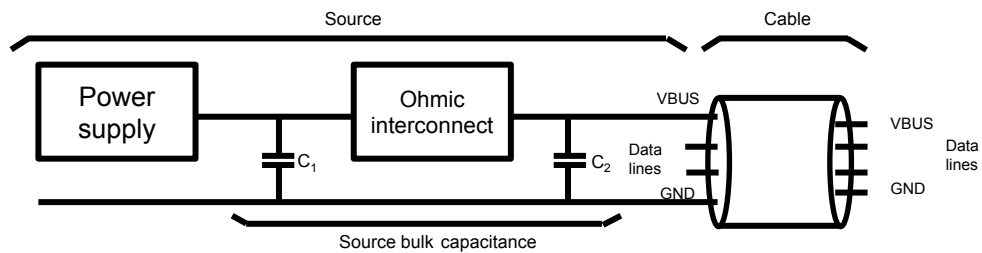

Figure 35. Transition envelope for negative voltage transitions



The maximum slew rate is guaranteed with the output capacitance value defined in the USB-PD spec. as follows:

Figure 36. Placement of source bulk capacitance

where C1 and C2 can be either a single capacitor, a capacitor bank or a distributed capacitance having a minimum value (total) of 10 μ F.

7.6 Clock dithering

To reduce EMI emission, the clock frequency dithers by 5% around its nominal value thus reducing the noise mean amplitude. This also randomly spreads the switching currents of many different STPD01 in a multi-port system.

7.7 Programmable watchdog

The STPD01 includes a watchdog function. The watchdog timer is enabled in the register 0x06. During this time, if there is no communication between the host and the STPD01, an interrupt is generated in the INT pin if not masked. Once the interrupt is activated, the host has 100 ms (default value) to send a command on the I²C to the STPD01 address, otherwise the registers 0x00, 0x01 and 0x05 are reset at their default values.

The interrupt is reset after the first I²C access.

This watchdog function can be disabled setting the bit 1 in register 0x06.

7.8 Protections

The device is equipped with some protections summarized in the following table

Table 8. Protections

Protection	Function	INT pin STATUS	Pon pin STATUS
OVP (overvoltage protection)	Active as soon as the device is enabled and PVIN/VCC voltage valid is present (above the UVLO level), even during the soft-start. The protection is triggered when the voltage sensed on the VSNS pin rises over the OVP threshold. See Section 7.8.1 Overvoltage protection for more details.	LOW	Pon goes low if Vout rises above 5% of the value set (deglitched for 5 ms). Also, in case EN pin is low, the Pon is low
CC (constant current function)	Active as soon as the device is in regulation (so, at the ends of the soft-start). This function is triggered when the output current is over the CC _{th} threshold and the device acts to overcome the voltage regulation loop to limit the output current. The VOUT drops below the programmed level.	LOW	HIGH
OTP (overtemperature protection)	Active as soon as the device is enabled and PVIN/VCC voltage valid is present (above the UVLO level), even during the soft-start. The protection is triggered when the internal temperature is over the OTP threshold and the device acts by suddenly switching off both HS and LS MOSFET. The VOUT bits (reg 0x00) and I _{lim} bits (reg 0x01) are reset. Discharge is activated if enabled by the dedicated bit.	LOW	HIGH

Protection	Function	INT pin STATUS	Pon pin STATUS
	The device follows a soft-start procedure when the temperature is below 135 °C with default output voltage value.		
SCP (short-circuit protection)	Active as soon as the device is in regulation (at the ends of the soft-start). The protection is triggered when the output voltage is under the SCP threshold and the I_{pk} threshold is detected. The device acts by suddenly switching off both HS and LS MOSFET. The device follows a soft-start procedure after 300 ms with default output voltage value. The VOUT bits (reg 0x00) and I_{lim} bits (reg 0x01) are reset.	LOW	HIGH
IPK (inductor peak current)	Active as soon as the device is enabled and PVIN/VCC voltage valid is present (above the UVLO level), even during the soft-start. The condition is checked cycle-by-cycle on the high-side and triggered once the current cross the I_{PK} threshold. The device reacts switching asynchronously (independent from oscillator frequency) between I_{pk} and I_{valley} with a given slope, dependent on L and C_{out} .	LOW	HIGH

7.8.1 Overvoltage protection

Overvoltage protection behaves in different ways depending on the state of the device.

Case A) OV during Vout transition

- In case an OV occurs during a Vout transition, the output voltage must be reset to 5 V (V_{safe}). Therefore, the following process applies:
 OV event longer than deglitch time => REG 0x00 = 0x64 => after blanking time, the half-bridge is put in high impedance if the OV condition is still present.
 In case OV lasts less than deglitch time, the event is filtered.

Case B) OV during steady-state

- Case B1) Vout=5 V**
 If OV event is detected, the half-bridge is just put in high impedance until the condition disappears.
- Case B2) Vout different than 5 V**
 The following process applies:
 OV event longer than deglitch time => REG 0x00 = 0x64 => after blanking time, the half-bridge is put in high impedance if the OV condition is still present.
 In case OV lasts less than deglitch time, the event is filtered.

7.9 Interrupt functionality

The interrupt output is activated on the edge of the fault and is reset once the fault disappears. To keep track of the fault, the corresponding bit in the INT_LTCH register is set.

Such interrupt management process allows multiple interrupt tracking. The I²C master reads the INT_LTCH register and optionally can read the INT_STAT to check if some fault is still active.

7.10 Switching frequency

The STPD01 allows two possible programmable switching frequencies (by I²C): 500 kHz (default) and 750 kHz (reg 0x05 bit 2).

7.11 Pulse skip

At light loads, the device works in discontinuous conduction mode. Zero-cross comparator is implemented to detect when the coil current crosses the zero during T_{OFF} (i.e. low-side MOSFET on). During the sleep periods of the DCM operations both power MOSFETs are off and the efficiency is improved according to that. Moreover, the sleep period is a function of the load.

Since the device works at almost fixed frequency (only 500 kHz or 750 kHz are selectable by I²C) with fixed minimum T_{on} typically 100 ns and wide PVIN range, up to 26.4 V, pulse skipping operation occurs to guarantee the proper regulation to light load (or no load conditions).

In addition, the pulse skip threshold (i.e. the voltage the device enters the pulse skip operation) can be properly selected to optimize the efficiency at light loads.

7.12 Bus timing

As shown in the figure below, the data on the SDA line must be stable during the high semi-period of the clock. The high and low-state of the data line can only change when the clock signal on the SCL line is low.

Figure 37. Data transfer validity

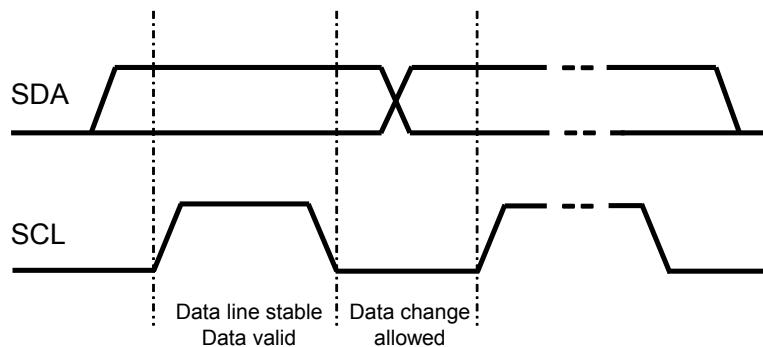

Each bus transaction begins with a “START” command which is defined as SDA transition from 1 to 0 with SCL high, and it is finished with a “STOP” command, which is defined as SDA transition from 0 to 1 with SCL high, as shown in Figure 38. START and STOP commands.

Figure 38. START and STOP commands

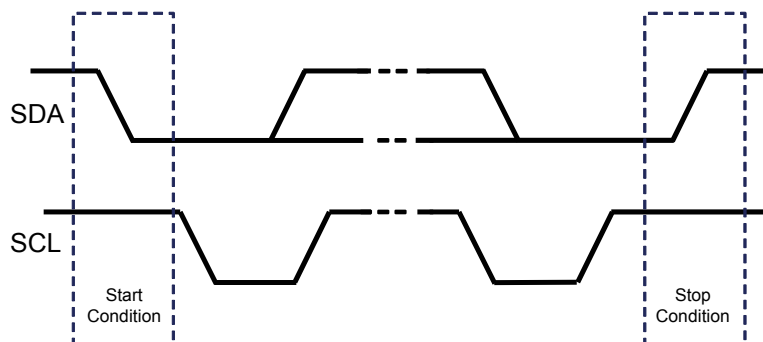

The master generates the start command and transmits the 7-bit address and the read/write bit on SDA line. All slave devices compare the address sent by the master to their internal fixed addresses. Only the slave device, with a matching address, generates an ACK by pulling the SDA line low during the entire high period of the ninth SCL clock. The acknowledge bit is used to indicate a successful byte transfer.

The master then generates further SCL cycles to either transmit data to the slave or receive data from the slave. At the end of the data transfer, the master generates the stop command and the bus is released and all devices wait for a new start command.

7.12.1 Read and write commands

The format of I²C commands is described below. All figures use common format and symbols. Every data word consists of eight bits with most significant bit first and least significant bit last.

Write command to the transceiver device is described by the following figure. It is possible to write to several consecutive registers during one write command.

Figure 39. Write command

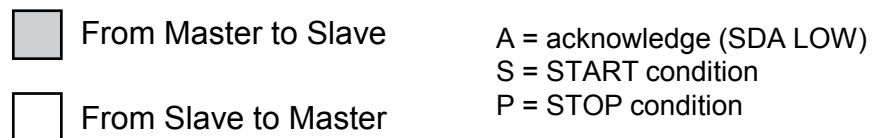
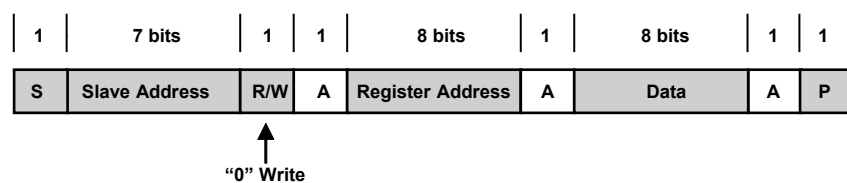

Read command consists of dummy write to set the proper address of a register followed by a real read sequence.

Figure 40. Read command

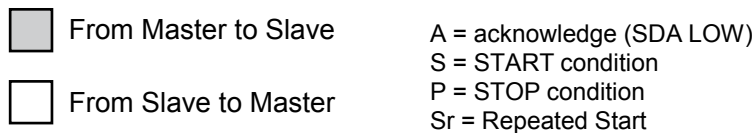

The master sends a "Repeated Start" after sending the register address and before resending the slave address. The "Repeated Start" is defined as SDA transition from 1 to 0 with SCL high.

7.12.2 I²C address selection

The I²C address can be selected using the ADD pin to allow multiple devices to be connected on the same bus. The address is composed as below:

Bit7	Bit6	Bit5	Bit4	Bit3	Bit2	Bit1	Bit0
0	0	0	0	1	ADD1	ADD0	R/W

There are four possible configurations as reported below:

Table 9. I²C address configuration

ADD connection	Bit ADD1 and ADD0
VREG	00
GND	01
SDA	10
SCL	11

8 Control register description

8.1 Register map

Table 10. Configuration bits

Content	# of configurations	Comments
Vout	240 (8 bit)	3 V to 5.9 V with 20 mV step, 5.9 V to 11 V with 100 mV step, 11 V to 20 V with 200 mV step
Ilim	25 (5 bit)	From 0.1 A to 3 A with 100 mA steps (flag_50 mA can be used to obtain 50 mA steps)
Interrupt mask	7 (7 bit)	OVP, CC, SCP, Pon, WD, OTP, OTW, IPK
Interrupt status	7 (7 bit)	Interrupt status
Interrupt latch	7 (7 bit)	Interrupt latch
Auto-discharge	2 (1 bit)	Auto-discharge enable/disable
Dithering	2 (1 bit)	Dithering enable/disable
Switching frequency	2 (1 bit)	At least 500 kHz and 750 kHz
Cable drop comp.	3 (2 bit)	OFF, full
Enable watchdog	2 (1 bit)	Enable/disable
Watchdog	4 (2 bit)	100 ms, 500 ms, 1 s, 5 s
Enable	2 (1 bit)	ON/OFF (see Section 7 Operation description)

Table 11. Register map summary

ADDR	R/W	Bit7	Bit6	Bit5	Bit4	Bit3	Bit2	Bit1	Bit0
0x00	R/W	Vout(7)	Vout(6)	Vout(5)	Vout(4)	Vout(3)	Vout(2)	Vout(1)	Vout(0)
0x01	R/W	Flag_50ma	Not used	Not used	ILIM(4)	ILIM(3)	ILIM(2)	ILIM(1)	ILIM(0)
0x02	R	INT_STAT(7)	INT_STAT(6)	INT_STAT(5)	INT_STAT(4)	INT_STAT(3)	INT_STAT(2)	INT_STAT(1)	INT_STAT(0)
0x03	R/C	INT_LTC(7)	INT_LTC(6)	INT_LTC(5)	INT_LTC(4)	INT_LTC(3)	INT_LTC(2)	INT_LTC(1)	INT_LTC(0)
0x04	R/W	INT_MASK(7)	INT_MASK(6)	INT_MASK(5)	INT_MASK(4)	INT_MASK(3)	INT_MASK(2)	INT_MASK(1)	INT_MASK(0)
0x05	R/W	WTCHDG(1)	WTCHDG(0)	Not used	CDC(1)	CDC(0)	SW_FREQ	DITH	AUTO_DIS
0x06	R/W	Not used	Not used	Not used	Not used	Not used	Not used	WD_EN	DIG_EN

R: read; R/W: read and write; R/C: cleared when read.

8.2 Register description

8.2.1 Register 0x00

The register 0x00 is used to set the output voltage configuration. Its default value (reset) is 0x64.

Table 12. 0x00 register description

Hex value	Voltage value (V)	Hex value	Voltage value (V)	Hex value	Voltage value (V)	Hex value	Voltage value (V)	Hex value	Voltage value (V)
0x00	3	0x30	3.96	0x66	5.04	0x9C	7	0xD2	13.8
0x01	3.02	0x31	3.98	0x67	5.06	0x9D	7.1	0xD3	14
0x02	3.04	0x32	4	0x68	5.08	0x9E	7.2	0xD4	14.2
0x03	3.06	0x33	4.02	0x69	5.1	0x9F	7.3	0xD5	14.4
0x04	3.08	0x34	4.04	0x6A	5.12	0xA0	7.4	0xD6	14.6
0x05	3.1	0x35	4.06	0x6B	5.14	0xA1	7.5	0xD7	14.8
0x06	3.12	0x36	4.08	0x6C	5.16	0xA2	7.6	0xD8	15
0x07	3.14	0x37	4.1	0x6D	5.18	0xA3	7.7	0xD9	15.2
0x08	3.16	0x38	4.12	0x6E	5.2	0xA4	7.8	0xDA	15.4
0x09	3.18	0x39	4.14	0x6F	5.22	0xA5	7.9	0xDB	15.6
0x0A	3.2	0x3A	4.16	0x70	5.24	0xA6	8	0xDC	15.8
0x0B	3.22	0x3B	4.18	0x71	5.26	0xA7	8.1	0xDD	16
0x0C	3.24	0x3C	4.2	0x72	5.28	0xA8	8.2	0xDE	16.2
0x0D	3.26	0x3D	4.22	0x73	5.3	0xA9	8.3	0xDF	16.4
0x0E	3.28	0x3E	4.24	0x74	5.32	0xAA	8.4	0xE0	16.6
0x0F	3.3	0x3F	4.26	0x75	5.34	0xAB	8.5	0xE1	16.8
0x10	3.32	0x40	4.28	0x76	5.36	0xAC	8.6	0xE2	17
0x11	3.34	0x41	4.3	0x77	5.38	0xAD	8.7	0xE3	17.2
0x12	3.36	0x42	4.32	0x78	5.4	0xAE	8.8	0xE4	17.4
0x13	3.38	0x43	4.34	0x79	5.42	0xAF	8.9	0xE5	17.6
0x14	3.4	0x44	4.36	0x7A	5.44	0xB0	9	0xE6	17.8
0x15	3.42	0x45	4.38	0x7B	5.46	0xB1	9.1	0xE7	18
0x16	3.44	0x46	4.4	0x7C	5.48	0xB2	9.2	0xE8	18.2
0x17	3.46	0x47	4.42	0x7D	5.5	0xB3	9.3	0xE9	18.4
0x18	3.48	0x48	4.44	0x7E	5.52	0xB4	9.4	0xEA	18.6
0x19	3.5	0x49	4.46	0x7F	5.54	0xB5	9.5	0xEB	18.8
0x1A	3.52	0x4A	4.48	0x80	5.56	0xB6	9.6	0xEC	19
0x1B	3.54	0x4B	4.5	0x81	5.58	0xB7	9.7	0xED	19.2
0x1C	3.56	0x4C	4.52	0x82	5.6	0xB8	9.8	0xEE	19.4
0x1D	3.58	0x4D	4.54	0x83	5.62	0xB9	9.9	0xEF	19.6
0x1E	3.6	0x4E	4.56	0x84	5.64	0xBA	10	0xF0	19.8
0x1F	3.62	0x4F	4.58	0x0x85	5.66	0xBB	10.1	0xF1	20
0x20	3.64	0x50	4.6	0x86	5.68	0xBC	10.2		
0x21	3.66	0x51	4.62	0x87	5.7	0xBD	10.3		

Hex value	Voltage value (V)	Hex value	Voltage value (V)	Hex value	Voltage value (V)	Hex value	Voltage value (V)	Hex value	Voltage value (V)
0x22	3.68	0x52	4.64	0x88	5.72	0xBE	10.4		
0x23	3.7	0x53	4.66	0x89	5.74	0xBF	10.5		
0x24	3.72	0x54	4.68	0x8A	5.76	0xC0	10.6		
0x25	3.74	0x55	4.7	0x8B	5.78	0xC1	10.7		
0x26	3.76	0x56	4.72	0x8C	5.8	0xC2	10.8		
0x27	3.78	0x57	4.74	0x8D	5.82	0xC3	10.9		
0x28	3.8	0x58	4.76	0x8E	5.84	0xC4	11		
0x29	3.82	0x59	4.78	0x8F	5.86	0xC5	11.2		
0x2A	3.84	0x5A	4.8	0x90	5.88	0xC6	11.4		
0x2B	3.86	0x5B	4.82	0x91	5.9	0xC7	11.6		
0x2C	3.88	0x5C	4.84	0x92	6	0xC8	11.8		
0x2D	3.9	0x5D	4.86	0x93	6.1	0xC9	12		
0x2E	3.92	0x5E	4.88	0x94	6.2	0xCA	12.2		
0x2F	3.94	0x5F	4.9	0x95	6.3	0xCB	12.4		
0x30	3.96	0x60	4.92	0x96	6.4	0xCC	12.6		
0x31	3.98	0x61	4.94	0x97	6.5	0xCD	12.8		
0x32	4	0x62	4.96	0x98	6.6	0xCE	13		
0x33	4.02	0x63	4.98	0x99	6.7	0xCF	13.2		
0x34	4.04	0x64	5	0x9A	6.8	0xD0	13.4		
0x35	4.06	0x65	5.02	0x9B	6.9	0xD1	13.6		

8.2.2 Register 0x01

The register 0x01 is used to set the output current limitation configuration. Its default value (reset) is 0x04, which is 500 mA.

Table 13. 0x01 register description

Hex value	I _{LIM} (mA)	Hex value	I _{LIM} (mA)
0x00	100	0x0F	1600
0x01	200	0x10	1700
0x02	300	0x11	1800
0x03	400	0x12	1900
0x04	500	0x13	2000
0x05	600	0x14	2100
0x06	700	0x15	2200
0x07	800	0x16	2300
0x08	900	0x17	2400
0x09	1000	0x18	2500
0x0A	1100	0x19	2600
0x0B	1200	0x1A	2700
0x0C	1300	0x1B	2800
0x0D	1400	0x1C	2900
0x0E	1500	0x1D	3000

8.2.3 Interrupt registers: 0x02, 0x03, 0x04

The registers 0x02, 0x03 and 0x04 are used for the interrupt management and in particular:

0x02: interrupt status (reset value 0x00), bit at 0 means “no interrupt”

0x03: interrupt latch (reset value 0x00), bit at 0 means “not latched”

0x04: interrupt mask (reset value 0x0E), bit at 0 means “not masked”

The single bits are organized as follows:

Table 14. Interrupt register description

Bit	Function	Notes
0	Overvoltage protection	
1	Constant current function	
2	Short-circuit protection	
3	Power-on	
4	Watchdog	
5	Overtemperature protection	Junction temperature 165 °C
6	Overtemperature warning	Junction temperature 145 °C
7	Inductor peak current protection	

8.2.4 Register 0x05

The register 0x05 is used for services and in particular:

Bit	Function	Notes
0	Discharge	0: OFF 1: ON (default)
1	Dithering	0: OFF (default) 1: ON
2	Switching frequency	0: 500 kHz (default) 1: 750 kHz
4:3	Cable drop compensation	00: OFF (default) 10: Full 01: N/A 11: N/A
5	Not used	-
7:6	Watchdog timer	00: 100 ms (default) 01: 500 ms 10: 1 s 11: 5 s

Default value (reset) is 0x01.

8.2.5 Register 0x06

The register 0x06 is only used for digital enable.

Bit	Function	Notes
0	Digital enable	0: OFF 1: ON (default)
1	Watchdog enable	0: OFF (default) 1: ON
7:2	To be defined	To be defined

Default value (reset) is 0x01.

9 Application notes

9.1 Board layout guidelines

Guidelines

The DC-DC converter area is very sensitive, and it is necessary to pay attention to the layout of this part. The DC-DC converter generates GND noise that can get coupled on surrounding ground reducing the sensitivity, and high-frequency components can be coupled onto RF part. So, to ensure a correct layout it is necessary to:

- Provide efficient filtering by placing capacitors as close as possible
- Reduce parasitic ensuring wide and short connections.

Four-layer boards

A four-layer board is strongly recommended. Put the ground layer very close to the top layer to obtain a good ground plane reference. A thickness between the top layer and ground layer of 0.2 mm or 0.3 mm is suggested. Put a ground plane internally to reduce the coupling between the traces

If it is not possible to use a four-layer board, it is necessary to fill the area under the phase node of the board with ground metal to reduce or eliminate radiation emissions. Board routing and wiring should not be placed in this region to prevent coupling effects and to ensure a good ground reference plane to the RF parts.

Ground plane

Any switch mode power supply requires a good PCB layout in order to achieve the maximum performance. Component placement, and GND trace routing and width are the major issues. Basic rules commonly used for DC-DC converters for good PCB layout should be followed. All traces carrying current should be drawn on the PCB as short and as thick as possible. This should be done to minimize resistive and inductive parasitic effects, and increase system efficiency. Suggested PCB (ring) ground plane to avoid spikes on the output voltage. Good soldering of the exposed pad helps on this issue.

Connect all the ground metallization and/or layers with as many vias as possible. Ground vias between layers should be added liberally throughout the RF portion of the PCB. This helps prevent accrual of parasitic ground inductance due to ground-current return paths. The vias also help to prevent cross-coupling from RF and other signal lines across the PCB.

The layers assigned to system bias (DC supply) and ground must be considered in terms of the return current for the components. The general guidance is not to have signals routed on layers between the bias layer and the ground layer.

Capacitors placing

Particular care has to be taken in the placement of the supply voltage filtering capacitors. It is, in fact, important to ensure efficient filtering placing these capacitors as close as possible from their dedicated pins on the VIN (C6), VCC (C5), VREG (C1), VHDRIVE (C3), VBOOT (C14) and VSNS (C16).

Figure 41. Capacitor placing

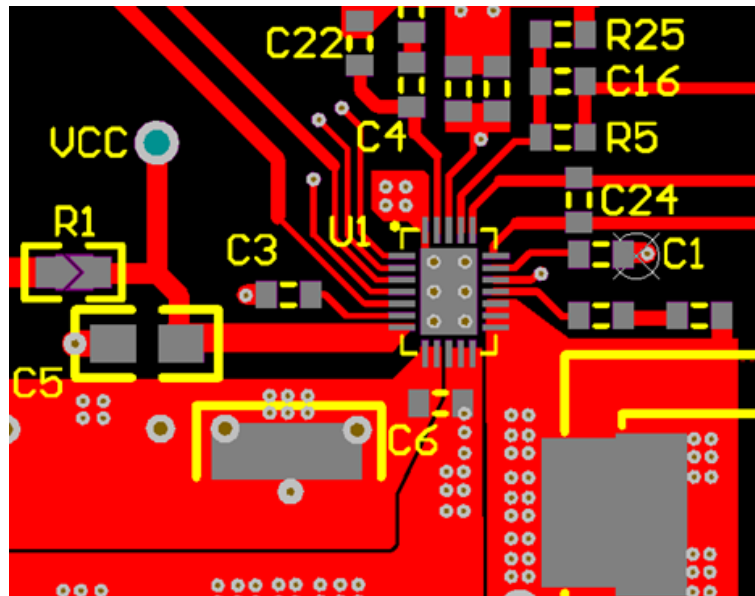

The layout of decoupling capacitors is extremely important to minimize the induction loop formed between the capacitor and the IC power and ground. The vias should be placed on the side of the capacitor lands, not the ends. The vias should be located at minimum keepout distance and connected to the capacitor lands with a wide trace - at least as wide as the via pad. Vias of opposite polarity should be placed as close together as possible (minimum keepout distance) and vias of the same polarity should be kept separated as much as possible. If space allows, a second pair of vias on the opposite side of the capacitor may be added to reduce the inductance further.

Inductor placing

The DC-DC converter inductor has to be placed as close as possible with traces as short and as thick as possible. This should be done to minimize resistive parasitic effects, and increase system efficiency.

Figure 42. Inductor placing

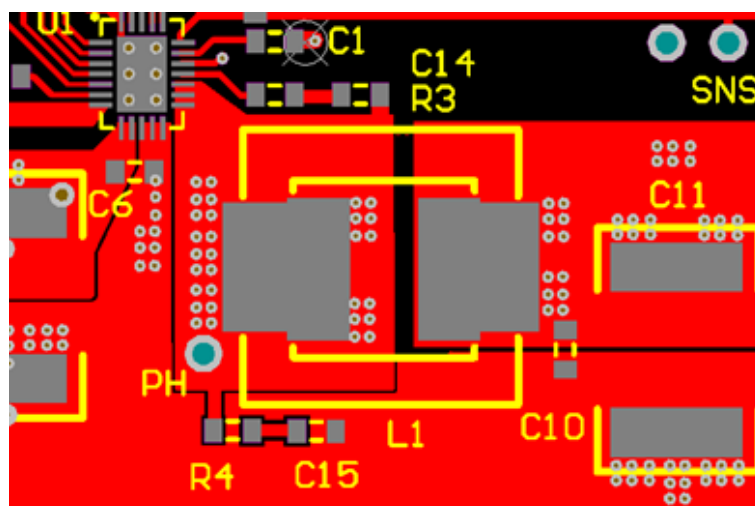

Vias placing

It is crucial to connect very well the ground of the exposed pad of the QFN24L to the ground on the application board. Therefore many vias are necessary to be sure that the parasitic inductor introduced from each via is negligible.

Connect all the ground metallization and/or layers with as many vias as possible. The vias should be located at minimum keepout distance; this should be done to minimize resistive and inductive parasitic effects.

Reference voltage

V_{reg} is generated by an internal LDO. Place a decoupling capacitor very close. Use good capacitor layout techniques. Do not route the V_{ref} trace near noisy traces or planes.

High-side driver supply

V_{DRIVEH} is generated by an internal LDO. Place a decoupling capacitor very close. Use good capacitor layout techniques. Do not route the V_{ref} trace near noisy traces or planes.

Current sensing

With small value sense resistors, trace resistance shared with the load can cause significant errors. It is recommended to connect the sense resistor pads directly to the ISNS+ and ISNS- pins using “Kelvin” or “4-wire” connection techniques as shown in Figure 43. RSNS Kelvin connection (sx sense in the same layer, at dx with vias top to bottom). Run two dedicated traces with decent width in parallel (close to each other to minimize the loop area) from the two terminals of the current-sensing resistor to the IC. Place in the differential mode and avoid sense lines pass through noisy areas, such as switch nodes.

Figure 43. RSNS Kelvin connection (sx sense in the same layer, at dx with vias top to bottom)

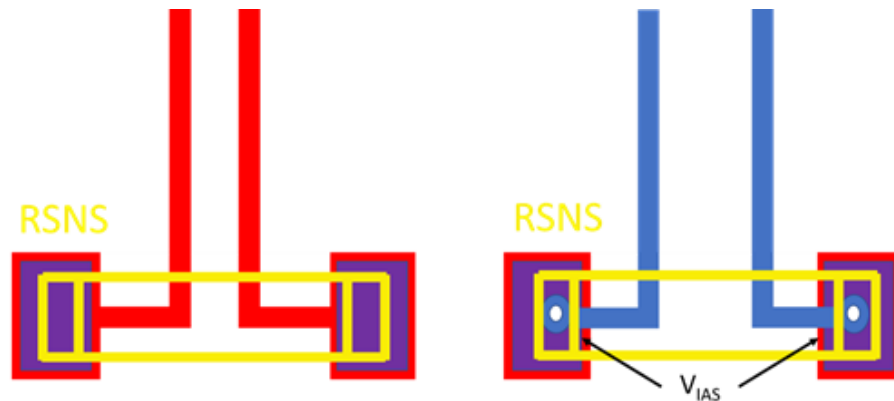

The ISNS+ and ISNS- pins tolerate a DC voltage of -0.3 V with respect to GND. If VISNS+ and VISNS- pins are forecasted to go below the DC value for short AC pulses, the source current must be limited to a max. of 10 mA.

Thermal aspects

The STPD01 power dissipation inside the IC is mainly due to the DC-DC integrated MOSFET power loss. The heat generated due to this power dissipation level requires a suitable heatsink to keep the junction temperature below the overtemperature protection threshold at the rated ambient temperature. Try, where possible, to increase the number of power planes connected, at least below the IC position, to improve the heat dissipation. However, different layouts are also possible. Basic principles suggest keeping the IC and its ground exposed pad approximately in the middle of the dissipating area; to provide as many vias as possible; to design a dissipating area having a shape as square as possible and not interrupted by other copper traces.

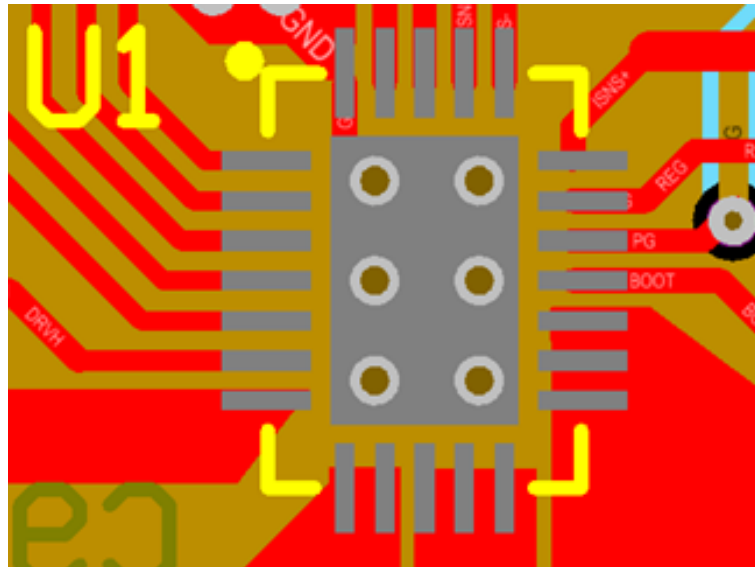
Figure 44. Thermal aspects

9.2 Selecting components for the application

This section provides information to assist in the selection of the most appropriate components for the intended application.

Output capacitor

The output capacitor is very important to satisfy the output voltage ripple requirement. Using a small inductor value is useful to reduce the size of the coil, but this increases the current ripple. Therefore, to reduce the output voltage ripple a low ESR capacitor is required.

The output voltage ripple (V_{OUT_RIPPLE}), in continuous mode, is:

$$V_{OUT_RIPPLE} = \Delta I \times \left(C_{OUT_ESR} + \frac{1}{8 \times C_{OUT} \times F_{SW}} \right) \quad (3)$$

where ΔI is the ripple current and F_{SW} is the switching frequency.

Inductor

The inductor value is very important because it fixes the ripple current flowing through the output capacitor. The ripple current is usually fixed at 20-40% of I_{out_max} , which is 0.6-1.2 A with $I_{out_max} = 3$ A. The approximate inductor value is obtained using the following formula:

$$L = \frac{(V_{IN} - V_{OUT})}{\Delta I} \times T_{ON} \quad (4)$$

where T_{ON} is the ON time of the internal switch, given by $D \cdot T$.

For example, with $V_{OUT} = 5$ V, $V_{IN} = 24$ V, $F_{SW} = 500$ kHz and $\Delta I_{OUT} = 0.8$ A, the inductor value is around 10 μ H.

The peak current through the inductor is given by:

$$I_{PK} = I_{OUT} + \frac{\Delta I}{2} \quad (5)$$

It can be observed that if the inductor value decreases, the peak current (which must be lower than the current limit of the device) increases. So, for fixed peak current protection, a higher value of the inductor allows a higher value for the output current.

Thermal considerations

The dissipated power of the device is given by three separate factors:

- Switching losses due to the $R_{DS(on)}$. These are equal to:

$$P_{HS} = R_{DS(on)} I_{OUT}^2 D \quad (6)$$

and

$$P_{LS} = R_{DS(on)} I_{OUT}^2 (1 - D) \quad (7)$$

where D is the duty cycle of the application.

Note: The duty cycle is theoretically given by the ratio between V_{OUT} and V_{IN}, but in practice it is significantly higher than this value to compensate for the losses of the whole application. For this reason, the switching losses related to the R_{DS(on)} increase compared to an ideal case.

- On and OFF switching losses. These are given by the following relation:

$$P_{SW} = V_{IN} I_{OUT} \frac{(T_{rise} + T_{fall})}{2} F_{SW} \quad (8)$$

where T_{rise} and T_{fall} are the overlap times of the voltage across the power switch and the current flowing into it during the turn-on and turn-off phases.

- Quiescent current losses:

$$P_Q = V_{IN} \times I_{IN} \quad (9)$$

where I_N is the supply current.

$$P_{TOT} = P_Q + P_{SW} + P_{HS} + P_{LS} \quad (10)$$

The junction temperature of the device is:

$$T_J = T_A + R_{thJ-A} \cdot P_{TOT} \quad (11)$$

where T_A is the ambient temperature and R_{thJ-A} is the junction to ambient thermal resistance.

Considering that the device, mounted on the board with a good ground plane, has a thermal resistance junction to ambient (R_{thJ-A}) of about 31 °C/W.

It is also possible to estimate the junction temperature directly from the efficiency measures acquired on a stationary application condition.

Considering that the power losses are given by:

$$P_{LOSS} = P_{IN} - P_{OUT} \quad (12)$$

Neglecting the AC losses of the selected inductor, the power losses are given by:

$$P_{LOSS} = V_{IN} \cdot I_{IN} - V_{OUT} \cdot I_{OUT} - DCR1 \cdot I_{OUT} \quad (13)$$

Therefore, the junction temperature T_J can be calculated as:

$$T_J = T_A + R_{thJA} \cdot P_{LOSS} \quad (14)$$

10 Package information

In order to meet environmental requirements, ST offers these devices in different grades of **ECOPACK** packages, depending on their level of environmental compliance. ECOPACK specifications, grade definitions and product status are available at: www.st.com. ECOPACK is an ST trademark.

10.1 QFN3x4x1.0 24L package information

Figure 45. QFN3x4x1.0 24L package outline

BOTTOM VIEW

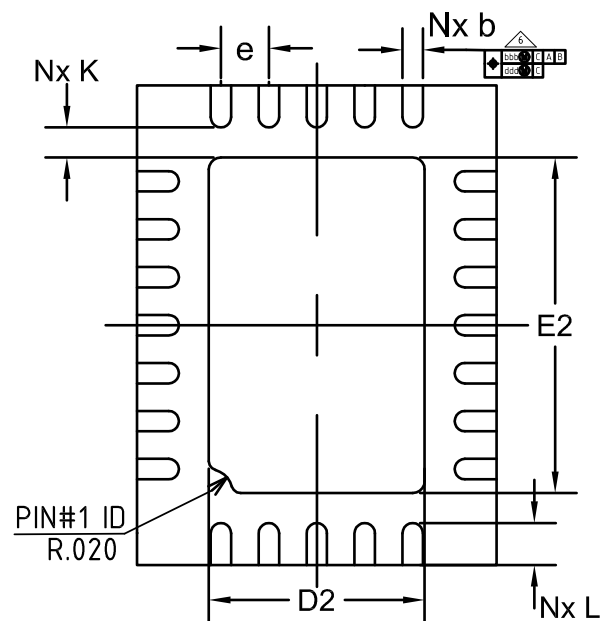

SIDE VIEW

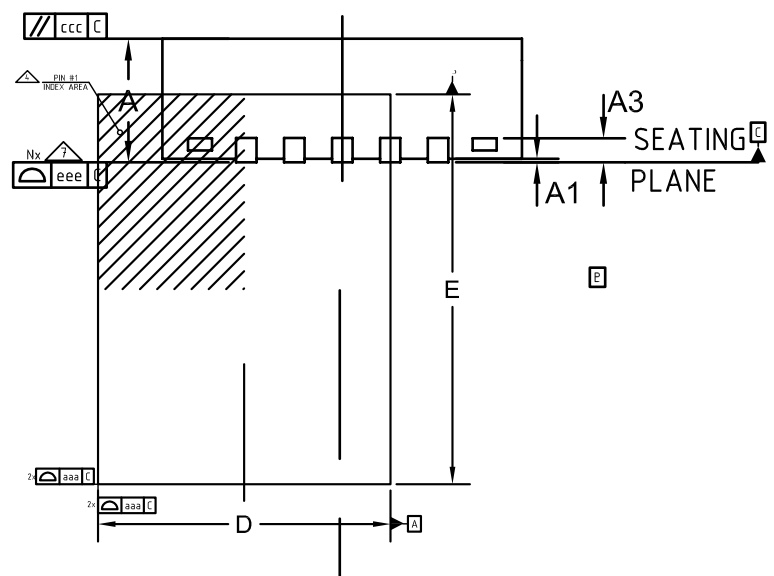

TOP VIEW

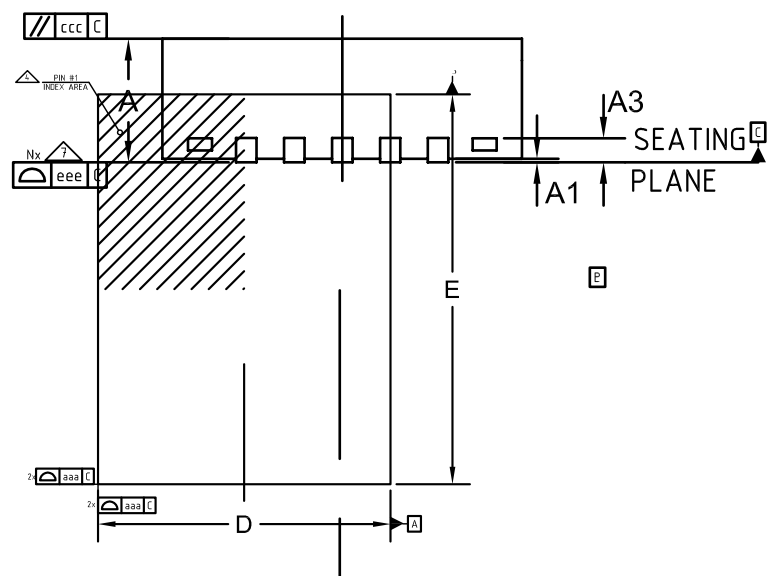
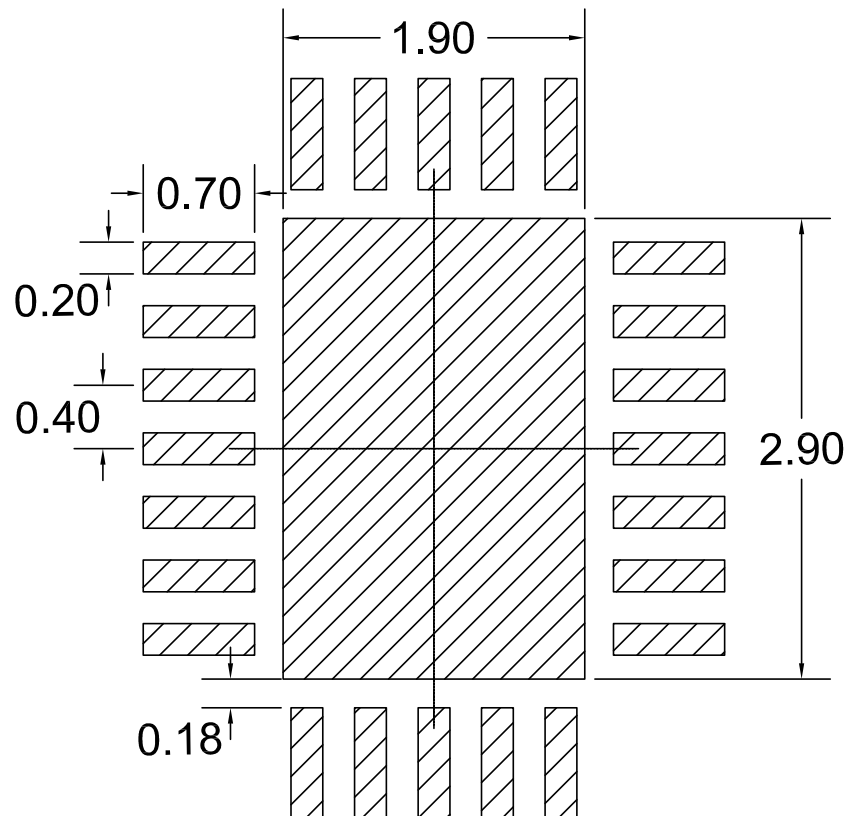

Table 15. QFN3x4x1.0 24L mechanical data

Symbol	mm		
	Min.	Typ.	Max.
A	0.80	0.90	1.00
A1	0.00	0.02	0.05
A3	0.20 REF.		
b	0.15	0.20	0.25
D	3.00 BSC		
E	4.00 BSC		
e	0.40 BSC		
D2	1.65	1.80	1.90
E2	2.65	2.80	2.90
K	0.15		
L	0.25	0.35	0.45
N	24		

Note: *N* is the total number of terminals. Dimension *b* applies to metallized terminal. If the terminal has a radius on its end dimension *b* should not be measured in that radius area.

Figure 46. QFN3x4x1.0 24L recommended footprint



Revision history

Table 16. Document revision history

Date	Version	Changes
02-Oct-2020	1	Initial release.

Contents

1	Application schematic	2
2	Pin configuration (top through view)	3
3	Maximum ratings	5
4	Electrical characteristics	6
5	Block diagram	8
6	Typical performance characteristics	9
7	Operation description	17
7.1	Enable	17
7.1.1	Digital enable	17
7.2	Cable drop compensation	17
7.2.1	Output current monitor	18
7.3	Auto discharge	18
7.4	Power-on	18
7.5	Vout transition	19
7.6	Clock dithering	20
7.7	Programmable watchdog	20
7.8	Protections	20
7.8.1	Overvoltage protection	21
7.9	Interrupt functionality	21
7.10	Switching frequency	21
7.11	Pulse skip	22
7.12	Bus timing	22
7.12.1	Read and write commands	23
7.12.2	I ² C address selection	23
8	Control register description	25
8.1	Register map	25
8.2	Register description	26
8.2.1	Register 0x00	26
8.2.2	Register 0x01	28

8.2.3	Interrupt registers: 0x02, 0x03, 0x04	28
8.2.4	Register 0x05	29
8.2.5	Register 0x06	29
9	Application notes	30
9.1	Board layout guidelines	30
9.2	Selecting components for the application.	33
10	Package information	35
10.1	QFN3x4x1.0 package information.	35
	Revision history	37

List of tables

Table 1.	Bill of material	2
Table 2.	Pin description	3
Table 3.	Absolute maximum ratings	5
Table 4.	Thermal data	5
Table 5.	Recommended operating conditions	6
Table 6.	Electrical characteristics	6
Table 7.	Functional modes	17
Table 8.	Protections	20
Table 9.	I ² C address configuration	24
Table 10.	Configuration bits	25
Table 11.	Register map summary	25
Table 12.	0x00 register description	26
Table 13.	0x01 register description	28
Table 14.	Interrupt register description	28
Table 15.	QFN3x4x1.0 24L mechanical data	36
Table 16.	Document revision history	37

List of figures

Figure 1.	STPD01 typical application schematic	2
Figure 2.	Pin configuration (top through view)	3
Figure 3.	STPD01 block diagram	8
Figure 4.	Efficiency (Vin = Vcc = 24 V, CC = 0x1F, Fsw = 500kHz)	9
Figure 5.	P _{LOSS} (Vin = Vcc = 24 V, CC = 0x1F, Fsw = 500 kHz)	9
Figure 6.	Efficiency (Vin = Vcc = 24 V, CC = 0x1F, Fsw = 750 kHz)	9
Figure 7.	P _{LOSS} (Vin = Vcc = 24 V, CC = 0x1F, Fsw = 750 kHz)	10
Figure 8.	VOUT vs. load (Vin = VCC = 24 V, Vout = 0x64 (5 V), CC = 0x1F)	10
Figure 9.	VOUT vs. load (Vin = VCC = 24 V, Vout = 0xB0 (9 V), CC = 0x1F)	10
Figure 10.	VOUT vs. load (Vin = VCC = 24 V, Vout = 0xD8 (15 V), CC = 0x1F)	11
Figure 11.	VOUT vs. load (Vin = VCC = 24 V, Vout = 0xF1 (20 V), CC = 0x1F)	11
Figure 12.	VOUT vs. load, with cable drop compensation on (Vin = VCC = 24 V, Vout = 0x64 (5 V), CC = 0x1F, R _{cdc2} = 24 kΩ, F _{sw} = 500 kHz)	11
Figure 13.	VCDC vs. load (Vin = VCC = 24 V, Vout = 0x64 (5 V), CC = 0x1F, R _{cdc2} = 24 kΩ, F _{sw} = 500 kHz)	12
Figure 14.	VOUT vs. load, with cable drop compensation on (Vin = VCC = 24 V, Vout = 0x64 (5 V), CC = 0x1F, R _{cdc2} = 6.8 kΩ, F _{sw} = 500 kHz)	12
Figure 15.	VCDC vs. load (Vin = VCC = 24 V, Vout = 0x64 (5 V), CC = 0x1F, R _{cdc2} = 6.8 kΩ, F _{sw} = 500 kHz)	12
Figure 16.	VOUT vs. load, with cable drop compensation on (Vin = VCC = 24 V, Vout = 0xF1 (20 V), CC = 0x1F, R _{cdc2} = 24 kΩ, F _{sw} = 500 kHz)	13
Figure 17.	VCDC vs. load (Vin = VCC = 24 V, Vout = 0xF1 (20 V), CC = 0x1F, R _{cdc2} = 24 kΩ, F _{sw} = 500 kHz)	13
Figure 18.	VOUT vs. load, with cable drop compensation on (Vin = VCC = 24 V, Vout = 0xF1 (20 V), CC = 0x1F, R _{cdc2} = 6.8 kΩ, F _{sw} = 500 kHz)	13
Figure 19.	VCDC vs. load (Vin = VCC = 24 V, Vout = 0xF1 (20 V), CC = 0x1F, R _{cdc2} = 6.8 kΩ, F _{sw} = 500 kHz)	14
Figure 20.	VOUT transition (Vin = VCC = 24 V, Vout = 0x64 (5 V) to 0xB0 (9 V), CC = 0x1F, load = 500 mA, Fsw = 500 kHz)	14
Figure 21.	VOUT transition (Vin = VCC = 24 V, Vout = 0xB0 (9 V) to 0x64 (5 V), CC = 0x1F, load = 500 mA, Fsw = 500 kHz)	14
Figure 22.	VOUT transition (Vin = VCC = 24 V, Vout = 0x64 (5 V) to 0xD8 (15 V), CC = 0x1F, load = 500 mA, Fsw = 500 kHz)	14
Figure 23.	VOUT transition (Vin = VCC = 24 V, Vout = 0xD8 (15 V) to 0x64 (5 V), CC = 0x1F, load = 500 mA, Fsw = 500 kHz)	14
Figure 24.	VOUT transition (Vin = VCC = 24 V, Vout = 0x64 (5 V) to 0xF1 (20 V), CC = 0x1F, load = 500 mA, Fsw = 500 kHz)	15
Figure 25.	VOUT transition (Vin = VCC = 24 V, Vout = 0xF1 (20 V) to 0x64 (5 V), CC = 0x1F, load = 500 mA, Fsw = 500 kHz)	15
Figure 26.	VOUT transition (Vin = VCC = 24 V, Vout = 0x00 (3 V) to 0x64 (5 V) to 0xF1 (20 V), CC = 0x1F, load = 500 mA, Fsw = 500 kHz)	15
Figure 27.	VOUT transition (Vin = VCC = 24 V, Vout = 0xF1 (20 V) to 0x64 (5 V) to 0x00 (3 V), CC = 0x1F, load = 500 mA, Fsw = 500 kHz)	15
Figure 28.	Enable startup (Vin = VCC = 24 V, Vout = 0x64 (5 V), no load)	15
Figure 29.	Enable shutdown (Vin = VCC = 24 V, Vout = 0x64 (5 V), no load)	15
Figure 30.	Digit enable startup (Vin = VCC = 24 V, Vout = 0x64 (5 V), no load)	16
Figure 31.	Digit enable shutdown (Vin = VCC = 24 V, Vout = 0x64 (5 V), no load)	16
Figure 32.	Cable drop configuration	18
Figure 33.	Deglintch time	19
Figure 34.	Transition envelope for positive voltage transitions	19
Figure 35.	Transition envelope for negative voltage transitions	19
Figure 36.	Placement of source bulk capacitance	20
Figure 37.	Data transfer validity	22
Figure 38.	START and STOP commands	22
Figure 39.	Write command	23

Figure 40.	Read command	23
Figure 41.	Capacitor placing	31
Figure 42.	Inductor placing	31
Figure 43.	RSNS Kelvin connection (sx sense in the same layer, at dx with vias top to bottom)	32
Figure 44.	Thermal aspects	33
Figure 45.	QFN3x4x1.0 24L package outline	35
Figure 46.	QFN3x4x1.0 24L recommended footprint	36

IMPORTANT NOTICE – PLEASE READ CAREFULLY

STMicroelectronics NV and its subsidiaries (“ST”) reserve the right to make changes, corrections, enhancements, modifications, and improvements to ST products and/or to this document at any time without notice. Purchasers should obtain the latest relevant information on ST products before placing orders. ST products are sold pursuant to ST’s terms and conditions of sale in place at the time of order acknowledgement.

Purchasers are solely responsible for the choice, selection, and use of ST products and ST assumes no liability for application assistance or the design of Purchasers’ products.

No license, express or implied, to any intellectual property right is granted by ST herein.

Resale of ST products with provisions different from the information set forth herein shall void any warranty granted by ST for such product.

ST and the ST logo are trademarks of ST. For additional information about ST trademarks, please refer to www.st.com/trademarks. All other product or service names are the property of their respective owners.

Information in this document supersedes and replaces information previously supplied in any prior versions of this document.

© 2020 STMicroelectronics – All rights reserved